

# COMMISSION OF THE EUROPEAN COMMUNITIES

COM(76) 171 final/2.

Technical annexes

Brussels, 11 May 1976.

MULTIANNUAL PROGRAMME OF THE  
JOINT RESEARCH CENTRE  
DETAILED TECHNICAL PROPOSAL  
1977 - 1980

---

(submitted to the Council by the Commission)

This document contains the detailed technical proposals for the ten programmes forming the multiannual research programme of the JOINT RESEARCH CENTRE for the period 1977 - 1980.

COM(76) 171 final/2..

Technical annexes

## 1. REACTOR SAFETY

APPENDIX E-I-01

PROGRAMME :

REACTOR SAFETY

TABLE OF CONTENTS

INTRODUCTION

1. PROJECT : RELIABILITY AND RISK ASSESSMENT

1.1. BACKGROUND

1.2. TECHNICAL DESCRIPTION

1.2.1. Acquisition and evaluation of codes for mechanistic accident analysis

1.2.2. LWR core accident probabilistic analysis

1.2.3. Set-up of a european reliability data system

1.3. PLANNING

1.4. MANPOWER AND COSTS

1.5. COLLABORATION WITH EXTERNAL ORGANIZATIONS

2. PROJECT : LIGHT WATER REACTOR LOSS OF COOLANT ACCIDENT  
OUT OF PILE STUDIES AND IN PILE STUDIES

2.1. OUT OF PILE STUDIES

2.1.1. Background

2.1.1.1. Separate effects and/or component behaviour tests

2.1.1.2. Systems thermalhydraulics tests

2.1.2. Technical description

2.1.2.1. Loop blowdown project, programme A(1) and B(2)

2.1.2.2. Blowdown code validation and development ; basic theoretical  
support to the blowdown project

2.1.2.3. Basic experimental support to blowdown

a) Experimental investigation of the heat transfer crisis in  
blowdown conditions

b) Hydraulic Oscillation Experiments

c) Two phase mass flow through convergent nozzles

- d) Development of a mass flow NMR measurement
- 2.1.2.4. Thermohydraulic fuel bundle behaviour during LOCA
  - a) Development and validation of computation models for transient fuel bundle behaviour during LOCA
  - b) Experimental studies on rod bundle heat transfer during LOCA
- 2.1.3. Planning
- 2.1.4. Manpower and costs
- 2.1.5. Collaboration with external organizations
- 2.2. IN-PILE STUDIES
  - 2.2.1. Background
  - 2.2.2. Proposed in-pile experimental Programme - Schematic description
    - 2.2.2.1. Preliminary exercise = exploratory "Fuel Failure" capsule experiment
    - 2.2.2.2. COFAS loop exercise 1 = fuel behaviour in power/cooling mismatch (PCM) conditions
    - 2.2.2.3. COFAS loop exercise 2 = fuel behaviour following a gross inlet blockage
    - 2.2.2.4. COFAS loop exercise 3 = fuel behaviour in loss-of-collant accident (LOCA) condition
      - a) Blowdown
      - b) Refill, reflood and/or spray cooling
      - c) Complete LOCA simulation
    - 2.2.2.5. Analytical support
  - 2.2.3. Proposed actions for the 1977-1979 period
- 2.3. MANPOWER AND COSTS
- 3. PROJECT : LIQUID METAL FAST BREEDER SUBASSEMBLY THERMOHYDRAULICS
  - 3.1. BACKGROUND
    - 3.1.1. Single phase fuel rod bundle temperature fields
    - 3.1.2. Temperature noise
    - 3.1.3. Basic sodium boiling phenomena
    - 3.1.4. Sodium boiling in rod bundles
  - 3.2. TECHNICAL DESCRIPTION
    - 3.2.1. Code development and validation for rod bundle thermohydraulics

- 3.2.1.1. Fault conditions due to geometrical anomalies
- 3.2.1.2. Thermal fuel sub-assembly transients
- 3.2.2. Early warning techniques based on temperature noise analysis
  - 3.2.2.1. Fuel element failure detection and identification
  - 3.2.2.2. Boiling detection for in-pile blocked fuel element experiment
  - 3.2.2.3. Noise detector development
  - 3.2.2.4. Experimental devices
- 3.2.3. Studies on the dynamics and basic characteristics of sodium boiling in subassembly configurations
  - 3.2.3.1. Experimental and theoretical investigations on the influence of uniform and non-uniform heat flux distribution on the boiling behaviour in a simple geometry
  - 3.2.3.2. Behaviour of porous blockages in fast breeder sub-assemblies
  - 3.2.3.3. Cluster boiling experiments in small bundle geometry
- 3.3. PLANNING
- 3.4. MANPOWER AND COSTS
- 3.5. COLLABORATION WITH EXTERNAL ORGANIZATIONS

#### 4. PROJECT : FUEL COOLANT INTERACTIONS AND CORE MELT DOWN

- 4.1. BACKGROUND
- 4.2. TECHNICAL DESCRIPTION
  - 4.2.1. Fuel coolant interactions
  - 4.2.2. Core melts, post accident heat removal
    - 4.2.2.1. Basic studies
      - a) Material properties
      - b) Behaviour of irradiated fuel rods during melt down
      - c) Heat transfer studies
      - d) Thermomechanical behaviour of core-melt barriers
    - 4.2.2.2. Integral tests
- 4.3. PLANNING
- 4.4. MANPOWER AND COSTS
- 4.5. COLLABORATION WITH EXTERNAL ORGANIZATIONS

#### 5. PROJECT : DYNAMIC STRUCTURE LOADING AND RESPONSE

- 5.1. BACKGROUND
- 5.2. TECHNICAL DESCRIPTION
  - 5.2.1. Code development and validation

5.2.2. Determination of material constitutive laws

5.3. PLANNING

5.4. MANPOWER AND COSTS

5.5. COLLABORATION WITH EXTERNAL ORGANIZATIONS

6. PROJECT : STRUCTURAL FAILURE PREVENTION

6.1. BACKGROUND

6.2. TECHNICAL DESCRIPTION

6.2.1. Failure genesis

6.2.1.1. Crack instability and embrittlement effects in LMFR structures

6.2.1.2. Fatigue/creep crack growth in stainless steel structure

6.2.1.3. Study of microscopic processes of crack growth and instability

6.2.1.4. Creep damage modelling

6.2.1.5. Probabilistic modelling of stress corrosion damage

6.2.2. Failure detection

6.2.2.1. Application of the ultra-acoustic emission to the detection characterization and location of cracks and leaks

6.2.2.2. Reliability of conventional non-destructive techniques

6.3. PLANNING

6.4. MANPOWER AND COSTS

6.5. COLLABORATION WITH EXTERNAL ORGANIZATIONS

## APPENDIX E-I-01

## PROGRAMME

REACTOR SAFETYINTRODUCTION

The expanding electrical energy needs in the Community can be met in the greater part only by an increase of the number of nuclear power plants.

This, together with the increased sensibility of the public feeling towards the safety aspects of nuclear power installations, and its reflection on the licensing process, has been the most general motivation for a continuous increase of this activity in the JRC. The proposals of the JRC Reactor Safety Programme take into account :

- the recommendation of the ACMP-Safety, which gave the indications of the research necessities in this field in the different member countries and the Community (see Doc. ACS-51-e);
- the existing and developing competence of the JRC in this field;
- the outcome of the discussions and collaboration with the different international committees involved in the reactor safety research where the constructors, the licensing authorities and the utilities are represented;
- the support given to the reactor safety programme of the JRC by contracts with external bodies.

The proposed programme involves activities in the field of Light Water Reactors (LWRs) and Liquid Metal Cooled Fast Breeder Reactors (LMFBRs).

- a) The major accident to be considered in a Light Water Reactor is a severe loss of coolant due to the rupture of the primary circuit and the consequent blowdown.

Questions to be answered in this area are : What degradation of cooling does the core have to tolerate and what is the consequent behaviour of the cladding temperature ? Does the emergency core cooling system (ECCS) provide sufficient compensatory cooling or does the ECCS water fail to enter the core ? How does the rupture size and position and the response of the primary circuit affect the answer to these questions ?

In the case of imagined ECCS failure and wide-spread core melting, what is the behaviour of the core-melt ?

The Ispra contribution to this problem is mainly centered around the loop blowdown project which simulates blowdown conditions in a four-loop primary cooling system of a 1300 MWe PWR. Theoretical studies involving the acquisition and comparison of existing blowdown codes are proposed to support the experimental project. Basic experimental support using simple facilities is also provided.

Investigations on the fuel-coolant interaction and on the control of molten core debris are also part of the programme.

Furthermore, a proposal is being made for in-pile safety studies in the ESSOR-reactor where the behaviour of fuel pins and bundles in a variety of accident conditions will be investigated.

- b) The basic feature of LMFBR safety is the fact that compaction of the core - or part of it - may lead to an increase of reactivity above the prompt critical state, the initiation of an uncontrollable nuclear excursion and the generation of an explosive energy release. The chain of events to be investigated includes : the loss of heat transfer in subassemblies due to blockages, structural deformation, local sodium boiling leading to fuel pin overheating and rupture ; the wide-spread subassembly damage and fuel melting with consequent fuel/coolant interaction ; the fuel compaction and prompt critical excursion ; the post-accident heat removal and the control of molten-core debris ; the explosive loading of the reactor vessel, internal structures and primary circuit.

The Ispra contribution in this field involves both theoretical and experimental studies in the field of sodium thermohydraulics, fuel/coolant interaction, control of molten core debris, dynamic structure loading and response.



- c) Special emphasis is given in the proposed programme to the theoretical assessment of reliability and risk. This activity is aimed principally at developing a probabilistic approach to the assessment of LWR safety.  
It includes also the development of a "European Whole Core Accident Code", sponsored by the "Safety Working Group of the European Fast Reactor Coordinating Committee".
- d) Finally, a special chapter is devoted to the structural failure prevention which includes material research on crack growth and fracture mechanics and the development of early failure detection techniques.

The proposed activities are grouped into six projects :

- Reliability and Risk Assessment,
- Light Water Reactor Loss of Coolant Accident. In and out of Pile Studies,
- Liquid Metal Cooled Fast Breeder (LMFBR) Subassembly Thermohydraulics,
- Fuel-Coolant Interaction and Core Melt-Down,
- Dynamic Structure Loading and Response,
- Structural Failure Prevention.

For each project the following information is given :

- Background
- Technical Description of the Activity
- Planning
- Manpower and costs
- Collaboration with external organizations

It must be mentioned here that a part of the new manpower required for the execution of the proposed programme should be recruited from outside because the necessary competence is not available within the JRC.

#### CONNECTIONS WITH "INDIRECT ACTIONS"

At present no indirect actions exist in the framework of the Reactor Safety Programme. The Commission endeavours to coordinate the national efforts in this field through a number of Expert Groups in which the JRC actively participates.

The following groups exist at the present time :

- Safety of Light Water Reactors (CCE)

Working Group Nr. 1 : Methods, Codes, Criteria and Standards,

Working Group Nr. 2 : Research Programmes.

- Fast Reactor Coordinating Committee (CCE)

LMFBR Safety Working Group,

- Whole Core Accident Codes,

- Containment Loading and Response.

- ACMP - Safety (CCE-JRC)

Blowdown Part B,

LMFBR Subassembly Fault Analysis,

Reliability,

Core Melt-Down and Fuel-Coolant Interaction,

Structural Failure Prevention.

- CSNI (OECD)

Working Group on Mechanical and Material Problems Relating to  
Safety Aspects of Steel Components in Nuclear Plants;

Liquid Metal Boiling Working Group,

European Two-Phase Flow Group,

European Working Group "Acoustic Emission".

SUMMARY OF MANPOWER AND COSTS

PROGRAMME : REACTOR SAFETY							
	Research Staff (per year)	Investments (M.U.A.)	Total Running Expenditures (M.U.A.)	Resources (M.U.A.)	Required Budget (M.U.A.)	Expected Income (M.U.A.)	
<u>PROJECT 1</u> RELIABILITY AND RISK ASSESSMENT	25	---	0.390	---	0.390	---	
<u>PROJECT 2</u> LIGHT WATER REACTOR LOSS OF COOLANT ACCIDENTS-OUT/IN PILE STUDIES	72	1.350	5.650	---	7.000	0.700	
<u>PROJECT 3</u> LIQUID METAL FAST BREEDER SUBASSEMBLY THERMOHYDRAULICS	30	0.570	1.130	---	1.700	---	
<u>PROJECT 4</u> FUEL-COOLANT INTERACTIONS AND CORE MELT DOWN	40	0.850	1.900	---	2.750	---	
<u>PROJECT 5</u> DYNAMIC STRUCTURE LOADING AND RESPONSE	32	0.500	1.780	---	2.280	---	
<u>PROJECT 6</u> STRUCTURAL FAILURE PREVENTION	40	0.530	1.870	---	2.400	---	
<b>TOTALS</b>	239	3.800	12.720	---	16.520	0.700	

# 1. PROJECT : RELIABILITY AND RISK ASSESSMENT

## 1.1. BACKGROUND

The action is aiming to develop a probabilistic approach to the assessment of the LWR Safety.

In the reactor safety analysis a deterministic approach has, up until now, been predominant. But in the last years it has been generally recognized that the deterministic approach is insufficient and pilot studies based on probabilistic methods have been promoted by various governmental organisations (Wash 1400 concerning PWR, BWR in USA, 1972-1976); ASPA concerning HTR in USA, 1974-1979; Swedish Study on siting, 1972-1974; BMFT Project "Risk and Reliability" ; KEMA Study on siting, 1974-1975; etc.).

The main justifications for these studies arise from the following two facts :

- 1.1.1. nuclear safety is now concerned with four main "influencing groups" : public, licensing authorities, manufactures, utilities. The attitude of the various groups can be different in various countries. However, the balance of power is changing in favour of the public.
- 1.1.2. the investment in research related to nuclear safety is continuously increasing so that an optimization of the use of available information and a decision as to the guidelines for further research efforts is strongly desired.

The above mentioned pilot studies extensively use methods and data coming from the nuclear and non nuclear field. But in spite of the impressive effort spent in such studies the results are a long way from being completely satisfactory as the debate on the Rasmussen Report has shown (see for instance the minutes of the Meeting of the LWR safety Working Group Brussels, 14 March 1975). In fact, a full scale and satisfactory application of the probabilistic approach to safety still requires a long term effort.

During the actual pluriannual programme Ispra has given relevant contributions to this effort by methodological developments and pilot applications in collaboration with national organizations and the Commission Services. The continuation of this activity during the next pluriannual programme is motivated by various reasons :

- the long-term character of this research,
- the need of complementing the parallel experimental activities proposed in the safety programme with an adequate capacity for the analysis and evaluation of complex safety related chains of events,
- the need of a jelling point for various safety analysis methods, and specific probabilistic methods being developed in Europe in order to help in reaching a unified European approach,
- the typical international character of certain initiatives such as the setting up of a Reliability Data System,
- the need of technical support for the Commission in its effort to harmonize the licensing procedures in Europe (ref. COM 75/60 final).

## 1.2. TECHNICAL DESCRIPTION

The action proposed for the future pluriannual programme will be mainly focused on the probabilistic analysis of the accident chains leading to a core disruptive accident to cope at some extent with the parallel experimental projects proposed in the safety programme.

Considering the state of the art in the domain of the probabilistic safety, the action will involve development and coupling of methods, both mechanistic and probabilistic, pilot applications to some reference designs and validation of the methods by comparison with the experience of some abnormal occurrences in plant operation in Europe.

The connections with the national activities should be ensured primarily through the LMBFR and LWR Safety Working Groups in Brussels.

The action will be divided into three activities :

The first activity consists of the acquisition and evaluation of codes for mechanistic accident analysis in LMBFR and LWR. The scope of this activity to be initiated in the JRC is not only represented by the acquisition of some tools necessary to perform the further steps in probabilistic accident chain analysis but also impinges on the need for a critical review of the various physical models adopted.

Indeed, many models and codes that are presently available are not thoroughly understood outside the organizations in which they were evolved.

Furthermore, many of the codes have not been critically compared against other codes with comparable capabilities, or with methods of analysis.

An independent assessment and a comparison of the results is therefore highly desirable.

Finally, of particular interest is the intercoupling of modules for the LMFBR whole core accident : the justification for this action stems from a direct request by the WAC Experts Group to Ispra.

The second activity will consist of a probabilistic analysis of LWR core accidents.

This activity will develop a probabilistic approach to describe the spectrum of possibilities of complex phenomena involved in core accidents. In the analysis of accident progression two main steps are considered : the system degradation step and the core disruption step.

The first step is of pre-eminent relevance for operational safety (normal operation). However, the degradation paths can widen the range of the initiating fault conditions for the following disruptive accidents and can therefore widen the range of the final risk.

The third activity will consist of setting up, on a collaborative basis a reliability data system specifically for LWR reactor components.

#### 1.2.1. Acquisition and Evaluation of Codes for Mechanistic Accident Analysis

The initial phases of this study are the review of existing modelling capabilities and the definition of the model requirements for accident analysis. Once the most suitable codes are stored in the JRC computer, a phase of evaluation and intercomparison of these will be started : if it is felt necessary, work on coupling the different models and on improving the codes themselves will also be achieved.

A typical example of this activity will be represented by the implementation in Ispra of the modular code for the study of the whole core accident in a LMFBR asked for by the WAC Experts Group. Similar activities could also be carried out for LWR.

The need to improve the mechanistic codes arises from the fact that up until now the codes have been developed and used with reference to extreme situations (DBA). The spectrum of consequences (over pressures, over temperatures, etc.) for all the possible relevant situations, in the majority of cases, cannot be tackled with the existing tools.

In general, four types of models will be treated in this study : neutronic models, component and subsystem models, physical and chemical models, and global system models.

The neutronic models are aimed at a description of the full range of core transients and will include thermohydraulic calculations as required. After heat removal is therefore a subject of interest in this area.

Separate component and subsystem models will be considered for items of particular safety significance in the system; for example one can mention steam generators, ECCS, pumps, containments, core structures, etc.

Several types of physical and chemical processes must be included in the modelling of the various reactors : a few examples are sodium and water boiling, MFCI, molten fuel slumping, corium behaviour, etc.

Ultimately, the model in the fourth category should include as much of the plant as possible, with as much detail in individual areas as is practicable : therefore these global models will usually avoid highly detailed treatments of the most complex processes : examples of this type of code are the modular FRAX and CAPRI for the study of LMFBR.

#### 1.2.2. LWR Core Accident Probabilistic Analysis

The activity will cover areas of the risk analysis of LWR which are particularly critical or which are not, or insufficiently, covered by the studies carried out up to now in Europe or the USA. Such areas are :

- Probabilistic analysis of some initiating events, such as pressure vessel and primary piping failure.
- Probabilistic analysis of core degradation, i. e. evaluation of the probabilistic distribution of temperature and other coolant parameters in various points of the core and with time, in normal and in blowdown conditions.
- Probabilistic modelling of various accidental paths to core melt down and radioactivity release.

The solution of the mentioned problems involves a large amount of basic method developments. In particular it will involve :

- the development of an integrated and modular software for probabilistic transients analysis starting from the actual step by step approach

- the development of non numerical heuristic techniques for complex tree manipulation. This development intends to extend and facilitate the application of graph analysis (event-tree fault-tree) to systems with complex evolution with time and with dependencies at various levels
- development of techniques for automatic fault-tree analysis starting from functional relationships
- the development of approaches for analysing highly correlated structures such as the vessel and piping.

In the frame of this activity, and in parallel with the mentioned study at "design" level, some "validation" pilot tests should be carried out.

Such tests will consist of an analysis "a posteriori" of some abnormal occurrences and transients experiences in operating LWR.

### 1. 2. 3. Set-up of a European Reliability Data System

Throughout Europe and the USA several data collection systems exist concerning reliability in non nuclear fields. However, in general, the use of data outside a special field, where they have been collected, appears to be very doubtful.

Ref. : Conclusions of the European Reliability Data Seminar held in Stockholm in October 1973.

Moreover, for a large part of the components in nuclear reactors, data is completely lacking. This situation stresses the need to make the best use of the information coming from the reactors in operation in Europe.

In 1973-1974 the United States Nuclear Plant Data System has been developed and implemented.

In Europe some efforts have been made but only on a national basis.

The dimensions of the problem and its relevance for the European nuclear industry suggests a solution on a community basis. The initiative should be based on a co-operative effort between the Industry Directorate of the CEE, the JRC and the various national organizations already involved in this type of effort. The data should concern components of existing commercial reactors, i. e. of LWR.

The activity foresees various steps :

- state of the art and feasibility study (this preliminary work can be carried out in the actual pluriannual programme).
- Set up of a Steering Committee including representative from electric utilities, nuclear steam system suppliers, and national licensing authorities, which should orient the JRC task force to define a Reporting Procedures Manual.



- Pilot programme on a few nuclear units (four)
- Implementation of the programme throughout the nuclear power industry.

### 1.3. PLANNING

See table E-I-01/a

### 1.4. MANPOWER AND COSTS

PROGRAMME : REACTOR SAFETY				
PROJECT 1 : RELIABILITY AND RISK ASSESSMENT				
	1977	1978	1979	1980
RESEARCH STAFF	25	25	25	25
INVESTMENTS (K.U.A.)	--	--	--	--
RUNNING COSTS (K.U.A.)	50	60	70	80
CONTRACTS (K.U.A.)	←----- 130 -----→			

### 1.5. COLLABORATION WITH EXTERNAL ORGANIZATIONS

CNEN -  
 GBRA - Bruxelles  
 CESNEF - Milano  
 CISE - Milano  
 CEA - Saclay, Cadarache  
 KEMA  
 RCN - Petten  
 KFK - Karlsruhe  
 UKAEA - Risley  
 FRAMATOME - Paris  
 CNR - Milano  
 ENEL - Milano  
 ULB - Bruxelles

**PLANNING**

Action	1977	1978	1979	1980
1 WAC - step 1				
WAC - step 2				
Codes for LWR transients in non DBA				
2 Pressure vessel failure				
Core degradation				
Modelling of core melt down				
Validation on existing plants				
3 State of the art				
Set-up of a steering committee				
Pilote programme				
Decision and set up for general implementation				

## 2. PROJECT : LIGHT WATER REACTOR LOSS OF COOLANT ACCIDENT OUT OF PILE STUDIES AND IN PILE STUDIES

### 2.1. OUT OF PILE STUDIES

#### 2.1.1. Background

The loss of coolant due to a primary cooling circuit rupture is considered to be the worst LWR accident. The main consequence of such an accident is the fuel cladding temperature increase due to the degradation of core cooling, which can finally lead to a cladding rupture and a release of radioactive material. To prevent such consequences it has to be proven that :

- a given threshold for a maximum admissible cladding temperature will not be exceeded
- the cladding temperature increase during a LOCA and the ECCS operation remains controllable.

The two main approaches to reach this goal are :

- the provision of a supplementary coolant by means of ECCS
- the improvement of the understanding of fluid flow and heat transfer mechanisms occurring within the core region during a LOCA.

Both approaches require experimental and theoretical investigations in the field of transient thermalhydraulics. Such investigations represent a large part of reactor safety research programmes already underway for several years in many countries over the whole world.

For about 10 years activities at Ispra in the field of thermalhydraulics have also increasingly contributed to these efforts.

The previously existing knowledge and correlations for describing heat transfer and fluid flow mechanisms have been obtained mainly from investigations under steady-state conditions. Their application to the highly complex and transient mechanisms occurring within a reactor core during a LOCA is therefore questionable. To satisfy the strong need for extending the validity range and/or improvement of the existing correlations describing transient thermalhydraulic mechanisms, mainly two different classes of investigations have been set up :

- separate effects and/or component behaviour tests
- systems thermalhydraulics tests.

Their final objective is :

- the development and validation of best estimate models and correlations
- to obtain the best data possible which is required to verify the applicability of these correlations to LWR safety analysis.

The activities in the field LOCA thermalhydraulics, proposed for the next pluriannual reactor safety research programme of the Ispra Establishments, are concerned with both types of investigations.

2.1.1.1. Separate effects and/or component behaviour tests are aiming mainly at a more fundamental investigation of more or less single phenomena. The Ispra activities proposed in chapt. 2.1.2.3. and 2.1.2.4. are intending to contribute mainly the following three out of about 8 such problem areas :

- blowdown heat transfer studies
- transient CHF (critical heat flux) and post CHF heat transfer studies
- thermalhydraulic interactions between subchannels.

More or less important research programmes, already underway mainly in the USA, are dealing with these three problem areas, covering a rather wide parameter range as far as pressure, mass flow, density and temperature transients on the one hand, and different flow geometries (circular, annular and rod bundles) on the other are concerned. (See table E-I-01/b).

The special interest of the proposed Ispra activities regarding the first two items is given by the fact, that the BOWAL facility allows an extension of those investigations into ranges beyond the normal operation pressure and temperature. This region is of special importance in connection with so-called ATWS (Anticipated Transients Without Scram) problems.

The required theoretical and experimental work (third item, chap. 2.1.2.4. concerned with subchannel analysis and the development of corresponding computer codes is done by groups which have already been working in this field many years and which during the last few years have increasingly oriented the objective of their work towards transient and two-phase flow phenomena. The very close co-operation of these groups which to our knowledge is not existing to such an extent in other laboratories will assure a highly appreciable completion of these investigations.

## SEPARATE EFFECTS TESTS/MODEL DEVELOPMENT\*

Objective	USA	France	Germany	GB	Italy	Ispra
Blowdown heat transfer	- ORNL-Oak Ridge - Semiscale-INEL - Columbia Univ. New York - GE	- C.E.N.-Grenoble	- KWU-Grosswelzh. - GKSS - TU-Hannover	- CEGB - AWRE	- CISE	- BOWAL - DHT-1 - (LOBI)
Transient CHF, post CHF HT studies	- ANL; - W; - B&W; - CE; - Exxon; - MIT; - NWU; - Lehigh Univ.	- C.E.N.-Grenoble	- KWU-Grosswelzh.		- CISE	- BOWAL - DHT-1 - (LOBI)
Reflood rate and HT	- W-NRC - GE - MIT - EPRI - Semiscale	- C.E.N.-Grenoble	- KWU-Erlangen	- CEGB		- BOWAL - (LOBI)

\* no claim for completeness

SYSTEM THERMALHYDRAULICS TESTS FOR BLOWDOWN COMPUTER CODES CHECKING & IMPROVEMENT\*

	U S A		Japan ROSA II J AERI	Europe LOBI BMFT-CEC-Ispra
	Semiscale INEL-ANC	LOFT INEL-ANC		
Reference plant	1000 MW <sub>e</sub> - LPWR		1000 MW <sub>e</sub> - LPWR	
Scale	1 : 1800	1 : 60/30	1 : 500	1 : 700
Loops	2 1 active 1 non-active	2 1 active 1 non-act.	2 active	2 active
Heating	electrical indirect	nuclear	electrical indirect	electrical direct
Power	1.6 MW	50 MW	2.5 MW	5.5 MW
Heater rods	40	1200	109	64
Radial power distr.	2 zones	real	2 zones	constant
Length of HT surface	5.5/12 (ft)	5.5/12 (ft)	4/12 (ft)	3.9/3.9 (m)
ECCS	Acc.	Acc., HP, LP	Acc.	Acc.
ECCS water injection position	cold leg	cold leg	cold leg	cold leg hot leg upper plenum

\* No claim for completeness

- 2.1.1.2. Systems thermalhydraulics tests are aiming at the investigation of the influence of the behaviour of the different components on the behaviour of the whole of the circuit system under depressurization and loss of coolant conditions.

Four research projects in the world are concerned with investigations of this kind, see table E-I-01/c. The LOBI (Loop Blowdown Investigations) project at Ispra is unique in Europe. It will be partially performed in the framework of a R & D contract between the BMFT-Bonn and the Commission of the EC. Its design and programme reveals two main features not existing in the other similar projects and therefore cover an essential gap : the full length of heat transfer surfaces and the ECC water injection also into hot leg and upper plenum.

The main objective of this investigation is to check and improve blowdown computer codes.

Furthermore the activity proposed in chapt. II.2 is concerned with work not envisaged to such an extent elsewhere, and at the same time typical for an international research institute : the validation of the most important and most suitable blowdown computer codes, with the aim of providing a public service for the Community.

Finally there are proposed three activities concerned with the development of measuring methods, which is an essential need to be satisfied in view of the experimental investigations in this field.

## 2.1.2. Technical description

### 2.1.2.1. Loop blowdown project, programme A(1) and B(2)

The LOBI (Loop Blowdown Investigations) project as one of the main activities within the Ispra Safety Research Programme was started in January 1974, and will be performed mainly in the framework of a four year R & D contract between the BMFT-Bonn and the Commission of the European Communities.

Hence, contractual work, being concerned with the design and construction of a large blowdown loop system and the performance of loss of coolant investigations (programme A) have to be continued up until October 1978, taking into account a 10 month delay already accumulated up to now.

Thereafter, a similar programme B (Community programme) of at least one year's duration defined by experts of the member countries, will be performed on the same or slightly modified test rig.

The experiments to be carried out with this two loop system, simulating a four loop primary cooling system of a 1300 MWe PWR, are dealing with the investigation of LPWR LOCAS caused by tube ruptures of different rupture sections at different positions within the primary cooling systems of the reactor, also taking into account the intervention of different ECCS. s.

The results will be used for checking and improving blowdown computer codes and associated theories for safe analysis of PWR's.

The work for the LOBI project to be performed during the next four year programme will be concerned with the following main tasks :

Task 1 - Step by step commissioning of the whole loop system, particularly of the measurement instrumentation and the signal conditioning and data acquisition system

Testing of mini-computer programme for :

- controlling electrical power (heat) input to the rod bundle
- controlling the pump speed as a function of time during blowdown
- data acquisition, reduction and representation
- rough data evaluation (balances, etc.)

Performance of a series of preliminary tests aimed at

- checking the steady state thermal-hydraulic characteristics of the test rig
- isothermal and adiabatic blowdown experiments (hot wall tests, etc.) with and without ECC operation.



Testing of computer programmes for the evaluation of separate thermal-hydraulic effects and of blowdown components

Evaluation of preliminary tests.

Task 2 - Pre-prediction calculations of test facility blowdown experiments with RELAP 4 code for programme A

Ditto for programme B

Determination, by RELAP 4 code calculations, of pump speed control time function

Task 3 - Performance of programme A experiments : 54 (plus 6) blowdown tests aiming at the investigation of the influence of different component operation conditions on blowdown in dependence of rupture section and position.

Evaluation of programme A test results with respect to

- separate thermal-hydraulic effects
- influence of thermal-hydraulic behaviour of LPWR circuit components and ECCS operation on blowdown
- comparison with calculation results from RELAP 4 code
- checking and improving of separate modules and/or hypotheses of RELAP 4 computer codes as well as of the integral RELAP 4 code.

Task 4 - Performance of programme B experiments : repetition of 7 programme A tests as reference tests for a series of blowdown tests (to be defined during 1976) aiming at the investigation of the influence of different component sizes and/or elevation and of further rupture positions and ECC water injection positions on blowdown.

- Evaluation of programme B test results, see Task 3.

2.1.2.2. Blowdown code validation and development; basic theoretical support to the blowdown project

The advisory Committee of the Safety Programme has expressed several times the strong interest of the Member states in an intensification of the blowdown-code work with the aim of providing a public service for the Community and to accompany the experimental activity at Ispra.

- To acquire a good working knowledge of the scope and the limitations of the major blowdown/ECC code test calculations - especially with RELAP 3, THETA-1B, KAPCOR and/or BRUCH-D will be made ;
- Comparison of the main codes with experimental results to demonstrate their various abilities to predict real situations ;
- Fundamental improvements in the physical theory and numerical methods used by the more promising of the codes, or for alternatively to develop a completely new code with the required capabilities ;
- Contribution to the survey calculations for the version B of the blowdown loop to uncover the most effective parameter variations for the definition of the test matrix of programme B.

### 2.1.2.3. Basic experimental support to blowdown

#### a) Experimental investigation of the heat transfer crisis in blowdown conditions

Present blowdown codes calculate the DNB on the heater rod surface with relations obtained from steady state experiments. This leads to extremely conservative results, i. e. the calculated cladding temperatures are much higher than those obtained in blowdown experiments. In order to improve the codes upon this point it is desirable to know quantitatively the time dependent influence of such parameters as mass-flow, pressure, heat flux and geometry.

For the proposed work two experimental facilities already exist (DHT 1 and BOWAL-loop) which can be used for these investigations after small modifications of the measurement equipment.

DHT 1 : - pressure up to 150 bars  
 - power 180 kW  
 - natural convection/open blowdown facility  
 - extremely small wall thickness of the test-section (geometry influence)

With this facility the investigation of complete flow-stoppage after rupture simulation can be carried out.

BOWAL : - pressure up to 250 bars  
 - power 3.6 MW  
 - closed loop with circulation pump of 100 m<sup>3</sup>/h and valve for partial depressurization  
 - single tube test section of different geometries.

The facility BOWAL allows the investigation of the influence of partial mass-flow and pressure variation on the DNB-delay and rewetting process.

As regards the influence of cluster configurations, a literature study will be made to decide whether subsequent tests with bundle geometries are worthwhile.

#### b) Hydraulic Oscillation Experiments

Experimental assessment of the applicability of the momentum equation in the nodal approach of the blowdown codes. From the three basic equations, describing a hydraulic system in the nodal approach, the mass and energy conservation equation are easily formulated and unquestionable. The momentum equation however, is more doubtful because the friction factor and momentum flow terms are generally formulated on the basis of steady state conditions. The extension of the validity of this formulation to rapid oscillary transients is not well agreed upon. The proposed experiment will attempt to provide direct experimental data on the validity and short comings of the current assumptions by measurements in extremely simple and clear situations.

The experimental facility is a U shaped tube, separated by a quick opening valve in to two parts. The two parts of the U-tube each represent a part of a primary LWR circuit. They are partially filled with air-water or vapour-water and held at different pressure levels. Once connected by means of the quick opening valve, the oscillation behaviour of the two volumes is measured and recorded. The air-water experiments are foreseen to minimize the influence of two-phase flow disturbances and thermohydraulic non-equilibrium conditions, while the vapour-water experiments will simulate the real conditions occurring during reactor blowdown.

#### c) Two Phase Mass Flow through Convergent Nozzles

The objective of this experimental study is the calibration of convergent nozzles for two phase mass flow measurements. Such nozzles are required for the rupture simulation in blowdown experiments.

The experimental facility required consists of

- the test section, composed of a circular tube with convergent nozzles of variable cross sections at the upstream end ;
- a two-phase mixture supply system for pressure up to 100 bars and mixture qualities between 0 and 100 percent;
- instrumentation for measuring absolute and differential pressures, temperatures, two-phase flow momentum at the tube outlet and densities.

#### d) Development of a Mass Flow NMR Measurement

The objective of this study is the development of a two-phase mass flow measurement method and device applying NMR techniques. Such measurements are essential for the Ispra Blowdown Experiment. Existing measuring devices do not reveal the required performances and precision.

Nuclear magnetic resonance (NMR) is a powerful tool for studying the motions of nuclear possessing a magnetic moment. These motions can be either of a statistical molecular type (e.g. diffusion), or of a macroscopic flow type. Commercial apparatus does not meet the special conditions of mass flow measurements foreseen in a Blowdown experiment. A special apparatus must therefore be developed which meets these requirements.

It is intended to measure the free induction decay following a  $90^\circ$  pulse, or the echo envelope in a Carr-Purcell pulse sequence. This signal is proportional to the number of polarized protons in the NPR coil wound around a loop tube, in which water is flowing. The flow of these protons out of the coil is measured and from this their velocity distribution can be obtained. The mass distribution in a two phase system poses some problems and the theory for its extraction from the measured data must be developed in the course of the work.

The first step of the investigation will be a preliminary experiment giving values of the signal to noise ratio and of the transmitter power which can be extrapolated to the final conditions of the Blowdown experiment.

In the second step a magnetic resonance coil must be constructed which will withstand the final conditions in the LOGI. In parallel, the theory for the evaluation of the results must be developed.

The third step required the set-up of a power transmitter and of a combined polarizing and measuring magnet.

In the last part of the study a prototype apparatus, dimensioned for the LOGI will be set up, and test measurements will be carried out with it.

#### 2.1.2.4. Thermohydraulic fuel bundle behaviour during LOCA

For predicting the thermohydraulic behaviour of the core during LOCA it is necessary to apply computation models which rely on a correct description of the physical phenomena involved.

Up to now insufficient attention has been paid to lateral non-uniformities in heat generation and geometry which lead to a 3-dimensional situation with a potential harmful effect on heat transfer in core regions with the highest ratings. The effects to be considered are, among others : redistribution of axial mass flow, cross flow (two-phase) mixing between adjacent sub-channels, coupling of transient heat conduction in the fuel rod with coolant heat transfer. To improve our understanding in this area a combined theoretical and experimental research programme is undertaken.

The theoretical part of the research is a further development of the methods for which the basis has been laid in the present multiannual programme.

The experimental part involves boiling mixing studies in rod bundle test sections and is aimed at providing important data with regard to lateral thermohydraulic interactions between adjacent sub-channels. This work is carried out in the frame-work of contracts with CNEN (Italy) and BMFT (Germany).

a) Development and validation of computation models for transient fuel bundle behaviour during LOCA

- Development of computation methods for combined flow and heat transfer transients with coolant boiling in large rod bundles under conditions typical for LOCA. Emphasis is placed on the correct description of inter-channel cross flow and mixing phenomena caused by lateral non-uniformities in geometry and heat generation ;

b) Experimental studies on rod bundle heat transfer during LOCA

- a basic experimental study on interchannel mixing and cross flow in rod bundle test sections under boiling conditions typical for PWR and BWR ;

2.1.3. Planning

See table E. I. 01/d

2.1.4. Collaboration with external Organizations

BMFT - Bonn	GAAA - Paris
LRA - Garching	KWU - Erlangen, Grosswelzheim
IRS - Köln	GKSS - Hamburg
TU - Berlin	CNEN - Casaccia
CISE - Milano	CEGB - Marchwood Eng. Lab.

PLANNING

Action	1977	1978	1979	1980
2.1.2.1 Task 1	█			
Task 2	█	█		
Task 3	█	█	█	
Task 4	█	█	█	█
2.1.2.2 Blowdown code validation & development				
2.1.2.3 Basic experimental support to Blowdown				
2.1.2.3a Modif. test facilities	█			
Experiments				
Evaluation of results				
2.1.2.3b Construction test facility	█			
Experiments and evaluation				
2.1.2.3c Construction test facility	█			
Experiments and evaluation				
2.1.2.3d Development of power transmitter and theoretical calculus		█		
Setting up of prototype measuring apparatus and measurements		█		
2.1.2.4 Computation models for transients				
Mixing experiments				
Direct support to Blowdown				

## 2.2. IN PILE STUDIES

### 2.2.1. Background

A proposal to use ESSOR for major in-pile safety studies within the frame of the next multiannual safety programme of the JRC should be considered bearing in mind the fact that the whole ESSOR complex is currently exploited under article 6c) of the Euratom treaty and therefore the utilization of the reactor is the responsibility of the Italian Government. However this proposal is part of an in-pile programme of sufficient generality to embrace the "fuel behaviour" problem of all the varieties of water reactors currently considered in the Community and as such should be of interest to all Member States. Hence a suitable arrangement could be found between the Commission on the one hand and the Italian Government on the other for the provision of a channel in the experimental zone of the ESSOR Reactor in which can be installed the in-pile section of a Community funded accident simulation (COFAS) loop. The rent which the Community would have to pay the Italian Government for the use of this channel would have to cover both the cost of the neutrons and that of an appropriate part of the reactor operations and maintenance manpower.

Both the proposed COFAS loop and test-programme will necessarily have to fit well into the world context in the field of water reactor safety research at the time when the testing is executed. As will be seen later, the period when the COFAS test programme is likely to be carried out is after 1982 which means that the loop must be conceived so as to answer the major questions expected to arise at that time. According to some of the leading experts in the field, current programmes will give a good understanding of "single rod" fuel behaviour in accident conditions (mainly the LOCA) and that future work must examine the interaction and scaling effects which depend on the rod bundle size and the detailed hydraulics of rod bundles.

During a meeting organized by the United States NRC<sup>(1)</sup> in January 1976 in order to discuss future in-pile accident simulation work with their collaborating partners from Germany, Italy (with ESSOR-participation) and Japan, it was concluded that, after 1980, there should be available somewhere in the world, and open to multinational

---

(1) Nuclear Regulatory Commission

collaboration, a fuel rod bundle accident simulation facility of significantly greater size (length and number of pins) than the facilities currently in operation or being designed (PHEBUS, Cadarache; PBF, Idaho; FR2, Karlsruhe; SARA, Ispra). The meeting identified sixteen major items for continued or extended investigation during the 1980s. Since it would be impossible to consider all of these items in only one loop, it is felt that the ESSOR environment would favour a consideration of the following important sub-set taken from the 16 items, in which emphasis is to be placed on the LOCA:

- mechanical rod/rod interaction due to rod bowing, ballooning etc, with potential for failure propagation;
- interaction between coolant flow distribution in a rod bundle and rod geometry changes, with potential for failure propagation;
- bundle length scaling effects;
- behaviour of commercially enriched fuel, especially after irradiation (instead of the high enrichments often used in current programmes).

Other large bundle facilities around the world would have to specialize in the other items (e.g. interaction between rod ballooning and loop flow distribution).

An in-pile safety testing programme aimed at examining the above items will impose stringent operational requirements on the COFAS loop, but considerable progress has already been made in this area, by the studies of the proposed SARA loop, being carried out by the UKAEA-HARWELL under contract with the ESSOR Division (on behalf of the bodies responsible for the Italian in-pile safety testing programme). The detailed design and construction of SARA will be contracted out to a body well experienced in both loop engineering and in-pile research, and it is likely that COFAS will be realized in the same way.

Following the philosophy of the SARA loop, the aim of the COFAS loop will be to provide data on fuel bundle behaviour over a wide range of simulated accident conditions in which the confusion due to uncertainties in the thermo-hydraulic aspects of the accident is minimized.



The SARA loop is being designed to accommodate up to 16 fuel pins in a test section of re-entrant (U-flow path) design capable of operating at powers up to 650 KW. By suitable valve and reactor control manipulation programmes, the SARA loop will be able to create within this test section a very wide range of well defined thermohydraulic conditions which simulate the conditions expected to occur in any sort of accident up to a severe LOCA. The attainment of the required precision in the imposed thermohydraulic conditions will be ensured by carrying out exhaustive tests in a parallel, electrically heated, out-of-pile replica of the in-pile section. Conditions appropriate for PWR, BWR, CIRENE and SGHWR reactor types will be equally attainable. The loop is conceived so as to facilitate the clean-up of failed fuel and fission products.

In order to ensure a significant extension of the results expected from the SARA loop (in the frame of the Italian safety testing programme) and from other major known basic in-pile safety programmes (PHEBUS, Cadarache; PBF, ANC, Idaho; FR-2 Karlsruhe) it is proposed that the COFAS loop should be capable of accommodating large rod bundles of up to 2 m active length operable up to 3.3 MW. This requirement will demand only one significant change in the engineering of the COFAS loop in relation to the SARA loop: the in-pile test section of the COFAS loop will have to be of once-through design instead of re-entrant. Apart from the trivial consequence that the out-of-pile section (for the important task of verifying the calculated thermohydraulic performance) must also be of a once-through design, the remainder of the COFAS loop can be essentially the same as SARA (suitably enlarged for the higher power). Large rod bundles will be more representative of real fuel assemblies and, if Member States experts agree, the loop should be conceived for the examination of the effects enumerated above.

To provide a concrete basis for the early conceptual studies of the COFAS loop, proposed for the first phase during 1977, the following two reference fuel rod bundles are suggested:

a) PWR-type, 52 (8x8-12) rod bundle:

rod OD	9,5	mm
rod pitch (square)	12,6	mm
rod length	2	m
max. linear power	440	W/cm
axial peak/average power	1.4	
radial " " "	1.0	(by enrichment zoning)
total power	3.3	MW
system pressure	16	MN/m <sup>2</sup>

coolant mass-flow	18.4	kg/s
coolant mass-velocity	3340	kg/m <sup>2</sup> s (0.005 m <sup>2</sup> flow area)
coolant inlet temperature	300	°C
coolant outlet temperature	333	°C

Fuel enrichments to attain this performance not expected to exceed 4 %.

b) BWR-type, 37 (7x7-12) rod bundle

rod OD	12.27	mm
rod pitch (square)	16.16	mm
rod length	2	m
max. linear power	440	W/cm
axial peak/average power	1.4	
radial " " "	1.0	(by enrichment zoning)
total power	2.32	MW
system pressure	7.4	MN/m <sup>2</sup>
coolant mass-flow	10	kg/s
coolant mass-velocity	1470	kg/m <sup>2</sup> s (0.0068 m <sup>2</sup> flow area)
coolant inlet temperature	290	°C (saturation)
outlet steam quality	0.157	

Fuel enrichments needed to attain this performance not expected to exceed 2 %.

As stated above, the research programme set up on the basis of the COFAS loop must be sufficiently general to ensure a broad-based interest among the Member States. We feel that the best way to achieve such generality is to adopt the "code validation" approach. This means that the fuel behaviour patterns occurring under the accident situations of interest must be generated and studied primarily with the aim of validating and improving the relevant "fuel bundle response" codes used for safety analysis: the studies must be "generic" and seek to obtain results valid for all interesting reactor types.

The ESSOR Complex has several features which make a programme based on this philosophy of wide interest:

- the completely-contained loops in sealed pressure-proof bunkers allow examination of fuel failure and dispersion modes beyond the stage normally considered in most other experimental programmes;

- the large core length (1.5 m active, 2.2 m potentially useful flux) allows testing of longer experimental fuel rods than can be accommodated in similar reactor facilities and therefore gives a better representation of the relevant fuel rod processes;
- appropriate PIE (post irradiation examination) equipment exists and can be extended in the ESSOR Complex to meet the needs of the experimenters.

### 2.2.2. Description of the objectives of the COFAS programme

Taking account of the financial impact of this project and of the technical difficulties of its realization and its important place in the framework of the international activities in this field, it is not envisaged to take an immediate decision on the construction of the COFAS loop.

The proposed actions (chapter 2.2.3) have for their aim the preparation of a technical dossier which will allow a decision in 1979 in the framework of the programme revision of the JRC.

In contrast to the proposed actions given in Chapter 2.2.3, the experimental programme outlined below in this chapter is a general formulation which seems to be opportune at this time. The stated programme can be updated during the design phases of the loop (1977-1980). In particular it will be possible to take into account the results of other in-pile test programmes (PBF, PHEBUS, FR2).

The proposed Community programme outlined below will overlap and have many features in common with the Italian programme based on the SARA loop. The great advantage in pursuing these two overlapping programmes in the same reactor system is that there arises an opportunity to carry out certain closely related tests and thereby bring out more clearly the importance of such parameters as the number of pins and the length of the bundle.

One of the most important parameters to be investigated in the experiments described below is the burn-up level of the fuel. To this end test fuel bundles will have to be pre-irradiated by means of an arrangement with the operator of a suitable power reactor. For short pre-irradiations, the possible use of the large Italian sponsored loops in ESSOR can be considered.

#### 2.2.2.1. Preliminary Exercise: Exploratory "Fuel Failure" Capsule Experiment

In order to have a testbed for in-pile instrumentation and obtain a good preliminary idea of the fuel behaviour phenomena to be handled in the subsequent COFAS loop experiments, it is desirable to construct a specially strong capsule facility for the exposure of single fuel pins specimens to all the accident conditions of concern. This facility could be designed to go beyond the conditions permitted in the SARA and COFAS loops and allow the simulation of accidents rising in severity up to ECCS failure and gross fuel melting and relocation. In this way, the scope and limits of the instrumentation and the whole range of problems generated by the programme can be better foreseen.

This type of experiment could give, on a small scale, data on fission product release and on the characteristics of irradiated  $UO_2/H_2O$  interactions which will assist in the hazards analysis for the COFAS experiments.

#### 2.2.2.2. COFAS Loop Exercise 1: Fuel Behaviour in Power/Cooling Mismatch (PCM) Conditions

A variety of power/cooling mismatch tests can be investigated, extending progressively into the post dryout region and beyond. The main aim would be the determination of the thresholds, mechanisms, modes and consequences of fuel cladding failure. Tests could be done with various cluster sizes, irradiated or non-irradiated.

Parameters to be studied (where feasibility permits) are:

- fuel rod design, i.e. gas gap dimensions, cladding thickness, fuel pellet density, internal gas pressure, etc.;
- rod-to-rod interaction, effect of the number of rods;

- irradiation effects<sup>+</sup> on fuel rod response during a PCM incident;
- rate of approach to and withdrawal from CHF; duration of CHF conditions.

#### 2.2.2.3. COFAS Loop Exercise 2: Fuel Behaviour Following a Gross Inlet Blockage

The gross inlet blockage is considered by many authorities to be the "worst hypothetical accident" of certain BWRs. These tests would simulate such an accident by programmed flow decrease, representing blockage fractions progressively increasing in the range 95-100%. The power would be programmed to fall to values consistent with the void coefficients of interest (up to 50 % reductions). The fuel cluster would be instrumented and examined to determine the fuel rod thermal, mechanical chemical reaction and internal gas pressure response to these conditions.

Parameters to be studied (where feasibility permits) are:

- blockage fraction and type;
- power history;
- fuel rod and cluster design parameters;
- initial burnup.

An important cooling mechanism in a rod bundle with a serious gross inlet blockage is likely to be thermal radiation. Thus, the number of rods becomes an important parameter which makes it desirable to relate the tests to those carried out in the smaller SARA Loop.

x

For example, cladding irradiation damage state; internal gas pressure and composition; gap closure from creep collapse, fuel swelling/cracking, fuel cladding/bonding; fuel porosity due to densification and swelling; presence of corrosive fission products.

#### 2.2.2.4. COFAS Loop Exercice 3: Fuel Behaviour in Loss-of-Coolant Accident (LOCA) Conditions

By LOCA is meant the series of events initiated by a primary pipe rupture, followed by blowdown, refill, reflood and/or spray, and finally long-term cooling.

The approach to the overall LOCA will, of course, be gradual. The early experiments will embody programmed pressure/flow histories in the test section which yield only mild excursions in the cladding temperature. These experiments will be planned so as to gradually raise the peak and duration of the temperature history and, thus by small steps, gradually seek out the first signs of fuel elements damage. Thereafter, the experiments will extend the cladding temperature further into the "fuel failure" range. In this escalation procedure, the electrically heated out-of-pile section will provide invaluable guidance. The LOCA experimental programme will be broken into three logical phases.

##### a) Blowdown

Blowdown tests, following the above gradual procedure with respect to the cladding temperature, will be managed by suitable valve and reactor power manipulation programmes chosen on the basis of the known thermo-hydraulic characteristics of the COFAS loop (and checked in the out-of-pile section). The cladding and the fuel temperatures in the cluster will be instrumented as much as possible. The cluster can be examined at the end of each test and reinserted for further tests, provided gross damage has not occurred.

Parameters to be investigated (where feasibility permits) are:

- initial conditions;
- depressurisation rate;
- stagnation period and flow patterns;
- initial burn-up.

b) Refill, Reflood and/or Spray Cooling

Proceeding gradually, as described above (with respect to the cladding temperature), the post-blowdown, ECC phase of the LOCA will be simulated. Fuel rod clusters of nominal geometry (either unused or taken after blowdown tests) will be operated in the COFAS loop at low power (to simulate decay heat) and cooled by low pressure steam to attain the appropriate fuel rod temperatures. On reaching the desired conditions, the cluster will be subjected to the ECCS cooling process. The particular mode of ECCS simulated will be optional.

The clusters will be monitored and examined with a view to assessing cladding deformation, gas-gap conditions, fuel and cladding temperature histories, internal and external clad oxidation. It is hoped to acquire information on fuel failure modes and propagation.

Parameters to be investigated (where feasibility permits) are:

- heat-up rate (via power and steam flow);
- cooling rate (mass flow input);
- fuel rod and cluster design parameters;
- initial burn-up.

c) Complete LOCA Simulation

Fuel rod clusters will be subjected to a complete LOCA simulation, where the fuel rods will experience in a well controlled manner the appropriate time history of coolant pressure, fuel rod power, coolant flow and stagnation period and emergency cooling water flow rates. The experiments will be aimed at assessing the response of the fuel bundle (deformation and failure modes) in order to confirm the validity of the separate effects tests described above. Visual examination of the cluster will be possible between experiments. It is hoped to allow the transient to extend into an area where gross fuel failure will occur to assess the resultant cooling and reaction problems (chemical and thermal) and failure propagation mechanisms.

Parameters to be investigated (where feasibility permits) are:

- initial conditions;
- blowdown rate;
- flow stagnation period;

- cooling rate (ECCS water mass input rate);
- fuel rod cluster design parameters;
- initial burn-up.

#### 2.2.2.5. Analytical Support

The basic motivation of the above experimental programme, and the main reason to expect interest from Member States, is the fact that it is a generic programme aimed at the validation of "fuel bundle behaviour" computer codes and their interplay with "thermohydraulics" code modules.

Some of the intercoupled physical processes which must be treated are:

- evolution of the heat transport and mechanical properties of a fuel pin with the irradiation;
- time dependent heat conduction in a fuel element with varying properties (gas-gap, etc.);
- structural change of fuel elements during accidents (ballooning etc.);
- cladding rupture;
- mechanical rod/rod interactions with a potential for failure propagation;
- interactions between rod deformations and the bundle flow distribution with a potential for failure propagation;
- fission product release and subsequent distribution in the bundle and loop.

Current activity is confined to studies of the FRAP-T code of the Aerojet Nuclear Company.

While the fuel behaviour codes will be the main focus of theoretical activity, it has to be stressed that, in order to plan and interpret the experiments and utilize the loop in the best possible way, an extensive capability in the application and understanding of rod bundle and blowdown/ECC thermohydraulic codes will also be demanded. Current activity is confined to the preparation of a capability in the use of the RELAP-4 LOCA analysis code. It will be of the highest importance to assemble the necessary expert group, not only to participate in the detailed planning and interpretation of the experiments, but also



to serve as a channel for national code development teams who wish to check their particular codes against the in-pile experimental results.

### 2.2.3. Proposed actions for the 1977-1979 period:

The attached Table E-I-01/e shows a breakdown of the whole COFAS programme into its main phases. This schedule should be thought of in two stages: before 1980, when the essential ground work for the programme is done; after 1979, when a Council decision should be made, in the frame of a general programme revision, for or against the passage of COFAS into realization. The first stage is indicated on Table 01 by solid lines; the second by broken lines which represent a likely development schedule after 1979.

The essential basis for the COFAS programme would be laid down in three phases during the period 1977/79 (first 3 actions in Table E-I-01/e). The first phase would be the definition of the programme guidelines and a loop conceptual study in close cooperation with experts nominated by the ACMP-Safety. This would be of about 9 months duration and would require about 10 people and 0.5 MUA.

The second phase, of about 15 months duration, would be that of detailed loop design, leading to a realistic cost estimate. Phase 3 would be a 1 year study aimed at the specification of the COFAS loop experimental programme and operational procedures and the study of the loop licensing problems. Phase 2 and 3 would require about 20 people and 2.5 MUA. The people, and funds mentioned above would be employed mainly for study contracts.

The experience gained during the design phase of SARA will be available from the beginning of the conceptual study of COFAS. The experience of construction, licensing and commissioning of the SARA loop will be progressively available to the COFAS project during 1978/79.

With this plan of action, the ACMP-Safety would be able to give, towards the end of 1977, its advice on the passage to the detailed design, the Commission will be in a position to submit to the Council, in the general frame of the programme revision (1979), a firm and detailed proposal for the construction of the COFAS loop, its experimental programme and the possible associations with national partners.

With this aim, the General Director proposes to include in the multiannual programme 1977-80 the following actions:

- a) a conceptual study requiring 10 people for 9 months (1977) and a fund of 0.5 MUA for contracts;
- b) a detailed engineering design, including a cost estimate, requiring 20 people for 15 months (1977/78) and a fund of 2 MUA for contracts;
- c) a complementary study aimed at the specification of the loop experimental programme and operational procedures and the licensing problems, requiring 20 people for 1 year (1979) and a fund of 0.5 MUA.

The General Director will commit the funds for the conceptual studies (point (a) above) at the beginning of the programme. The funds for the detailed design (points (b) and (c)) will remain blocked by the General Director until the ACMP-Safety and the General Advisory Committee have given him a favourable advice on the results of the conceptual studies.

### 2.3. MANPOWER AND COSTS FOR PROJECT 2

PROGRAMME : REACTOR SAFETY				
PROJECT 2 : LIGHT WATER LOSS OF COOLANT ACCIDENT				
a) OUT OF PILE STUDIES				
	1977	1978	1979	1980
RESEARCH STAFF	62	62	62	62
INVESTMENTS (K.U.A.)	←----- 1350 -----→			
RUNNING COSTS (K.U.A.)	530	530	530	530
CONTRACTS (K.U.A.)	←----- 530 -----→			
RESOURCES (K.U.A.)				
EXPECTED INCOME (K.U.A.)	←----- 700 -----→			

PROGRAMME : REACTOR SAFETY				
PROJECT 2 : LIGHT WATER LOSS OF COOLANT ACCIDENT				
b) IN PILE STUDIES				
	1977	1978	1979	1980
RESEARCH STAFF	10	10 + 10 <sup>+</sup>	10 + 10 <sup>+</sup>	10
INVESTMENTS (K.U.A.)				p.m.
RUNNING COSTS (K.U.A.)	100	200	100	p.m.
CONTRACTS (K.U.A.)	400	1.800	400	p.m.

x To be transferred from other tasks of the Reactor Safety Programme

TABLE E-I-01/e: Community Funded Accident Simulation (COFAS) Loop: Rough Schedule

	1977	78	79	80	81	82	83	84
- Definition of COFAS programme guidelines and loops conceptual studies with ACPM-Safety experts		ACMP advice						
- COFAS loop detailed design; cost estim.			Council prog. revision					
- Specification of experimental prog. and loop operational procedures; study of loop licensing problems								
- Theory and codes; pre-calculation and analysis of experiments								
- Hot labs., preparation and post-test examinations								
--COFAS loop final design construction and commissioning								
- Detailed specification of test programme								
- Design and construction of COFAS test fuel bundle								
- Execution of COFAS test programme								
- Execution of SARA test programme (for reference)								

### 3. PROJECT : LIQUID METAL FAST BREEDER SUBASSEMBLY THERMOHYDRAULICS

#### 3.1. BACKGROUND

In considering L.M.F.B.R. safety, traditionally, emphasis has been given to core disruptive accidents. Assumed initiating events for the above may be : (a) Fault conditions in a subassembly (e.g. blockage or structural deformation), (b) Global accidents (e.g. loss-of-flow without scram or transient overpower without scram).

For the type (a) the likely sequence of events is :

(1) Local and undetected subassembly anomaly, (2) local undetected boiling entailing a local loss of cooling, (3) severe local pin damage leading to a propagation of the anomaly, (4) widespread boiling accompanied by subassembly voiding, (5) subassembly melt down, (6) subassembly-to subassembly propagation, (7) core disruptive accident. For the type (b) initiating event the accident chain is similar from event (4) onwards.

For analyzing the course of events 1-4 it is of prime importance to have a good understanding of subassembly thermohydraulics for both single and two-phase flow conditions.

Safety research aimed at providing an understanding of the most phenomena covers among others the following topics :

- Single phase fuel rod bundle temperature fields under accidental conditions
- Early failure detection based on temperature noise
- Basic sodium boiling phenomena
- Characteristics of sodium boiling in rod bundle geometrics.

The current status of knowledge regarding the above topics is summarized below.

#### 3.1.1. Single phase fuel rod bundle temperature fields

In the study of geometrical anomalies emphasis has been hitherto on "planar blockages". Most blockage experiments have been done using water as circulating fluid (Karlsruhe). They give a fairly good idea of "downstream region" temperature increments to be expected and show that local sodium boiling is not likely to occur when blocked areas are less than 65% and 10% of the total flow area for central blockages and corner blockages respectively.

Theoretical work on blockages based on an empirical lumped parameter approach has proved to be useful. The effort aimed at providing detailed thermohydraulic predictions was focused on the SABRE code (U. K.).

This code is based on the application of a numerical differencing scheme which unfortunately leads to large errors (numerical diffusion). One may therefore expect that during the coming years a very substantial effort will remain necessary for developing SABRE-type computation methods.

So far only very limited research has been carried out for code validation by "clean" hydrodynamic experiments (velocity field and turbulent flow properties in the weak region). Such experiments have been initiated now at Ispra.

### 3.1.2. Temperature noise

There is substantial evidence that the phenomenon of temperature noise in the plenum beyond the fuel bundle outlet is primarily a consequence of (a) a non-uniform time average coolant temperature at the fuel bundle outlet (b) turbulence prevailing in the bundle outlet plenum.

Experimental data have been obtained in bundles using both water and liquid as circulating fluid (Berkeley, Risley, Karlsruhe, Ispra). Present emphasis is on model - development and - validation. The model developed at Ispra (relating fluctuating temperatures to the axial decay of time-average fluid temperature by turbulent diffusion and turbulent length scales characteristics for the flow situation of the plenum) appears to provide satisfactory agreement with the experiments results presently available. To assess quantitatively the potential of temperature noise for early fault detection in L. M. F. B. R., research is still necessary to determine the influence of specific sub-assembly geometries and bundle outlet configurations and to develop the most suitable instrumentation for reactor application.

### 3.1.3. Basic sodium boiling phenomena

A phenomenon of key importance to reactor safety is the incipient boiling superheat, because of its effect on the process of coolant voiding in loss-of cooling situations. Other factors-parameters affecting the course of this process are boiling flow patterns, 2-phase pressure drop and thickness of residual sodium films at the cladding surface. For a basic study of the above, use has been made of simple geometries (tubes, annuli). The great amount of data accumulated on superheat at Ispra and elsewhere since the Aix-en-Provence Conference (1967) has not yet provided a full understanding of superheat. The evidence presently available shows that impurities (gas bubbles oxides nitrides) decrease the superheat. Characteristic of this phenomenon is the large scatter in the data (superheats varying between 0 and 100°C). The best method for assessing the superheat problem may be to carry out experiments in a by pass of the coolant circuit of an operating fast reactor.

The evidence on boiling flow patterns and 2-phase pressure drop is not yet entirely conclusive.

The situation depends on whether we have to deal with transient boiling or with steady boiling. The majority of data for steady boiling indicate an annular flow regime, but evidence has been also obtained that a slug flow regime prevails (Ispra). As to 2-phase pressure drop, part of the data obtained are in good agreement with Lochart-Martinelli predictions whereas other data deviate by more than 100 percent. The above shows that continued research in this area is necessary.

#### 3.1.4. Sodium boiling in rod bundles

The aim of sodium boiling in rod bundles is two fold :

- a) to study thermohydraulics during flow- and power-transients
- b) to study steady boiling in bundles with geometrical anomalies such as may arise in reactors.

In recent years data have been obtained on both steady- and flow- transient boiling in 7-rod bundles (Argonne, Grenoble, Japan, Karlsruhe) and in a 19-rod bundle (Grenoble). The steady sodium boiling experiments have shown that boiling primarily or exclusively occurs in the downstream unheated part of the rod bundle, installed there to simulate the upper blanket. The suppression of boiling in the heated zone is due to the important 2-phase pressure drop associated with flash boiling in the exit part of the test channel. The above stabilizing effect of the blanket is of considerable importance to the safety argument.

Two-phase pressure drops measured in the bundle experiments are in relatively good agreement with Lockhart-Martinelli predictions.

The sodium boiling behaviour observed in the 7-rod bundle during pump run down strongly depends on the value of incipient boiling superheat which in most runs is zero but occasionally assumes values of up to 70° C (Karlsruhe). In line with expectations at high superheat the boiling process initiates over a larger axial region leading to rapid flow reversal.

Recent theoretical work has shown the very important effect that the heat capacities of fuel (heater) rods and structural materials have on (a) the transient coolant temperature field prior to the onset of boiling and (b) the characteristics of the boiling process (Argonne, Ispra). In this connection it is worth mentioning that the data of the 7-rod bundle transients (Karlsruhe) were to a very large extent affected by the thermal inertia of the wrapper wall.

A large number of experimental data are already available with regard to sodium boiling in bundles with radially uniform heating (Japan, Argonne, Grenoble, Karlsruhe). Still lacking are data in relatively large bundles with a lateral variation of heat generation. The current 19-rod bundle tests (Grenoble) are to provide the first information.

Hitherto no data are available regarding the local boiling behaviour in bundles with geometrical anomalies. Local boiling observed in a wired 19-rod bundle of Grenoble was not deliberately provoked and its cause has not yet been ascertained. Codes describing transient boiling in large bundles with non uniform heat generation and steady boiling in bundles with geometrical anomalies do not yet exist and still require considerable development work.

### 3.2. TECHNICAL DESCRIPTION

#### 3.2.1. Code development and validation for rod bundle thermohydraulics

##### 3.2.1.1. Fault conditions due to geometrical anomalies

A chief objective is to complete the development of computation methods for the steady state thermohydraulic behaviour of a fuel rod bundle with specified faults under conditions of single phase flow. The reliability of these methods should be similar to that of our presently available methods for nominal geometries (HERA). The accompanying experimental work deals with measurements of velocity and temperature fields in bundles with flow restrictions. This requires the construction of an additional bundle test section.

Theoretical work - similar to the previous one - will be applied to systems with boiling two - phase flow. In experimental work a situation will be simulated characterized by a sudden release of fission gas in a failure region (e.g. downstream of a blockage).

The combined theoretical and experimental research on temperature fields in the outlet plenum of fast reactor sub-assemblies will be continued. The details of this programme depend on the results becoming available in the period from now until the end of 1976.

##### 3.2.1.2. Thermal fuel sub-assembly transients

Emphasis is here on the development of computation methods for combined flow- and heat transfer - transients with coolant boiling in single fuel channels.

Parallel to the above work, computation methods will be developed for accidental transients with coolant boiling in large fuel rod bundles.



### 3.2.2. Early warning techniques based on temperature noise analysis

#### 3.2.2.1. Fuel element failure detection and identification

The present studies, oriented more to the fundamental understanding of the temperature noise generation and its relation to a subassembly fault, will continue with water experiments.

The further tests should optimize the method as well as investigate the influence of specific subassembly geometries and outlet configurations (grids, wire-spacers, mixers, etc.). Parallel experiments with sodium have to start in order to investigate specific aspects of an application of the surveillance method under more realistic conditions. These sodium tests are mainly overall-tests for the method, but it would be of interest to include boiling initiation tests in order to verify that the early warning instrumentation can in addition also identify this extreme failure stage.

#### 3.2.2.2. Boiling detection for in-pile blocked fuel element experiment

This problem differs basically from the previous one : in contrast to the temperature noise source considered under 3.2.2.1., the local boiling generates temperature fluctuations in the subchannel flow inside the bundle. In order to identify the boiling onset from the overall temperature fluctuation signal, the characteristic properties of the boiling noise must be determined.

In a first step water experiments are foreseen in simple test sections with subcooled boiling in order to investigate the characteristic temperature fluctuations and to develop the analysis method. Consequently measurements in sodium test sections have to verify the applicability of the method and to identify the main noise parameters due to local boiling in sodium.

#### 3.2.2.3. Noise detector development

The development of a reliable temperature fluctuation instrumentation for reactor applications should be included in the studies.

#### 3.2.2.4. Experimental devices

Different test sections, especially the 169 heated rod bundle, are available for water experiments.

However some modifications must be foreseen for the variations of subassembly parameters and for the subcooled boiling simulation. The main analysis equipment is also available and only a few peripherals should be added. A suitable sodium test section should be constructed outside the J. R. C.

### 3.2.3. Studies on the dynamics and basic characteristics of sodium boiling in subassembly configurations

#### 3.2.3.1. Experimental and theoretical investigation on the influence of uniform and non-uniform heat flux distribution on the boiling behaviour in a simple geometry

The majority of sodium boiling studies have been designed to represent the thermal-hydraulic conditions of a single sub-channel of a fuel sub-assembly. The full representation of the boiling conditions of a sub-channel by this experiment suffers, even at present particularly from the non-reactor-like axial power distribution. Compared with boiling at constant heat flux conditions the non constant axial heat flux gives rise to the following differences :

- the location of boiling inception is shifting;
- because of the non-linear temperature gradient along the test section more coolant in the channel is overheated and the voiding process might be more violent;
- dry out might occur at lower heat fluxes.

The main objectives are therefore to perform experiments in single channel geometry (e. g. annulus) at uniform and non-uniform axial heat flux distributions in order to make a comparison with codes of transient and steady state boiling.

Furthermore, the existing rig offers, because of its hydraulic feature, the opportunity to study gas behaviour in loop systems, its detection and the opportunity to investigate its influence on the boiling behaviour.

A further objective might be the measurement of the bowing of the heater element during heating transient prior to boiling using X-ray and acoustic instrumentation. Even if these data do not reproduce realistic conditions, they could be evaluated statistically and deliver, for the present reference data for the instrumentation of the bundle experiment.

#### 3.2.3.2. Behaviour of porous blockages in fast breeder sub-assemblies

Local cooling channel blockages inside fuel assemblies are of utmost importance as initial disturbances for the failure propagation. They may originate from sedimentation of fuel particles or because of impurities in the primary circuit.

It is assumed that such blockages are porous and that therefore they have a residual mass flow. If these blockages reach a certain extent, the boiling in the blockage will occur. It is uncertain whether a cooling of the blockages is still possible after the beginning of the boiling, or whether a local melting of the fuel takes place, due to sodium voiding and dry-out. Local melting of fuel and cladding material may- by building larger blockages - lead to a further and quicker propagation of pin failure.

The aim of these studies is therefore to find out whether local porous blockages are still being cooled during the boiling process without a dry-out.

Important parameters are the radial and axial extent of the blockage, the porosity, the heat flux and the hydraulic data. It is proposed to start the experiments with a simple geometry in order to acquire a basic knowledge of the importance of the various factors.

### 3.2.3.3. Cluster boiling experiments in small bundle geometry

As far as small bundle experiments are concerned, successful tests have already been performed in several laboratories (CEN-Grenoble, GFK-Karlsruhe, RCN-Petten, ANL-Argonne) in 7-pin test sections.

The common feature of all these tests was the uniform mass flow rate in all subchannels and uniform power of the heating pins. In the future, an investigation programme is proposed which could be complementary to the ones executed.

Compared with a simple configuration, the sub-assembly has the following obvious differences :

- inter-connected sub-channels,
- complex flow passage shape,
- sub-cooled edge sub-channels near the wrapper.

The main objectives of the experiments are therefore to make comparisons with single channel studies and to acquire a lead on the potential for extrapolating data from small to larger clusters and to modify the boiling codes to cluster application. Comparisons with single channel experiments would be based on measurements of pressure drop, boiling pattern development, void distribution and dry-out.

Although it is not a main feature of the experiment, it is considered that assessments of liquid superheat, if it occurs, should be made. This is a good opportunity for establishing in a realistic geometry, whether local temperature features preclude significant bulk superheat. With a rig that normally is favourable to producing liquid superheat, and that also includes gas measuring equipment, it is possible that definitive data may be obtained.

A further subject would be, if considered important, the measurement of the bowing behaviour of the heater elements during heating transients prior to boiling.

### 3.3. PLANNING

See table E. I. 01/f

### 3.4. MANPOWER AND COSTS

PROGRAMME : REACTOR SAFETY				
PROJECT 3 : LIQUID METAL FAST BREEDER SUBASSEMBLY THERMOHYDRAULICS				
	1977	1978	1979	1980
RESEARCH STAFF	30	30	30	30
INVESTMENTS (K.U.A.)	←----- 570 ----->			
RUNNING COSTS (K.U.A.)	230	230	230	240
CONTRACTS (K.U.A.)	←----- 200 ----->			

### 3.5. COLLABORATION WITH EXTERNAL ORGANIZATIONS

GfK - Karlsruhe  
 CNEN - Casaccia, Bologna  
 Belgonucléaire - Brussels  
 UKAEA - Risley  
 CEA - Grenoble  
 Université de Louvain  
 Université de Torino  
 RCN - Petten  
 CEN - Mol  
 CEGB - Berkeley

**PLANNING**

**Action**

	1977	1978	1979	1980
3.2.1	Benchmark experiments on bundle fault conditions 3D transient code Support to bundle boiling			
3.2.2				
3.2.3				
			Continuation depends on results of basic studies	

#### 4. PROJECT : FUEL COOLANT INTERACTIONS AND CORE MELT DOWN

##### 4.1. BACKGROUND

Considerable theoretical and experimental effort has been devoted in many countries to the solution of the fuel coolant interaction (FCI) problems in the past years. The USAEC, UKAEA, CNEN, GfK, CEA, Power Reactor Corp. of Japan, as well as many other public and private organizations have presented their results on this particular subject during specialist meetings which were sponsored by the OECD-NEA. Ispra started these studies with a small effort before the pluriannual programme and produced a number of results during the period 1972-76. The collaboration with some of the member countries was particularly close and well co-ordinated. The theoretical and experimental work was much more difficult than initially expected and it seems that reactor designers and licensing authorities are not yet in a position to make realistic predictions of the consequences of an accident during which FCI occurs. A number of so-called parametric codes exist from which it is possible to have an estimate of the consequences of an FCI, but there is some experimental evidence that these evaluations tend to considerably overestimate the pressures and conversions of thermal energy into mechanical energy.

Questions arise as to whether the experiments correctly reproduce the reactor conditions (i. e. masses of material involved, mode of contact, geometries) and what type of new experiments could be designed which could better reproduce the postulated boundary conditions in the codes.

There are scientists who from a theoretical analysis have come to the conclusion that more violent explosions than those already known could be produced by triggering the interaction with a pressure wave. Others have indicated that there could be thermal parameters, i. e. contact temperature, which could define regions of mild and violent interaction.

One may conclude that at the moment a large gap exists between experimental in- and out-of-pile results and the theoretical understanding of the phenomena.

Less effort has been devoted to the problem area of core melt down and post accident heat removal.

At the present time one finds in the literature practically no data on fundamental properties of the melts (such as solidification enthalpy and temperature radiation emissivity thermal conductivity, viscosity, phase diagrams and so on) or on their compatibility with structural materials. This holds especially for the large variety of mixtures which can result from the core components, coolant, core-catcher (with possible sacrificial layers). The reasons for this lack of data are the difficulties which occur when such properties have to be measured at very high temperatures.

The fission product release from molten fuel under different environmental conditions must also be investigated.

Once the basic melt properties are known, questions have to be solved concerning the mechanical layout of the catcher and the heat removal system.

In fact the core catcher structures will be submitted to thermal and mechanical loads before and during the core melts.

The heat transfer models in different core melt configurations are also unknown and will be investigated with simulated core-melts.

Furthermore, integral tests should be performed in order to assess the possibility of attaining a thermally and structurally stable core-melt/core-catcher system and to validate the codes which describe such a system.

## 4. 2. TECHNICAL DESCRIPTION

### 4. 2. 1. Fuel coolant interaction

The present programme proposal is designed to answer open questions by putting an appropriate effort into the development of a theoretical model and calculation code which would eliminate a large number of arbitrarily chosen parameters in the available calculation tools. First steps in this direction have been taken in the past by developing an FCI model which includes the calculation of fuel fragmentation and bulk coolant movement in a channel geometry. The continuation of this work includes the study of different fragmentation phenomena such as coolant impact, thermal stresses and the detailed analysis of the heat transfer process. This model will then have to be included as a source term in a two-D compressible hydrodynamic code in order to study confinement effects.

The experimental programme will be closely linked to the theoretical investigations and will have to answer specific questions rather than try to investigate global effects in a phenomenological way. The most flexible pieces of equipment already existing are the water and sodium channel facilities.

This set-up has some similarity to the intact core geometry and allows an easy measurement of important parameters (pressure in the interaction region, coolant movement and vapour volume, temperatures, time dependant mechanical work).

The experiments in the existing water and sodium tank facilities are less flexible and give less direct results but they reproduce conditions where parts of the core fall into a pool of coolant. These installations are used for the study of confinement effects and will allow the performance of coolant entrapment experiments. The use of these installations is foreseen only for a part of the programme period.

Most of the required experimental conditions can be reproduced with the existing installations. However data is lacking concerning the forced injection of molten fuel material into a wrapper filled with coolant. Initial fixed parameters in such an experiment are the gas content, temperatures and pressures in melt and coolant whereas the velocity and/or the quantity of interacting materials may change with time.

An important experimental and theoretical effort has to be made in order to analyse the above mentioned conditions. For the experimental part a feasibility study is necessary for design and construction of the injection device.

Preliminary laboratory scoping experiments are foreseen in order to enable a preliminary choice of parameters to be studied on all existing and new plants.

#### 4. 2. 2. Core melts post accident heat removal

The goal of the basic part of this programme is to identify the materials which are best suited for the core-catcher and for the sacrificial layers and to find (by theoretical studies) the most suitable arrangement for the removal (or storage) of decay heat after a hypothetical core disruptive accident.

A basic need for this work will be an indication, given by the national safety analysis groups, of the type of molten core composition to be expected for the accidents of concern, and of the physical properties required to adequately describe molten core behaviour.

##### 4. 2. 2. 1. Basic studies

###### a) Material Properties

Depending on an assessment of the relative importance of the various fundamental properties of core melts a programme of measurement of these properties will be carried out as a logical extension of the current work on viscosity surface tension and compatibility with structural materials. Theoretical interpretation and correlation of the experimental results will be made in view of their use in theoretical models and core catcher codes.

In addition studies of the combinations of core-melt materials occurring during the various phases of a melt-down accident are expected to take an important place in the basic programme.

###### b) Behaviour of irradiated fuel rods during melt down

The purpose of the proposed investigation is to specify with experimental data obtained with irradiated material the physical and chemical phenomena occurring during the melt down phase of fuel rods. These studies should be complementary to those already underway in other laboratories with non-irradiated material or with fuel containing simulated fission products.



The work will be carried out in the LMA utilising the existing facilities and samples taken from fuel rods of different degrees of burn-up already collected from various European Nuclear Power Stations.

The following studies are foreseen :

- Physical and chemical behaviour of a fraction of a fuel rod as a function of temperature in the range from the normal operation temperature up to the melting temperature of  $UO_2$ . This behaviour has to be studied for samples of different burn-up. Optical and electron-micro-examining analyses will be used for the investigation of the metallurgical phenomena. The remaining fission products will be measured by gamma-spectrometry.
- Determination of mechanical properties of the cladding for different burn-up. Burst tests will be performed on parts of fuel rods under different temperature and environmental conditions.

The activities "Material properties" and "Behaviour of irradiated fuel rods during melt-down" will be partly carried out at the Karlsruhe Establishment of the JRC. In fact this Establishment is specialized in investigations of fast reactor fuels. In the field of LMFBR a clear definition of the problems and their priorities is still necessary. This will be the task for the first year of this programme; and the global effort on the LMFBR fuel will increase during the following years.

The activity of LWR core-melts will be essentially carried out at Ispra where a certain number of studies are already underway.

### c) Heat Transfer Studies

Many core material configurations are possible with different densities of the melt and physical states (pebble bed, molten, pool, molten volume in a solidified crust etc.) and it is proposed to systematically investigate the heat transfer modes occurring in these configurations to check and develop various available heat-removal codes.

Code validation experiments will be performed with simulated materials.

The simulated pool will be heated externally or by internal heat sources.

The natural convection flows and heat exchange modes will be studied in both cases.

#### d) Thermomechanical Behaviour of Core-melt Barriers

Depending on the design of core catcher systems which should be better defined during the coming years, investigations aimed at the mechanical behaviour of a core catcher are proposed.

Topics are : study of the thermal shock, of impact loading (core fall) and explosive loading (whole core accident in a fast reactor, depressurization in a water reactor).

The theoretical analysis of the results of this part of the study will be done in close collaboration with the analytical groups of Chapters V and IV.1.

#### 4.2.2.2. Integral Tests

Difficulties have been encountered in the past when handling small quantities of molten core material at extremely high temperatures.

Most of the basic studies discussed in the previous chapters will be performed with unirradiated materials and perhaps with simulated materials. It is expected that these studies, although absolutely necessary, will not give a final answer to the reactor designers and licensing authorities and it might be necessary to perform an integral test with realistic quantities of irradiated material and realistic geometries. Therefore, a feasibility study of an experiment in which a mass of core melt is assembled on a simulated core-catcher system will be carried out.

The simulated core catcher features would be specified in close collaboration with design and safety assessment groups.

The main parameters are the scale, the cooling modes and the various material options (e.g. sacrificial layers).

The test should make use of irradiated reactor fuel elements in order to ensure the correct decay heat source and to investigate the fission product release and their effect on such processes as fuel/coolant interaction.

If a test with irradiated fuel does not appear to be feasible, the study could be foreseen with non-irradiated fuel molten down by electrical power.

#### 4.3. PLANNING

See table E-I-01/g.

#### 4.4. MANPOWER AND COSTS

PROGRAMME : REACTOR SAFETY				
PROJECT 4 : FUEL-COOLANT INTERACTIONS AND CORE MELT DOWN				
	1977	1978	1979	1980
RESEARCH STAFF	40	40	40	40
INVESTMENTS (K.U.A.)	←----- 850 ----->			
RUNNING COSTS (K.U.A.)	370	380	380	380
CONTRACTS (K.U.A.)	←----- 390 ----->			

#### 4.5. COLLABORATION WITH EXTERNAL BODIES

BMFT - Bonn  
 TU - Stuttgart  
 GfK - Karlsruhe  
 UKAEA - Risley  
 CNEN - Bologna

TABLE E-I-01/g - PLANNING

<u>REACTOR SAFETY</u>				
Project IV : Fuel Coolant Interactions and Core Melt Down				
	1977	1978	1979	1980
<b>PLANNING</b>				
Action				
1. Fuel-Coolant Interaction Code Development and Validation Channel Sodium and Water Testing	← ←	← ←	← ←	← ←
Injection Facility				
- Design and Construction - Experiments	←	←	←	←
Laboratory Experiments	←	←	←	←
2. Core Melts; Post Accident Heat Removal	←	←	←	←

## 5. PROJECT : DYNAMIC STRUCTURE LOADING AND RESPONSE

### 5.1. BACKGROUND

The risk assessment of nuclear power generating systems calls for a study of the consequences of flow coast down and power excursions in an LMFBR. The loss of coolant accident connected with a fast depressurisation of the primary circuit is considered to be the worst accident in a light water reactor and has also to be investigated. The secondary containments of both reactor types may be subjected to impact loading produced by an aircraft crash, by missiles, or by the explosion of gas mixtures and their resistance has to be guaranteed. The proposed programme is expected to contribute to developing and validating codes which are capable of answering those questions in the above accidents which concern structure loading and response.

The presented activities are a major object of applied research in all those countries which are involved in construction and licensing of water and sodium cooled reactors.

These studies were started by performing experiments on models, but it soon became apparent that empirical results could not easily be extrapolated to real reactor situations. Therefore the need to develop and validate codes has not become the primary goal in all research institutes.

Concerning the LMFBR containment studies, the U. K. A. E. A. has provided the ASTARTE programme which most of the EEC countries have access to through the work performed in the J. R. C. . At Foulness and Winfrith experiments are performed using the same hardware as in Ispra.

Aldermason and Ispra are both working on 2-D finite difference Lagrangian and Eulerian codes and the work was organized so that the two studies are complementary. In the DeBeNeLux consortium, Belgonucleaire has been charged with the containment work. The Surboum code was developed and experiments were performed at Ispra. Interatom participated in these studies developing the 2-D Lagrangian code "ARES", the Eulerian code "DRAP" and starting the development of a 2-D mixed Eulerian-Lagrangian co-ordinates code called "KOLSCH".

Work is in progress at Karlsruhe with the 2-D "YACQUI"-code developed by Los Alamos.

France has in, this field, an experimental programme and it is known that work started on a new multipurpose 2-D code. Competence is available in finite element analysis of structures.

Italy has some activities concerning the PEC reactor at CNEN-Bologna. Experimental and theoretical work is done in close collaboration with Ispra.

ANL, SRI and Los Alamos played an important role in the past in this research. The most complete 2-D calculation codes (Rexco, Rexcat, ICECO, etc. . .) have been developed there. The most expensive experiments were performed at SRI although their value for code validation is very limited.

We are not familiar with the details of Japanese work in this field. Finite difference Lagrangian and Eulerian codes have been developed but their capabilities are unknown. Experimental projects related work was performed for the (MONJU) fast test facility. The 2-D Lagrangian compress-

sible code CEFRA has been carried out by Power Research Institute of Zechoslovakia.

The study of core internals is becoming an important field of investigation at the present. Ispra prepared this work, developing the dynamic elasto plastic finite element codes EURDYN1, 2 and 3 and performing experiments under contract with CNEN.

The U. K. A. E. A. has made large experimental efforts performing 1 : 1 scale experiments for SNR and CFR. Theoretical analysis of results will probably be based on the Ispra Eurdyn codes and Nonsap. Karlsruhe started a basic experimental and theoretical programme some years ago, which is expected to be linked with the Ispra activities. France is not involved in these studies. Proposals will presently be made to perform a common programme in this field in the laboratories of the European Communities in a well co-ordinated manner.

The U. S. research work is the most advanced in the field. New numerical techniques have been developed in the last few years and are now employed in codes such as Straw, Sadcat, etc.

No work has been published by Japan.

Dynamic mechanical properties of materials are necessary for the analysis of structures. Moreover, wave propagation in materials having constant or varying characteristics have to be investigated in order to establish the velocity of the wave and the wave profile during propagation. Ispra has performed an important programme in collaboration with all those laboratories in Europe which are involved in dynamic structure analysis (CNEN, UKAEA, KFK, CEA, Belgonucleaire) since 1966. To our knowledge only a few University institutes are also working in the field. We can especially mention the University of Oxford (U. K. ), the Center for dynamic plasticity (U. S. -Florida), South West Research Institute (U. S. ), Hanford Engineering Development Laboratory. Highly qualified work has been published by the Polish Academy of Sciences concerning constitutive equations of materials and experiments on wave propagation. Theoretical work on constitutive equations of materials and plastic wave propagation is performed at the University of Bucarest.

The Ispra activities should not be linked to any particular reactor design or project. They are intended to provide validated computer codes and well established constitutive equations for the reactor designer and for licensing authorities. It became evident in the current activities that considerable advantages can be achieved for code development and validation when a purposely designed theoretical and experimental programme is performed. The process of code validation consists both in confirming the validity of theoretical models used in the codes to describe the various physical processes and in checking the applicability of the numerical techniques used in the codes.

## 5. 2. TECHNICAL DESCRIPTION

For a better understanding of the proposed work, activities are summarized under two main headings. The first one describes the different problem areas for which codes have to be developed and validated. In the second one the research proposed in the field of constitutive relations is outlined.

### 5.2.1. Code development and validation

5.2.1.1. Part of the programme is a continuation for our present activity in the field of containment loading and response for LMFBRs.

Further development and validation of existing finite difference codes is needed in the fields of dynamic flow through holes, sliding of coolant on reactor internals, coolant impact on the roof etc.

Table III indicates a series of geometries with gradually increasing complexity which are at the same time experimental and theoretical tests.

5.2.1.2. The programme will be extended to study the behaviour under dynamic load of core internals, of stress concentration points in the vessel and other primary circuit components.

The 2-D and 3-D Eurdyn codes will be improved by providing a hydrodynamic part which calculates the time dependent loading acting on the structure. A complete solution of fluid flow equation in term of finite elements will be studied. Code validation tests will be performed in rigid and flexible structures. The following test programme is planned :

- Deflexion of single, internally loaded hexagonal tubes,
- Cluster tests
- Analysis of energy absorption in the breeder zone of an LMFBR during a WCA.

5.2.1.3. For piping studies a new code will have to be developed which should be capable of calculating wave propagation and fluid flow in straight pipes, in cross section discontinuities and in elbown. A 2-D calculation will be able to evaluate the plastic deformation of straight pipe walls, a 3-D analysis should be able to calculate also the smearing of the pressure peak in elbows. Experiments will be performed in which these geometries are reproduced and pressure and strains are measured.

5.2.1.4. 3-D problems have been mentioned for core internals study and pressure wave propagation in piping systems. Off-centre explosions, and off-centre structures are further cases in which 3-D effects are crucial. For a part of these studies 3-D structural codes already available will solve the problem whereas for others the development of a 3-D hydrodynamic and structural code will be necessary.

It is suggested to provide a sufficient effort in order to make a first assessment of calculation techniques to be used and computer facilities needed.

### 5.2.2. Determination of material constitutive laws

The above mentioned development and validation of 2-D and 3-D codes will only be possible if the properties of all components (constitutive laws) are available.

It is therefore within the scope of this research action to determine these relations in small scale clean reproducible experiments on specimens and semi-finished structures.

The activity is a continuation and an extension of work carried out in the 1973 - 1977 JRC programme and includes :

- influence of temperature and radiation level on the constitutive relations of various steels by means of mono-axial Hopkinson's bar type devices for the range of strain rates  $100 - 1000 \text{ sec}^{-1}$  and by means of pneumatic devices in the strain-rate range of  $0-100 \text{ sec}^{-1}$ .
- extension versus 2 axial states or stress and deformation rates, and extension towards higher strain rates ( $1000 \text{ sec}^{-1}$ ) in a shock tube,
- elasto-plastic wave propagation experiments in simple structures (long strips) and in semi-finished products using a high pressure gas shock tube to define the dynamic constitutive relations in a phenomenological way,
- study of equations of state (p, v, e relationships) for liquids submitted to tension waves. The problem arises when pressure waves in liquids are reflected at free boundaries (regions with low acoustic impedance compared to that in the fluid) and formation and collapse of vapour and gas bubbles may change considerably the equation of state,
- study of equations of state of a package of rods surrounded by a liquid which simulates the fuel rods in a subassembly or the neutron shields in a containment test.

### 5.3. PLANNING

See table E-I-01/h

### 5.4. MANPOWER AND COSTS

PROGRAMME : REACTOR SAFETY				
PROJECT 5 : DYNAMIC STRUCTURE LOADING AND RESPONSE				
	1977	1978	1979	1980
RESEARCH STAFF	32	32	32	32
INVESTMENTS (K.U.A.)	←-----	500	-----	→-----
RUNNING COSTS (K.U.A.)	230	230	240	240
CONTRACTS (K.U.A.)	←-----	840	-----	→-----



**5.5. COLLABORATION WITH EXTERNAL ORGANIZATIONS**

CEA - Cadarache, Saclay  
CNEN - Bologna  
UKAEA - Risley  
Belgonucléaire - Bruxelles  
BMFT - Bonn  
GfK - Karlsruhe  
AWRE - Foulness  
SNAM - Milano  
CBRA - Bruxelles  
International Energy Agency (I. E. A.)

Table E-I-01/h - PLANNING

<u>REACTOR SAFETY</u>				
Project : Dynamic Structure Loading and Response				
<u>PLANNING</u>				
ACTION	1977	1978	1979	1980
1. a COVA TESTS COVA THEORY	←→			
2. b Single subassembly event Clusters tests & theory	←→	←→	←→	←→
c Pressure wave propagation in piping systems			←→	←→
d 3-D analysis of structure loading and response				←→
2. a Temperature and irradiation effects on dynamic mat. properties	←→	←→		
b Biaxial effects on relationship	←→	←→	←→	←→
c Wave propagation effects			←→	←→
d Constitutive laws for composite materials	←→	←→		
e equation of state of liquids submitted to tension waves	←→	←→		

TABLE E-I-01/i

EXPERIMENTAL AND ANALYTIC APPROACH TO EXPLOSION CONTAINMENT

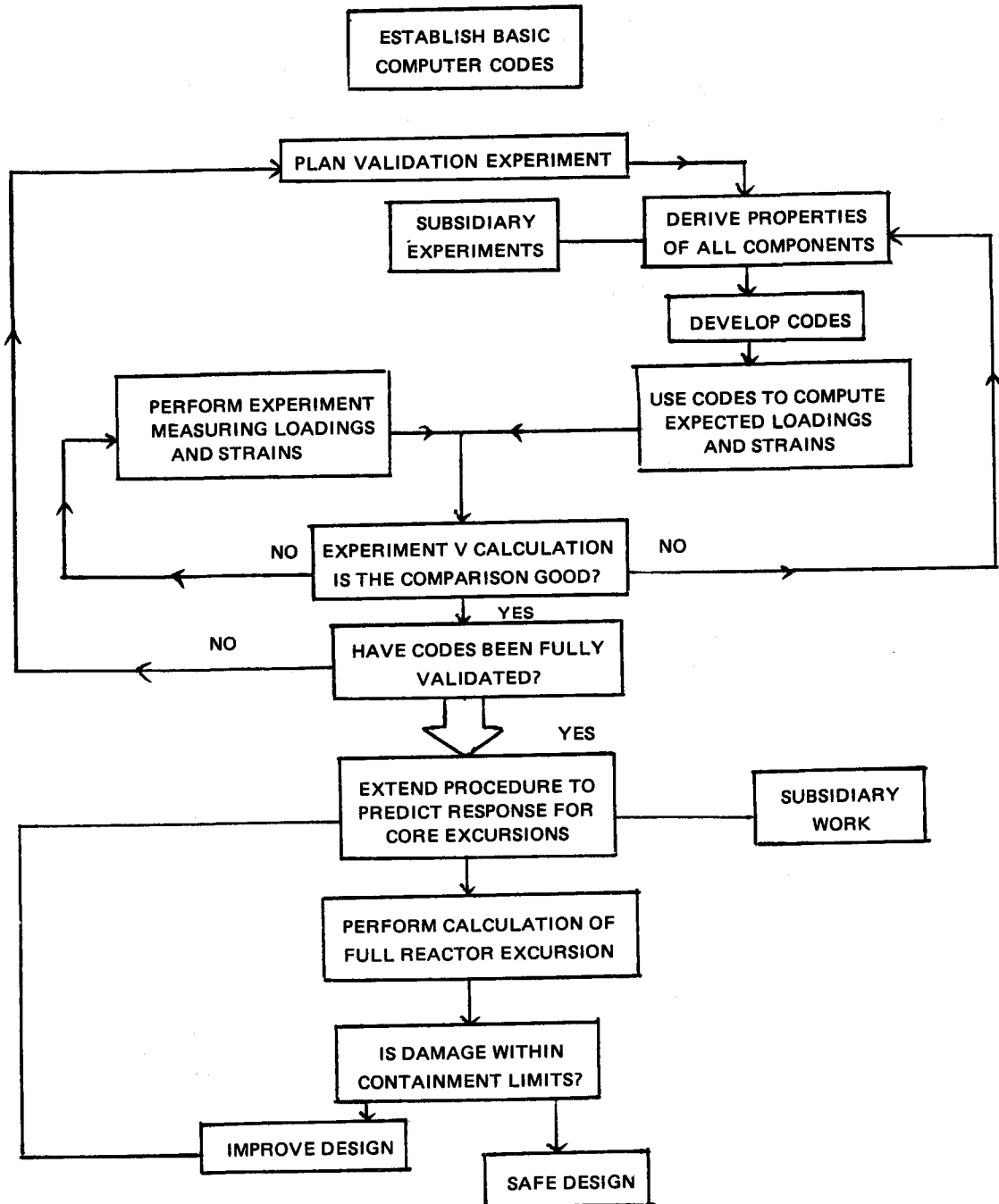

## STATE OF THE ART

States Research items	J.R.C. ISPRA	U.K.	FRANCE	DEBENELUX	ITALY	U.S.A.	JAPAN
PRIMARY CIRCUIT	Codes: Rexco (Ispra) Astarte Ares Surbcum SNR + PEC proj. Code validation	Codes: Astarte Surbourn Code valid. progr. with ISPRA Work for PFR	Codes: Andreas Work for Phoenix and super	Codes: ARES DRAP KOLSCH Yaqui Piping Exp. with ISPRA	Codes: Asprin  Exp. with ISPRA	Codes (ANL): Rexco JCECO JCEPEL (piping)  Experiments at SRI for FFTF	Codes: Lagr. + Eulerium  Experiment for MONJU
CORE INTERNALS including fluid desorption	Codes: Eurdyn 1,2 Exp. for CNEN	Codes: Eurdyn 1,2 Experimental work for SNR + PFR	UNKNOWN	Codes: Karlsruhe Basic static + dynamic tests	Work per- formed with ISPRA	Codes: Straw Sad cat Tests at SRI	UNKNOWN
Material properties under dynamic load  Equations of state	Mon. dim. tests Two dim. tests Wave propagation tests Composite materials	Foulness collab. with ISPRA Tests on comp. material	small activity University	Collab. with ISPRA + Petten	collab. with ISPRA	Center of dynamic plasticity SWRI Hanford Lab.	UNKNOWN

**TABLE E-I-01/k SUGGESTED BALANCED ISPRA TEST SEQUENCE**

TEST	EXPT TYPE	DESCRIPTION
IT1	111	Short rigid tank, HE
IT2	111	Repeat of IT1
IT3	111	Repeat of IT1
IT4	511	Long rigid tank, HE
IT5	611	Long rigid tank, LDE (all LDE in subsequent tests)
IT6	621	Long thin tank
IT7	622	Long hemispherical bottomed tank
IT8	222	Short hemispherical bottomed tank
IT9	622	Repeat of IT7 with different water height
IT10	251	Short rigid tank, rigid inner, rigid diagrid
IT11	251	Short thin tank, rigid inner, rigid diagrid
IT12	251	Short rigid tank, thin inner, rigid diagrid
IT13	253	Short rigid tank, thin inner, perforated diagrid
IT14	653	Long rigid tank, thin inner, perforated diagrid
IT15	234	Short rigid tank, roof supported diagrid
IT16	234	Short thin hemispherical bottomed tank, roof supported diagrid
IT17	254	Side supported rigid diagrid
IT18	242	Short rigid tank, spaced NS, inner and outer constraining tanks
IT19	242	Short thin tank, spaced NS, outer constraining tank
IT20	671	Long thin tank, thin inner rigid diagrid dip plate
IT21	671	Long thin tank, thin inner, perf. diagrid dip plate
IT22	272	Short thin tank, rigid inner, rigid diagrid, conical deflector

## 6. PROJECT : STRUCTURAL FAILURE PREVENTION

### 6.1. BACKGROUND

The most basic and natural foundation of structural failure prevention consists of a good knowledge of the processes and associated laws which lead to failure. Limiting the discussion to the rupture type of failure, it is more and more recognized that the consideration of "defects" is of primary importance and should be integrated in structural design: the impressive development of fracture mechanics in the last 15 years has reached undeniable results in that direction, which have permitted for instance, the integration in the ASME code - section III and section XI - of specific rules for protection against crack propagation and instability.

However important limitations in the present status of knowledge and procedures in this field are generally recognized. For instance :

- the evaluation of cracks under situations of elastoplastic response is not developed to the point reached for the linear elastic case.
- the probabilistic approach of design against crack induced failure needs to be developed (probabilistic fracture mechanics).
- for high temperature structures such as those of LMFBR, the existing design rules (such as ASME code 1592) do not take into consideration at all crack induced failure.

For this last case, two subjects remain of primary importance because they have an influence on the general LMFBR safety philosophy, namely, on the probability of a core disruptive accident and on the need to include this event in the design basis.

The first subject is that of the primary piping integrity (essentially for loop-type LMFBR). The question is whether a sodium spill due to a crack having penetrated the piping wall may reach such an amplitude as to entail a dangerous loss of core cooling capacity. The question is directly connected to the dimension of the "through cracks" to be assumed, which in turn depends on the crack growth mode and rate in piping and other components of a more complex shape, and on the possibility of reaching a critical crack length, which would mean propagation on a larger scale. Damaging effects such as aging, welds etc. and special loading conditions such as thermal shock should be included in this evaluation.

The second subject is the integrity of the core support structures, which are submitted to primary loading and to irradiation. For this typical loading, geometry and irradiation conditions, it is necessary to evaluate the dimensions of the critical cracks and, taking into account the difficulty of inspection in this region, to prove that existing initial defects cannot grow in service to such dimensions.

A third subject must retain attention as long as core disruptive accidents are included in the design basis : that of the significance of cracks in the primary vessel submitted to impulsive loading beyond general yields. It is important to decide if the most limiting failure criterion used to specify the acceptable strain in these accidental conditions is based on crack tolerance, or on general plastic collapse.

Even in the "classical" aspects of the high temperature structural design, such as is presently contemplated by the ASME code case 1592, large areas of uncertainties and insufficient knowledge are generally recognized. They concern :

- the development of stress/strain computation methods in which time dependent deformation processes and the influence on them of loading history can be taken in consideration properly :
- the development of constitutive equations representing the deformation behaviour of the material
- the definition of correct damage accumulation and failure criterion under combined creep/fatigue conditions.

For the latter aspect, the problem of extrapolation to long times (30 years of plant life) of the failure rules based on short term experimental investigations seems especially important and it is felt that only an increase in knowledge on the creep/fatigue damage mechanisms could provide a reliable foundation for this extrapolation.

The short discussion above has already indicated which directions are intended for the proposed work. It will be concentrated on LMFBR structural problems and will concern :

6.1.1. in relation to design against crack growth failure :

- the study of criteria for crack instability and the evaluation of typical embrittlement effects (irradiation), for static and dynamic loading.
- the macroscopic crack growth laws under fatigue creep and their combination
- in support of the above items the study of microscopic processes of crack growth and instability ;

6.1.2. in relation to the "classical" design of high temperature structures :

- the study of creep damage in austenitic stainless steels, using the density variation as a characterizing parameter ;

6.1.3. in relation to the probabilistic aspects of fracture :

- the development of a probabilistic model of stress corrosion cracking (relative to LWR).

Engineering orientated research under item 6.1.1. is already in progress at JRC -Ispra either in the form of projects pursued in co-operation with external bodies involved in LMFBR development or purely domestic projects within the scope of a better orientation inside vast subjects such as fatigue crack growth and creep crack growth. It is intended to accentuate the project orientation of this part of the work using co-operation contracts as a means of forging external bonds with national projects.

However, it is felt that a more fundamental and metallurgical approach would be necessary in some areas. For instance, the study of the microscopic processes of deformation and rupture at the crack tip could contribute to the validation of the elasto-plastic fracture criteria used in the research item 6.1.1..

In the same way the existence and the level of threshold in fatigue crack growth of stainless steel - the practical importance of which is obvious - could be better understood and supported if related to the crack tip cyclic deformation process.

It seems therefore reasonable to take advantage of the pluridisciplinary character of the JRC to found, on a more fundamental basis, the work in progress which is to be developed in the field of design against crack failure in stainless steel structures.

As the problems connected with high temperature design are the subject of large research programmes in Europe, the U.S.A. and Japan, it seemed wiser to limit the JRC under 6.1.2. above, relying on the available expertise in Ispra in creep cavitation studies which looks promising in bringing an original and new insight into the problem of creep damage modelling and prediction.

Finally the probabilistic approach of design against crack failure will be tackled by a project concerned with the development of a probabilistic model for failure under stress corrosion cracking. This is the only "failure genesis" study which will concern LWR and not LMFBR. A motivation for this fact can be found not only in the expertise available in Ispra in the field of stress corrosion, but also in the highly stochastic character of the cracking resulting from this phenomenon which gives a high significance and priority to a probabilistic approach. Expertise existing in Ispra in the field of structural reliability will guarantee a reasonable guidance for this part of the work, of which it is hoped a later development concerning probabilistic modelling of failure processes such as creep, fatigue and unstable crack propagation will emerge.

- 6.1.4. A very important element for the reactor safety is the availability of diagnostic techniques allowing the detection, throughout the whole life of the reactor, of the first initiation of defects or malfunctionings which could cause dangerous accidents (core accidents).

Potentially, quite dangerous are fissures and cracks which break the integrity of the vessel and of the primary circuit, as well as modifications of the characteristics of the core or of some other components of the circuit, such that big hydraulic and thermal perturbations can be originated.



From an R&D point of view, the problem of the availability of the above mentioned diagnostic techniques has two aspects. The first aspect is that of the development of a certain technique up a level enabling its industrial application. The second aspect is the possibility of evaluating the real, operational reliability of techniques having already reached the stage of industrial application.

## 6.2. TECHNICAL DESCRIPTION

### 6.2.1. Failure genesis

#### 6.2.1.1. Crack instability and embrittlement effects in LMFBR structures

The central part of the work will concern the practical application of elasto-plastic fracture concepts (J-integral, C.O.D. and others) to the following specific problems :

- Assessment of the significance of cracks in a LMFBR primary vessel under accidental impulsive loading (Core Disruptive Accident).

This work implies dynamic toughness testing on cracked specimens, development of software for static and dynamic elasto-plastic stress/strain analysis and validation experiments on cracked stainless steel plates and vessels loaded up to full yield, both statically and dynamically.

- Assessment of embrittlement effects due to irradiation in LMFBR core support structures.

The work will concern essentially toughness testing on irradiated specimens. The work already in progress should be pursued with tests on specimens of larger dimensions combined with other damaging effects such as welding and temperature aging.

#### 6.2.1.2. Fatigue/creep crack growth in stainless steel structure

The work is aimed at investigating crack growth laws under fatigue, creep and combination there of with the view of demonstrating the reliability of the primary coolant boundary and other vital structures of LMFBR. The work will be pursued according to the lines of the current programme, with a special consideration given to the following areas :

- Investigation of the threshold effect in fatigue crack growth (environmental influence) ;
- Influence of frequency, hold time and load cycle combination ;
- Study of geometrical and typical loading effects, especially crack initiation and growth under thermal loading and pressure cycling in tubes ;
- Basic investigations on creep crack growth.

### 6.2.1.3. Study of microscopic processes of crack growth and instability

This part of the programme should be intended as a basic support to part 6.2.1.1. and 6.2.1.2.. As a first step it is aimed to contribute to the J-integral concept, under the following aspects :

- verification of the hypothesis of Rice on this contour integral,
- validation of the relation between the integral itself and its energetic counterpart :  $(dU/da)$ .

These investigations will be based on the measurement of the deformation tensor field around the crack during crack extension : experiments will be carried out in a Scanning Electron Microscope, using an in-situ straining device, and observing the evolution of a grid of marks placed on the strained samples.

Parallel phenomenological observations on these samples may be performed :

- slip lines generation in the plastic region and surfaces of slip lines arrest related to stress concentration ,
- void formation and coalescences,
- rupture mechanisms around inclusions, i. e. at the interface inclusion-matrix, or of the inclusion itself,
- crack tip blunting with corresponding shear,
- the short ramification of the crack and its preferential direction.

Moreover it is intended to improve the understanding of phenomena occurring in the material concerned before and during crack extension, especially at crack onset, recording simultaneously the ultrasonic waves emitted during the loading experiment in the S.E.N.. A later step will concern the investigation of the physical processes of deformation and rupture under cyclic loading in support of practical problems encountered in fatigue crack growth behaviour, such as the existence of a threshold or the sensitivity of the fatigue crack growth rate to frequency.

### 6.2.1.4. Creep damage modelling

This is essentially aimed at developing a phenomenological model of creep cavitation in AISI 304 steel. This model will be based on experimental results of specimens loaded mono-axially and bi-axially at high temperature, in which the creep damage will be monitored by the density variation and metallographic examinations.

A correlation will be attempted between these damage parameters and engineering damage parameters (such as those put forward by Kachanov and Rabotnov) in view of the improvement of prediction of structural lifetime.

#### 6.2.1.5. Probabilistic modelling of stress corrosion damage

Starting from the more recently proposed mechanisms of stress corrosion cracking, especially using those involving fracture mechanic concepts - probabilistic models will be developed. These models will relate the distribution of microcracks with the expected residual lifetime to failure. It is hoped that this approach will lead to the definition of quantitative criteria for failure prediction.

#### 6.2.2. Failure detection

##### 6.2.2.1. Application of the ultra-acoustic emission to the detection, characterization and location of cracks and leaks

The ultra-acoustic emission (or stress wave emission) is a phenomenon of well acknowledged interest for diagnostic purposes. It is, for example, used for the detection and location of cracks in vessels during pressurization tests and in weldings during their cooling.

The main problems not yet completely solved for the use of this technique as a crack detector, are :

- signal characterization, in order to extract the location in a noisy environment,
- real-time elaboration of the signals (the difficulty is due to the high frequency of the signals and the complexity of some elaborations).

Towards the solution of these two problems, Ispra has developed original approaches whose final goal is the on-line monitoring of a plant by digital techniques.

Ultra-acoustic emission seems to have quite interesting possibilities of practical applications for the remote detection of leaks. For this application, the method (developed at Ispra) of source location, by use of the cross-correlation functions should be of particular usefulness.

The work will be divided into three parts :

- statistical characterization by means of the techniques of analysis of non-stationary random processes of ultrasonic signals corresponding to crack formation and propagation in steels,
- experiment of crack-monitoring in real time on a pilot circuit using digital methods (i. e. assembling the techniques developed at Ispra : heterodyning, statistical characterization, location by cross correlation).

- location and characterization of various types of leaks.

### 6.2.2.2. Reliability of conventional non-destructive techniques

Among the actual techniques for the non-destructive testing of nuclear reactors (i. o. vessel, core, primary circuit) radiography and ultra-sounds are principally used. Experience, however shows that there are often doubts on results obtained when these N. D. T. techniques are applied.

Moreover, increase in performance of the materials and more and more severe criteria made it necessary that the N. D. T. techniques be used in such conditions that reliable results may not be obtained when actual techniques are simply applied.

- Critical analyses of the transfer functions of standard ultrasonic testing chain in order to assess the influence of the various parts and of the operational conditions on the overall capability and reliability.
- Study of the correlations between ultra-sonic, signals and reference artificial defects. This study will involve the use of the N. D. T. techniques, destructive techniques and the fabrication of well defined artificial defects.
- Practical applications.

### 6.3. PLANNING

REACTOR SAFETY				
Project Structural Failure Prevention				
ACTION	1977	1978	1979	1980
<u>Dynamic Fracture studies</u> (HCDA conditions)				
Code development	←-----→			
Dynamic fracture toughness tests	←-----→			
Static general yielding tests		←-----→		
Dynamic validation tests			←-----→	
<u>Irradiation effects</u>				
2nd irradiation	←-----→			
3rd irradiation		←-----→		
<u>Fatigue/creep crack growth</u>				
- thermal shocks in tubes	←-----→			
- part-through cracks in tubes		←-----→		
- fatigue parametric studies	←-----→			
- creep crack growth	←-----→			
<u>Microscopic processes</u>				
Design of experiments in SEN	←-----→			
Experiments in SEN		←-----→		

ACTION	1977	1978	1979	1980
<u>Basic Studies on SWE</u>	←-----→			
Correlation between SWE and SEN observations			←-----→	
Analysis of the results		←-----→		
<u>Creep damage modelling</u>				
Materials supplying and specimens preparation	←-----→			
Creep experiments	←-----→			
Differential density measurement and quantitative metallography		-----→		
Models elaboration		←-----→		
<u>Stress Corrosion Damage</u>				
Laboratory tests	←-----→			
Analysis of actual components		←-----→		
Model elaboration		←-----→		
Application of the results to safety analysis		←-----→		
<u>Ultra-acoustic emission</u>	←-----→			
<u>Reliability of Conventional N. D. T.</u>	←-----→			

#### 6.4. MANPOWER AND COSTS

PROGRAMME : REACTOR SAFETY				
PROJECT 6 : STRUCTURAL FAILURE PREVENTION				
	1977	1978	1979	1980
RESEARCH STAFF	40	40	40	40
INVESTMENTS (K.U.A.)	←----- 530 -----→			
RUNNING COSTS (K.U.A.)	360	360	370	370
CONTRACTS (K.U.A.)	←----- 410 -----→			

6.5. COLLABORATION WITH EXTERNAL ORGANIZATIONS

INTERATOM - Bensberg/Köln

CEN - Brussels

UKAEA - Risley

CEA - Saclay

AGIP NUCLEARE - Milan

RCN - Petten

GfK - Karlsruhe

TU - Berlin

CNEN - Bologna

SNAM - Milan

ADVISORY COMMITTEE  
ON PROGRAMME MANAGEMENT

-----  
"REACTOR SAFETY"

RECOMMENDATIONS of the Advisory Committee on Programme Management for Reactor Safety Research Concerning the Current Programme of the Joint Research Centre, Ispra, and the OPINION on the Programme Proposed by the Joint Research Centre, Ispra, for 1977 - 1980

---

The Advisory Committee on Programme Management for Reactor Safety Research held three meetings in 1975 and focused its discussions on the new multi-annual programme.

With regard to the assessment of the current programmes there were no basically new aspects in comparison with the previous year. The Committee discussed the progress achieved by referring to the annual report for 1974 and the quarterly reports submitted. It again laid emphasis on its concern regarding the postponement of the deadlines for several important projects, in particular the Blow-Down project.

In discussing the current programmes and their continuation during 1976, the Committee endeavoured to identify connecting links for future work, in order to guide and assist the Joint Research Centre, Ispra, both before and during the implementation of the new multiannual programme, so that research on reactor safety is geared as closely as possible to the requirements of the Member States of the European Community. In this respect the Committee fell in with a wish expressed by the General Advisory Committee (see document CCG 157).

At its last meeting on 26-27 November 1975, the Committee discussed the draft submitted by the Joint Research Centre, Ispra, for the new multi-annual programme in the field of reactor safety research, and adopted the following opinion thereon:

General Remarks

The Committee approves the general technical content of the programme, but cannot yet express any opinion on the proposed budget and personnel to be assigned to the individual projects. It expresses satisfaction that the programme proposal provides for the condensing of all research into six central projects and thereby falls in with the Committee's earlier recommendations. However, concentration on central project objectives must be systematically carried through in the detailed planning of the six projects. The proposed description of the projects is not yet

sufficiently clear to say anything specific at the moment. The Committee reiterates its earlier recommendation that all analytical work and code development should be geared to the experimental investigation and that close dovetailing of theoretical and experimental work must be ensured by means of appropriate organization. Continuity between the old programme and the new one seems eminently desirable, but no projects should be included in the new programme simply in order to make use of available equipment and special experience.

On the basis of experience with existing specialist groups, namely:

- Reliability
  - Subassembly Fault Analysis
  - Blow-Down B
  - Containment Loading and Response
  - Whole Core Accident Codes
- study groups under the "Fast  
Reactor Safety Working Group"

The Committee proposes the formation of two other specialist groups:

- Core Melt Down and Fuel Coolant Interaction
- Structural Failure Prevention

These groups would discuss the technical details of all topics covered by the six main projects and give recommendation on how they are to be implemented.

The following specific comments and recommendations were made on the six projects:

#### Reliability and Risk Assessment

The project is regarded as useful and important. The work involved is defined very broadly so some restrictions in specific tasks will be necessary. Research under heading 1.1. "Acquisition and Evaluation of Codes for Mechanistic Accident Analysis" should be concentrated on the development of a whole core accident code (WAC) for sodium cooled fast breeder reactors.

Research under heading 1.2. "LWR-Core Accident Probabilistic Analysis" should take fully into account the knowledge and experience on which the Rasmussen Report is based. The aim of the research should be the further development of methods for a probability-oriented accident analysis and



the demonstration of progress achieved on the basis of particularly important examples of application. Research under heading A.3. "LMFBR Core Accident Probabilistic Analysis" seems premature and should be shelved for the time being.

Activities under heading I.4. "Set-Up of a European Reliability Data System" should be tackled immediately, but restricted in the first stage to stock-taking and analysis of existing national projects in this field.

#### Project II - Light-Water Reactor Loss-of-Coolant Accident

The "Blow-Down Loop Project" (heading II.1.) should receive special priority. This applies above all to the budget and manpower requirement of this project. Activities under II.2. "Blow-Down Theory and Codes" are exceptionally important and should be closely dovetailed with experimental investigations (II.1.). The main tasks in this connection are precalculations for the blow-down test, evaluation of the test results and further development of physical models in existing codes, in so far as this appears necessary on the basis of the experimental results. The Committee is concerned about adherence to the schedule for this project, even if all the proposed resources are made available. Investigations under heading II.3.1. "Heat Transfer Crisis in Blow-Down Conditions", II.3.2. "Hydraulic Oscillation Experiment" and II.3.3. "Two-Phase Mass Flow Through Convergent Nozzles" appear interesting in principle, but aims and measures should first be discussed in detail in the expert Working Party "Blow-Down B".

Continuation of the project "Experimental Study on Interchannel Mixing and Cross-Flow in Rod Bundle Sections", which is being carried out under existing collaboration contracts with CNEN and BMFT, is recommended. However, the Committee recommends that project "Experimental Studies on Rod Bundle Heat Transfer During Reflooding" be abandoned and that the large core flooding experiments proposed by IRS be excluded from programme planning.

#### Project III - Liquid Metal Fast Breeder Subassembly Thermohydraulics

The project which has already been discussed in the expert working party "Subassembly Fault Analysis" is generally approved. Only on project III.3.3. "Cluster Boiling Experiments in Small Bundle Geometry" are the British and German delegations still withholding their opinions, in order to leave the experts to discuss once again the additional value of the proposed research. Research should be mapped out with due regard to the requirements of the WAC work (I.1.).

Project IV - Core Melt Down and Fuel Coolant Interaction

The Committee gives high priority to this project as a whole. Opinions were divided only on the priority of the proposed four-years programme on fuel coolant reaction. Details of the projects should, however, first be discussed in an expert working group to be set up for the purpose. Individual projects should be defined, having regard to national programmes, so that they provide new or complementary information and thus afford interest for all the member countries.

The proposed activity on an integral experiment on heat removal from melted fuel should be closely integrated with national projects in this field. The Committee sees this important item as an opportunity for a European project involving both national research establishments and the JRC, to make a substantial contribution towards reactor safety.

Project V - Dynamic Structural Loading and Response

The Committee considers the project important and gives priority in particular to points A and B, some members also to point C, of the research under V.1. "Code Development and Validation". The research on components envisaged in connection with B and C should be carried out in close contact with industry in order to ensure realistic testing and a practically-oriented line of approach.

Research planned under D, on structural effects of an aircraft accident, should be eliminated in the Committee's view.

As regards heading E, the Committee feels that the proposed programme could be very expensive and is agreed only on a feasibility study, which should be discussed in the experts working group on "Containment Loading and Response".

Heading F was given fairly low priority.

Research under V.2. "Determination of Material Constitutive Laws" is highly important and should be designed to contribute to a broader understanding of fundamental principles.

Project VI - Structural Failure Prevention

The project is generally approved as a whole. Research should be carried out with due regard to national programmes in this field. To this end, details of the project should be discussed in the expert working group on structural failure prevention, to be set up by the Committee.

The experimental part of the work at Ispra should concentrate on the examination of samples. Later, special emphasis should be given to theoretical work to allow test results to be applied to components. In this way a link would be established with research on large components which is mainly carried out under national research programmes. The proposed work under heading IV.2.1. on "Application of the Ultra Acoustic Emission to the Detection, Characterization and Location of Cracks and Leaks" and VI.2.2. "Reliability of Conventional Non-Destructive Techniques" should be severely limited. Activity under VI.2.3. "Loop for the Operation Set Up of Techniques for Incipient Failure Detection" and VI.3. "Mass Transport by Coolant" should be abandoned.

## 2. PLUTONIUM FUELS AND ACTINIDE RESEARCH

PROGRAMME

PLUTONIUM FUELS AND ACTINIDE RESEARCH

TABLE OF CONTENTS

INTRODUCTION

1. PROJECT: UTILIZATION LIMITS OF PLUTONIUM FUELS

1.1. BACKGROUND

1.2. TECHNICAL DESCRIPTION

1.2.1. Swelling of Advanced Fuels

1.2.2. The Mechanism of the Reaction Between Mixed Oxide and Stainless Steel

1.2.3. The Thermal Behaviour of Fuel Pins Under Irradiation

1.2.4. Equation of State of Nuclear Materials

1.3. MANPOWER AND COSTS

2. PROJECT: PLUTONIUM AND ACTINIDE ASPECTS OF THE SAFETY OF THE NUCLEAR FUEL CYCLE

2.1. BACKGROUND

2.2. TECHNICAL DESCRIPTION

2.2.1. TACO: Determination of Integral Cross Sections and Fission Yields in Fast Reactors

2.2.2. FACT: Formation of Actinides in Pile

2.2.3. SHAPE: Safe Handling of Plutonium Compounds

2.2.4. RECARB: Some Aspects of the Head-end Processing of Carbide Reactor Fuel

2.3. MANPOWER AND COSTS

3. PROJECT: ACTINIDE RESEARCH

3.1. BACKGROUND

3.2. TECHNICAL DESCRIPTION

3.2.1. Preparation and Characterization

3.2.2. Investigation of Properties

3.3. PLANNING

3.4. MANPOWER AND COSTS

## APPENDIX E-I-02

## PROGRAMME

PLUTONIUM FUELS AND ACTINIDE RESEARCHINTRODUCTION

The special properties of plutonium and the other actinides (alpha radioactivity and toxicity), which demand very specialized installations and equipment for the execution of the experimental work, characterize this programme. Consequently, it is to be primarily executed in the Karlsruhe establishment of the Joint Research Centre (European Institute for Transuranium Elements) which has been constructed to concentrate the direct actions in this particular field.

Thus, the Institute simultaneously fulfils a central role and serves as a focal point according to the criteria which have been elaborated in chapter 2 of this document.

The general motivation for this research is the contribution to the development of safety of the nuclear fuel cycle, which cannot neglect problems concerning plutonium (and the elements stemming from it) in the phases of production, utilization, examination, refabrication and waste disposal.

Amongst the numerous problems in this field, a choice had to be made. The chosen activities deal on the one hand with the general needs of the Community which are not covered by national laboratories (such as certain aspects of advanced fuels for fast reactors, which partly have been delegated to the Karlsruhe JRC establishment on the basis of a common agreement) and on the other hand with questions treating the safety of the fuel cycle, limited to aspects of plutonium and other actinides.

Finally, the field of fundamental research on actinides will be treated in this programme which thus is balanced with regard to the distribution between work of short-, medium- and long-term usefulness.

A certain part of the potential of these activities can be used for the execution of work requested in connection with national projects. This is in perfect agreement with one aspect of the mission of the JRC, viz., putting its specialised competence and available equipment at the disposal of industry or national centres.

In order to obtain maximum efficiency, general problems shall be treated which are common to several specific fields of the nuclear fuel cycle and thus to specific Community or national programmes.

Evidently, there should be a useful "spin off" for other programmes such as the "Reactor Safety" (direct action) and "Nuclear Materials and Radioactive Waste Management" (direct and indirect actions) as well as for "Plutonium Recycling" (indirect action) which benefit from this medium-term basic research of general interest. Special attention will be given to coordinating this effort.

The investigations of the programme presented will be executed in the JRC Karlsruhe establishment if their nature so demands; a part (evaluations, modelling activities, analyses, e.g.) will be performed in other establishments of the JRC possessing the specific competences required. This latter part, subject to fluctuations due to dynamic programming, might for the next multiannual period cover some 10 to 15 per cent of the research staff allocated to the programme.

On the other hand, the direct actions mentioned above will charge the JRC Karlsruhe establishment with the execution of certain specific parts of the research, as indicated in the corresponding programme proposals.

This will lead to a better cohesion of the JRC research, a better utilization of the available potential and a higher degree of interpenetration of the activities performed in the various laboratories of the JRC.

As the present programme (1973-1976) is, to a large extent, dealing with basic medium-term research, useful for future technological development, and partly with long-term fundamental research, it follows that some of the present activities will extend into the next multiannual programme. However, within the frame of a dynamic programming, a reappraisal of the priorities will be made during the next programme in order to ensure the most efficient utilization of the means and the adjustment to the actual (and changing) needs. This could involve the discontinuation of certain studies in favour of others.

The programme consists of three projects, viz.:

Project 1: Utilization Limits of Plutonium Fuels

Project 2: Plutonium and Actinide Aspects of the Safety of  
the Nuclear Fuel Cycle

Project 3: Actinide Research.

Please note that for manpower and costs two hypothesis (A and B) have been described, each corresponding to the most efficient utilization of means, the final choice not being possible before the end of 1978 ("decision point"), depending on the development of advanced oxide breeders.

SUMMARY OF MANPOWER AND COSTS

PROGRAMME : PLUTONIUM FUELS AND ACTINIDE RESEARCH							
	Research staff (per year)	Investments (M.U.A.)	Total Running Expenditures (M.U.A.)	Resources (M.U.A.)	Required Budget (M.U.A.)	Expected Income (M.U.A.)	
<u>PROJECT 1</u>							
UTILIZATION LIMITS OF PLUTONIUM FUELS	58	0.500	2.400	-	2.900	-	
<u>PROJECT 2</u>							
PLUTONIUM AND ACTINIDE ASPECTS OF THE SAFETY OF THE NUCLEAR FUEL CYCLE	34	0.600	1.600	-	2.200	0.050	
<u>PROJECT 3</u>							
ACTINIDE RESEARCH	29	0.400	1.100	-	1.500	-	
TOTAL	121	1.500	5.100	-	6.600	0.050	

Hypothesis A: Activity "Swelling of Advanced Fuels" continues after decision point end 1978



SUMMARY OF MANPOWER AND COSTS

PROGRAMME : PLUTONIUM FUELS AND ACTINIDE RESEARCH							
	Research staff (per year)	Investments (M.U.A.)	Total Running Expenditures (M.U.A.)	Resources (M.U.A.)	Required Budget (M.U.A.)	Expected Income (M.U.A.)	
<u>PROJECT 1</u> UTILIZATION LIMITS OF PLUTONIUM FUELS	48	0.400	1.900	-	2.300	-	
<u>PROJECT 2</u> PLUTONIUM AND ACTINIDE ASPECTS OF THE SAFETY OF THE NUCLEAR CYCLE	44	0.700	2.100	-	2.800	0.050	
<u>PROJECT 3</u> ACTINIDE RESEARCH	29	0.400	1.100	-	1.500	-	
<b>TOTAL</b>	121	1.500	5.100	-	6.600	0.050	

Hypothesis B: Activity "Swelling of Advanced Fuels" discontinued after decision point end 1978

## 1. PROJECT: UTILIZATION LIMITS OF PLUTONIUM FUELS

### 1.1. BACKGROUND

This project intends to assemble all the activities of this programme which will lead to a better understanding of the in-pile behaviour of plutonium fuels.

Whereas the activities of the present programme (1973-1976) deal with normal fuel utilization conditions, those suggested for the next programme are concentrating on transient or extreme conditions. The knowledge thus obtained is necessary for a better and more precise judgement of the safety margins of essentially advanced fast breeder fuels, both in the choice of the experimental and theoretical approach and of the systems investigated a useful complementary contribution to the studies in the Member States is obtained by the continuous monitoring of the programme through the Advisory Programme Committee.

The study of the mechanisms which determine the in-pile behaviour will be executed along two complementary lines: basic laboratory studies as well as irradiation experiments and post-irradiation examinations. The results are fed into models for use in computer codes for fuel rods. The information obtained should serve for an evaluation both at the economic and the safety level of plutonium fuels.

### 1.2. TECHNICAL DESCRIPTION

The following activities constitute this project:

- The swelling of advanced fuels submitted to high linear rod power and/or high burn-up, especially under power cycling conditions.
- The compatibility between mixed uranium-plutonium oxide fuels and stainless steel canning material under severe conditions; elucidation of the corrosion mechanism.
- The thermal behaviour of fuel rods under irradiation, utilizing special devices for direct in-pile measurements under stable and cycling conditions
- The evaporation of nuclear materials above their melting points.

#### 1.2.1. Swelling of Advanced Fuels

It is currently considered that:

- only advanced fuels will allow the full potential utilisation of FBR's in energy production
- in the 1990s oxide fuels should be replaced by carbides.

This situation could be affected by studies of advanced oxides or reactor concepts which hope to increase the breeding gain for oxides but this does not, for the time being, alter the necessity of a medium-term research activity on advanced fuels.

The current national FBR projects are heavily charged with development tasks and performance tests on oxide fuel for the first generation of FBR's. However, there is an urgent need for basic data and information on advanced fuels and on the fundamental processes of their fission gas swelling. These data are necessary in order to evaluate the development potential of the helium and sodium bonded pin concepts and to correlate the desired values of rod power and burn-up for a given reactor concept with realistic pin models which allow the prediction of the in-pile behaviour of the fuel pin up to the limit of the working conditions.

The research carried out in the frame of the national programmes within the Community can be summarized as follows:

The activity of the DeBeNeLux Fast Breeder Reactor Project on advanced fuels is limited to He-bonded carbide pins. In France the activity is limited to Na-bonded carbide pins. There is also some activity in Italy on advanced fuels and extensive carbide research is carried out in U.K. on both He- and Na-bonded carbides.

Direct contacts exist between the scientists of the national centres working on fast breeder reactor fuels and their corresponding colleagues of the Karlsruhe establishment of the JRC. These contacts take the form of exchange meetings, regular visits, joint participation in certain irradiation experiments (preparation of fuel samples, common design and analysis of certain tests), training of technical personnel and coordination of certain aspects of the research.

In general, it can be stated that on the basis of the line of work established at the laboratory between 1965 and 1970, the distribution of tasks has taken place in continuous contacts with national laboratories.

#### Description of the Activity

During the period 1973-1976 the project has developed a new approach in treating the problem of swelling of advanced fuels which rationalizes a large part of the experimental results by introducing the concept of critical swelling temperature ( $T_k$ ) and by defining three types of swelling (geometrical, local and microscopic swelling). The project is playing a leading part in the analysis of the mechanism of fission gas swelling in advanced fuels within the Community.

There are still five main problem areas in which necessary and sufficient progress has to be achieved before advanced fuels can be used in FBR's as far as the reliability of the fuel is concerned. The aim of the project is to condense the experimental progress to be obtained in the following five areas into a physically realistic model on fuel behaviour:

- Interaction between fabrication porosity and swelling
- Heat transfer between fuel and cladding in He-bonded pins
- Swelling behaviour due to temperature (power) transients
- Mechanical fuel behaviour under power cycling conditions
- Mechanical and (possibly) chemical fuel-clad interactions.

The modelling activities will be performed in cooperation with the services of the Ispra JRC establishment.

### Planning

As in the current pluriannual programme the research will essentially consist of three lines of work which are intimately interrelated:

- irradiation experiments
- laboratory experiments
- modelling.

As already indicated before, the general research situation of fast breeder fuels may change. In consequence a decision point is foreseen around the end of 1978 as to whether pursue or discontinue this activity.

This activity is presently planned so that a realistic fuel behaviour model can be obtained at the end of the four year's period.

The laboratory work will complement the irradiation experiments by thermal simulation with "clean" and burn-up simulated fuel mainly up to the middle of 1979. Thus, the second half of 1979 and the whole of 1980 will be devoted mainly to the understanding and interpretation of in-pile and out-of-pile results, in order to establish the final version of the model. This model would be a natural starting point for describing the fuel behaviour in models of reactor accidents in safety problems.

If this activity is discontinued at the end of 1978, this reduced timing would lead to the following consequences:

- Most of the irradiation results will not be evaluated, because the current irradiation experiments will run until about the second half of 1978, and after discharge from the reactor, the cooling time, transport, post-irradiation examination and data evaluation will take at least one year.
- A physical model with the emphasis on power transients could not be attained, the programme could only treat the steady state model including stress effects.

Swelling of Advanced Fuels 1977/80

		77	78	79	80
I	POROSITY - SWELLING	Irradiations	DN 2 bis		DN 3
		Laboratory	2. sintering in radial grad T as function of porosity		2. sintering in grad T in f.p. doped MC
II	HEAT TRANSFER	Irradiation	CARSON I	Data evaluation	CARSON II
		Laboratory	Simulation with radial Grad T		Data evaluation
III	SWELLING IN TRANSIENTS	Irradiations	steady state model including stress effects	transient model without stress	transient model including stress effects and porosity
			Laboratory	Swelling by selfdamage in MC	
IV	POWER CYCLING and MECHAN. PROPERTIES	Irradiations	GOCAR II	GOCAR III	GOCAR IV
			Laboratory	Swelling by selfdamage in MC	
IV	POWER CYCLING and MECHAN. PROPERTIES	Irradiations	POCY II	POCY III	POCY IV
			Laboratory	Diffusion, vacancies, surf. energ.	
IV	POWER CYCLING and MECHAN. PROPERTIES	Irradiations	SOCRATEM III	SOCRATEM IV	POCY IV
			Laboratory	creep of MC and M(CN) undoped fracture simulation + clad inter-action for MC	
IV	POWER CYCLING and MECHAN. PROPERTIES	Irradiations	M(CN) undoped	M(CN) doped with f.p.	Data evaluation
			Laboratory	MC and M(CN) doped w.f.p.	



Decision Data

### 1.2.2. The Mechanism of the Reaction Between Mixed Oxide and Stainless Steel

Although the inner clad corrosion is at present not the prominent life limiting factor, it may one day become limiting, with successive amelioration of other factors (a "failure rate" of only  $10^{-4}$  being allowed). Thus, this problem deserves a basic research approach to be prepared for optimization demands.

The scientific and technical programmes in this field in the European Community are very firmly incorporated within the framework of the national and multinational projects for the development of fast breeders. Whereas in these programmes the emphasis is usually placed on the technical specifications of steels used as cladding materials and on their properties (mechanical, thermal, etc.) in irradiation conditions and a great part of the work is of a technological nature, run in strict connection with the metallurgical industry, the presented activity is of a basic nature and aimed at a general scientific view of the phenomenon.

The weakening of the clad by corrosion is due to a number of chemical agents and physical actions, the relative importance of which have not, as yet, all been identified. They are either present in the material, mainly in the fuel, or produced under irradiation. A basic approach consists in assigning relative priorities to the different parameters, to provide a unifying model for the complex phenomenon to be studied, and to check this model for its predictions in realistic conditions.

Within the current multiannual research programme of the Joint Research Centre, the present action is the only one investigating the mechanism of the reaction between uranium-plutonium mixed oxide and stainless steel. In operation since 1973, this action has been constantly steered towards the identification of intermediate scientific and technical goals through permanent and ad hoc contacts with national projects, laboratories and industries.

#### Description of the Activity

The European Institute for Transuranium Elements has shown during the past years

- to have developed a new approach in this problem,
- to possess the specific physico/chemical and materials science competence for this task.

The internal corrosion of the standard steel cladding for nuclear fuels is a complex reaction between the standard steel components (especially chromium) and chemical species ("agressors") contained or produced in the fuel pellet (oxygen, fission products). The number of parameters conditioning this reaction is large (local temperature of the inner surface of the clad and of the outer surface of the fuel, temperature gradients, irradiation parameters, nature and concentration of reactants, etc.). A need exists to establish priorities in the importance of these parameters, isolating and understanding reaction mechanisms, and establishing quantitative relationships useful for predictions.

Until now, the activity of the Transuranium Institute concerning this problem has developed in some leading concepts that are basic to investigations.

- a) In its morphological aspect, severe corrosion occurs by anyone of three mechanisms: spalling, intergranular attack and stress assisted corrosion.

The second attack is the most important.

- b) In a very simplified model, the fuel-clad chemical interaction can be described as a successive passage of oxygen, cesium, tellurium, iodine, and other elements over diffusion barriers of various heights. The situation is similar to a complex reaction mechanism the overall rate of which is determined by the slowest partial reaction: here, by the step offering the maximum barrier height for the diffusion of corrosive species. This barrier ought to be identified and if possible its height increased.
- c) The reaction mechanism of cesium and oxygen intergranular attack via a cesium containing molten phase has to be compared with other possible mechanisms.

The problems are approached from two sides:

- 1) basic laboratory studies in order to single out and to determine the importance of specific parameters
- 2) investigations on irradiated pins from various national reactor projects. (It should be noted that in 1978 it will probably be possible to investigate fuel pins irradiated in fast neutron fluxes which are representative of the real fuel composition, i.e. without U-235 enrichment, although burn-up and temperature may be low to begin with).

These two complementary approaches finally meet in a model description, composed of micro-models but covering the whole process of corrosion, to be verified by a specific irradiation experiment.

In the framework of this activity, the expertise of the JRC Ispra in the modelling field will be used.

This activity can be described as follows:

#### Basic Laboratory Research

Parametric out-of-pile studies to determine:

- a) reaction rates between cesium, tellurium, iodine, oxygen and the steel components
- b) the nature and distribution of reaction products.

Complementary studies include: the determination within 7kcal/mole of oxygen potentials of mixed oxides as a function of temperature, stoichiometry, fission products content; a method for

measuring oxygen profiles in the fuel by means of an e.m.f. cell; diffusion studies of fission products in the fuel and in steel.

#### Post-Irradiation Studies

The information collected includes: the axial and radial concentration profiles of oxygen, cesium and other fission products and heavy nuclides; the types, extent and distribution of corrosion in the clad; the nature and distribution of corrosion products. A statistical approach is used in treating these results. The continuous comparison with and feedback to the basic laboratory studies is emphasized.

#### The Corrosion Model

The results of all these studies are fed into a descriptive and at least semi-quantitative model of the corrosion process; this model is the central line of the whole action.

#### The Corrosion Irradiation Experiment (CORROX)

The model shall be tested in an irradiation experiment (CORROX). It might also be possible to investigate qualitatively, in this experiment, means to reduce corrosion by inserting suitable components in the system.

#### Planning

Taking into account the actual development of the oxide fuel, the technical content of this activity will be carried out in a fairly tight time-schedule. The most relevant results should then be achieved during the first half of the next four years' period (till the end of 1978) and, unless it is necessary to continue due to new developments in this field, the action should then be abandoned.



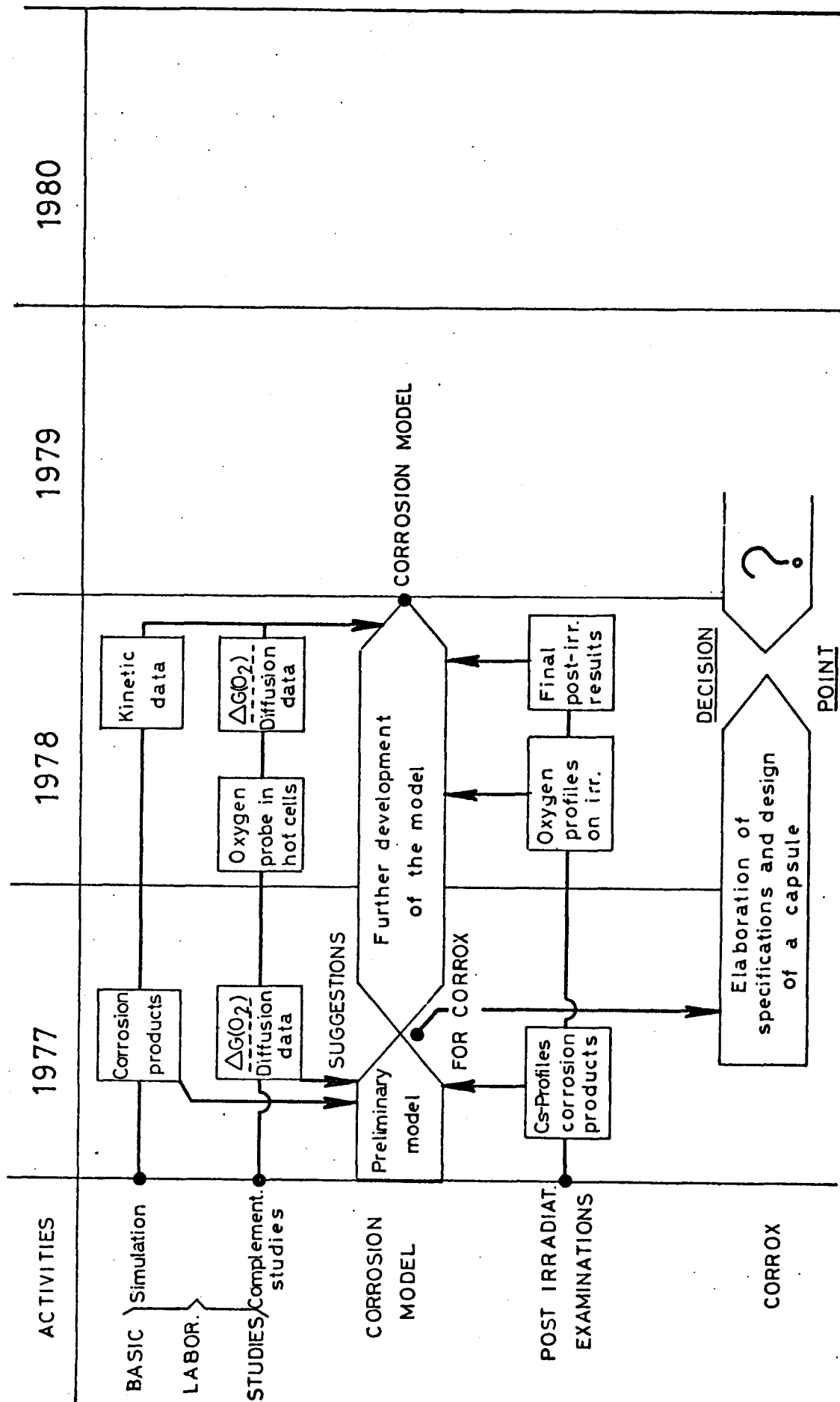

### 1.2.3. The Thermal Behaviour of Fuel Pins under Irradiation

The systematic investigation of the thermal behaviour of fuel is an important element for the exploration of the limits of applicability of plutonium-bearing fuel elements.

Thermal data for fuels under operating conditions are urgently needed for reactor design, safety considerations and post-irradiation analysis, with a higher precision (less than 10% error) than presently available (30 to 50% error), for oxides as well as for advanced fuels.

Attempts to derive thermal mixed oxide and mixed carbide (carbonitride) fuel data from irradiation experiments have been made within the framework of the German-Benelux PSB programme, within the framework of the design of the Rapsodie- and Phénix-fuels in France and on fuel pins irradiated in the Dounreay Fast Reactor (DFR) in the U.K. It seems that none of these experiments is aimed at a systematic study involving critical evaluations and comparisons with model predictions.

The purpose of the operation described here is to achieve a better understanding of the temperature distribution in fast reactor fuel pins under normal and off-normal conditions.

The proposed programme is a logical follow-up to previous efforts in thermophysical fuel property studies, which combined laboratory investigations, instrumented irradiation experiments and modelling activities. It may be noted that out-of-pile data for the thermal conductivity of mixed oxide fuel, determined at the European Institute for Transuranium Elements are used and referred to in many laboratories within the Community and abroad.

A programme to study the thermal behaviour of light-water reactor fuel pins is being currently carried out in the Halden reactor in Norway. Besides thermocouples, the Halden Group uses ultrasonic thermometers, working at moderate temperatures (1200 to 1600°C).

#### Description of the Activity

The programme proposed here involves the use of a multi-sensor ultrasonic thermometer, able to measure the temperature profile along the centreline of a fuel pin in a reactor. At a later stage it is foreseen to determine at the same time the thermal conductance between fuel and cladding by a thermal oscillator technique under study.

The multi-sensor thermometer (TRESOM) developed at the Institute, should - in contrast to similar developments in other laboratories - be capable of measuring temperatures at and above 2350°C over prolonged periods of irradiation time (one hundred to several hundred hours).

The use of a thermal oscillator technique for the in-pile determination of gap conductances has been recommended on several occasions. Encouraging preliminary results with this technique have recently been reported from Idaho Falls.

It is proposed to carry out within the next programme period irradiation experiments with oxide fuel pins equipped with ultrasonic thermometers. Tests will be made under steady state conditions, during soft and sudden power changes, in a thermal reactor, and if possible in a fast flux.

Experiments are being planned where temperatures in advanced fuels are to be determined, hopefully in a fast flux.

The two last tests of each series will be provided with facilities to vary the mean fuel temperature periodically in order to determine their thermal gap conductance during in-pile operation.

The materials parameters and irradiation conditions for each experiment will be carefully defined and fed into TPROF computer code, developed at the Institute, and into other comparable codes, if available. The data predicted by the model(s), i.e. central fuel temperature and gap conductance as a function of irradiation history, will be compared with the obtained experimental results, and a feed-back mechanism will be employed to trace the origin of any major inconsistency.

These tests will be complemented by laboratory experiments: the heat transport parameters of mixed oxides and advanced fuels of various compositions will be measured, if necessary, up to and above the melting point.

#### Planning

		1977	1978	1979	1980
Oxide Fuels	Aims	Steady state calibration	Behaviour at variable loads	Gap conductance investigations	
			Verification of applicability to fast flux		
Advanced Fuels	Aims	Steady state calibration, in fast flux, if possible	Behaviour under steady and variable load. Gap conductance studies. Two types of fuel.		

#### 1.2.4. Equation of State of Nuclear Materials

The behaviour of nuclear materials, essentially plutonium compounds, at very high temperatures (between the melting point and the critical temperature) needs sophisticated investigations which follow strictly the basic multifunctional approach of this part of the programme's concept. The problem, especially for plutonium-uranium mixed oxides has been discussed at the European Institute for Transuranium Elements over the past 10 years, but gained new momentum by the initiative within the Community to charge the TU-laboratory with these investigations because a central effort seemed to be well indicated for financial reasons and on the basis of the Institute's well established competence in high temperature chemistry. Thus, this part of the programme has been in operation since 1973 as part of the Common Research Programme.

Up to 1973 the approach to this question has been mainly theoretical (see below). The experimental approach is new and demands the development and testing of special equipment.

The national programmes within the Community in the experimental field are limited to one action in the national Karlsruhe research centre, making, however, use of a different technique (recoil momentum of the vapour jet leaving a surface heated by a CO<sub>2</sub> laser with a lower pulse limit of msec). This approach confirms the results obtained in the frame of the present activity, the complementary and relative importance of the two approaches being judged by the responsables of the sponsoring project who insist on the continuation of the Joint Community effort.

Theoretical determinations of the critical data of UO<sub>2</sub> have been performed in the Risley and Harwell laboratories of the UKAEA in Great Britain and by theoreticians of the GfK (Federal Republic of Germany), in close co-operation with this Community action.

Similar experimental investigations are reported from the Mitsubishi laboratories in Japan and theoretical investigations from the Argonne National Laboratory (USA).

##### Description of the Activity

The programme has three parts:

1. Sufficiently high temperatures must be generated at the surface of a solid sample.
2. This temperature has to be determined with sufficient precision.
3. The evaporating species have to be identified and determined quantitatively.

All this involves the development and amelioration of new experimental techniques by entering into fields of higher temperatures and shorter reaction and observation times than before.

As to the nuclear materials systems to be investigated, a step-wise approach from simpler systems (such as  $UO_2$ ) to more complicated ones (uranium-plutonium-caesium-oxide systems) is indicated.

### Planning

Part of the plan has been fulfilled during the period 1973-1976, the largest part, however, constitutes the programme 1977-1980.

During that period, mainly advanced plutonium fuels will be investigated with or without fission products, proceeding to complex systems also involving cladding materials and coolants.

The supporting and complementary theoretical studies will involve general critical data assessments, gas dynamic expansion studies and the general theory of evaporation phenomena (with support of the Ispra services).

Improvements will take place in the new established laser surface heating technique and the introduced surface temperature measurement technique will be complemented by measurements on the emission spectra of the plasma jet, the gas dynamic expansion of which will be analysed on the basis of high-speed photography.

The complex gas phase, especially over ternary fuel systems, will be analysed by means of a time of flight mass spectrometer.

The work on fission products containing systems will be complemented by the investigation on pure fission products by means of a high temperature autoclave in co-operation with the University of Karlsruhe (and using the competence of Ispra in the field of heat pipe development).

Activities	1977	1978	1979	1980
<u>Materials Programme</u>				
Oxide Fuels (U,Pu)O <sub>2</sub> , UO <sub>2</sub>	▨			
Advanced Fuels (U,Pu)C, (U,Pu)N	▨	▨	▨	
Cladding Materials			▨	▨
Na-Coolant	▨	▨	▨	
Fission Products, Cs ...	▨	▨	▨	
<u>Advanced Techniques</u>				
Emission Spectroscopy		▨	▨	
p <sub>i</sub> : Mass Spectrometry (Fast Spectrum Recording)	▨	▨		
High Temperature Autoclave	▨	▨	▨	
<u>Theoretical Studies</u>				
Critical Data Assessment	▨	▨	▨	▨
Gas Dynamic Expansion Theory	▨	▨	▨	
Evaporation Phenomena	▨	▨		

As shown in this planning, the systems will be investigated one after the other (although reappraisals based on techniques improved in the meantime are not excluded). The theoretical studies as well as the technical improvements cannot, by their very nature, be defined sharply in advance.

MANPOWER AND COSTS

PROGRAMME : PLUTONIUM FUELS AND ACTINIDE RESEARCH				
PROJECT 1 : UTILIZATION LIMITS OF PLUTONIUM FUELS				
	1977	1978	1979	1980
RESEARCH STAFF	68	60	52	52
INVESTMENTS (K.U.A.)	190	110	100	100
RUNNING COSTS (K.U.A.)	350	300	250	200
CONTRACTS (K.U.A.)	500	400	200	200

Hypothesis A: Activity "Swelling of Advanced Fuels" continues after decision point end 1978

PROGRAMME : PLUTONIUM FUELS AND ACTINIDE RESEARCH				
PROJECT 1 : UTILIZATION LIMITS OF PLUTONIUM FUELS				
	1977	1978	1979	1980
RESEARCH STAFF	68	60	32	32
INVESTMENTS (K.U.A.)	190	110	50	50
RUNNING COSTS (K.U.A.)	350	300	150	100
CONTRACTS (K.U.A.)	500	400	50	50

Hypothesis B: Activity "Swelling of Advanced Fuels" discontinues after decision point end 1978

## 2. PROJECT: PLUTONIUM AND ACTINIDE ASPECTS OF THE SAFETY OF THE NUCLEAR FUEL CYCLE

### 2.1. BACKGROUND

The nuclear fuel cycle has to be viewed as a whole and thus, each of its elements should be considered according to such aspects as feasibility, economy and safety. Within the frame of this project, special aspects of the plutonium fuel cycle have been selected on the basis of their importance, the state of the art in the field, the general orientation for the next multiannual programme of the JRC, and on the basis of the special competences of the Karlsruhe JRC establishment which is supposed to execute the largest part of this programme.

The projects elements are the following:

- TACO. Measurement of integral cross-sections and fission yields in fast reactor neutron fluxes, with special emphasis on actinides and the more abundant fission products.
- FACT. This activity is an enlargement of TACO but treats the actinide formation in-pile more generally. The results are necessary for reactor physics calculations, for the determination of the burn-up and the chemical and isotopic composition of spent fuel (including recycled) and thus, have a bearing on reprocessing studies and on the evaluation of the composition of the radioactive wastes from different cycles.
- SHAPE. This activity covers essentially two aspects of the problem of the safe handling of plutonium compounds:
  - Because of their toxicity, the handling of these products is difficult. For several reasons, it is particularly indicated to work out and establish general procedures and rules in this field.
  - The reproducibility and uniformity of the products is absolutely necessary for a prediction of their in-pile behaviour and thus, for safety studies.
- RECARB. The study of specific aspects of the head-end treatment of carbide fuels is necessary for judging their potential both on the economic and the safety level.

### 2.2. TECHNICAL DESCRIPTION

#### 2.2.1. TACO: Determination of Integral Cross Sections and Fission Yields in Fast Reactors

- In order to optimize the energy production in fast reactors, actinide production and consumption must be determined as soon and as accurately as possible. Along with this, integral cross-sections and cumulative fission yields for the uranium cycle as well as the possible thorium cycle, must be measured. The results are relevant for safety analysis as well as waste handling and reprocessing.

In the frame of the research programme of the Community, there are no overlapping activities at the moment, be they existing or future (except for FACT), direct or indirect. Partially complementary work is



carried out by CEA. Similar tests are underway in the USA, the results of which (should they be published) should support those of this action.

#### Description of the activity

The goal of the programme is the determination of neutron capture and fission cross-sections in the fast neutron spectrum (RAPSODIE) for the Th-232 to Am-243 nuclides. The cumulative fission yields of every nuclide will be determined for the first time. The nuclides of the uranium cycle have been examined for the most part in the foregoing programme.

Control tests are still to be made. The capture cross-sections of the thorium cycle nuclides as well as of several fission products will be analysed in the next multiannual programme.

#### Planning

	1977	1978	1979	1980
Uranium cycle	■			
Thorium cycle			■	■
Fission products	■	■	■	
Cross sections	■	■	■	

#### 2.2.2. FACT: Formation of Actinides In-Pile

In Europe, plutonium is being increasingly fed into the nuclear fuel cycle. It will be used in thermal reactors and exclusively in fast reactors at a later date. The repeated use of Pu enhances the enrichment of the higher isotopes and favours the formation of the transplutonium nuclides. Because of their high toxicity and insufficiently known behaviour in the fuel during irradiation and handling, they have to be considered in the risk analysis for reactor operation, fuel reprocessing and waste disposal. Permanent contact with the Community Programme, "Nuclear Materials and Radioactive Waste Management", is ensured because specific points of this programme will also be dealt with by the same group of the Karlsruhe JRC establishment which is concerned with isotopic analysis and heavily involved in the FACT activity.

Integral cross-sections for the transuranium nuclides (up to Am-243) and pertinent to the RAPSODIE reactor, have been determined by the present programme, TACO. In addition, the corresponding cumulative fission product yields are being measured.

Differential cross-sections (e.g. Am-241) shall be determined within the frame of the present "Nuclear Materials' and Radioactive Waste Management" (direct action), and will continue to be measured during the next period within the frame of this and also the METRE programme.

Cross-sections of higher Pu isotopes will be determined, for the thermal recycling of Pu, in the corresponding programme of the indirect action. Post-irradiation isotope analyses on a limited scale are foreseen and will be carried out partially, upon request, at the Transuranium Institute.

The waste programme of the indirect action foresees a systems analysis for nuclear incineration. Extensive experimental studies of the transplutonium build-up in fast and thermal reactors are not planned. Major national actions, except for some systems analysis studies, similar to the indirect action, are not known.

Post-irradiation isotope analyses of Pu bearing fuels are being performed in collaboration with CEA (PHENIX reactor) and CNEN (GARIGLIANO reactor).

Differential cross-section measurements for transuranium isotopes in the thermal and epithermal energy range are being performed at ORNL. The need for integral cross-section measurements has been emphasized at a recent IAEA-OECD meeting (TND, Karlsruhe, Nov. 1975).

The aim of this activity is to analyse the actinides (mainly transplutonium isotopes) in the various reactor fuels in order to establish a better prognosis for the formation and behaviour of these nuclides in future reactor fuels.

#### Description of the Activity

- a) Measurements of integral cross sections according to the "TACO"-method, with special emphasis being placed on the Cm isotopes in fast reactors and higher transuranium isotopes in thermal reactors (in continuous co-operation with the indirect action: Pu-recycling) are to be undertaken.
- b) The formation and distribution of actinides in reactor fuels shall be analysed by post-irradiation isotope analysis of pellet samples and of samples from reprocessing input solutions which have the average concentration of those elements contained in the fuel.
- c) These results will serve as controls for burn-up calculations and will be used to study isotope correlations. The latter will enable a more precise prediction of transplutonium isotope formations in reactors than in the usual reactor calculation programmes (including extrapolations to higher burn-ups).
- d) The multiple use of Pu leads to an enrichment of higher isotopes which in turn influence reactor performance. Because of the non-availability of high Pu isotopes in sufficient quantities large enough to fabricate "simulated fuel pins", a recovery of Pu from an already irradiated Pu fuel element is proposed. This second generation Pu will be recovered in order to fabricate a new fuel element which in turn can be used for reactor studies. Experience in this field has been gained at the laboratory through the recovery of Pu from "scraps" of fuel fabrication.

Planning

FACT - Version A:(Activity 1.1. continued beyond 1978)

1977	1978	1979	1980
<p>Measurement of integral cross-section of Cm isotopes in fast reactors                      fabrication of irradiation analysis capsules</p>			
<p>Local distribution of transuranium isotopes in fuel elements                      post-irradiation isotope analysis</p>			
<p>Study of isotope correlations for trans-plutonium isotopes in various reactors</p>			
<p>Comparison of the prognosis capabilities of correlations, post-irradiation analysis and burn-up calculations.</p>			
<p>Construction of an installation in the hot cell</p>		<p>Recovery of 2nd generation Pu</p>	<p>Fabrication of a fuel element with 2nd generation Pu</p>

FACT - Version B: (Activity 1.1 stopped at the end of 1978)

1977	1978	1979	1980
<p>Measurement of integral cross-section of Cm- isotopes in fast reactors fabrication of capsules</p>			
		irradiation	analysis
<p>Measurement of integral cross-sections of transuranium isotopes in thermal reactors fabrication of capsules</p>			
		irradiation	analysis
<p>Local distribution of transuranium isotopes in fuel elements post-irradiation isotope analysis</p>			
<p>Study of isotope correlations for transplutonium isotopes in various reactors</p>			
<p>Comparison of the prognosis capabilities of correlations, post-irradiation analysis and burn-up calculations</p>			
Construction of an installation in the hot cell		Recovery of 2nd generation Pu	Fabrication of a fuel element with 2nd generation Pu

### 2.2.3. SHAPE: Safe Handling of Plutonium Compounds

Plutonium as an extremely (radio) toxic material needs special handling precautions. As it will be recycled after use in thermal or fast reactors, its isotopic composition will change and the protection measures for its manipulation will have to increase considerably. Therefore, the establishment of procedures and general rules for safe handling of Pu containing materials in considerable amounts is necessary. The safety problems during handling of plutonium compounds depend essentially on the aerosols formed. A systematic study of their formation, properties and stability, as function of the handled compounds, their physical form and their environment is essential for the acceptability of Pu fuels in nuclear energy.

In addition, the standardization of fabrication procedures and techniques is useful to obtain reproducible and uniform products which meet the standards of reactor safety. A detailed study for advanced fuels is therefore suggested.

Finally, investigations of the above type will facilitate the elaboration of uniform safety standards.

Practical experience of dosimetry and shielding of recycled Pu is still limited. Calculations of radiation doses for executing staff have been made and should be verified, any practical experience being very scarce.

Though all laboratories involved in Pu work perform control measurements of Pu in the laboratory atmosphere, and though at some places (Fontenay, Harwell, Winfrith, Hanford, etc.) particle size measurements are being made, no systematic research on the properties of aerosols formed during the fabrication of Pu containing reactor fuels has been published.

The production of advanced Pu containing fuel is at present a laboratory process with many parameters that are not yet precisely known. The knowledge obtained so far is insufficient to define a standardization of pellet production and uniformity of the product.

#### Description of the Activity

- a) The build-up of plutonium and transplutonium elements changes the  $\gamma$  and n radiation properties and has to be followed in order to design a proper biological shielding. Protection problems have to be studied, as well as those of measurement of doses. The following activities are proposed:

- studying effective shielding and testing of neutron dosimetry. In this context use is made of the well established competence of the shielding group at the JRC Ispra.
  - measuring Pu-241 in Pu radiometrically because of its importance for cases of incorporation of recycled Pu.
- b) During the manipulation of plutonium, aerosols are formed, which actually constitute the main parts of contamination and the main preoccupation as far as the health hazards of plutonium are concerned. Such aerosols have so far been studied mainly as a Pu contamination in laboratory air. The emphasis of the suggested activity will be put on the study of Pu aerosols in glove boxes, and the investigation will treat both the formation and the properties of aerosols occurring during normal manipulation as well as under exceptional conditions, e.g. carbide fires.

In detail, the following points will be investigated:

Particle size distribution, stability of the particles, interaction (adhesion) with surfaces of aerosols in different atmospheres, with special emphasis on Pu carbide aerosols.

Improving sampling techniques.

Scanning microscopic studies of Pu containing particles.

Production of possibly mono-disperse aerosols.

- c) Reproducibility in preparation of well-characterized advanced fuels:

It is suggested to study:

- Kinetics of the carbothermic reduction for the preparation of advanced fuels: determination of the reduction rate as a function of parameters such as temperature, partial gas pressures, reaction surface
- Determination of equilibrium pressures, composition of the products and depletion in plutonium by gas transport. Monitoring of volatile reaction products (CO, CO<sub>2</sub>, N<sub>2</sub>), using I.R. absorption cells and gaschromatography: combining these parameters with the chemical composition of the end product to evaluate the reaction mechanism
- Sintering of advanced fuel with special emphasis on Pu losses
  - Influence of particle size, temperature and atmosphere on the densification process during sintering (Dilatometer studies): comparing the results with results from diffusion and inter-diffusion experiments.
- The Sol-Gel process

This process is especially useful for the production of vibro-

compacted fuel. The parameters which determine the chemical composition will be studied as well as the factors influencing the density and the structure of the particles.

### Planning

	1977	1978	1979	1980
Handling recycled Pu		Comparison of handling methods		Assessment of approved meth.
Aerosols		Devel. of sampl. techniques	scanning electron microscope	assessment of results
Advanced fuels		Sintering and carbotherm. reduction studies	sol-gel carbide optimized	data eval.; suggestion of prod. methods

(The extent of activities after 1978 depends on the attribution of potential).

#### 2.2.4. RECARB: Some Aspects of the Head-end Processing of Carbide Reactor Fuel

Mixed uranium-plutonium carbide is considered a potential fuel for advanced fast breeder reactors. In the fuel elements, carbide pellets will be bonded for heat transfer with helium or sodium to stainless steel cladding.

Because of expected difficulties and costs of preparing and handling such fuel on an industrial scale, fuel fabricators do not yet agree on the necessity of fabricating carbide fuel for breeder reactors. The reprocessing industry is even less interested in dealing with advanced fuel at this moment, as it is busy coping with the problems arising from the processing of high burn-up LWR fuel.

The possible advantages of carbide over oxide fuel are expected to lead to increasing use of the former around the year 1990. Then, the reprocessing industry should be prepared to process advanced fuel as well.

Although a number of non-aqueous reprocessing methods for fast reactor fuel has been suggested in the past, the experience gathered until now in pilot plants, and the difficulties with new processing concepts will probably prevent the use of any method other than solvent extraction by TBP. TBP extraction is accepted world-wide and represents the basis of all larger scale reprocessing plants under construction. Future reactor fuel, irrespective of the reactor (LWR, HTGR, FBR) or the fuel type (oxide, carbide,) is expected to be reprocessed by TBP extraction after preparation of nitric acid feed solution in a corresponding head-end process.

A head-end process for carbide fuel would involve:

- a) storage after irradiation
- b) decladding and/or chopping of the fuel
- c) removal of the alkali metal (possibly)
- d) pyrohydrolysis, burning and/or nitric acid dissolution of the oxide ash or of the fuel
- e) adjustment of the nitric acid solution to feed specifications.

Until now there are only a limited number of preliminary studies on a laboratory scale; studies with plutonium containing carbides, in particular after irradiation, are scarce. There is especially lack of knowledge on problems such as:

- storage of fuel
- presence of alkali metal
- corrosion or oxidation of fuel (irradiated and not) in different atmospheres
- reaction of carbides (irradiated) with processing agents.

Competence in preparing, handling and investigating plutonium containing carbide fuel enables the Karlsruhe establishment of the JRC to furnish solutions to some of these future problems which industry is not yet ready to attack.

Although there are no direct or indirect actions in carbide breeder fuel reprocessing, there are a few investigations (within and outside the Community) related to the problem:

- the corrosion behaviour of uranium and thorium carbides was studied at Grenoble (Centre d'Etudes Nucléaires)
- the off-gas evolution during carbide dissolution is being studied at Mol (Centre d'Etudes Nucléaires)
- the combustion of graphite clad fuel is being studied at Jülich (Institut für Chemische Technologie) and at Oak Ridge National Laboratory (Chemical Technology Division).

#### Description of the Activity

The work suggested will be restricted to fast reactor fuel: (predominantly) sodium-bonded, plutonium containing carbide pellets, clad in stainless steel.

Carbide fuel is known to react vigorously with components of air; therefore inert atmosphere is required for fabrication, handling and storage. The removal of alkali metal coolant has been neglected in former proposals for head-end processes of carbide fuel.

Controlled oxidation of carbide fuel, an apparently simple approach, requires decladding and may cause problems of criticality control if carried out at an industrial scale. Direct dissolution of carbide in nitric acid is difficult to control and will prevent tritium from being easily removed; in addition, direct dissolution is known to lead to the formation of organic acids that influence the kinetics and thermodynamics of solvent extraction.



The proposed investigations aim at the solution of selected problems related to potential head-end processes. They emphasize oxidation of unirradiated and irradiated fuel at storage and at combustion temperature (controlled oxidation), and the direct dissolution of carbide.

a) Basic aspects of carbide fuel oxidation and dissolution

The investigations involve the determination of the rates of reaction in mixtures of inert gas, oxygen and water vapour, and the characterization of the reaction products by chemical, crystallographic and ceramographic analysis. Methods for eliminating organic compounds formed during dissolution of carbide in nitric acid must be developed.

These studies can be performed with gramme quantities of plutonium carbide and mixed uranium-plutonium carbide (unirradiated and irradiated).

b) Development of combustion and dissolution methods

Depending on the results of the basic oxidation and dissolution studies, scouting experiments for a head-end process of irradiated fuel should be scaled up to more realistic batch sizes (~100 g). Different techniques of combustion (rotary kiln, fluidized bed ...) and of dissolution will have to be compared. The (possible) removal of alkali metal has to be considered.

c) Head-end process test

A final proposal of a head-end process will be tested with an irradiated carbide fuel pin.

Planning

	1976	1977	1978	1979	1980
Basic investigations		Storage, controlled oxidation, dissolution of unirradiated carbide compact samples, powders, pellets	Storage, controlled oxidation, dissolution of irradiated fuel, powder, pellets		
Development of methods		Comparison of combustion and dissolution methods	Removal of alkali metals		
Test					Head-end process test with irradiated fuel pin

MANPOWER AND COSTS

PROGRAMME : PLUTONIUM FUELS AND ACTINIDE RESEARCH				
PROJECT 2 : PLUTONIUM AND ACTINIDE ASPECTS OF THE SAFETY OF THE NUCLEAR FUEL CYCLE				
	1977	1978	1979	1980
RESEARCH STAFF	24	32	40	40
INVESTMENTS (K.U.A.)	120	230	130	120
RUNNING COSTS (K.U.A.)	110	220	230	340
CONTRACTS (K.U.A.)	120	240	230	110

Hypothesis A: Activity "Swelling of Advanced Fuels" continues after decision point end 1978

PROGRAMME : PLUTONIUM FUELS AND ACTINIDE RESEARCH				
PROJECT 2 : PLUTONIUM AND ACTINIDE ASPECTS OF THE SAFETY OF THE NUCLEAR FUEL CYCLE				
	1977	1978	1979	1980
RESEARCH STAFF	24	32	60	60
INVESTMENTS (K.U.A.)	120	230	230	120
RUNNING COSTS (K.U.A.)	110	220	390	380
CONTRACTS (K.U.A.)	120	240	380	260

Hypothesis B: Activity "Swelling of Advanced Fuels" discontinues after decision point end 1978

### 3. PROJECT: ACTINIDE RESEARCH

#### 3.1. BACKGROUND

Within the Community, the Karlsruhe JRC establishment: European Institute for Transuranium Elements, is playing a central role in the field of actinide research. In addition to its own experimental and theoretical contributions to the understanding of bonding in actinides, this Institute has established contacts between specialists and research groups with interest in this field of research, and is co-ordinating an increasing number of co-operative research work.

Favoring these co-ordinated efforts, scientists with divergent expertise working in the various laboratories of the Community meet 1 to 2 times per year on the occasion of the "Journée d'actinides" to present and discuss ideas in the solid state chemistry, physical chemistry and physics of the actinides. In addition, there is an informal agreement between specialists in the field upon a regular exchange of information about actual research work and of publication lists of the different groups working in Europe and in the United States. The Institute collates and distributes such information in western and central Europe and acts as European correspondent to the US counterpart at Argonne National Laboratory. The Institute organized, in September 1975 at Baden-Baden the 5th International Conference on Plutonium and Other Actinides and the 4th International Transplutonium Element Symposium.

In the field of actinide research, there is increasing interest in the understanding of chemical bonding in actinide solids. The nature of bonding in actinides, the heaviest elements available for solid state studies, can be derived from the detailed investigation of particular chemical and physical properties. Such investigations depend on the availability of well-characterised samples, and require the co-operation of many experimentalists and theorists. Only a limited number of specialized laboratories are equipped to contribute to the solution of problems of actinide research, and particularly advanced theory is required to interpret the results.

The actinide research carried out in the frame of the current programme of the Institute is the only direct action in this field. There is no indirect action within the Community.

This research is carried out in two stages: preparation and characterisation of actinide samples performed (almost entirely) at the laboratory and investigation of the properties of actinides. The latter is performed (partially) in collaboration with specialized laboratories within the Community that have established expertise in actinide or actinide-related areas, e.g.:

- Laboratoire de Radiochimie, Université de Liège, Belgium
- Département de Recherche Fondamentale, CEN, Grenoble, France
- Département de Génie Radioactif, CEN, Fontenay-aux-Roses, France
- Chemistry Division, A.E.R.E. Harwell, Great Britain,
- Institut für Heiße Chemie, GfK, Karlsruhe, Federal Republic of Germany.

The collaboration is based on personal contacts as well as on contracts that define the objectives and costs of the studies involved. Some of

the investigations are supported by grants from the Commission to encourage Ph.D. dissertations in the field of actinide solids. In other cases, staff members of foreign institutions participate in actinide research during temporary attachment to the laboratory.

Examples of the more important co-operative activities:

- Thermodynamics of actinide metals (Liège, continuing),
- Magnetic structure of actinide metals and compounds (Grenoble, continuing)
- Specific heat measurements of actinide metals and compounds (Harwell, continuing),
- Structure, magnetic, Mößbauer studies on actinide systems (Fontenay, Karlsruhe, Strasbourg).

### 3.2. TECHNICAL DESCRIPTION

Actinides are transition elements characterized by the presence of an unfilled inner shell of 5f-electrons. Whereas 4f-electrons in lanthanide elements are localized about the atomic nucleus and participate only slightly in chemical bonding in the solid state, there is evidence that 5f-electrons are delocalized and participate in the bonding of actinide solids.

Actinides form a particular group of elements with marked differences between the first and second half of the series. Interest is concentrating on the least investigated elements in the first half of the series. Special attention is being given to the study of protactinium (Pa), americium (Am), and curium (Cm) metals and compounds. Pa is expected to be the first element with 5f-electron hybridization and participation in bonding. The 5f-electrons in Am and Cm, on the other hand, are assumed to be localized about the actinide nucleus; that would explain a certain similarity between these elements and their lanthanide homologues.

Information on the strength and nature of chemical bonding in actinides, in particular the extent of 5f-electron participation, can be obtained from an investigation of the structure, of the thermodynamics, or of electronic (electrical, magnetic, optical) properties of the solids. In most of these investigations, the development of bonding models is required for an unambiguous interpretation of the experimental results. However, photoelectron emission is expected to yield electron configuration and bond energies directly. Therefore, a major part of the future programme will involve spectroscopic studies.

The future programme is a logical continuation of the present activity and will be realized in a similar way:

#### 3.2.1. Preparation and Characterization

Samples of the (rare and highly reactive) metals Pa, Am and Cm, and of their compounds will be prepared (partially by innovative methods) and characterized by chemical, metallographic and crystallographic analysis. Binary systems with noble metals, oxygen, hydrogen, carbon or nitrogen are of particular interest. Single crystals of both metal and compound are required for the study of anisotropy.

### 3.2.2. Investigation of Properties

#### Phase stability and structure

The structure and stability of a crystal depend primarily on the valence and on the electron structure of its constituents. In the case of actinide metals, the valence can be determined from the ZACHARIASEN relationship between valence and metallic radius. Recently, the electron configuration could be correlated to crystal structure by an extrapolation of the BREWER-ENGEL theory to heavy elements. Phase transitions as a function of temperature or pressure can be accompanied by changes of the radius and the crystal structure, hence by a change of valence and electronic configuration.

For the first half of the actinide series, the crystal structures stable at room temperatures are known. There are doubts about the high temperature forms of Pa, Am and Cm metals. The low temperature modifications are unknown. The pressure dependence reflects the relationship between interatomic distance and electron configuration.

The temperature dependence of crystal structures and lattice parameters of metals and compounds will be determined by X-ray or neutron diffraction. X-ray diffraction will also be used to measure the pressure dependence of lattice structure and parameters.

Neutron diffraction studies are particularly interesting in the case of actinide hydrides: these compounds are ionic and their fluorite lattice can be defective. Their investigation may furnish information applicable to models of oxide defect structures. Neutron diffraction will be performed in co-operation with CENG and ILL (Institut v. Laue-Langevin), Grenoble, using JRC personnel attached to ILL.

#### Thermodynamics

Modern approaches to the understanding of bonding in 5f-elements have been based on correlations between thermodynamic function of phase transitions and electron configurations in both phases. Where-as reliable correlation functions could be established for elements of constant valence (4f-lanthanides), such correlations are more complex and difficult for elements of varying valence, which, like the first members of the actinide series, display varying f-participation in the bonding.

Thermodynamic parameters necessary for such correlations are e.g. the enthalpy of sublimation and the enthalpy of formation, specific heat and entropy values of elements and compounds. The enthalpy of formation of ions and of compounds can be determined by the measurement of the heat of dissolution of metals and compounds. In co-operation with the University of Liège, the determination of the heats of dissolution of actinide metals will be continued with Pa, and that of the binary compounds will start shortly.

#### Specific heat at low temperature

Specific heat measurements at low temperature allow the isolation of the electronic contribution to heat content: information is ob-

tained on electron occupancy at the Fermi level. Solid state transitions (phase transitions, magnetic transitions) are reflected in the dependence of the heat content on temperature. Therefore, specific heat measurements furnish a link between thermodynamics and electronic properties of a solid. In co-operation with A.E.R.E. Harwell, the specific heat measurements on metals will be continued, those on oxides will be extended to other binary compounds.

#### Electronic Properties (Electrical Resistivity, Magnetic Susceptibility and Ordering)

The temperature dependence of electrical resistivity provides information on the basic electron scattering mechanisms. At low temperature, the details of electronic interactions, responsible for the scattering processes, and their depending on the quantum character of interacting electrons and on their magnetic properties are revealed.

Measurements of the resistivity of thin metal (Am, Cm) films performed up until now, must be extended to bulk material and possibly to single crystals. Special attention will be paid to the investigation of Pa, where superconductivity is expected. The low temperature properties of Pa will be investigated in close co-operation with A.E.R.E. Harwell, the metal samples being prepared at the Institute from protactinium oxide made available on loan from Harwell.

Electron configuration and spin orientation are reflected in the magnetic susceptibility of the actinide solids. Most of the light actinide metals show temperature independent paramagnetism. Curium has recently been observed to order antiferromagnetically around 52 K, some curium compounds are ferromagnetic. Besides continuing the susceptibility measurements of Pa metal and actinide compounds, it is intended to elucidate the nature of the paramagnetism and the magnetic ordering. Therefore the co-operation with the scientists of the CENG will be complemented by neutron diffraction work at ILL, again supported by JRC personnel attached to the Grenoble establishment.

#### Electronic Properties (Spectroscopy: Photoelectron Emission, Optical)

The development of bonding models requires a more detailed knowledge than that obtainable from previously described experiments. Theoretical studies (also being performed in this Laboratory) use especially spectroscopic information to develop quantitative models of the electronic structure.

In this Laboratory, optical spectroscopy (in a wide spectral range) is being applied to the study of actinide oxides and metals. It provides information on the lattice dynamics (far infrared) as well as on the behaviour and scattering mechanisms of conduction electrons (intraband transitions). In the vacuum ultraviolet region, information is gained on the combined density of states of occupied and unoccupied bands of solids (interband transitions).

Photoelectron emission spectroscopy (XPS/UPS), a modern and still developing technique, complements optical spectroscopy and yields even more insight into the electronic structure. (XPS = excitation by X-radiation; UPS = excitation by UV radiation).

Especially by using different frequencies of excitation, information is obtained essentially on:

- the density of states of valence bands in solids; hence, on the energies of electronic states involved in chemical bonding
- the orbital character of photoemitted electrons, hence on the degree of participation of different orbital states in the formation of valence bands (quantum character).

The development of photoemission spectroscopy for actinide research is the aim of a co-operative effort with scientists of CENG.

### 3.3. PLANNING

In the following time-table only the most important points of the research programme are listed. Preparation and characterisation, except those of single crystals are omitted; the samples of (mostly short-lived) radioisotopes, in general, cannot be stored; they must be prepared immediately prior to their investigation.

	1976	1977	1978	1979	1980
Phase Stability and Structure	Single crystals (metals)		Single crystals (compounds)		
	Temperature and pressure dependence of crystal structures metals		Temperature and pressure dependence of crystal structures compounds		
Thermodynamics	Heat of dissolution metal phases		Heat of dissolution compounds		
	Specific heat metals		Specific heat compounds		
Electronic Properties	Resistivity metals				
	Magnetic susceptibility and ordering metals		Magnetic susceptibility and ordering compounds		
Photoelectron Emission (UPS/XPS)	Basic equipment performance tests		Electron configuration compounds metals		

MANPOWER AND COSTS

PROGRAMME : PLUTONIUM FUELS AND ACTINIDE RESEARCH				
PROJECT 3 : ACTINIDE RESEARCH				
	1977	1978	1979	1980
RESEARCH STAFF	29	29	29	29
INVESTMENTS (K.U.A.)	100	150	100	50
RUNNING COSTS (K.U.A.)	150	150	150	150
CONTRACTS (K.U.A.)	125	125	125	125



ADVISORY COMMITTEE  
ON PROGRAMME MANAGEMENT-----  
"PLUTONIUM AND TRANSPLUTONIUM ELEMENTS""OPINION"

The Committee has taken note of the programme proposal "Plutonium Fuels and Actinide Research 1977-1980" (TU 23/75) and on demand of the CCG has prepared the following statement, which was adopted during the meeting of November 25 and 26, 1975:

1. The present programme - as executed at the European Institute for Transuranium Elements - will partially remain of immediate interest during the next period.
2. The Committee agrees on the progressive introduction of the new activities as shown in the Technical Annex.
3. From the scientific point of view, the Committee estimates that the European Institute for Transuranium Elements could call upon the cooperation of the other JRC establishments.
4. The Committee would appreciate the possibility of revising the programme "Plutonium Fuels and Actinide Research" twice during the next period in order to confirm or modify its orientation, respecting the frame fixed by the decision of the Council.

ADVISORY COMMITTEE  
ON PROGRAMME MANAGEMENT

-----  
"PLUTONIUM AND TRANSPLUTONIUM ELEMENTS"

Technical Annex to the Programme Opinion

Current Activities

1. The project "Swelling of Advanced Fuels" should continue, with the present potential to begin with. It should keep its character of basic research useful for technological necessities. It will be re-considered in extent (apart from continuous monitoring) around the beginning of the next plan.
2. The project "Compatibility Oxide/Steel" should be brought to an end around the middle of the next plan. This refers as well to the re- search on the basic machanisms as to the identification of the practi- cally relevant parameters.
3. Basic research on actinides in general should continue with about the present effort in enforcing the important role of the Transuranium Institute in European actinide research, amongst others, by fully utilizing the newly installed equipment of electron emission spec- troscopy.
4. The operation TRESON should, within the near future, arrive at a result with regard to the development and testing of the device.
5. The operation "Equation of State of Nuclear Materials" should go on as before, its efficiency and relevance should be continuously monitored, also with regard to the necessary investment.
6. The operation TACO should continue until it leads to conclusions with regard to the present problems.
7. Work upon request should proceed as before within the frame of the possibilities.

Candidate Activities

8. A programme to study the build-up of higher actinides in the nuclear fuel cycle ought to be formulated to replace the proposed operation "Actinide Transmutation". This programme should start at the beginning of the plan.

9. The operation "Safe Handling of Plutonium Products" ought to focus on aspects of safety, characterization, reproducibility and standardization of procedures and ought also to start in 1977.
10. The operation "In-Pile Thermal Behaviour of Fuels - Thermophysical Measurements" ought to include the promotion of the device TRESON and the method TREGAP. The utilization of the TRESON and TREGAP devices for the scientific programme of the Institute will be discussed by the Committee, when the working conditions of these devices have been established.

Remarks

11. The possible application of the TRESON device for reactor safety research as well as thermal measurements on molten phases (presumably in a similar context) will have to be discussed.
12. The operation "Extreme Temperature Chemistry" has not been discussed because it does not enter significantly into the time schedule of the next programme.
13. The Committee discussed the opportunity to start a moderate activity (mini-project) on plutonium fuel head end reprocessing, but needs further deliberation before taking a final decision.
14. If it is necessary to free additional potential to start new activities, the Committee proposes to consider first a reduction in the extent of projects 1 and 2.
15. The Italian delegation expressed no interest in basic research of actinides (cf. 3.).
16. Finally, the Committee recommend that the laboratory keeps or even increases its contacts with others EEC indirect actions carried out in its field of competence.

**3. NUCLEAR MATERIALS AND RADIOACTIVE WASTE MANAGEMENT**

PROGRAMME:

NUCLEAR MATERIALS AND RADIOACTIVE WASTE MANAGEMENT

T A B L E O F C O N T E N T S

INTRODUCTION

1. PROJECT: THE EVALUATION OF THE LONG-TERM HAZARD OF RADIOACTIVE WASTE DISPOSAL

1.1. BACKGROUND

1.2. TECHNICAL DESCRIPTION

1.2.1. Waste Hazard Analysis

1.2.2. Long-term Stability of Conditioned Waste

1.2.2.1. High Activity Waste

1.2.2.2. Alpha-contaminated Waste

1.2.3. Interactions of Actinides with the Environment

1.2.4. Actinides Monitoring

1.3. PLANNING

1.4. MANPOWER AND COSTS

1.5. CONTRACTS

1.6. REFERENCES

2. PROJECT: CHEMICAL SEPARATION AND NUCLEAR TRANSMUTATION OF ACTINIDES

2.1. BACKGROUND

2.2. TECHNICAL DESCRIPTION

2.2.1. Chemical separation of actinides

2.2.2. Assessment studies on/and nuclear data for actinides transmutation

2.2.3. Cross section measurements

2.3. PLANNING

2.4. MANPOWER AND COSTS

2.5. REFERENCES

### 3. PROJECT: FUEL MATERIALS MANAGEMENT

#### 3.1 BACKGROUND

#### 3.2 TECHNICAL DESCRIPTION

##### 3.2.1 Bench Mark Experiments

###### 3.2.1.1. Experimental Post irradiation Analysis

###### 3.2.1.2. Elaboration of experimental data

##### 3.2.2. Isotope Correlation Studies

###### 3.2.2.1. Experimental work on isotope correlations

###### 3.2.2.2. Theoretical Analysis

###### 3.2.2.3. Operation of the data bank

##### 3.2.3. Non destructive Analysis (N. D. A.)

###### 3.2.3.1. Development and Practical Applications of N. D. A. techniques

###### 3.2.3.2. Standardization of non-destructive techniques

#### 3.3 PLANNING

#### 3.4. MANPOWER AND COSTS

### 4. PROJECT: STUDIES FOR DECONTAMINATION OF REACTOR COMPONENTS

#### 4.1. BACKGROUND

#### 4.2. TECHNICAL DESCRIPTION

##### 4.2.1. Contamination Mechanisms in High Temperature Water Circuits

##### 4.2.2. Nature of Contaminated Surface Layers

##### 4.2.3. Mechanisms of Action of Decontaminants on Surface Layers

##### 4.2.4. Depth of Attack by Decontaminants on Coupled Alloys of different Composition

##### 4.2.5. Depth of Surface Attack after Repeated Contamination - Decontamination Cycles

#### 4.3. MANPOWER AND COSTS

## APPENDIX E-I-03

## PROGRAMME

NUCLEAR MATERIALS AND  
RADIOACTIVE WASTE MANAGEMENTINTRODUCTION

The research proposed under this heading is an attempt to find convincing answers to two major questions frequently posed by the general public to advocates of nuclear power :

- a) Will future generations have to pay for the benefits we get now from nuclear power?
- b) Can it be guaranteed that the nuclear materials used and generated by nuclear power are safely contained within the fuel cycle?

To find a convincing answer to the first question is a rather challenging problem, particularly when we think that by "future generation" we mean people who will live on this planet for the next 100,000 years.

We propose to attempt to find two different answers to the question:

- a) To prove, by a rigorous analysis, that permanent disposal of nuclear waste in well chosen geological sites does include all safety features required to ensure that future generations will not be harmed.  
This is the objective of Project I (The evaluation of the long-term hazard of radioactive waste).  
Such an evaluation demands both scientific rigour and a good deal of imagination in foreseeing all possible failure modes of waste containment.  
We plan to deal with the problem by a well defined approach, (the barrier approach) which requires a balanced effort of

theoretical and experimental studies. This approach arose from reactor safety studies and is already under development for waste disposal in the present programme.

- b) To try to find an alternative waste management scheme by which the elements responsible for long-term hazard (long-lived emitters) are kept within the fuel cycle, and not included in the waste.

This is the objective of Project II (Chemical separation and nuclear transmutation of actinides).

This approach is certainly appealing as an ultimate solution, but the technical problems involved are indeed many and an advanced nuclear technology is required for their solution. The approach must therefore be studied with great care because there is a definite danger that the cost of development may be prohibitively high, or even that more problems are created than solved.

A partial solution of the problem (chemical separation and separate management of actinides) may already be, however, an important step forward.

A convincing answer to the second question (Can it be guaranteed that nuclear materials are safely contained within the fuel cycle?) may be found only in a careful and meticulous control of the material flow. The burden of this control may be a rather heavy one for the nuclear industry, and the objective of Project III (Fuel materials management) is the development of techniques and methods which can make the control easier and safer.

The objective of Project IV (Studies for decontamination of reactor components) is to develop techniques required to solve the problems resulting from the accumulation of radioactive corrosion products in various circuit components of water cooled reactors.

The results obtained in the framework of Project IV could be utilized in the future also to solve problems of nuclear plant decommissioning which will constitute in the next decades a considerable part of the radioactive waste management problems.

The importance of the problems indicated in such that it is not surprising that they have been studied elsewhere by outstanding laboratories for many years.

As a general motivation for work at the JRC we may say the following:

- The difficulty of answering the first question is such that parallel and well co-ordinated efforts, by various teams which work with different approaches and different techniques, are advisable and even necessary.
- The "convincing power" of a JRC research towards the public may perhaps be higher than that of a national institute involved in developing and supporting nuclear power.

A satisfactory and timely execution of proposed projects demands a well balanced theoretical and experimental effort.

Theoretical model studies will provide the necessary frame and priorities for the experimental activities of Project I and II. The research tasks of these projects should be considered as "subroutines" of the main programme, and not as endless and self-sustaining activities.



Radiochemical studies will be the important "hardware" of project II and IV. The separation of actinides from high activity waste demands chemical laboratory experimentation on waste solutions ranging in radioactivity from "cold", simulated solutions to actual samples of highly active waste, to be handled in the medium level hot cells of the Ispra Centre.

Also the studies for decontamination of reactor components require radiochemical work on active materials.

Physico-chemical studies will try to answer all questions pertinent to long-term chemical and physical stability of conditioned waste in project I. The simulation of the effects of decay times exceeding 10,000 years will be a particularly challenging problem. Physico-chemical studies will also be required in the study of contamination and decontamination mechanisms (Project IV).

Development, testing and standardization of non destructive radio-analytical instrumentation is an important part of project I and III. This development will take advantage of the existing competences of the JRC.

Nuclear physics activities will answer all questions on the evolution of actinides in the fuel during irradiation and decay and on the feasibility of actinide recycling in various reactor types from a neutron physics point of view. They will also be applied to ameliorate the knowledge of nuclear data which are necessary for evaluating the recycling feasibility.

Environmental studies, finally, will be an important part of project I, and they will try to follow the environmental effects of possible loss of containment of stored waste and the time - and - environment dependent evolution of actinides.

All of these studies will take advantage of the existing scientific infrastructure of the JRC, and no major new installation will be needed. Competence in all the mentioned fields already exists and teams dealing with most of the mentioned subjects are already working in the frame of the 1973 - 1976 programme.

There are therefore all premises for a ready start towards the solution of problems which, if not tackled in time, may considerably slow down the development of the nuclear power industry.

SUMMARY OF MANPOWER AND COSTS

PROGRAMME - NUCLEAR MATERIALS AND RADIOACTIVE WASTE MANAGEMENT

	Research Staff (per year)	Investments (M. U. A.)	Total running expenditures (M. U. A.)	Resources (M. U. A.)	Required budget (M. U. A.)	Expected income (M. U. A.)
<u>PROJECT 1</u> Evaluation of long-term hazard of radioactive waste disposal	29	0.120	1.280	-	1.400	-
<u>PROJECT 2</u> Chemical separation and nuclear transmutation of actinides	25	0.120	1.320	-	1.440	-
<u>PROJECT 3</u> Fuel materials management	33	0.120	1.200	-	1.320	-
<u>PROJECT 4</u> Studies for decontamination of reactor components	10	0.040	0.160	-	0.200	-
TOTALS	97	0.400	3.960	-	4.360	-

# 1. PROJECT: THE EVALUATION OF THE LONG-TERM HAZARD OF RADIOACTIVE WASTE DISPOSAL

## 1.1. BACKGROUND

In this project a few studies initiated during the 1973-1976 programme are being continued and integrated with new activities in order to obtain a comprehensive view of waste hazard and of the quantitative value of the system of barriers which can be placed between waste and man.

In order to meet the objective, the work has been organized into four studies.

One is theoretical, and provides the necessary input-output links with the experimental activities carried out both inside and outside the JRC.

The remaining three studies are experimental. They aim to determine as accurately as possible the value of the various barriers and the resulting distribution pattern of actinides in nature.

The existing links with other activities of the Commission have been emphasized. A large amount of information obtained under the indirect programme on waste management and under the Radiobiology programme will in fact be of direct interest to this project. Conversely, this project can provide the Radiobiology programme with much information so that a part of their activities can be orientated towards the problems arising from the modern waste management schemes.

The exploitation of nuclear energy at an industrial level leads to the production of large quantities of radioactive wastes which are quite different in chemical composition, physical constitution, quantity and radio-activity. The waste can be grouped in three families:

- Activation Products,
- Fission Products,
- Transuranium Elements or Actinides (isotopes of Np, Pu, Am and Cm).

The activation products, mainly consisting of isotopes of chromium, iron, nickel and cobalt, have half-lives of less than a few years; their potential hazard is at all times relatively small, compared to that of the other two groups. The fission products represent, for the first few centuries, the greatest potential hazard, but the half-lives of all the important ones are less than thirty years, so that their activity will decrease to a quite negligible value within approximately five hundred years. There are a few fission products with very long half-lives; among these, only Tc<sup>99</sup> and I<sup>129</sup> may be of some concern, their activities are, however, orders of magnitude lower than the Actinides.

The latter are in fact the most important when the long-term hazard is taken into account, because they couple extremely long half-lives (up to millions of years) with very high radiological toxicity; the latter is due to the high biological efficiency of alpha-particles, to the pronounced tropism of most Actinides for important organs of the human

body, and to their very long biological half-life in the organs (e.g. 200 years for Plutonium in bone tissue). In addition, their daughters are also alpha-emitters and exhibit the same features.

It is worth noting that the present technology can certainly assure the containment of activation products in man-made structures.

The few centuries needed for the decay of fission products already require a high degree of international co-operation if the same engineered storage techniques are to be used. This same concept cannot be applied to the containment of actinides for periods of the order of hundreds of thousands of years, therefore, no safe alternative seems to exist to the development of permanent disposal techniques.

In order to give an idea of the magnitude of the problem, for an installed electro-nuclear capacity of 550-770 GW(e) by the year 2000 in the European Community, the annual quantity of waste to be disposed of corresponds, by assuming modern conditioning techniques, to 1300-1800 m<sup>3</sup> of vitrified high activity waste, containing 11-15 tons of transuranium elements, while the volume of alpha-contaminated low-level waste will be 90,000-126,000 m<sup>3</sup>; the total quantity disposed of by that time will be about ten times higher.

Many alternative concepts for the ultimate disposal of solidified radioactive wastes are being evaluated in most of the industrialized countries. They include geologic, seabed, ice sheet and extraterrestrial disposal, as well as nuclear transmutation (1,2,7). Each of these concepts splits up in to a number of secondary alternatives, as shown in the following table:

<u>Elimination</u>	<u>Earth Disposal</u>
Transmutation	Geologic Formations
Accelerator	Mined Cavity
Fission Reactor	Nuclear Cavity
Controlled Thermo-nuclear Reactor	Deep Hole
Extraterrestrial	Drilled Hole Matrix
Solar Impact	Manmade Structures in Geological Formations
Orbiting	Seabed
Solar Escape to Deep Space	Rapid Sedimentation Burial
	Deep Trenches
	Tectonic Subsidence Areas
	Stable Deep Sea Floor
	Ice Sheet
	Ice Burial - Free Flow
	Ice Burial - Anchored
	Ice Surface Facility

For each waste disposal alternative, a series of evaluation factors should be considered, such as:

- Technical feasibility,
- Safety,
- Costs,
- Environmental Impact,
- R & D Needs,
- Public Acceptance,
- Policy conflicts.

Among the various alternatives, geological disposal is certainly the one which is nearest to practical solution, while the others - which may be called "advanced solutions" - still require a good deal of preliminary studies before they can be considered as candidates for alternative management schemes.

This does not mean, of course, that they should not be studied, and project 2 of this programme refers to one of these advanced solutions. We insist, however, on the fact that a convincing, exhaustive and quantitative analysis of waste disposal hazards, carried out with scientific rigour, and not simply on the basis of educated guesses, seems now possible only for geological disposal options, which are therefore the only ones which are considered here.

The objective of the present project is indeed to contribute to such exhaustive evaluations, by first setting up methods for such an analysis (based on the barrier approach, already extensively used for reactor safety analysis) and then by contributing with an "ad hoc" set of experimental studies to minimize the uncertainties connected with the evaluation of the barriers' value.

Most studies on waste hazard evaluation are based on rather similar working hypotheses, which may be roughly summarized as follows:

- Gradual and continuous increase of the number of nuclear power plants, tending to a total of 100-200,000 MWe for each large industrialized European country towards the year 2000 (3).
- Gradual substitution of light water reactors (LWR) with fast breeder reactors (FBR), starting in the middle of the next decade.
- Fuel reprocessing carried out in reprocessing centers capable of handling approximately 1000 ton/year of LWR fuels (coming from approximately 30 x 1000 MWe reactors) or a quantity corresponding to about the same electrical output from FBR fuels. The plants are based on aqueous reprocessing (Purex Process), including a special head-end for FBR fuels.
- Aqueous high activity waste is concentrated and stored at the reprocessing plant for a variable period of time, up to a few years, and then solidified, presumably in a vitrified form, and stored on site for many years. It is finally transported to a deep geological formation for permanent disposal.
- The future trend for medium activity waste is still uncertain.

It is very hard to define suitable parameters which could quantitatively state the long-term hazard. Various parameters and criteria have been suggested by different authors (3-6, 8,9), none of which are fully satisfactory, particularly since they do not take into account the environmental behaviour of actinides, and the critical pathways to man, should the geological barrier fail.

Therefore, we are dealing today with a double uncertainty: first, we are dubious as to the best concept of permanent disposal; secondly, we do not know how to express quantitatively the safety of a given disposal option. The two problems are obviously, closely connected.

Various hazard assessments are being carried out in the EEC and outside: the practical involvements, in terms of manpower, budget and facilities remain, however, very different from one country to another.

Technical approaches to the problem are different as well:

- granitic and salt formations are being considered in France, by CEA,
- clay formations are being studied in Italy (until 1972 under Euratom contract, now by CNEN) and Belgium,
- salt mines are already used in Germany for low level waste disposal and are being considered for HLW disposal by both Germany and the Netherlands.

In the EEC not only the attitude towards the permanent disposal options is different from country to country, but also the time scale of the necessary R & D work are not the same: Great Britain, for instance, considers it to be satisfactory, for the moment, to store concentrated aqueous wastes in tanks, while developing a process for their vitrification; the vitrified products are foreseen to be stored on the reprocessing site, in man-made structures. In the future it will be easier than now to tackle the ultimate disposal problem.

Such large differences in attitude toward the radioactive waste problem and the proposed solutions are of course also related to differences in geographic, political, social and economic situations of the various countries, and, moreover, they develop continuously with time.

Many international organizations are also dealing with the problem of nuclear wastes. The NEA, which has been organizing for many years sea dumping operations for low-level waste, has organized, jointly with the IAEA, or alone, congresses on the management and disposal of radioactive wastes (10-12). It has also started a programme for the treatment and solidification of the wastes accumulated by the reprocessing plant of Eurochemic, and has constituted a working group on "Etude des pratiques de gestion de déchets radioactifs".

The IAEA is active in examining and publishing regulations for radioactive materials transport and requisites for sea dumping. Working groups and panels on the various aspects of waste management are also periodically organized.

Finally, the recently established International Energy Agency (IEA) is periodically assembling working groups on waste management, and it is likely to play a major role in the organization of joint ventures on waste management.

The situation is therefore still rather "fluid" and a great effort will certainly be required to unify the existing trends

into a few and well-defined strategies for waste disposal. The approval of the CEC indirect action programme on waste management is certainly an important step forward towards the rationalization of efforts and the development of a few forward geological disposal options for the European countries. The availability of an independently developed method for hazard evaluation, which is the purpose of this project, should further help in settling a solution for the waste disposal problems at a Community level.

The proposed project derives directly from studies which are being carried out in the present programme (13,14) with favourable advice from the waste advisory committee.

A "model 1" hazard evaluation model has been developed, which was used to orient the experimental studies on the stability of conditioned waste towards well-defined practical objectives. In that model the principal types of alpha-bearing wastes produced in a hypothetical reprocessing plant and associated Pu-fuel fabrication plant were taken into account, and figures were given for the relative quantities and compositions. We concluded that, while HAW's bear the largest fraction of the total alpha-activity, the contribution of the other types of wastes cannot be neglected, their relative importance increasing with time.

Physico-chemical models were set up for the interaction of conditioned wastes with leaching water: from these, we were able to calculate the modes of the alpha-activity release from a repository as a function of time.

By assuming that the activity is carried by a groundwater flux, the migration rate and the delay induced by soil columns for various actinides were calculated. Tentatively, a fault tree analysis was also done, by using the fault-tree described in ref. 7. We wish to indicate that in this centre vast experience was achieved in the field of failure and event analysis.

## 1.2. TECHNICAL DESCRIPTION

The project is organized into four studies:

- waste hazard analysis
- long-term stability of conditioned waste
- interaction of actinides with the environment
- actinides monitoring

A technical description of the studies is reported below where connections with Indirect Actions and national initiatives are also indicated. Planning is reported for each study in the form of flow sheets in section 1.4. where the requirements of staff and resources are also indicated.

### 1.2.1. Waste Hazard Analysis

The analytical models necessary for waste hazard evaluation will be developed and applied to various disposal options. The output results will assess the priorities and give the boundary conditions for the experimental investigations.

It is composed of two parts:

A model analysis of the hazard of geological disposal, in which one or a few disposal options will be investigated in detail with the objective of obtaining probability and levels of alpha-release, environmental distribution of actinides and related consequences vs. time. The system considered is shown schematically in Table E-I-03/a.

This study is the natural continuation of our present study "waste hazard evaluation".

The hazard evaluation model 1 which is presently being developed will be followed by a revised version (model 2) which will take advantage of criticisms of model 1 and of all new generated input data.

Model 2 will be applied to various disposal strategies such as salt and clay formations and sea bed disposal. In the second part of the programme this model will be applied to specific disposal sites indicated as promising, also taking into account the results of the indirect action on geologic disposal.

A more general analysis of the system "waste disposal" in which various options will be evaluated and compared with the objective of optimizing the choices of disposal options from various points of view (economy, pollution, safety, reliability). The system considered is shown in Table E-I-03/b. The evolution of the work is by successive approximations, as it is for hazard evaluation studies. This study is the natural continuation of our present study "Data Evaluation".

The 1976-1980 programme of indirect actions can provide many input data to the proposed study, particularly after 1-2 years of general orientative work from both sides. The same is true for the Radiobiology Programme (1976-1980) which has been presented to the Council of Ministers and which includes experimental studies on the environmental distribution of actinides.

Similar work presently underway in various national institutes will also be followed. A workshop on this item has already been done at Ispra and we plan to continue the initiative.

#### 1.2.2. Long-Term Stability of Conditioned Waste

The objective of this study is to obtain the information on long-term behaviour of conditioned high and medium-level waste which is necessary for waste hazard evaluation.

##### 1.2.2.1. High Activity Waste

In the present programme the long-term behaviour of high activity waste conditioned as borosilicate glass is being investigated. The following studies are underway:



- a) effect of radiation damage by alpha-particles and recoil nuclei (simulation by fission fragments on model glasses),
  - b) long-term effects of glass leaching (leaching rate of actinides at equilibrium),
  - c) effects of helium build-up on physical integrity,
- Study c) should be completed by the end of the programme, while a) and b) will continue during 1977.

During 1977-1981 we plan:

- to complete the studies on alpha-radiation damage (completion of simulation tests, control experiments on real vitrified waste, preferably by contracts),
- to complete the study on glass leaching, (particularly exchange reactions in the gel surface layer of the glass),
- to carry out stability tests on other conditioning types which may be proposed (see for example metal inglobation, study no. 3 of the indirect programme).

#### 1.2.2.2. Alpha-contaminated Waste

We define as such all types of waste which can be classified as low or medium level waste for what concerns beta-gamma activity, but with alpha-activities which are high enough to cause a long-term alpha-hazard. They include solid alpha-waste from Pu-fuel fabrication, liquid waste from solvent clean-up or Pu-purification in fuel reprocessing and other miscellaneous waste.

Inglobation in bitumen has been considered for this type of waste. The main advantage is a good long-term stability in abiotic environments. The radiation damage has been mainly studied for its short-term implications (hazard from the formation of H<sub>2</sub> and CH<sub>4</sub> gases, swelling). For long-term implications the formation of open porosity is the main point of interest, resulting in large increase in the leaching rate. The correlation between Na and Cs leaching and their diffusion in bitumen has been studied, but no data exist on the long-term leaching of bitumen itself.

We propose therefore the following studies:

- study of alpha-radiation damage of bitumen. Evaluation of the amount of energy which is necessary to produce open porosity;
- study of leaching of bitumen and of the inglobated compounds (as ions or oxides). Various bitumen types will be studied, and the absorbed energy will be an important parameter;
- effects of bacteria on bitumen (by contract);
- preliminary experiments on alternative inglobation matrices.

The study presently underway on glass stability have been planned after discussions with various national laboratories (GFK, Karlsruhe; Hahn-Meitner Institute of Berlin; CEA, Marcoule; CNEN) in order to avoid unintentional duplication of efforts.

Alternative to bitumen are presently being studied in many laboratories. They may provide in due time a motivation to reorient the activity proposed for alpha-contaminated waste. They will therefore be closely followed.

### 1.2.3. Interactions of Actinides with the Environment

The objective of this study is to describe in quantitative terms the time-dependent evolution of actinides in the environment, following a failure of the geological barrier. The necessary analytical models are developed under item 1.2.1. (waste hazard analysis).

This study:

- carries out a continuous literature search, to provide input data for the analytical model,
- carries out those experimental studies which will be necessary to complete the data. The main effort in this area will be devoted to the interaction with the abiotic environment, which can be considered as a barrier. Physico-chemical forms of leached out actinides and their interaction with the geological environment (clay, in particular) will be the most important items. Special attention will be paid to small-rate interactions, which might not be detected by the current analytical experimentation, but which can play a most important role in waste retention by geological media.

Interactions of actinides with the biosphere will not be directly studied. It is envisaged, however, to undertake joint actions between the JRC and the Radiobiology Programme, in which the JRC provides the nuclear and radiochemical competence. A special effort should be devoted to the possible production and use of "low hazard" actinides, (electron capture X-ray emitters with 2-40 d half-life, such as  $^{237}\text{Pu}$ ,  $^{240}\text{Am}$ ,  $^{241}\text{Cm}$ ) which may safely be used in field and laboratory operations.

The most important partner in this study will be the CEC Radiobiology Programme. The type of interplay should be:

- mutual exchange of information
- request for studies to be carried out under the Radiobiology programme
- nuclear and radiochemical support to Radiobiology programme (special isotope preparation)
- joint experimental actions

#### 1.2.4. Actinides Monitoring

Monitoring of actinides in solid wastes requires application of radiometric methods, which are based on the detection of highly penetrating nuclear radiation specific to alpha-active nuclei. Obviously, a direct measurement of alpha-particles is not possible due to their extremely short penetrability through matter of which the wastes are composed. Representative sample preparation is also not practicable.

Four approaches are currently used:

- a) Measurement of gamma-activity,
- b) Measurement of spontaneous fission activity,
- c) Measurement of neutrons from ( $\alpha, n$ ) reactions with light nuclei present in the waste,
- d) Measurement of neutron-induced fission rates.

Gamma-activity methods are applicable in the absence of substantial amounts of fission products and highly absorbing waste materials.

Spontaneous fission activity methods do not have this limitation, but they are insensitive to some important actinides such as Am 241. Detection limits of both methods are of the order of mCi. At present gamma and/or spontaneous fission activity methods are most frequently applied to Pu-monitoring in solid wastes. Instruments of this kind are already commercially available. The emission rate of neutrons from ( $\alpha, n$ ) reactions cannot easily be correlated with the alpha-activity, because it depends sensitively on the chemical composition and physical form of the waste. When this information is available, this method can be quite powerful.

Neutron-induced fission methods are mainly of interest in connection with Pu-monitoring at low detection limits, where most other methods fail.

Radiometric methods in general are sensitive to variations of geometry and to material compositions of the samples. For this reason sample categorization and standard measurement practices are required.

Important activities in this field have been started recently by the American National Standard Institute (ANSI) under the sponsorship of the "Institute of Nuclear Materials Management (INMM) but very little has been undertaken elsewhere.

The JRC-Ispra was charged in 1974 with the installation of a laboratory for the standardization of actinide monitoring techniques with the goal of providing services in this field to nuclear facilities of the European Community. At the end of the current research programme (1976) standard practices should be available for Pu-monitoring in 30 ltr, 100 ltr and 200 ltr low level solid waste drums. However, the bulk of the needs for actinide monitoring is still ahead. The proposal for the new multi-annual programme is therefore a continuation of the current programme.

The proposed actions are based on actual demands from Pu-handling facilities:

- development of actinide monitors for medium level solidified wastes by neutron techniques;
- development of actinide monitors for high level solidified wastes by neutron techniques;
- development of Pu-monitors for discards from dismantled Pu-handling facilities by neutron - and gamma - techniques.

Collaboration contracts with nuclear facilities which are producing or processing actinides-contaminated solid wastes must be established. This collaboration will allow the practical orientation of the development work and make available required sample materials. Contracts with national and international "standardization institutes" through our BCR and BCMN-Geel must be established for the development of standard procedures.

### 1.3. PLANNING

Planning is given for each study in the form of flow-sheets. (See Tables E-I-03/c, E-I-03/d, E-I-03/e and E-I-03/f)

### 1.4. MANPOWER AND COSTS

PROGRAMME : NUCLEAR MATERIALS AND RADIOACTIVE WASTE MANAGEMENT				
PROJECT 1 : EVALUATION OF LONG-TERM HAZARD OF RADIOACTIVE WASTE DISPOSAL				
	1977	1978	1979	1980
RESEARCH STAFF	29	29	29	29
INVESTMENTS (K.U.A.)	30	30	30	30
RUNNING COSTS (K.U.A.)	160	160	160	160
CONTRACTS (K.U.A.)	160	160	160	160

### 1.5. CONTRACTS

Contract studies with outside contractors will possibly be placed on the following items:

- the development of a model for the long-term leaching from bituminized waste (assessment studies),
- specific aspects of waste system analysis (fault tree analysis of the failure of geological barriers),
- specific aspects of environmental distribution of actinides (distribution coefficient of selected actinides in selected transfers).

### 1.6. REFERENCES

- (1) "Overview of High-Level Radioactive Waste Management Studies" by the Nuclear Waste Technology Department, BNWL-1758 (1973)
- (2) "High-Level Radioactive Waste Management Alternatives", WASH-1 9 (1974)
- (3) Mc GRATH, P.E.; "Radioactive Waste Management-Potentials and Hazards from a Risk Point of View", KFK-1992 (1974)
- (4) BELL, M.J., DILLON, R.S.; "The Long-Term Hazard of Radioactive Wastes Produced by ..." ORNL-TM-3548 (1971)
- (5) GERA, F., JACOBS, J.; "Considerations in the Long-Term Management of High-Level Radioactive Wastes", ORNL-4762 (1972)
- (6) CLAIBORNE, H.C.; "Neutron-Induced Transmutation of High-Level Radioactive Waste", ORNL-TM-3964 (1972)
- (7) "High-Level Radioactive Waste Management Alternatives", BNWL-1900 (1974)
- (8) HAMSTRA, J.; "Possibilities in the Netherlands for Disposal of Solid Radioactive Wastes in a Salt-Formation", RCN-74-026 (1974)
- (9) VERKERK, B.; "Some Criteria for Ultimate Disposal of Alpha-Contaminated Solid Waste", RCN-74-089 (1974)
- (10) "Management of Low-and Intermediate Level Radioactive Wastes", Aix-en-Provence, Sept. 7-11 (1970)
- (11) "Management of Radioactive Wastes from Fuel Reprocessing", Paris, Nov. 27 - Dec. 1 (1972)
- (12) "Disposal of Radioactive Waste", Paris, April 12-14 (1972)
- (13) GIRARDI, F., BERTOZZI, G.; "Long-Term Alpha-Hazard of High Activity Waste from Nuclear Fuel Reprocessing", EUR-5214 (1974)
- (14) BERTOZZI, G., GIRARDI, F.; "Nuclear Waste Disposal Programme: Technical Note", (unpublished) (1974)

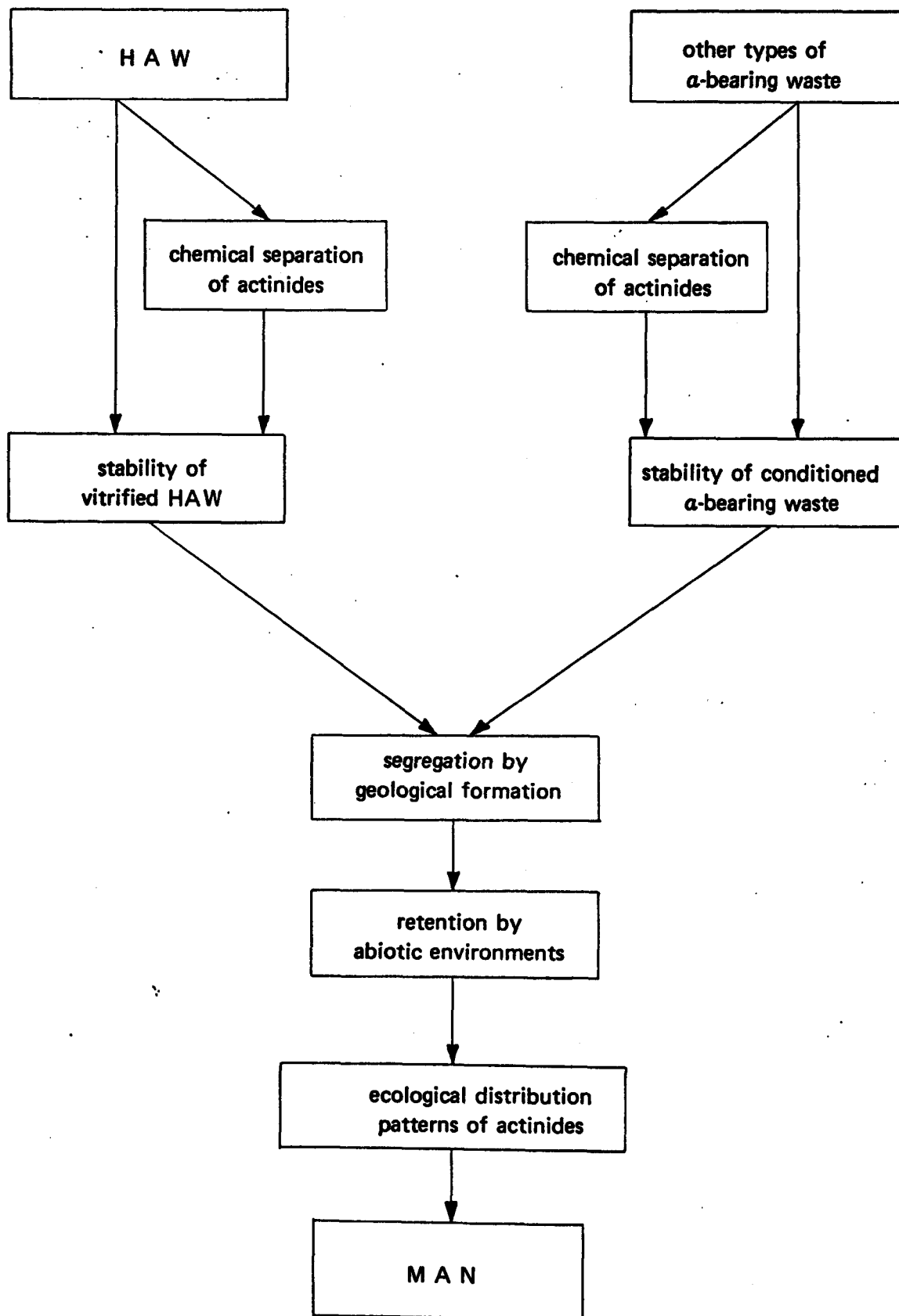

Model for hazard analysis of waste disposed in geological formation

Table E-I-03/a

136

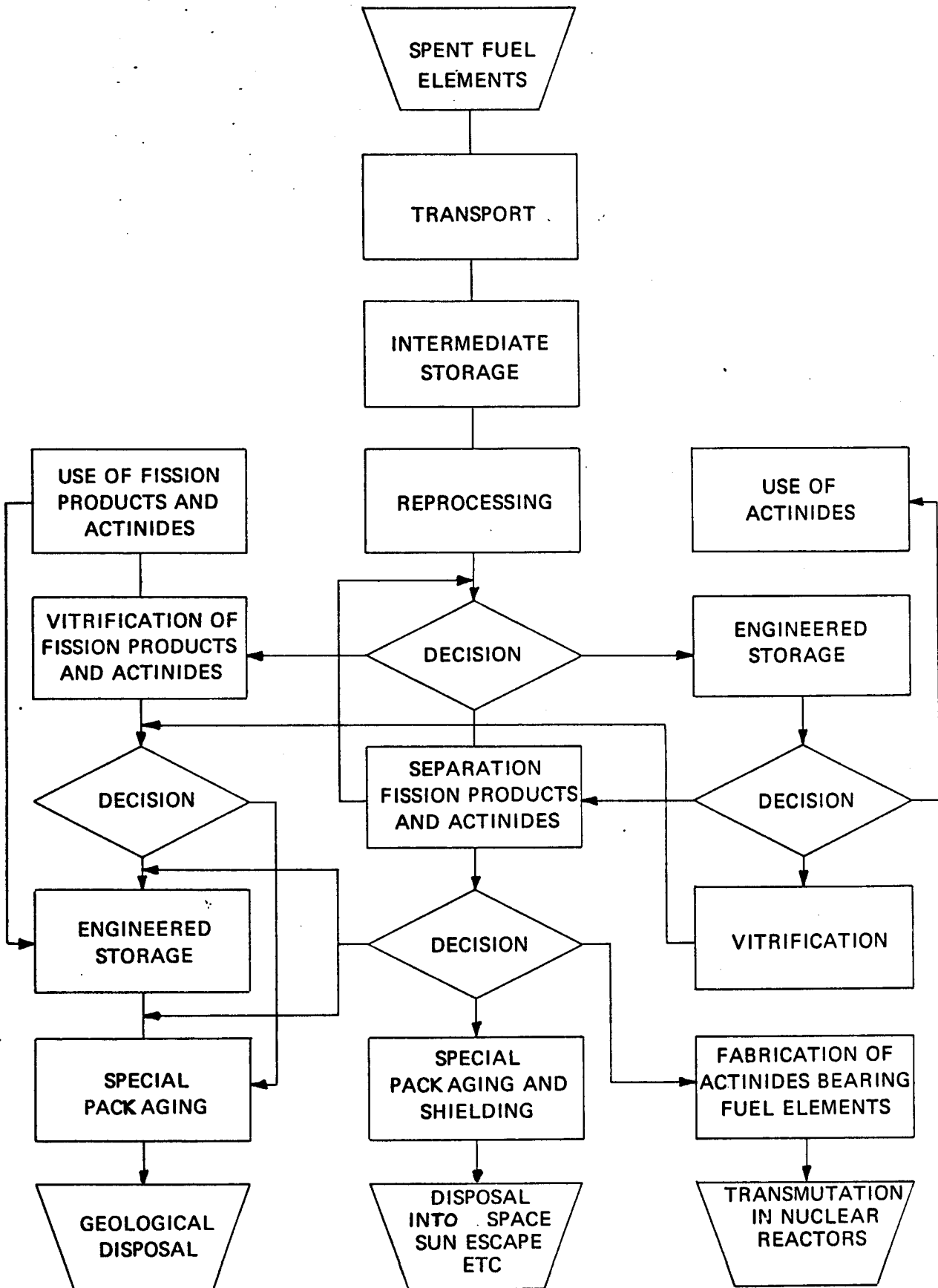

Possible steps concerning treatment and disposal of waste from nuclear reactors

Table E-I-03/b

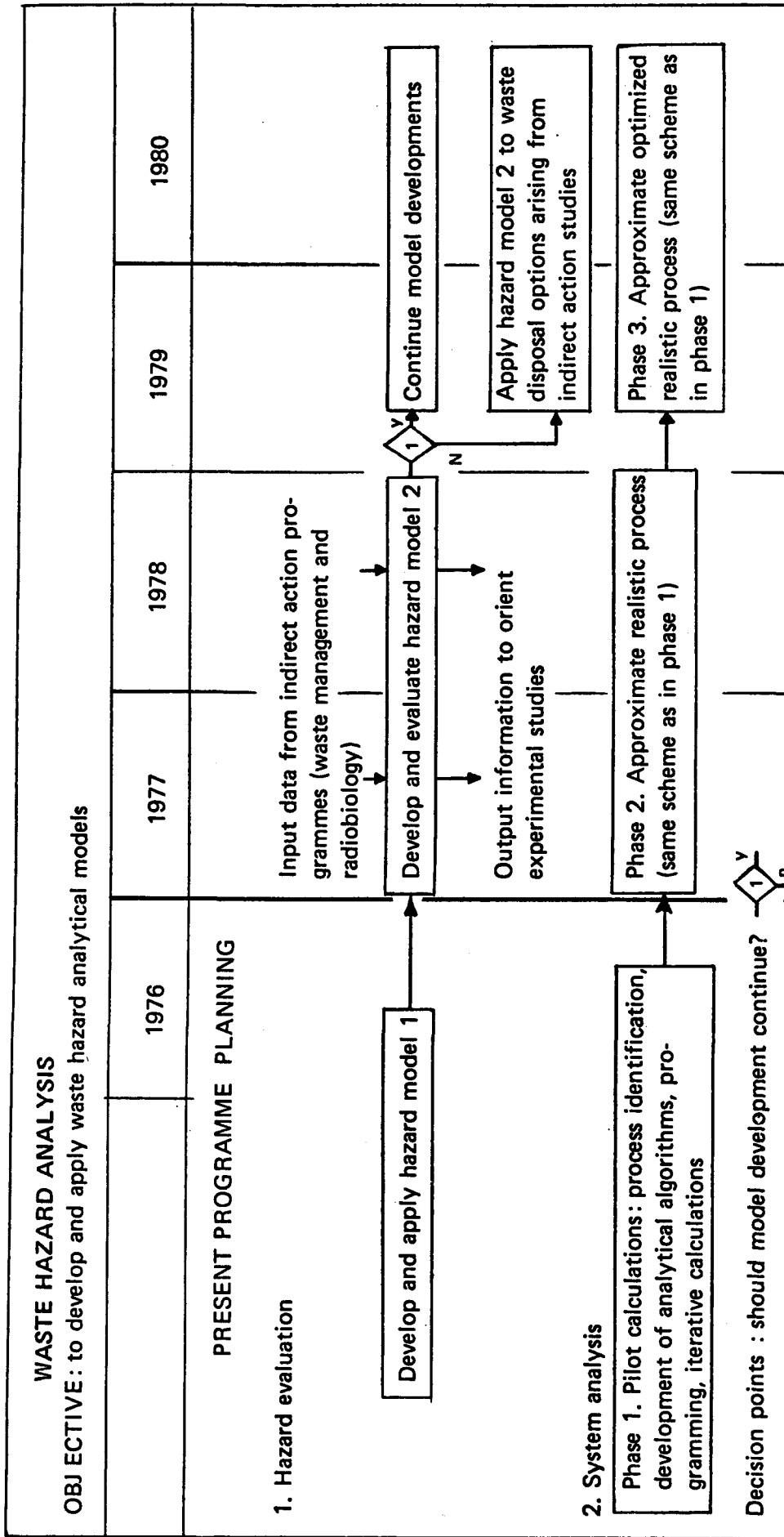

TABLE E-I-03/C



LONG-TERM STABILITY OF CONDITIONED WASTE				
OBJECTIVE: to obtain information on the long-term behaviour of conditioned waste				
1976	1977	1978	1979	1980
PRESENT PROGRAMME PLANNING				
		radiation damage of glass		
		leaching of glass		
		studies on bitumen		
			studies on other matrices	

TABLE E-I-03/d

INTERACTION OF ACTINIDES WITH THE ENVIRONMENT				
OBJECTIVE: to describe the time-dependent evolution of actinides in the environment				
1976	1977	1978	1979	1980
PRESENT PROGRAMME PLANNING				
<p style="text-align: center;">no activity during the present programme</p>				
<p style="text-align: center;">Should this item be continued?</p>				
<div style="display: flex; justify-content: space-between;"> <div style="width: 20%;"> <p>1. Survey of external activities. Adapt data for study 1.1 (Hazard analysis)</p> <p>Request of information and research to Radiobiology Programme</p> </div> <div style="width: 40%; border: 1px solid black; padding: 5px;"> <p>2. Interactions with abiotic environments (experimental studies)</p> <p>Problems:</p> <ul style="list-style-type: none"> <li>a) chemico-physical state of leached-out actinides</li> <li>b) interaction with inferior soil horizons, long-term evolution trends</li> </ul> </div> <div style="width: 20%; text-align: center;"> </div> <div style="width: 15%;"> <p>3. Interactions with the biosphere: Joint actions with Radiobiology e.g. development and use of "low hazard" actinides for field and laboratory studies</p> <p>decisions on Radiobiology Programme</p> </div> </div>				

TABLE F-I-03/e

<b>ACTINIDES MONITORING</b> <b>OBJECTIVE: development of standard practices for monitoring actinides in solid waste streams</b> <b>information and consulting service for nuclear facilities</b>				
1976	1977	1978	1979	1980
<b>PRESENT PROGRAMME PLANNING</b>				
<div style="border: 1px solid black; padding: 5px; width: fit-content; margin: 0 auto;">                     Standardization of equipment and measurement procedures                 </div>				
<div style="display: flex; justify-content: space-around; align-items: center;"> <div style="border: 1px solid black; padding: 5px; width: 30%;">                         1                          Development of actinide monitors for solidified medium-level waste                     </div> <div style="border: 1px solid black; padding: 5px; width: 30%;">                         2                          Development of actinide monitors for solidified high-level waste                     </div> <div style="border: 1px solid black; padding: 5px; width: 30%;">                         3                          Development of actinide monitors for discards from dismantled process equipment                     </div> </div>				

TABLE E-I-03/f

## 2. PROJECT: CHEMICAL SEPARATION AND NUCLEAR TRANSMUTATION OF ACTINIDES

### 2.1. BACKGROUND

This project is the direct continuation of the studies already under way on the feasibility of chemical separation of actinides from waste and their nuclear transmutation by fission reactors.

The objective of this project is to obtain by the end of the programme a clear understanding of the technical feasibility and interest of this advanced strategy. Alternative management schemes which may arise due to the chemical separation step will also be evaluated.

The actions proposed do not cover all problems posed by this advanced strategy, which are indeed many, and very difficult to solve.

The existence of an indirect action on the same subject may lead to a joint venture in which all resources available will be used to their optimum.

The transmutation of actinides into short-lived fission products by means of irradiation in a nuclear reactor was proposed by H.C. Clairborne in December 1972 and rapidly gained a wide acceptance in the nuclear scientific world as an appealing ultimate solution of the actinides problem. In an IAEA panel in Vienna in November 1972 and in a joint NEA-IAEA Congress on high activity waste management in December 1972 the matter was publically discussed and it was stated that research in chemical separation and transmutation of actinides was to be encouraged.

The suggestion to the EEC Commission to include in the pluriannual plan 1973-1976 of the JRC a research on chemical separation and nuclear transmutation of actinides was also forwarded by the Dutch representatives to the EEC Commission during November 1972 and a programme on the matter was finally approved by the Council of Ministers on February 1973. After this sudden flash of enthusiasm on actinides transmutation, a period of reflection followed.

It was in fact soon realized by a large fraction of the scientific community that although the advantages of the concept continued their appeal, the difficulties had to be determined more accurately. The concept called for a separation of Am, Cm and residual Pu from high activity waste with decontamination ratios of  $10^3$ - $10^4$ , which appeared to be far beyond the present technological possibilities of reprocessing industries.

Similarly the implications of the presence of greater concentrations of short lived heavier actinides during fuel handling, reprocessing and refabrication appeared to be rather heavy for a new industry such as fuel refabrication.

Weighing up the positive and negative aspects of the problems resulted in an intermediate statement: chemical separation of actinides and nuclear transmutation should be studied as one of the "advanced" strategies (such as others mentioned under project 1) with the understanding that advanced management option studies should not only aim at demonstrating the technical feasibility of the concept, but also

at a careful study of the drawbacks and at a convincing justification of the large financial effort needed to develop new advanced technologies.

This statement is the basic motivation for splitting the proposed JRC waste disposal studies into two separate projects, one on hazard evaluation of geological disposal options (project I) and one on chemical separation and nuclear transmutation (project II).

Chemical separation studies are essentially carried out at trace simulation level, at Battelle N.W. Lab. and Oak Ridge Laboratories in USA at a rather low level of financing (2, 3, 4). Studies on chemical separation of Am and Cm from HAW were carried out at GfK Karlsruhe (on simulated waste solutions) during 1971-1972 with the objective of recovering valuable amounts of these nuclides (6). The project was then abandoned for lack of commercial interest.

Assessment studies on nuclear transmutation feasibility are carried out in many laboratories both in USA and Europe (3, 5, 7). Japan has also recently started a programme which includes both theoretical and experimental activities (cross section measurements).

Obtaining more accurate cross section data is a prerequisite for accurate assessments, and activities in that direction are under way at Oak Ridge, Harwell, Karlsruhe and also at the European Institute for Transuranium Elements in the frame of the JRC programme.

In the new programme of the indirect action on waste management, an activity is included on nuclear transmutation (action 9) with a community contribution of 0.76 MUC over five years. The action foresees studies on all items pertaining to this management strategy, but the limited amount of funding will either limit the action to the evaluation of theoretical studies or to selected experimental activities. A good co-ordination with existing and proposed Community's activities is therefore necessary and will be carried out within the frame of the corresponding (ACPM) common for direct and indirect action.

## 2.2. TECHNICAL DESCRIPTION

The project has been divided into three actions one of which is the theoretical (Assessment studies) and two experimental (Chemical waste partitioning studies, cross-section measurements).

Great importance was given to chemical separation problems, which are a crucial aspect of this management option, and moreover, could give rise to other waste management options of considerable interest, such as separate disposal of actinides and fission products.

The technological implications of Cm-rich fuels in the fuel cycle are only considered here theoretically. Capsule irradiation experiments could eventually be considered in the second part of the project.

Planning is reported in the form of flow-sheets under section 3, together with staff and budget requirements.

### 2.2.1. Chemical separation of actinides

The objective of this activity is to obtain by laboratory experiments the information needed to propose a complete flow-sheet for actinides recovery from high activity waste. Recovery from other liquid wastes will eventually be considered in the second part of the programme.

This activity is a continuation of the activity already under way within the present programme.

The laboratory studies on oxalate precipitation should be completed during 1976, by carrying out precipitation experiments on actual HAW samples.

If favourable results are obtained, the study should proceed by tackling the technological aspects of oxalate precipitation and separation by contracts.

Solvent extraction on a first set of extractants (HX-70, HDEHP, TBP) and experiments on HAW denitration by formic acid will also be terminated by the end of 1976.

Organic extractants such as bidentate organo-phosphorous compounds (DBDECMP, DHDECMP) and other alkylphosphoric acids (HEHOP) will be investigated during 1977, essentially by batch equilibration experiments and radiation stability tests.

The most promising of the mentioned extractants will be tested in continuous countercurrent conditions during 1978 with the objective of obtaining a tentative flow-sheet.

The tentative flow-sheet will be verified on high activity samples during 1979 and 1980.

Typical HAW solutions will be used in the shielded remote controlled facilities of the JRC.

Solvent extraction studies will be extended to rare earths-actinides partitioned from separated oxalates, if positive results are obtained on the oxalate precipitation tests with real high activity waste.

If negative results are obtained on a proposed solvent at any point of the described sequences research will be directed towards alternative organic extractants, and plans will be modified accordingly.

### 2.2.2. Assessment studies on/and nuclear data for actinides transmutation

#### Technical description:

On the basis of the results of the assessment studies at present under way on the production and burning of actinides in a nuclear reactor, the following main aspects require further research effort:

- the verification of the feasibility of actinides recycling in fission reactors from a neutron physics point of view,
- the improvement of nuclear data for actinides and the sensitivity studies related to them.

The first point aims at a deeper analysis of some problems which are considered very important for the feasibility of actinides recycling.

In particular, during the separation of actinides in the re-processing phase, some losses will be encountered and the separation from rare earths will not be complete. The evaluation of the hazards due to these losses as well as the study of the influence on the reactor core reactivity of residual rare earth elements present with actinides will be important.

In addition, a detailed technical and economic investigation of the implication of actinides recycling on fuel cycle and reactor safety has to be performed for various strategies of recycling in proven reactors, advanced converters and fast reactors.

As far as the second point is concerned, the improvement of nuclear data is aimed at providing basic information which is needed for reliable calculations of actinides recycling in various power reactors.

In particular, it is intended: to derive mutual and self-shielding factors for fuel elements for thermal reactors containing an important concentration of actinides; to set-up and/or improve nuclear cross sections for typical fast neutron spectra; to derive high energy nuclear data by theoretical models (evaluation of  $(n,2n)$ -,  $(n,3n)$ -,  $(n,\alpha)$ -cross sections by the UHL-Code).

Finally, some sensitivity studies of nuclear data accuracy on the in-core behaviour and fuel cycle processes will throw light on the direction in which the research effort should be further devoted.

The first part of the study will integrate with the effort foreseen in the indirect action as previously indicated.

The study on nuclear data may partly be developed in collaboration with activities going on in national laboratories such as HARWELL and CNEN.

### 2.2.3. Cross section measurements

The objective of the present work is to gain a fuller knowledge of the fission cross sections of actinides, as required for an accurate evaluation of the transmutation rate in various neutron energy spectra.

Two types of measurements are planned:

- a) Differential cross-sections in the 0.5-1.3 MeV neutron energy range .

These measurements will be a continuation of the work performed during the present programme in collaboration with GfK Karlsruhe. By the end of 1976 the measurements of the differential cross section of  $^{241}\text{Am}$  in the mentioned neutron energy range will be completed. A special effort was required in order to optimise the gas scintillation counter and associated electronic equipment due to high  $\gamma$ -background ( $^{10}\text{C}$ -disintegration for 1 fission signal). It is proposed to use the equipment and technical experience

now available for the measurement of other transuranium actinides cross sections of interest for nuclear transmutation, to be chosen in co-operation with other institutions (see fiche 9, indirect programme).

- b) Integral fission cross section in a  $^{252}\text{Cf}$  spontaneous fission neutron spectrum.

The differential fission cross section data suffer from the fact that these data are measured by different experimenters in different energy ranges. The errors of the cross section data changes across the energy interval and is generally most pronounced near its boundaries.

For a cross section evaluation joining the data to a uniform cross section set, it is often difficult to find the most correct way of doing this. Under these conditions integral cross sections help to check the consistency of calculated data.

We propose therefore to extend the present programme by including measurements of integral fission cross sections in a  $^{252}\text{Cf}$  spontaneous fission neutron spectrum.

This spectrum is considered as an important standard spectrum for checking the consistency of evaluated cross section sets especially in the fast energy region, where nuclear transmutation of actinides is most effective.

The magnitude of the problem, the limited amount of resources available and the unavoidable specialization of the different laboratories on specific types of measurements depending on the nuclear facility available impose the necessity of a cooperative effort by many laboratories. Contacts have already been established between JRC-Ispra and Euratom BCMN at Geel, Euratom Transuranium Institute and GfK in order to avoid unintentional duplication of experiments. A joint effort, eventually including similar initiatives under way in the U.S.A. should allow a good coverage of the subject within a reasonable time scale.

- c) Integral cross-sections in reactor spectra

Measurements of integral cross-sections in reactor spectra are carried out at the Transuranium Institute (Karlsruhe Establishment of the JRC) essentially within the framework of the plutonium fuels and actinides research programme. Nevertheless, the measurements specifically useful to the waste management programme will be carried out under this project 2. Hence the complementarity of the JRC's efforts in this field will be ensured.



2.3. PLANNING

Planning is given for each study in the form of flow-sheets.  
(see Tables E-I-03/g, E-I-03/h and E-I-03/i)

2.4. MANPOWER AND COSTS

PROGRAMME : NUCLEAR MATERIALS AND RADIOACTIVE WASTE MANAGEMENT				
PROJECT 2 : CHEMICAL SEPARATION AND NUCLEAR TRANSMUTATION OF ACTINIDES				
	1977	1978	1979	1980
RESEARCH STAFF	25	25	25	25
INVESTMENTS (K.U.A.)	30	30	30	30
RUNNING COSTS (K.U.A.)	170	170	170	170
CONTRACTS (K.U.A.)	160	160	160	160

2.5. REFERENCES

- |     |                             |                      |        |
|-----|-----------------------------|----------------------|--------|
| (1) | H.C. Claiborne              | Report CRNL-TM-3964  | (1972) |
| (2) | W.D. Bond and<br>R.E. Leuze | " ORNL-5012          | (1974) |
| (3) | H.C. Claiborne              | " ORNL-TM-4724       | (1975) |
| (4) | J.W. Bartlett<br>et al.     | " BNWL-1776          | (1973) |
| (5) | W.C. Wolkenhauer<br>et al.  | " BNWL-1772          | (1973) |
| (6) | G. Koch et al.              | " KFK-1651           | (1972) |
| (7) | D. Bréton                   | " EUR-CEA-FC-<br>723 | (1973) |

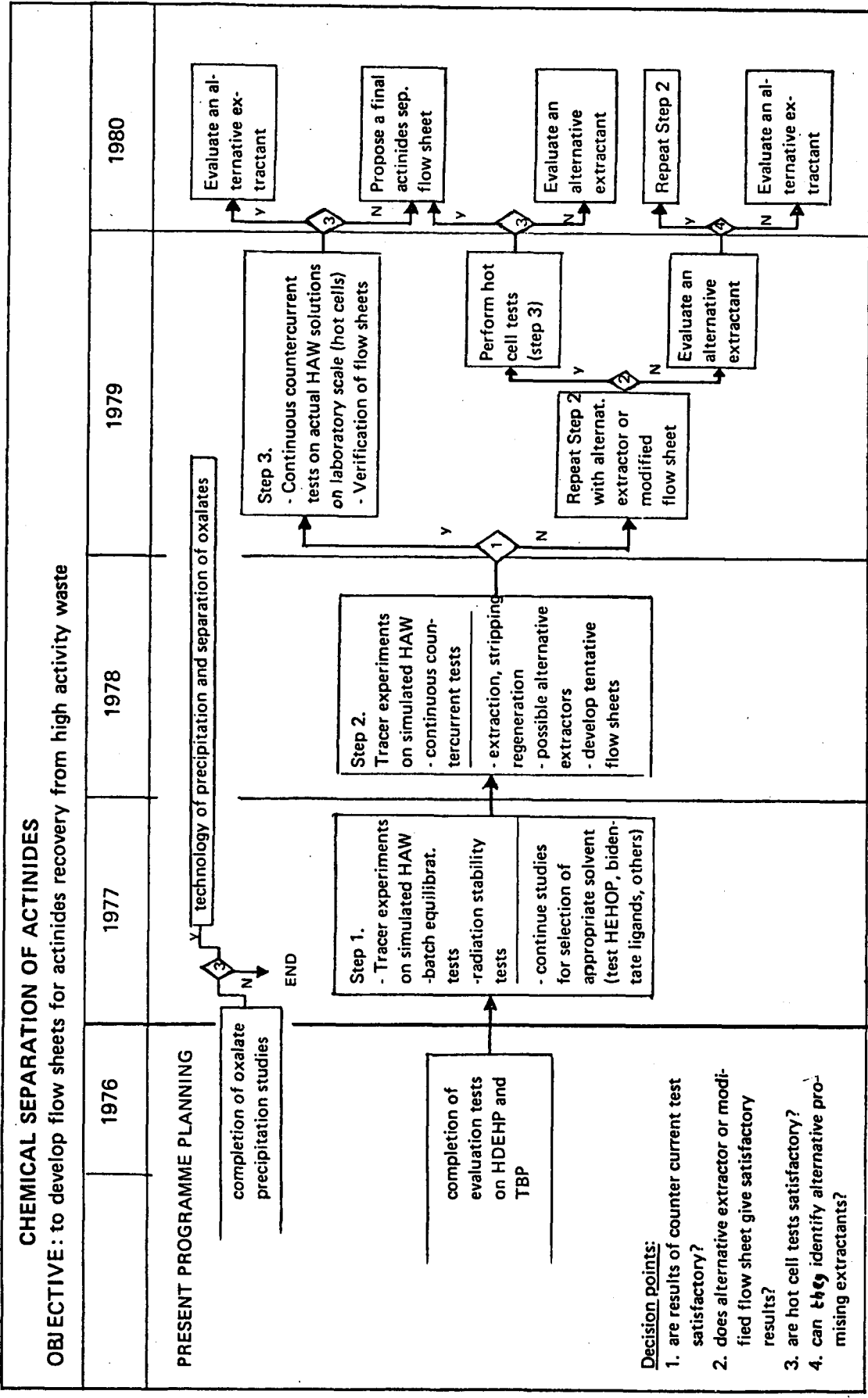

TABLE E-I-03/g

ASSESSMENT STUDIES				
OBJECTIVE : to evaluate the feasibility of nuclear transmutation of actinides and to improve the required nuclear data set				
1976	1977	1978	1979	1980
PRESENT PROGRAMME PLANNING				
<p>Studies of feasibility of actinides transmutation in fission reactors</p>	<p>Analysis of the influence of actinides losses in the fuel cycle</p>	<p>Implications of the presence of actinides in the reactor fuel cycle cost and on the fuel cycle management and safety</p>	<p>Study of the reactivity penalty due to rare earths impurities in separated actinides</p>	
<p>Improvement of nuclear data for actinides and sensitivity studies</p>	<p>Study of the mutual and self-shielding in a thermal neutron spectrum</p>	<p>Checking and improved evaluation of nuclear cross sections for fast reactors</p>	<p>High energy nuclear data by theoretical models</p>	

TABLE E-I-03/h

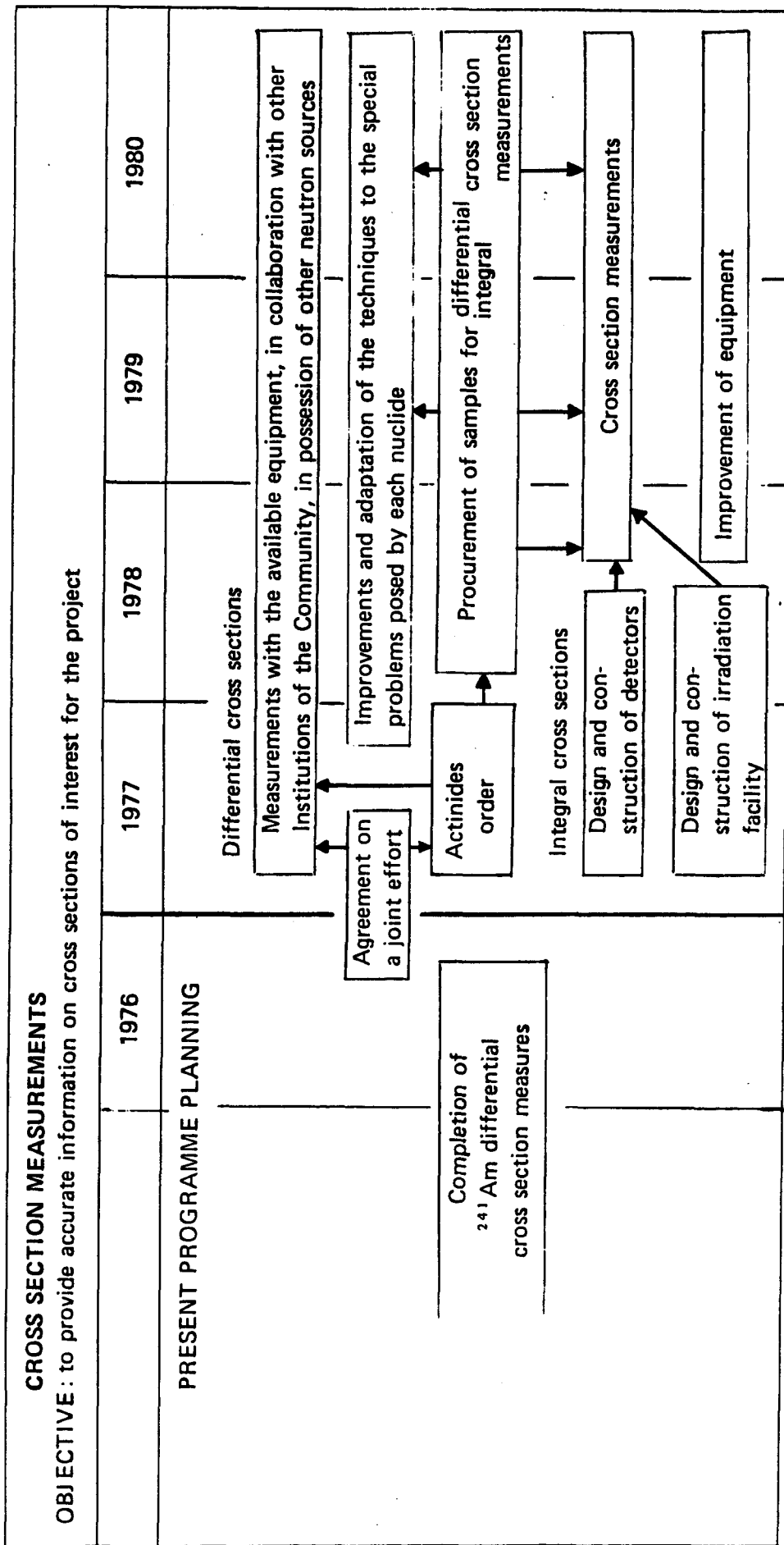

TABLE E-I-03/i

### 3. PROJECT: FUEL MATERIALS MANAGEMENT

#### 3.1. BACKGROUND

Fuel materials management, its efficiency and the accuracy of the methods used are important factors in the economy of operation of the fuel cycle and in the reduction of the hazards connected with the circulation of large amounts of fissile materials.

The aim of this project is to develop and ameliorate techniques and procedures required in fuel materials management and relevant to optimum reactor operation, commercial transactions, industrial quality control and environmental protection.

The accelerated growth of nuclear energy production and thus the increasing flow of fissile materials must be taken into account in designing future management procedures.

The project has been subdivided in three different studies:

- Bench Mark Experiments
- Isotope Correlations
- Non Destructive analysis

The scope of the Bench Mark Experiments is the production of a set of reference data on burn up, isotopic compositions and on cross sections ratios. Radiochemical analyses of fuel samples irradiated in well known conditions deliver the raw data which are further analyzed. The data are then collected in a data bank and each fuel management group of the Community has access to them for the control and eventual adaptation of nuclear codes. Codes tested in this way will have an enlarged field of application and an improved accuracy on the prediction of burn up, Pu and waste production.

The second study, concerning the correlations between heavy isotopes and fission products on spent fuels, permits the verification of the internal consistency of isotopic data from fuel analysis and the deduction of the amounts of specific isotopes in the fuel from measurement of other isotopes using established correlations. It is for example an extremely useful tool for the determination of plutonium in the input solutions of reprocessing plants, which is of great interest in commercial transactions.

The non-destructive techniques, which are mainly based on neutron and gamma measurements, are particularly important for the fissile material determination in fabricated fuel pins and heterogeneous materials (scrap and waste) which cannot be subjected to classical chemical analysis. Important support may be given in this field particularly to fabrication plant operators for their quality control problems.

The fundamental research in this field can be considered completed: the future activity has to be directed towards the practical implementation of the techniques in plants and their standardization.

The activities proposed in the frame of this project are essentially an enlargement of the studies started before or during the previous pluriannual programme. The equipment for the execution of the studies exists to a large extent and the major investments during the coming year will be the renewal or adaptation of some old equipment. Competence in the several fields is now well established at the J.R.C. as can be deduced from the multiple contacts and requests made by external organizations to the J.R.C. A more specific motivation for each study is briefly illustrated below.

#### a) Bench Mark Experiments

The J.R.C. has four years of specific experience in the field of post irradiation analyses and Bench Mark's. Laboratories are now equipped for this purpose. Furthermore, the Advisory Committee for the programme "Support to Nuclear Power Station" expressed the opinion that post-irradiation analyses should be continued with greater effort.

A specialists meeting on "Fuel management" requested by the "Support to Nuclear Power Stations" and organized at Ispra, discussed the future needs in the fuel management of nuclear power stations. An agreement was obtained on a proposed programme of isotopic composition measurements and on their analyses in terms of one group cross section ratios, if sufficient data were to be made available.

Collaboration contracts have been established between EURATOM and KWU Erlangen, KWO Obrigheim, KWU Frankfurt and KRB Gundremmingen.

Continuous contacts are made with nuclear power stations and fuel management groups of the Community countries.

The J.R.C., being a Community organization, is particularly qualified to carry on Bench Mark studies as they are of general interest to fuel management groups.

The final goal of the Bench Mark programme is the establishment of a data bank to which all European fuel management groups will have access for the testing of their nuclear burn up codes and the input cross sections library.

#### b) Isotope Correlations

In the past, extensive work has been carried out at the establishments of Ispra and Karlsruhe on the correlations between heavy isotopes and fission products.

A data bank on isotopic correlations has been established at the Ispra establishment in collaboration with many reactor operators of the Community countries in view of the developments of the correlation techniques. This action can be considered for this reason as specific for a J.R.C.

In addition collaboration has been established for several years with the CEN/SCK (Belgium) and ENEL (Italy).

### c) Non Destructive Analysis (NDA)

In the J.R.C.-Ispra investigations on the use of gamma and neutron techniques have been carried out starting from 1969.

On the basis of these studies several apparatus have been developed which are now installed in nuclear plants.

The number of NDA methods used for management purposes within the nuclear fuel cycle is increasing continuously and the requests made to the J.R.C. for support have been numerous.

In the field of development and application of non destructive techniques, various collaboration contracts have been established with nuclear industries (EUROCHEMIC, NUKEM, ENEL, BELGONUCLEAIRE) and national centers.

Due to the experience gained by the J.R.C.-Ispra in this field and due to the relationships already established with the national research centers and the nuclear industries of different countries, the J.R.C.-Ispra seems to be particularly qualified to carry on work in this field in order to be able to compare independently NDA methods and techniques used in nuclear installations of different Community countries. The J.R.C. should also stimulate, through independent developments, the application of NDA techniques in nuclear plants.

## 3.2. TECHNICAL DESCRIPTION

### 3.2.1. Bench Mark Experiment

#### 3.2.1.1. Experimental Post Irradiation Analysis

Spent fuel elements irradiated in asymptotic conditions are obtained from the nuclear power stations and samples are drawn from them. These samples are analyzed by radiochemical methods to obtain the isotopic composition of the heavy elements and some fission products (about 30 samples a year may be analyzed).

The experimental work on uranium fuel for three Bench Mark Experiment are planned:

- The steel-clad fuel PWR bench marks will be completed with TRINO III and BR-3 VULCAIN
- The Zr-clad fuel PWR bench mark will be continued and completed with DOEL I, I and III
- After analysis of the GUNDREMMINGEN fuel, it will be decided whether or not to go on with BWR fuel.

#### 3.2.1.2. Elaboration of experimental data

From the experimental data on isotopic composition of the fuel, burn-up and one group cross section ratios are calculated.

Burn-up codes will be used to evaluate an eventual systematic error in the analyses results.



Unfolding codes are applied for neutron spectrum determinations.

It is also planned to deliver theoretical support to indirect action on "Pu recycling".

The work will be carried out mainly at Ispra, with a contribution in specific fields by the Transuranium Institute, Karlsruhe JRC Establishment.

### 3.2.2. Isotope Correlation Studies

The proposed activities concern experimental work for the study of the correlations, theoretical analysis of the correlations and interpretation of the experimental data, and operation of a data bank of isotopic compositions, collecting data produced in reprocessing operations and post-irradiation examinations.

It is proposed to continue these activities already going on now, in order to complete the present investigations which are mainly related with the LWR reactor and to undertake studies concerning other types of fuels such as plutonium recycling and fast reactor fuels (as requested from many sides).

#### 3.2.2.1. Experimental work on isotope correlations

The experimental work will be directed to produce isotope correlations data for heavy isotopes of Pu, U, and fission products, both radioactive ( $^{134}\text{Cs}$ ,  $^{137}\text{Cs}$ ,  $^{154}\text{Eu}$ ) and stable (isotopes of Kr and Xe). To this purpose fuels irradiated in different reactor types (PWR, BWR, fast reactors) will be analyzed.

The experimental work will also be directed towards the development of devices for monitoring gaseous and radioactive fission products.

#### 3.2.2.2. Theoretical Analysis

A complete assessment of the validity of isotope correlation requires a theoretical analysis directed at identifying the reactor and irradiation parameters influencing the correlation. The continuation of the analyses, already initiated in 1973, will concern the investigation of thermal reactor fuels other than those from PWR reactors, and fuels for fast reactors. The analysis will be subdivided into three main objectives: Correlations among heavy isotopes, correlations involving stable fission products and correlations involving radioactive fission products.

#### 3.2.2.3. Operation of the data bank

The data bank should collect all the information concerning fuel irradiation and post-irradiation fuel analysis useful for establishing the validity of isotope correlations. A questionnaire has already been distributed to all the utilities and reprocessing plants of the EEC in order to inquire whether the owners of such data are willing to collaborate. All reprocessing plants and a large fraction of the utilities have given a positive answer.

The work will be carried out mainly at Ispra with a contribution in specific fields by the Transuranium Institute, Karlsruhe JRC Establishment.

### 3.2.3. Non-destructive Analysis (NDA)

The following activities are proposed:

#### 3.2.3.1. Development and Practical Applications of NDA techniques

NDA techniques are essentially used to determine the isotopic abundance or the total quantity of a particular isotope in a sample.

While the basic principles of NDA techniques, mostly gamma and neutrons, are well understood, there is still a lack of practical measuring systems adequately developed and proved for use under plant conditions. As it was previously pointed out the NDA techniques are mostly applied in fuel fabrication plants and to a smaller extent in reprocessing plants and reactors. This means that there is a large variety of items to be assayed for their fissile material content (from complete fuel bundles to diluted waste solutions). Each time a critical study of the applicability of a particular NDA method and sampling method must be made, the technique and the available instrumentation has to be adapted to the plant conditions. Continuously, requests are made by plant operators to the J.R.C. for the development or evaluation of such methods.

Once a method has been studied, ad hoc instrumentation (applying for example microprocessors) must be developed or adapted. Automation of sample handling and programming of the measurements has to be foreseen. In the future, an important effort should be put on the measurement data handling and retrieval systems. These characteristics should make the techniques more industrially compatible.

It is proposed to continue the work in this field which has to be conducted mainly in the framework of collaboration agreements with nuclear plant operators.

The methods to be developed are particularly: non-destructive isotopic composition by neutron, gamma and calorimetric techniques on fresh fuel pins. Measurements of bulk material (homogeneous or not) especially by neutron techniques. Enrichment measurements on various types of solid materials, especially finished products and solutions.

#### 3.2.2.2. Standardization of non-destructive techniques

In order to be of value for plant to plant comparison, the measurement methods have to be standard techniques. Up to now, no reference procedure has been established for NDA techniques.

From the literature it appears that the standardization of NDA techniques is conducted at present through an important effort by the American National Standard Institute (ANSI). It is proposed that a similar activity of limited size is started in the Community for certain categories of techniques which have reached a satisfactory level of development and to suggest concepts of standardization in this field. The J.R.C. Ispra and other European nuclear centers can carry out the work of evaluating various techniques. In order to carry on this activity, and more particularly on techniques used in certain points specific to the European fuel cycle, well

equipped laboratories for neutron and gamma measurements have to be established at the J.R.C.-Ispra improving the existing instrumentation and increasing the existing staff. The basis of the infrastructure of such laboratories exists already but should be improved.

An important effort will also be directed to the preparation and characterization of reference physical samples, to be used for the calibration of NDA techniques, especially for Pu fuel, LWR fuel and HTR fuel.

Destructive analytical techniques are the basic ones for the determination of the fissile materials and give generally the most accurate results. Also the non destructive techniques are normally calibrated on the basis of destructive analyses.

The proposals in destructive analysis for the next pluriannual programme concern the participation in interlaboratory comparisons for the improvement and evaluation of the analytical techniques at the Ispra, Geel and Karlsruhe establishments.

In this respect an important role can be played by the Geel Establishment through the preparation of chemical standards.

### 3.3. PLANNING

Planning is given for each study in the form of flow-sheets. (see Table E-I-03/j, E-I-03/k and E-I-03/l)

### 3.4. MANPOWER AND COSTS

PROGRAMME : NUCLEAR MATERIALS AND RADIOACTIVE WASTE MANAGEMENT				
PROJECT 3 : FUEL MATERIALS MANAGEMENT				
	1977	1978	1979	1980
RESEARCH STAFF	33	33	33	33
INVESTMENTS (K.U.A.)	30	30	30	30
RUNNING COSTS (K.U.A.)	300	300	300	300
CONTRACTS (K.U.A.)	---	---	---	---

BENCH MARK					
OBJECTIVE: to provide a set of reference data on burn-up, isotopic composition and cross section ratios					
	1976	1977	1978	1979	1980
PRESENT PROGRAMME PLANNING	A. Experimental post-irradiation analysis (PIE)  30 samples Obrigheim	30 samples Trino III	30 samples DOEL I  30 samples BR3 Vulcain	Doel II Doel III	
B. Elaboration of experimental data	Data analysis of experiment PIE				
	Use of burn-up codes. Evaluation of analysis method. Use of unfolding codes.				

TABLE E-I-03/J

<b>ISOTOPE CORRELATIONS</b> <b>OBJECTIVE : to verify the internal consistency of isotopic data from fuel analysis to deduce the amount of specific isotopes from measurements of others</b>					
	1976	1977	1978	1979	1980
<b>PRESENT PROGRAMME PLANNING</b> <b>A. Experimental work on isotope correlations</b>					
	<div style="border: 1px solid black; padding: 5px; margin: 5px;">                     Analysis of fuels from thermal, Pu recycling and fast reactors                 </div>				
	<div style="border: 1px solid black; padding: 5px; margin: 5px;">                     Development of devices for monitoring gaseous fission products                 </div>				
<b>B. Theoretical analysis</b>	<div style="border: 1px solid black; padding: 5px; margin: 5px;">                     Theoretical analysis for thermal reactor fuels (other than PWR), Pu recycling and fast reactor fuel                 </div>				
	<div style="border: 1px solid black; padding: 5px; margin: 5px;">                     Completion of codes for data bank                 </div>				
<b>C. Operation of data bank</b>	<div style="border: 1px solid black; padding: 5px; margin: 5px;">                     Operation of data bank                 </div>				
	<div style="border: 1px solid black; padding: 5px; margin: 5px;">                     Operation of data bank                 </div>				

TABLE E-I-03/k

160

<b>STUDY 3.3 NON DESTRUCTIVE ANALYSIS (NDA)</b> <b>OBJECTIVE : to develop and standardize non-destructive techniques for fuel materials analysis</b>					
	1976	1977	1978	1979	1980
<b>PRESENT PROGRAMME PLANNING</b> A. Developments and practical applications of NDA techniques	Development of practical measuring systems				
	Automation of techniques and data treatment				
B. Standardization of NDA techniques	Study basic concepts and formation of adequate certification body		Proposal of standard methods and reference material		

TABLE E-I-03/1

## 4. PROJECT: STUDIES FOR DECONTAMINATION OF REACTOR COMPONENTS

### 4.1 BACKGROUND

In water cooled power reactor operation, the problems resulting from the accumulation of radioactive corrosion products in primary circuit sections outside the core have grown in function of the power and the number of stations, exposing a considerable number of operational and maintenance personnel to the maximum acceptable radiation dose.

Consequently, the necessity to decontaminate various circuit components increases, if reactor personnel is not to be unduely exposed to ratiation.

When carrying out decontamination of a circuit component, two kinds of risk must be avoided:

- 1) Reduction of the mechanical resistance of the part under treatment due to the dissolving effect of the decontaminating agents
- 2) Hazards due to handling of chemically highly agressive radioactive liquids.

Research activities in that field were strongly recommended by the Advisory Committee of the current four year research programme "Technical Support to Nuclear Power Stations" and also by the ad hoc working group on "Water Chemistry in Power Reactors".

The latter working group was sponsored by the General Directorate III of the Commission (Industrial and Technological Affairs) as platform for exchange of experiece for chemists from nuclear power stations and research centres of the Community.

The details of the JRC actual four years research programme in water chemistry were also determined during the working group meetings, and for the field of decontamination problems the following items were recommended for investigation in the future:

- Contamination mechanisms in high temperature water circuits
- Nature of the contaminating surface layers
- Mechanisms of action of decontaminating agents on surface layers
- Depth of attack by decontaminating chemicals on coupled construction materials of different composition
- Depth of surface attack after repeated contamination-decontamination cycles.

It is foreseen to carry out also these studies in close cooperation with the water chemistry working group, the JRC being charged with its secretariat, thus supporting exchange of experiences in the whole water chemistry field.

### 4.2 TECHNICAL DESCRIPTION

#### 4.2.1. Contamination Mechanisms in High Temperature Water Circuits

Practical experiece in nuclear power plants has shown that active isotopes get to a great part incorporated in strongly adhering films of

surface oxide due to precipitation processes in which particulate and dissolved matter is involved. The influence of water chemistry parameters on the deposition of active isotopes will be studied in a test circuit designed for the actual water chemistry programme, with injection of crud, obtained from previous corrosion product release tests and suitably activated by neutron irradiation. The deposition of the active isotopes in the test section of the circuit will be investigated by radioanalytic techniques.

#### 4.2.2. Nature of Contaminated Surface Layers

This study will be carried out on contaminated samples, exposed in the above test loop (see 4.2.1.) and also on samples prepared from contaminated and dismantled power reactor parts.

A study of the latter type has already been initiated using samples from the nuclear power station of Obrigheim. These samples will be brought to the JRC for metallographic and X-ray analysis during 1976.

#### 4.2.3. Mechanisms of Action of Decontaminants on Surface Layers

Regarding the risks due to handling of radioactive decontamination waste, chemical agents permitting easier waste processing will be selected for tests. Their action on contaminated samples from the above deposition experiments (see 4.2.1.) and nuclear power station samples (see 4.2.2.) will be investigated using X-ray techniques to analyse the changes of chemical and crystallographic composition of the treated surface layers.

#### 4.2.4. Depth of Attack by Decontaminants on Coupled Alloys of different Composition

Samples composed of alloys commonly used in reactor construction (p. ex. AISI type 316 and 410 stainless steel, Inconel 800, Incoloy 600, Stellite, Zircaloy 2, etc.) coupled together in sandwich packs will be contaminated in the test circuit (see 4.2.1.). After decontamination with agents as shown in 4.2.3., the depth of metal consumption will be investigated by metallography.

#### 4.2.5. Depth of Surface Attack after Repeated Contamination - Decontamination cycles

Test samples of single and coupled materials (see 4.2.4.) will be exposed to repeated cycles of contamination followed by decontamination and the depth of the various attacks will be revealed by metallographic techniques.

### 4.3. MANPOWER AND COSTS

#### PROGRAMME: NUCLEAR MATERIALS AND RADIOACTIVE WASTE MANAGEMENT

##### PROJECT 4 : Studies for Decontamination of Reactor Components

	1977	1978	1979	1980
Research staff	10	10	10	10
Investments (KUA)	30	10		
Running costs (KUA)	40	40	40	40
Total (KUA)	70	50	40	40



ADVISORY COMMITTEE  
ON PROGRAMME MANAGEMENT  
"WASTE DISPOSAL"

"OPINION"

of the ACPM - Waste Disposal on the J.R.C. programme proposals 1977-1980

The JRC proposals for a programme Waste Disposal (1977-1980), reported in the document EUR/C-IS/767/75, have been discussed during the meeting of the ACPM (direct action) held at Ispra on October 1-2, 1975 and during the meeting of the ACPM (direct and indirect actions) held at Brussels on November 27-28, 1975.

On the basis of the recommendations expressed by the delegates a new version of the Proposals has been prepared, and it has been included in the document CCG-167 (February 1976) as part of more general programme "Nuclear Materials and Radioactive Waste Management".

The Ispra proposals are divided in two projects which are subdivided in seven actions :

Project 1. The evaluation of long term hazard of radioactive waste disposal

- Waste hazard analysis
- Long term stability of conditioned waste
- Interaction of actinides with environment
- Actinides monitoring

Project 2. Chemical separation and nuclear transmutation of actinides

- Chemical separation of actinides
- Assessment studies on/and nuclear data for actinides transmutation
- Cross section measurements.

The Committee, during the meeting held at Brussels on March 9-10, 1976, has expressed the following opinion on the proposals reported in the document CCG-167.

- The Committee agrees on the orientation of the programme
- The Committee considers that the manpower effort is adequate for the realization of this programme.
- For what concerns project 1 the Committee attaches a great importance to the actions "Waste hazard analysis" and "Interaction of actinides with environment", also taking into account their importance in relation with the information of the public opinion.  
In the action "Long term stability of conditioned waste" the work should be concentrated on the aspects which are inherent to the development of the hazard model.
- The Committee considers the project 2 as especially suitable for a Community action, due to the character of long-term research. The project should not only deal with the feasibility of the concept but also the technical implications of more complex fuel cycle and its safety should be studied.  
The Committee attaches importance to the chemical separation problems, which may be a prerequisite for alternative waste management systems for actinides.
- Within the framework of this action the Committee draws the attention of the Commission to the need for harmonizing these programmes with those carried out in the Member States.

4. SOLAR ENERGY

PROGRAMME  
SOLAR ENERGY

TABLE OF CONTENTS

INTRODUCTION

1. PROJECT : HABITAT AND THERMAL CONVERSION

1.1. BACKGROUND

1.2. TECHNICAL DESCRIPTION

1.2.1. European Standardized Pilot Test Facility for the Determination of Solar Collector Performances

1.2.1.1. Collection of Solar Data and Analysis Methods

1.2.1.2. Standard Test Methods for determining Thermal Performances of Solar Collectors

1.2.2. R & D on High Efficiency Collectors, Storage and Cooling Subsystems

1.2.2.1. High Efficiency Collectors

1.2.2.2. Energy Storage

1.2.2.3. Study of Cooling Subsystems Using Absorption Cycles

1.2.3. Experimental Studies on Combined Heating, Cooling and Storage Systems

1.2.4. Applied Materials Research for Habitat

1.2.4.1. Development and Amelioration of Surfaces of Controlled Spectral Absorbance

1.2.4.2. Measurement of the Optical Properties of Selective Surfaces

1.2.4.3. Basic Optical Properties of Materials

1.2.4.4. Field Tests

1.2.5. Distillation

1.2.5.1. Ethanol Distillation

1.2.5.2. Seawater Distillation

1.2.6. Applied Materials Research for High Temperature Conversion

1.2.6.1. Heat Transport and Storage by Organic Liquids

1.2.6.2. High Temperature Absorber Surfaces

1.2.7. Technoeconomical Studies

1.2.7.1. Cost Evaluations of Solar Heating Components and Systems

1.2.7.2. Determination of Optimum Solar Energy Load in Systems

1.2.7.3. European Information Retrieval Centre for Solar Habitat

1.3. PLANNING

1.4. MANPOWER AND COSTS

1.5. CONNECTION WITH INDIRECT ACTIONS

1.6. REFERENCES

2. PROJECT : EUROPEAN SOLAR IRRADIATION FACILITY

2.1. BACKGROUND

2.2. TECHNICAL DESCRIPTION

2.2.1. Objectives

2.2.2. Preliminary Description

2.2.3. Operation

2.3. PLANNING

2.4. MANPOWER AND COSTS

2.5. CONNECTION WITH INDIRECT ACTIONS

3. PROJECT: ORIENTATIVE STUDIES

3.1. INTRODUCTION

3.2. TECHNICAL DESCRIPTION

3.2.1. Direct Conversion

3.2.1.1. Electrochemical Solar Cells Based on Semi-Conductor/Electrolyte-Electrodes

3.2.1.2. Bioconversion of Solar Energy

3.3. PLANNING

3.4. MANPOWER AND COSTS

3.5. CONNECTION WITH INDIRECT ACTIONS

3.6. REFERENCES

PROGRAMME

SOLAR ENERGY

INTRODUCTION

The Solar Energy programme has been intentionally limited to three Projects in order to concentrate the efforts of the J.R.C. in this field.

- The first deals with the Thermal Conversion of Solar Energy in particular for housing, a project of quasi immediate usefulness, in which the J.R.C. has already acquired a well established competence: in fact the indirect action programme on Solar Energy R & D has called upon the J.R.C. for defining its first activities on this field.
- The second project conceives the construction and operation of an European Solar Irradiation Facility to provide a central laboratory equiped for testing solar energy systems on behalf of industry and other institutions in the E.E.C.
- The third field, called Orientative Studies, deals with research activities of a more basic and exploratory character, possibly leading, in the mid term, to other practical applications of Solar Energy.

SUMMARY OF MANPOWER AND COSTS

PROGRAMME: SOLAR ENERGY							
	Research Staff (per year)	Investments (MUA)	Total Running Expenditures (MUA)	Resources (MUA)	Required Budget (MUA)	Expected Income (MUA)	
<u>PROJECT 1</u> HABITAT AND THERMAL CONVERSION	15	0.50	0.82		1.32		
<u>PROJECT 2</u> EUROPEAN SOLAR IRRADIATION FACILITY	16	2.00	1.20		3.20		
<u>PROJECT 3</u> ORIENTATIVE STUDIES	4	0.06	0.28		0.34		
T O T A L S	35	2.56	2.30		4.86		

Table E-I-04/a



## 1. PROJECT : HABITAT AND THERMAL CONVERSION

### 1.1. BACKGROUND

The use of solar energy as an alternative energy source, has received increased attention in the last few years as a result of the oil crisis and the general world energy situation. It has been the object of excessive press coverage, to the point that it might have blurred the general public view as to what are the real possibilities of solar energy in our economy.

It is considered now that the first assessments (for instance, the conclusions of the 1975 Panel organized by NSF and HASA) were too optimistic (1).

A reasonable evaluation would fix, for the end of the century, at a few percents, probably not greater than 5%, the overall contribution of solar energy, if well funded aggressive programmes are carried out. Most of it would be obtained by low temperature thermal conversion of solar energy and the main field of application would be the habitat which now accounts for about one third of total energy consumption.

However modest these values may seem, one must be aware of their implications. In the period 1985-1990, a 1% total saving by solar energy implies that 10 to 20% of all new houses from now on are constructed with solar energy systems, a tremendous urban task.

By another estimate, this 1% saving would mean for the Community for the next 10 years, an average yearly investment in solar systems of the order of 300 to 650 million Accounting Units.

- 1.1.1. The three main applications of solar energy in housing concern the production of hot domestic water, heating and cooling. In some parts of the world, such as Florida, Israel, Japan, the production of hot domestic water by solar collectors has already shown to be competitive.

The problems related to heating have mainly been studied in so-called solar houses. (TROMBE-MICHEL houses in France, PHILIPS house in Germany, BOUW CENTRUM house in the Netherlands, the ZERO ENERGY house in Denmark, etc. (2,3).

One of the main reasons why solar heating is not yet competitive, lies in the crucial energy storage problem. Because of unavailable economic storage systems, conventional heating systems must be in any case installed and able to face 100% load, leading to overall high investment costs.

Moreover, the price of solar collectors must be reduced and the whole integrated systems optimized with great care, taking into account the

whole house energy balance (insulation, windows, etc.).

The mass production of low cost solar collectors (let us say about \$ 50 per square meter) will be one of the other decisive factors in proving the competitiveness of solar energy. Big European industrial groups are showing great interest but they are proceeding with care as they are not yet sure of the potential market.

Ordinary solar collectors (50% efficiency at 50° C) are already being marketed by small industrial firms, sometimes at inflated prices, announcing inflated performances in a field where norms are urgently needed. A disillusionized public could be drawn away from their present interest.

High performance collectors (50% efficiency at 100° C) are still in the experimentation phase. PHILIPS is experimenting with evacuated glass collectors (4); the JRC-Ispra in collaboration with CEA and Prof. FRANCLIA is experimenting with selective surfaces and FRANCLIA-structure collectors. DORNIER in Germany is working on high temperature selective surfaces.

- 1.1.2. The United States are setting up a "National Plan for Solar Heating and Cooling". An interim report (5) was prepared by ERDA which covers all the problems of organization related to such a plan. By 1985 there would be 596,000 housing starts, 55,000 commercial starts, 13,000 commercial retrofits using solar energy leading to a total annual fuel saving of 36,000,000 barrels of oil equivalent energy.

In Germany, a document from the "Bundesminister für Forschung und Technologie", entitled "Sonnenenergienutzung auch in der Bundesrepublik möglich", outlines German activities (6).

The R & D budget is about 22 million marks per year from 1975 to 1979 with activities based mainly on low temperature thermal conversion.

France, probably being the country in Europe who initially invested the most in solar energy, has adopted recently a more "wait and see" attitude, maybe fearing that undue hopes or an excess of enthusiasm for solar energy might be generated. The different solar activities divided among EDF, CNRS, CEA are being co-ordinated.

The Netherlands are pursuing a policy of using solar energy in low cost dwellings where government incentives can be introduced.

Italy, being the country who could benefit the most from solar energy use, is planning some demonstration units and is dividing funds among various institutes and research centres.

- 1.1.3. It is doubtful whether in the near future a significant penetration of solar energy use in habitat can be expected by simple economic motivation.

All economic studies conclude that, at the present time, solar heating is more expensive than other (conventional) heating sources such as fuel, coal, gas and even electricity.

But just as for nuclear energy, 20 years ago, it is strongly felt that the reduction of cost of solar devices, the increase of their performances within technological expectations and the demonstration of long-term reliability of complete solar systems, could bring the break-even point within 10 years, on the assumption of an average yearly increase of 1 to 2% for conventional energy.

This process could be accelerated by government incentives such as tax reductions or cheap loans for the installation of solar systems as is already the case in Denmark.

The JRC, which in the framework of its present solar energy programme, has already acquired a good competence in such fields as solar data collection, high performance collector development, research and measuring techniques for selective surfaces and system study, can make a significant contribution to the setting up of an adequate European technology for solar applications in housing.

Moreover, there is an urgent need for standard test methods for the determination of the thermal performance of solar collectors and/or complete systems. This need is not only essential from the point of view of house-building requirements, but also for the regulation of international commerce in solar devices where competition might become severe. The Commission, already having acquired such experience in its BCR activities, is in a position to provide the technological and administrative infrastructure necessary to perform such a task.

A third aspect which will play an important role as well, is what could be called the penetration strategy of solar energy in our society through :

- General collection of data,
- Education programmes,
- Dissemination of information,
- Organization of encounters between industry, architects, building agencies, etc.

The JRC could make an important contribution to this social aspect which can be defined as being of general European interest.

## 1.2. TECHNICAL DESCRIPTION

The following activities are proposed.

### 1.2.1. European Standardized Pilot-Test Facility for the Determination of Solar Collector Performances

This activity is divided into two main parts :

- Collection of solar data and specific data analysis methods for solar collector performances;
- Setting up of standard measuring techniques and procedures for the calculation of collectors thermal output.

#### 1.2.1.1. Collection of Solar Data and Analysis Methods

In most European meteorological centres, solar data, generally presented in the form of G.S.R. (global solar radiation) on a horizontal plane and D.S.R. (diffuse solar radiation) is inadequate for predicting solar collectors performance in a given location at a given inclination.

The use of average solar energy available, for example for a month, to estimate the average performance of a process, is unsatisfactory because the performance of many processes is not linear with solar radiation and the use of averages in these cases may lead to serious errors. So proper data storage and accepted correlation for respective percentages of diffuse and direct radiation are necessary.

The following points should be studied in close collaboration with indirect actions in this field.

- a) Data analysis for correlation between monthly average daily diffused light to monthly average cloudiness index. Some interesting work has been done by Liu and Jordan (7) and Connaughton (8) from Ireland. But simple linear regressions in this field were found not to be fully satisfactory. More sophisticated analyses such as non-linear regressions, should be attempted.
- b) Correlations to determine the incident energy on a plane at a given inclination at a given time in a given region. Determination of optimum collector inclination (monthly, half yearly and yearly optimum).
- c) Similar correlations to be defined in the case of low concentration devices (concentration factor (5)) to be used for high temperature collectors.
- d) Study of the dispersion of solar measurements in a given region, due to microclimatic effects. Determination of the optimum number of measuring stations.

It is not foreseen to become involved in the definition of standard apparatus, as this work is being performed in the framework of the World Meteorological Organization.

Part of the proposed studies will have connections with the indirect actions on proposed European network for solar data.

Solar data have been collected at the J.R.C. intensively during the last two years in the framework of activities on concentration devices and a meteorological laboratory exists which could also participate in this activity.

#### 1.2.1.2. Standard Test Methods for Determining Thermal Performances of Solar Collectors

It is proposed to define in a concerted European action a standard method for the measurement of solar collectors with thermal output (9), by determining :

- A reference loop
- Measurement techniques and standards for various temperature measurements,
- Mass flow measurements,
- Types of flow (laminar/turbulent),
- Stabilization periods,
- Precision of various apparatus and calibration standards,
- Acceptable insolation condition (percentage of diffuse light, cloud perturbations),
- Possibility of using solar simulators for reference measurements.

A test facility (5 loops) has been operating at the JRC during the last year, which can be transformed into a standard pilot test facility. A solar simulator is operative at the JRC and the possibility of its use for standard measurements has to be investigated.

These test facilities have made it possible for the JRC to contribute significant technological support to industry as far as solar collectors are concerned. It has generated fruitful collaboration for R & D on high performance collectors with different firms and industries.

#### 1.2.2. R & D on High Efficiency Collectors, Storage and Cooling Subsystems

##### 1.2.2.1. High Efficiency Collectors

High efficiency collectors would make it possible to reduce storage volumes as far as heating and the production of hot domestic water are concerned, and would enable solar energy to be used in cooling and climatization with absorption cycles where temperatures of about 100° C are necessary, in order to obtain acceptable cycle efficiencies.

Higher efficiencies of collectors would also compensate for the modest insolation levels of Northern Europe and of course in other fields such as solar pumps, distillation, etc., they open a whole new set of possibilities.

This type of collector is still in the stage of optimization. They have not yet reached the stage of industrial production, either because they are too costly or because their long-term reliability has not been demonstrated.

Proposed studies will essentially concentrate on the problem of the reduction of heat losses in solar collectors by radiation and natural convection.

The following solutions are being investigated and tested in the framework of collaboration contracts with industry:

- Selective surfaces,
- Honeycomb or FRANCIA-structures,
- Corrugations,
- Vacuum.

In certain cases some of these solutions can also be combined together.

It can also be of interest to investigate the possibility of using low price crude heat pipe systems. Another solution concerns the use of fixed low concentration devices, connected to collectors. This field might be of particular interest for cooling problems.

R & D on high efficiency collectors has been one of the main activities in thermal conversion at the JRC. This work has been carried out in close collaboration with various European firms or institutes (CEA, Prof. FRANCIA University of Genova, Alumetal, etc.).

#### 1.2.2.2. Energy Storage

Storage constitutes the main limitation for solar energy applications in housing. It is reasonable to assume that the storage of 250,000 Kcal would be a "yardstick" to consider for winter heating applications (10) with an acceptable cost of \$ 1,000 to \$ 1,400.

Storage materials can accumulate thermal energy as specific heat (sensible) or as heat of fusion (latent), including their combined effects. It is proposed to assess from a technological and economical point of view the convenience of different thermal storage media, such as salt hydrates, paraffines and eutectics.

This assessment will lead to the selection of two materials which would then be systematically tested as far as stability, corrosion,

nucleation, supercooling and heat exchange aspects are concerned.

Container materials such as plastics would be tried, concerning reliability and heat exchange characteristics.

Study of stratification hydrodynamics in water storage tanks, in order to optimize hot water availability, will lead to better efficiencies.

### 1.2.2.3. Study of Cooling Subsystems Using Absorption Cycles

Cooling by solar energy represents a field which is becoming the object of great attention. One of its main advantages over heating is that the need for cooling is in phase with solar energy availability. In the U.S. more energy is spent on the cooling of buildings than on heating. In Europe the situation is somewhat different, but there exists a large potential field of applications for commercial and administrative buildings, schools, hospitals, etc. in Southern Europe.

The field of interest could become even larger in the third world countries with hot climate, where the conservation of food and medicines is a crucial problem.

Solar cooling is in an early state of development with very little activity going on in Europe.

Among the different absorbent-refrigerant combinations that have been tried, the most successful are water/ammonia and lithium bromide/water (11). Because of higher working temperatures (125° C) for ammonia cycles, the lithium bromide cycle, which can work satisfactorily at 95° C is the most recommended one. Coefficients of performance (C.O.P) of the order of .75 can be expected.

The proposed activity would consist in the setting up of a sub-system of lithium bromide absorption machine connected to high efficiency collectors, in order to study all problems related to performance, control, intermittence and influence of generator and condensor temperatures.

A lithium bromide absorption machine has been bought and collectors developed in our laboratories will be available.

### 1.2.3. Experimental Studies on Combined Heating, Cooling and Storage Systems

The study of complete systems is essential for the evaluation of overall performances and more specifically for the calculation of the percentage of energy load that can be covered by solar energy in housing.

The different technological choices (type and orientation of collectors, air or water heating, forced or thermosyphon convection, etc.) can only

be made after testing and studying carefully the interaction between different sub-systems. Optimum working conditions defined for sub-systems do not often coincide with the optimum of the complete system.

Moreover, the demonstration of the technological reliability of complete systems with a careful analysis of all costs involved, will represent an important aspect of a penetration strategy for solar energy in this field.

The study of whole systems involving heating, cooling and storage should become one of the main points of the programme.

It is proposed to set up a flexible test facility where a whole set of different types of systems can be tested and optimized and where components can easily be changed, and not duplicate "solar houses", where systems are fixed and where strict building considerations play an important role.

It should be noted that such system studies which look for the optimum use of collectors, heating in winter, cooling in summer, are aiming at applications for big commercial and public buildings, such as schools and hospitals where government incentives could be applied more easily than for private houses.

The construction of such a test facility is starting at the JRC. Its main characteristics are :

- Space for heating or cooling :  $500 \text{ m}^3$
- $70 \text{ m}^2$  of solar collectors on a wall, facing South
- $100 \text{ m}^2$  of solar collectors on the roof with variable orientations,
- $50 \text{ m}^3$  available for storage studies,
- Average heat transmission coefficient :  $0.25 \text{ Kcal/m}^2 \text{ h}^\circ \text{ C}$ ,
- Possibility of heating and cooling, either by water or air systems.

The main aims of this facility are :

- Performance of different types of collectors,
- Study on different types of storage systems,
- Study on cooling systems,
- Control and regulation problems,
- Circuit components, such as heating exchangers,
- Heat pump systems,
- Space energy balances,
- Performances of complete systems.



It is felt that such a test facility, first as a technological tool and second as a demonstration unit, could be of great interest to industry, architects, building institutes, and even can be used for some normative activities.

#### 1.2.4. Applied Materials Research for Habitat

The goals of materials research in the field of solar energy is to provide a selection of characterized, field-tested materials compatible with solar heating and cooling requirements. The high performance design concepts of solar collectors have indicated the need for research in the material optical properties and their characterization.

The low collection efficiency of ordinary solar collectors at high temperatures can be substantially improved by the use of selective surfaces, i.e. surfaces which present an elevated absorption for the solar spectrum (0.3  $\mu$ m to about 3  $\mu$ m) and a low emissivity in the infrared range (3  $\mu$ m to about 20  $\mu$ m). These surfaces are generally realized by depositing a semi-conductor on a reflective base. Several practical selective surfaces have been proposed according to this scheme : CuO on Cu, ZnS on Zn, etc.. But most of them have an important drawback : part of the radiation is reflected at the air-semi conductor interface; this fact reduces seriously the absorption of the collector and the advantage of the reduced infrared radiation losses is offset by the reduced energy collection in the visible range. The development of the selective surfaces with better absorption characteristics in the visible range, is the main object of the present research proposal. The experience in the Materials Division with industrial deposition techniques will be very helpful.

The proposed actions are :

##### 1.2.4.1. Development and Amelioration of Surfaces of Controlled Spectral Absorbance

- a) The development of simple selective surfaces usable up to about 100° C by methods which lend themselves to large scale industrial production, such as chemical and galvanic treatment, varnish, etc., is proposed. Several systems on a semi-conductor base will be examined. After initial screening it is planned to synthesize more sophisticated systems, i.e. destructive interference will be used to enhance absorption in the visible spectrum and later on achromatization will be tried.
- b) Selective surfaces usable up to about 150° C are proposed for use in conjunction with absorption cooling units. In this case more expensive deposition techniques will be considered.
- c) Development of negative selective surfaces.

#### 1.2.4.2 Measurement of the Optical Properties of Selective Surfaces

- a) Standardization and measurement of the absorption of a surface for solar energy,
- b) Measurement of the total hemispherical emittance in the infra-red region.

#### 1.2.4.3 Basic Optical Properties of Materials

Measurement of the refraction index and the extinction coefficient of optical materials.

#### 1.2.4.4 Field Tests

The optical properties of materials are often surface properties and as a consequence very susceptible to deterioration by light, oxidation, corrosion and water diffusion within the base material.

In order to evaluate the performance of these materials, components should be exposed during extended periods to realistic conditions (life time tests) of temperature, light, moisture, etc.

Typical short-term tests under extreme conditions should be devised in order to be able to predict life-time of components and systems.

#### 1.2.5 Distillation

The techniques for distillation are at present largely applied on industrial scale; considerable fuel savings can be obtained by the use of solar energy. Here, profit could be made of the spin-off from collector development in habitat.

##### 1.2.5.1 Ethanol Distillation

Ethanol, which in future might be used as a fuel, may be produced by fermentation of vegetable matter, such as straw, melasses and sugar beets. Particularly promising are plants suitable for ethanol production, which grow on arid soil, unfit for other agricultural production. Yields of 5000 l/ha.yr might be expected. The advantages of the use of solar energy are:

- fuel savings,
- distillation on site.

From a preliminary study made at the JRC (12) results that 2.5 kg/h of 95% ethanol can be produced with a collector surface of 10 m<sup>2</sup>. Further assessment studies aimed at the evaluation of overall effi-

ciency will be carried out mainly by contracts.

#### 1.2.5.2 Seawater Distillation

Flat collectors have already been extensively used for seawater desalination. Field tests have demonstrated that solar stills can operate satisfactorily for long periods with minimum maintenance, but they have the following drawbacks:

- large surface of collector per m<sup>3</sup> water produced,
- no possibility for economy of scale.

The first drawback can be overcome when solar collectors are used, together with multistage distillation where 90% of the condensation heat is recuperated, thus requiring only 10% of the collector surface required for a solar still.

For these applications the high performance collectors developed in the framework of the Habitat, producing energy at 80°C, can be of great interest.

Further technical and economical studies on the coupling of collectors to industrialized desalination plants, will be carried out by contracts.

#### 1.2.6 Applied Materials Research for High Temperature Conversion

A considerable part of the energy consumption is used at temperatures much higher than 80°C obtainable with normal solar collectors e.g. electricity production, process steam in industry, etc.

In those countries which generally do not have an extensive electricity network and where oil is expensive, especially in remote areas, solar electricity production could already now play an important role. Solar power plants, however, have a fluctuating solar energy supply (day and night, weather conditions, etc.).

A large-scale application in future will therefore depend on the availability of cheap energy storage facilities. In chapter 1.2.6.1 a proposition of high temperature energy storage with organic liquids, will be discussed.

Another important factor is the efficiency with which concentrated solar irradiation can be converted into high temperature energy. This depends largely on the absorption of the receiving surface of the collector. Means to improve this absorption are proposed in chapter 1.2.6.2.

### 1.2.6.1 Heat Transport and Storage by Organic Liquids

Organic substances and in particular terphenyls might be interesting, both for heat storage and heat transport at temperatures between 300°C and 400°C.

Mixtures of biphenyl and terphenyl, studied extensively in Ispra in the framework of the organic cooled reactor Orgel, have the following general characteristics:

- Due to the high boiling point (approx. 360°C), storage of energy at high temperatures is possible and this feature renders it attractive as a storage medium (e. g. for solar power plants). The high boiling point makes terphenyl also a suitable transport medium for heat at high temperatures.
- Energy is stored as specific heat and a temperature increase of 300°C (100°C to 400°C) gives terphenyl mixtures a heat capacity of 150,000 Kcal/m<sup>3</sup> at atmospheric pressure. This is of the same order as pressurized water at 250°C with a pressure of 40 kg/cm<sup>2</sup>. In order to store the output of a 3 MW<sub>th</sub> solar power plant during 10 h, a well-isolated volume of 170 m<sup>3</sup> would be required.
- A terphenyl mixture is a reasonably good heat transport medium as far as heat transfer and heat conduction properties are concerned. The heat exchangers in the storage tank for charging or discharging heat have to be relatively large; this increases the cost of the storage installation.
- Up to 400°C the danger of fouling the tubes and container is practically non-existing.  
Terphenyl mixtures have been used satisfactorily for 10 years as a coolant in a Canadian reactor under very stringent conditions (pyrolysis at 400°C and irradiation).
- The cost of terphenyl is rather high:  
170 m<sup>3</sup> terphenyl, required to store 30 MW<sub>th</sub>, would cost approximately \$ 200,000.

## Proposed Research

Research in this field will be focused on the application of terphenyl as a transport and storage medium at high temperatures.

- With these applications in mind, a terphenyl mixture must be chosen which meets requirements such as high heat transfer and heat conduction values; liquidity at room temperature, etc.
- The research on terphenyl as a transport medium will be closely linked with the development of solar collectors functioning at temperatures around  $400^{\circ}\text{C}$ . The heat transfer to terphenyl in this type of collectors has to be optimized. For this purpose the shape of the collector is very important.

Collaboration will be sought with laboratories which have already experience with the design of high temperature collectors.

The improvement of the absorption of solar irradiation in high temperature collectors will be the subject of the study proposed in chapter 1.2.6.2.

- For the application of terphenyl as a storage medium, it is proposed to design and construct a small well-isolated terphenyl storage tank of about  $20\text{ m}^3$ . The performance of this storage tank should be optimized. In this way insight can be gained concerning the efficiency of the energy storage and its economical feasibility.
- Storage of heat with water-steam under pressure is well established, but has the disadvantage of delivering saturated vapour at relatively low temperatures ( $250^{\circ}\text{C}$  at  $40\text{ kg/cm}^2$ ). This drawback might be reduced when we use terphenyl and water-steam storage simultaneously. We therefore propose to study a combined terphenyl and water-steam storage, where terphenyl transports the heat from the high temperature collector to the water-steam and terphenyl heat storage tanks, and where steam at  $250^{\circ}\text{C}$  from the water-steam container is passing the terphenyl storage tank for superheating up to  $400^{\circ}\text{C}$ .

In this context other means of high temperature storage might be studied, in particular chemical storage utilizing the large experience the JRC has acquired with thermochemical reactions for hydrogen production.

#### 1.2.6.2 High Temperature Absorber Surfaces

The receiver of a thermodynamic solar power plant needs an elevated absorption surface for solar radiation. Normal metallic surfaces (stainless steel) have too elevated a reflectivity for radiation in this spectral region.

Our pluriannual experience in the field of dendritic structures and fibres offers the basis for an original solution of the problem: as pointed out by Cuomo et al., rather than absorb solar light directly using intrinsically highly absorptive (in the solar wavelengths) materials for the surface, a microstructure, similar in geometry to an acoustic anechoic surface be used. The surface would consist of a dense forest of aligned needles whose diameters are of the order of visible wavelengths; the spacing between needles is several wavelengths. This surface would absorb with high efficiency, because of multiple reflections as the incident photons penetrate the needle maze (this is similar to the acoustic absorption by anechoic walls). Since absorption is dominated by geometric factors, the surface of the structure can be made of a material which emits poorly in the infrared (blackbody temperature of 550°C). We hypothesize that such a material would have an absorptivity of unity for most wavelengths smaller than the needle spacing over a narrow incident cone about the needle direction. However, this high absorption cone, which will have high emissivity, will not greatly affect the total hemispherical emissivity because of its small solid angle. If the surface is made of a metal with low emissivity, the total hemispherical emissivity may not significantly increase above the normal emissivity of the metal.

#### Proposed Research

- A first experimental technique for obtaining a well aligned distribution of dendrites has already been set up for a quaternary Ni-based alloy. The proposed work is to optimize the chemistry of the alloy and the solidification conditions in order to achieve a better control of the morphological parameters such as dendritic spacing, secondary arm spacing and so on, which determine the absorption.

To this purpose two main activities are envisaged; the first one dealing with the fundamentals of dendritic solidification and the

second one aimed to transfer the existing know-how to a geometry suitable for solar collectors.

A second experimental technique for preparing surfaces of variable absorption results from our experience on metallic vapour disposition. Depending on the conditions of the evaporation (substrate temperature evaporation velocity, gas atmosphere) and on the metal used, the structure of the deposit can be varied strongly.

- The characterization of the metallic surface will be made principally by two techniques: scanning electron microscope and X-ray diffraction. The first technique is useful in order to observe the topography of dendrites and to study the growth mechanisms. The second technique permits to determine the nature and the crystallographic orientation of the dendrite network.
- The basic measurements (absorption) will be done in the framework of the applied materials research activities proposed in "habitat".

#### 1.2.7 Techno-economical Studies

Reliable systems must be optimized economically in relation to production costs and climatic environment. Due to the large amount of data which will be available in the Community in the near future, it is recommended that a well organized group of the JRC tackles the different aspects of techno-economical evaluations.

##### 1.2.7.1 Cost Evaluations of Solar Heating Components and Systems

It is proposed to set up the models which will make it possible to effect economic comparison between different types of systems with tentative projection into the future as far as mass production is concerned and reducing costs by technological improvements.

##### 1.2.7.2 Determination of Optimum Solar Energy Load in Systems

For our latitudes, it will be necessary to determine the optimum distribution between contributions of solar energy and of conventional energy sources. It is felt that the optimum is roughly round 60% solar energy contribution. But these values of course will vary with different regions and different types of systems involved.

It is proposed to study mathematical models using as input climatic conditions and costs of systems and components. Models, such as studied by LOF (USA) would be applied to determine for three or four representative regions in Europe the optimum systems and their optimum working conditions.

### 1.2.7.3 European Information Retrieval Centre for Solar Habitat

Studies on solar houses, solar collectors and related equipment have been started in many places in the world, e.g. in USA, Japan and within the Community. Prototypes are under construction on a laboratory scale. There seems to be an urgent need to collect data and other information in a central place and make it available to interested persons.

The JRC-Ispra has favourable conditions to take an initiative in this field. Specialists on solar habitat, data banks and retrieval systems are available. It is therefore proposed to create a European information retrieval centre for solar habitat. This centre will provide engineers, architects and industry managers with the existing state of the art and help to avoid the situation where each small laboratory and company is "inventing" things which are available already.

### 1.3 PLANNING

TABLE E-I-04/b

SOLAR ENERGY PROJECT 1: HABITAT AND THERMAL CONVERSION				
PLANNING	1977	1978	1979	1980
<u>1. Standard Test Facility</u>				
- mounting and start up				
- operation				
- standard operation				
<u>2. High Efficiency Collectors</u>				
- R&D				
- Industrial support				
<u>Energy Storage</u>				
- selection of storage media				
- field tests				
- subsystems studies				
<u>Absorption Cooling</u>				
- performance of cooling machine				
- subsystem				
<u>3. Combined Systems</u>				
- mounting				
- testing				



(table continued:)

PLANNING	1977	1978	1979	1980
<b>4. <u>Applied Materials Research</u></b>				
<u>Measurement</u>				
- mounting				
- operation				
<u>Selective Surfaces</u>				
- development				
- testing				
<b>5. <u>Distillation</u></b>				
<b>6. <u>Materials for High Temperature Conversion</u></b>				

**1.4 MANPOWER AND COSTS****TABLE E-I-04/c**

PROGRAMME: SOLAR ENERGY				
PROJECT 1: HABITAT AND THERMAL CONVERSION				
	1977	1978	1979	1980
RESEARCH STAFF	15	15	15	15
-----				
INVESTMENTS (KUA)	240	130	70	60
-----				
RUNNING COSTS (KUA)	130	130	130	130
-----				
CONTRACTS (KUA)	----- 300 -----			

**1.5 CONNECTIONS WITH INDIRECT ACTIONS**

In August 1975 the Council of Ministers decided upon an indirect action in the field of energy, in which 17.5 MUA will be spent in four years on solar energy. In the framework of this indirect solar energy programme, several working groups have been created, one of which deals specifically with solar applications in housing.

The JRC is chairing this group.

The structure of our present proposal on habitat has been defined in such a way as to offer the maximum support to the indirect action, either by offering "services" which should lead to European reference methods for testing and measuring, or by setting up facilities which will be at the disposal of laboratories and industries.

Moreover, this programme foresees participation in specific housing joint ventures.

A complete coordination of the Communities' effort on solar energy will be ensured by the Advisory Committee common to the direct and indirect actions.

#### 1.6 REFERENCES

- (1) NSF/NASA Solar Energy Panel; "Solar Energy as a National Energy Resource", Dec. (1972)
- (2) J. M. VAN HEEL, Bouwcentrum; "Nota experimentele woningbouw met laag energieverbruik voor verwarming, ventilatie en warmwatervoorziening", April (1975)
- (3) V. KORSGAARD et al., Technical University of Denmark; "The Solar Heating System in the Zero-Energy House in Denmark"
- (4) H. HOERSTER et al., Philips Forschungslab. Aachen, Germany; "High Efficiency Solar Collectors"
- (5) Energy Research and Development Administration; "National Plan for Solar Heating and Cooling", March (1973) - ERDA - 23
- (6) Bundesministerium für Forschung und Technologie; "Sonnenenergie auch in der Bundesrepublik möglich", Jan. (1975)
- (7) LIU and JORDAN; Solar Energy, 4 (1960); "The Interrelationship and Characteristic Distribution of Direct Diffuse and Total Solar Radiation"
- (8) M. J. CONNAUGHTON, Department of Transport and Power, Meteorological Service; "Global Solar Radiation Potential Trans- evaporation and Potential Water Deficit in Ireland", (1965)
- (9) Centre for Building Technology, NBS, Washington; "Method of Testing for Rating Solar Collectors"
- (10) Maria TELKES, ASHRAE Annual Meeting; "Storage of Solar Heating/Cooling", June (1974)
- (11) F.H. BRIDGERS, ASHRAE Annual Meeting; "Applying Solar Energy for Cooling and Heating Institutional Buildings", June (1974)
- (12) D. VAN VELZEN; "The Use of Solar Energy for Ethanol Distillation", Internal Report (1975).

## 2. PROJECT: EUROPEAN SOLAR IRRADIATION FACILITY

### 2.1 BACKGROUND

The main problem of solar energy conversion consists in the economical utilization of this energy source. For solar energy installations the input is free, but mainly due to the low incident energy density large capital investments are needed at the beginning. Thus the cost, which is strongly dependent on the expected lifetime of a given system, becomes a decisive factor. Waiting for lifetime results from real time tests could delay considerably the development of this technology; on the other hand a superficial treatment of this problem could be extremely costly, both to users and to industry.

Neglecting this problem might even lead to a serious fall-back of the whole solar energy development within a few years. The reliability of solar systems under the actual operating conditions, which are in many cases also the ones for which degradation effects are most important, is hence a key problem for the technological development in this field.

A more rapid information on the long-term behaviour may be obtained from accelerated tests under the assumption that the integrated irradiation dose, and not the dose rate, is the essential factor. For most inorganic materials this should be a good approximation. Another question is whether such tests should be done outdoor or indoor. The largest installation in the world to do accelerated tests under high irradiation, allowing a reduction of measuring time in the order of 8 to 10, is the Desert Sunshine Exposure Tests Inc. Their test field is located in the Sonorama Desert, north of Phoenix, Arizona and is used by many important industrial companies and by the NASA. There is no similar test site available in Europe. However, even under the ideal conditions of the Arizona desert, one loses of course measuring time during the night and due to a loss of direct light by unfavourable weather.

It is true that indoor measurements have been plagued by the problem to correlate them to actual outside measurements. However, improved technology in constructing both climatic chambers and large size solar simulators of appropriate spectral distribution and intensity should allow to reduce these difficulties. Moreover, the important advantage of reproducible and constant conditions which are available in a carefully designed test system should outweigh any deficiency in correlating data to outside conditions. In an artificial system it will also be possible to produce and reproduce those extreme conditions which will finally force any system to the break-down point and which usually give valuable hints to produce better systems.

A number of tests can of course be done on the individual components, making up the whole solar converter, say on the plastics, paint, contact

material etc., however, many defects would be seen best during performance tests of the converter as a whole. Tests of this kind and simultaneous comparative studies on a number of converters will require a relatively large installation and will be beyond the possibility of most potential producers of such systems. One has also to take into account that due to the initially very limited market, large investments into such test facilities are likely to be uneconomical to any single large company.

Another reason to construct an artificial test station consists also in the importance the export market will have undoubtedly in the development of this new technology, thus the availability of the full weather spectrum at one place and at all seasons will be extremely useful.

The European Communities have started an R&D programme in the field of solar energy under the form of Indirect Actions. Some of these actions could benefit from the existence of a common test station and especially for Action C it might be even necessary to have one. This would allow e. g. to check the progress made during the executions of that programme.

The acceleration of life-time tests will be done by the use of concentrated light. The availability of such light sources has still another advantage: since the economic exploitation of solar energy is seriously influenced by the low energy density of solar radiation, concepts which use concentrating devices may offer substantial economic benefits, this is true both for photoelectric and for thermal systems. For the case of terrestrial solar cells very considerable cost reductions have to be made, this will, if ever possible, require time. At least during that period concentration may be a way to lead to a substantial expansion of the market for photo-electric devices: this again could trigger further investments into this field. Obviously constant high intensity test conditions would be essential to develop this approach.

Finally, a test station which allows to perform measurements under exactly definable conditions, would be of great help in seeking standards for evaluating solar cells, thermal panels or high temperature components, especially if one considers that such evaluations should take account of a large range of possible environmental operating conditions.

## 2.2 TECHNICAL DESCRIPTION

### 2.2.1 Objectives

We propose to develop, in close collaboration with, and for the interested industry, the relevant national and international organizations,

a central solar irradiation station with the following main objectives:

- Accelerated life-time tests of terrestrial photoelectric and thermal converters and of critical components of high intensity solar energy conversion systems.
- Performance tests on terrestrial photoelectric and thermal systems under concentrated sunlight.
- Study of the influence of extreme environmental conditions, including the effects of chemical pollutants, on life-time and performance of solar energy conversion systems and components.
- Development of internationally accepted standardized test procedures for behaviour of solar energy converters under highly concentrated irradiation and extreme climatic conditions.

### 2.2.2 Preliminary Description

In agreement with the recommendations of the General Advisory Committee to the Director General, the final definition of the proposed test station will be made after consultation with the CCMGP and after additional explorative studies. However, for the time being the following base-line design is proposed:

The test station will be composed of three sections:

- A modular collimated light system, consisting of 16 to 32 units of  $1 \text{ m}^2$  with variable spectral composition and a power density of  $1 \text{ kW/m}^2$  (filtered Xenon light). The light units can be coupled to a number of optical concentration devices with various concentration factors and over areas of different shape. Part of the light sources will be adapted for pulsed operation to study light intensity behaviour under low thermal load. Special devices for measurements with concentration factors above 1000 will be provided.
- A modular climatic simulation chamber consisting of at least 5 compartments (each of about  $100 \text{ m}^3$ ) will allow measurements on full size photoelectric and thermal panels (up to  $2 \times 4 \text{ m}^2$  or resp. smaller units) under all, also extreme, weather conditions and at simultaneously high irradiation levels. Provisions for rapid temperature cycling and for large changes in humidity, will be made. The individual compartments will allow the addition of defined amounts of atmospheric contaminants. The possibility to study in addition degradation effects due to wind, rain or sand within a specially designed compartment will be explored.

- The third section will comprise an automatic data acquisition system, equipment for special measuring techniques (e. g. for pulsed operation) and installations for automatic production of data sheets and multi-parametric measuring diagrams.

### 2.2.3 Operation

Three operational teams corresponding to the three sections and working in close cooperation, will be set up.

The first group (6 persons) will be responsible for all problems related to the use of the various light sources and concentration systems\*). This will include performance measurements on photoelectric and thermal systems under various intensities, accelerated life-time measurements and investigation of physical effects at high intensities. This group will also be occupied with verification tests in the framework of Action C of the Indirect Actions programme.

The second group (4 persons) will be in charge of the climatic chamber, of thermal cycling, of corrosion tests, of measurements concerning changes due to photochemical reactions and due to atmospheric contaminants.

In addition, the behaviour under extreme weather conditions with the aim of producing high failure rates will be investigated.

In this group one will also define standard test procedures for different climatic conditions.

The third group (3 persons) will handle all data acquisition and data reduction problems. It will be in charge of preparing data sheets and test reports.

Coordination between the three sections and contact to potential users will be assured by the project management group (3 persons).

---

\*) including the operation of an outdoor reference test facility.

### 2.3 PLANNING

TABLE E-I-04/d.

SOLAR ENERGY PROJECT 2: EUROPEAN SOLAR IRRADIATION FACILITY					
PLANNING	1977	1978	1979	1980	
Definition	[Timeline bar from 1977 to 1978]				
Design	[Timeline bar from 1977 to 1979]				
Construction	[Timeline bar from 1978 to 1980]				
Partial Operation	[Timeline bar from 1979 to 1980]				
Full Operation	[Timeline bar from 1980 to 1981]				

### 2.4 MANPOWER AND COSTS

The following is a rough estimate on costs and personnel of the test station; a more precise definition is to be obtained from a study on contract basis.

TABLE E-I-04 /e

SOLAR ENERGY PROJECT 2: EUROPEAN SOLAR IRRADIATION FACILITY				
PLANNING	1977	1978	1979	1980
RESEARCH STAFF	16	16	16	16
INVESTMENTS (KUA)	600	900	400	100
RUNNING COSTS (KUA)	100	200	300	300
CONTRACTS (KUA)	200	100	-	-

### 2.5 CONNECTIONS WITH INDIRECT ACTIONS

This activity is closely related to the Energy Research and Development Programme in the field of Solar Energy, adopted by the Council of Ministers on August 22nd, 1975 (Official Journal No. L 231, September 2nd, 1975).

### 3. PROJECT: ORIENTATIVE STUDIES

#### 3.1 INTRODUCTION

In the field of orientative studies a limited number of proposals has been so far identified and is presented within the areas of direct conversion. The interest of other promising areas will be investigated and the possible related proposals for research will be submitted to the ACMP.

#### 3.2 TECHNICAL DESCRIPTION

##### 3.2.1 Direct Conversion

Solar radiation is a high quality energy source. In principle it is possible to convert 95% of its energy into useful work; if suitable direct energy conversion methods would be available.

The only way so far of converting on Earth, on a large scale, solar energy directly into electrical energy is the use of solar cells which were developed originally as energy converters for space applications. These solar cells have to satisfy special space conditions as high efficiency/weight ratio and radiation resistance (costs are of minor importance).

To meet these requirements the silicon p-n cell was developed in the past on an industrial scale.

Terrestrial solar energy converters should satisfy other conditions: high energy output, cost ratio and long life-time under terrestrial conditions. Besides, on Earth, other direct conversion techniques such as solar energy conversion into chemical energy would solve the storage problem.

It is proposed to perform research in the context of the following two basic research actions:

- Investigation of electro-chemical solar cells based on semiconductor/electrolyte electrodes. This method is particularly promising in view of its possible use for a direct chemical conversion (water decomposition) and as a hybrid cell.
- Study of the mechanisms of the Bio-conversion of Solar Energy.

Both actions are closely interrelated. The second one is mainly an electro-chemical study due to the fact that nature applies electro-chemical conversion methods.



These two actions will also benefit from the experience of the well-equipped laboratory of Solid State Physics (optical monitoring of thin films, spectral analysis and radiometry, etc.).

### 3.2.1.1 Electro-chemical Solar Cells Based on Semi-Conductor/ Electrolyte Electrodes

The photo-sensitivity of semiconductor/electrolyte electrodes is caused by a space charge layer in the semiconductor at the semiconductor/electrolyte interface similar to a "Schottky barrier" in a diode at the semiconductor/metal interface. The electrolyte has the same function as the metal. The "Fermi-level" of the electrolyte depends on the redox system used and can therefore be adjusted within certain limits. The light absorption takes place in the semiconductor by band-band excitation.

A photo-electrochemical cell is made by insertion of a second electrode in the electrolyte. Water decomposition takes place if the cell potential exceeds the water decomposition potential of 1.23 V.

The theoretical efficiency is equal to that of the corresponding solid state devices. It depends, among other factors, on the band gap energy, which would be best adapted to the solar spectrum, being in the range of 1 to 2 eV.

Semiconductor/electrolyte electrodes have been investigated in the past as a mainly fundamental research. In the meantime they have found some topic application as an analytical tool in electrochemistry. In 1972 for the first time<sup>(5)</sup> a semiconductor/electrolyte cell was proposed for the decomposition of water by sunlight. Later several semiconductor/electrolyte cells were constructed using different semiconductor electrodes. Efficiencies in the percentage range could be reached<sup>(6)</sup>.

The main problems of semiconductor/electrolyte cells seem to be:

- corrosion of the semiconductor electrode by anodic dissolution,
- electrode polarization effects resulting in cell potential losses.

The main advantages of semiconductor/electrolyte cells seem to be:

- their potential to convert directly solar energy in chemically stored energy (e. g. by water decomposition),
- the possibility of using the cells as electrical or chemical and simultaneously as thermal converters with the electrolyte as the heat transfer medium,

- a good chance to use polycrystalline semiconductors<sup>(7)</sup> (a quantum conversion efficiency of 85% with a TiO<sub>2</sub>/electrolyte electrode has been observed<sup>(8)</sup>),
- a simple construction technique and accordingly probably low production costs.

There is a gap in most national research activities in the European states concerning the development of photo-electrochemical cells of the proposed type. This gap could be filled by a JRC action in this field.

Research on photo-electrochemical cells is of an interdisciplinary type involving in particular semiconductor physics, electrochemistry, organic and inorganic chemistry, metallurgy and electron-microscopy. All these disciplines are present and well-equipped at the JRC-Ispra.

In view of an eventual use of the photo-electrochemical cells for a photo-assisted water decomposition, the existence of the JRC Hydrogen Programme would allow a close cooperation and exchange of experience.

The Solar Energy group of the JRC-Ispra has acquired in the last two years a good experience in the field of semiconductor/electrolyte cells<sup>(8, 9)</sup>. The most important basic equipment for the experimental investigations is available.

#### Technical Description

- a) Investigations related to the problem of anodic dissolution of the semiconductor electrode:
  - systematic analysis of different classes of semiconductors (with special attention to metaloxide semiconductors) with respect to their corrosion behaviour. The scope is to find a stable semiconductor such as TiO<sub>2</sub> which however should have a band-gap more appropriate to the solar spectrum (1-2 eV).
  - investigation of the possibility of protecting the semiconductor by very thin noble metal coatings according to a recently proposed procedure of Tsubomura et al.<sup>(10)</sup>.
- b) Study of sensitization techniques of semiconductor/electrolyte electrodes by dyes dissolved in the electrolyte with metastable excitation levels (e.g. Ru (bipyridyl), see ref. 11).
- c) Investigations concerning the photo-assisted water decomposition with semiconductor/electrolyte cells.
- d) Study of the feasibility of a hybrid cell and eventual construction.

### 3.2.1.2 Bioconversion of Solar Energy

Since natural photosynthesis is the prime transformer of inorganic carbon ( $\text{CO}_2$ ) into highly usable organic form ( $100 \times 10^9$  tons/year) it is quite natural to investigate this process to see whether it would be possible to use it as a "device" to do this conversion artificially.

The first step in photosynthesis is of a physical nature. It is then normal to apply to this study methods and techniques borrowed from the Solid State Physics in which the JRC-Ispra has a good experience.

#### Technical Description

Among many important problems in the field of chemical and biochemical conversion of solar energy, two topics seem to be particularly suited for a more detailed theoretical investigation (to be carried out in close contact with different experimental groups within the European Community):

- a) The mechanism of energy transfer from the moment of photon absorption in a dye molecule (chlorophyll in natural systems, dye sensitizers, like rhodopsine, phthalocyanine etc., in artificial systems) to the moment of charge separation or chemical reaction.

The advance of experimental research in this field (based on recent pico-second laser and spectroscopic techniques) is producing a wealth of data in need of theoretical appraisal. JRC's experience in the field of solid state physics can be used for such theoretical research. Contacts are already established with experimental teams in this field and they will be strengthened with the CEA-group at Saclay.

- b) The mechanism of charge transport in membranes: natural and artificial membranes as well as other interfaces in double layer structures are effective means for charge separation in photochemical systems.

However, the details of charge transport by ionic and/or electronic motion across such boundaries present many unsolved theoretical and experimental problems. Theoretical research in this field could also be useful for the activity 3.2.1.1 on photoelectrochemistry.

3.3 PLANNING

TABLE E-I-04/f

SOLAR ENERGY				
PROJECT 3 : ORIENTATIVE STUDIES				
	1977	1978	1979	1980
<u>Electrochemical Solar Cells</u>				
- Electrode corrosion tests, protective coating, sensitization experiments				
- Investigation on photo-assisted water decomposition				
- Construction of Solar Cells				
<u>Bioconversion</u>				
- Theoretical Research				

3.4 MANPOWER AND COSTS

TABLE E-I-04/g

SOLAR ENERGY				
PROJECT 3 : ORIENTATIVE STUDIES				
	1977	1978	1979	1980
RESEARCH STAFF	4	4	4	4
INVESTMENTS (KUA)	← 60 →			
RUNNING COSTS (KUA)	50	50	40	40
CONTRACTS (KUA)	← 100 →			

### 3.5 CONNECTIONS WITH INDIRECT ACTIONS

Some of these activities are related to the Projects D and E of the Indirect Action Programme on Solar Energy. Coordination of the programmes of the Community is already ensured by a common ACPM for Direct and Indirect Action.

The ACPM on Solar Energy requested the group at the JRC, working with electro-chemical cells to contact scientists in Europe working in this field in order to promote an exchange of information. Experts in Bioconversion will be invited in the near future to the JRC in order to explore this field.

### 3.6 REFERENCES

- High Temperature Absorber Surfaces (see 1.2.6)
  - (1) J. J. CUOMO, J. F. ZIEGLER, J. M. WOODALL; App. Phys. Lett. Vol. 26, no. 10 (1975) 558
  - (2) J. DEJACE, R. MATERA, G. PIATTI; "Experimental Observations of Dendritic Duplex Crystals Growth in Complex Ni-Base Alloys", Journal of Mat. Science, 8 (1973) 754
  - (3) G. PIATTI, J. DEJACE, C. FOSSATI, R. MATERA; "The Growth Morphology of the Ni-Rich Ni-Ta-Cr-Mn System", Journal of Mat. Science, 9 (1974) 1917
  - (4) D. BOERMAN, R. MATERA, G. PELLEGRINI, G. PIATTI; "Morphology and Mechanical Behaviour of Aligned Dendritic Composites", Proceedings Second Int. Symp. on Composite Materials, Bratislava (Smolenice) - CSSR, Oct. 1975
- Electrochemical Solar Cells
  - (5) A. FUJISHIMA, K. HONDA; Bull. Chem. Soc., Japan, 44 1148 (1971); Nature, 228, 37 (1972)
  - (6) J. YAHIA; Phys. Rev., 130, 1711 (1963)
  - (7) H. GERISCHER; Electroanalytical Chem. and Interfacial Electrochem., 58, 263 (1975)
  - (8) W. GISSLER, to be published
  - (9) W. GISSLER, P. L. LENSI, S. PIZZANI; J. Appl. Electrochem., in press
  - (10) H. TSUBOMURA, Y. NAKATO, M. MATSUMURA, K. NAKOTANI, K. YAMAMOTO, T. OHNISHI; Proc. Int. Conf. on Solar Energy "ISEC 75", Los Angeles, 1975
  - (11) M. GLERIA, R. MEMMING, to be published.

## 5. HYDROGEN

PROGRAMME :  
HYDROGEN

TABLE OF CONTENTS

INTRODUCTION

1. PROJECT : THERMOCHEMICAL PROCESSES FOR WATER DECOMPOSITION

1.1. BACKGROUND

1.2. TECHNICAL DESCRIPTION

1.2.1. Phase A - Basic research concerning thermochemical decomposition of water

1.2.1.1. Paper studies

1.2.1.2. Experimental studies

1.2.2. Phase B - Bench-scale tests

1.3. CONNECTIONS WITH EXTERNAL ORGANIZATIONS

1.4. REFERENCES

1.5. MANPOWER AND COSTS

2. PROJECT : HEAT SOURCE COUPLING

2.1. BACKGROUND

2.2. TECHNICAL DESCRIPTION

2.2.1. Coupling Methods Assessment for Thermochemical Processes

2.2.2. Safety and Risk Analysis for Process Heat Applications

2.3. REFERENCES

2.4. MANPOWER AND COSTS

3. PLANNING

## APPENDIX E-I-05

PROGRAMME :  
HYDROGEN

INTRODUCTION

The role of Hydrogen in the future energy pattern of the European Community will be determined by a number of factors, such as the availability of fossil fuels and the needs for energy storage.

The general objective of the Hydrogen Programme is to evaluate the possibility to provide the European Community with alternate methods for production of Hydrogen from water considered as :

- a) chemical feedstock
- b) gaseous synthetic fuel
- c) energy vector for nuclear energy.

Even if applications cannot be foreseen for some time, a considerable research effort is required immediately in order

- ( i ) to have reliable elements for judging the potential role of hydrogen in the overall energy system
- (ii) to prepare the technologies necessary to make available practical alternatives when needed.

Hydrogen is considered :

- a) as a chemical feedstock : in view of a limited availability and an increase of cost of natural gas and hydrocarbons - which at present for the EEC are respectively the 60 % and the 31 % of the raw materials for hydrogen production - to provide alternate processes to the conventional methods of production.



- b) as a gaseous fuel (or a raw material for production of synthetic fuels, as for instance methanol) or mixed with natural gas : gaseous fuels have now, and will have in the future, a large part of the overall energy market. Electricity is now only 10-15 % of the end uses in the energy market; it will increase substantially and will cover in the future perhaps 40-50 % . The remaining part, however, is difficult to provide for and needs a fuel : a process for the production of synthetic fuels from non-hydrocarbon raw materials could be an interesting alternative in the long term, for the European Community.
- c) as an energy vector for nuclear energy : in this case, it should provide for nuclear power a possible application complementary to that oriented towards electricity production.

An identification of all prospective uses of hydrogen should be carried out as soon as possible. At the same time reliable information on possible industrial production methods and related production costs should be gathered. Using these elements, a review of possible uses together with an economic analysis will permit the derivation of cost thresholds in the future energy system.

In the medium term - a transition phase towards a system which is not essentially based on hydrocarbon raw materials, as it is now - the production of hydrogen from coal and steam will be the method used for industrial applications. However, in the long run, an alternative energy source will be required and hydrogen will be produced from nuclear energy - or maybe other forms of energy - by the decomposition of water, using electrolysis or thermochemical processes.

The potentialities of the thermochemical decomposition of water motivated several organizations and laboratories to initiate research programmes for the evaluation of this new possible method for hydrogen production.

The present situation of research in the EEC concerning hydrogen in the energy system and related problems, is the following :

- general assessments are made or are in progress, on a national basis, in the Netherlands, Germany, United Kingdom, Belgium, France;
- experimental research and theoretical evaluations are being carried out in the following laboratories :
  - University of Aachen and KFA, Jülich in Germany,
  - Gaz de France, CEA in France,
  - Joint Research Centre, Ispra (programme of "direct action", 1973-1976).

Several other organizations are making detailed techno-economic assessments of the different methods for hydrogen production from water, namely national centres and various industrial companies (e.g. chemical industries, oil companies, gas producers and/or users, nuclear industries, steelmaking companies).

More developed experimental testing of new, possible processes are being made at Ispra and in Aachen but this research is still in an exploratory phase for the selection of promising cycles.

- a programme of "indirect action" was decided by the Council of Ministers of the EEC, approving the proposal of the Commission concerning "Programmes of Research and Development Actions in the Field of Energy" (decision 22/8/75 - Official Journal 2/10/1975). Hydrogen is one of the items proposed. Three main projects are defined : production with thermochemical and hybrid cycles, production by electrolysis and uses. Total of partial financing is foreseen with a Community budget of 13.24 MUA for a 4-year period.

The first phase (July '75 - December '76) is in progress and a revision will be made before starting the second phase.

Other countries interested and actively working on Hydrogen are the United States and Japan.

In the United States several studies and research work are in progress, with private financing or as government programmes. Besides the great array of evaluations made on specific aspects of a hydrogen economy (transport, fuel for cars, airplanes and ships, catalytic burners, production, safety, etc.), a number of private companies are working on thermochemical production from water :

- Institute of Gas Technology, Chicago, financed by the American Gas Association, grouping gas producers,
- General Atomic, San Diego,
- Westinghouse, Pittsburg,
- Sandia, Albuquerque and Livermore.

Experimental tests are in progress in national laboratories; the most important activity is in Los Alamos and exploratory tests are being made in Argonne National Laboratory, Oak Ridge, etc. These laboratories work in collaboration with various Universities (Kentucky, Coral Gables, Ithaca, etc.).

In view of the preparation of a National Programme, a Hydrogen Energy Systems Technology (HEST) Study is in progress, with the support of NASA : the fiscal year 1975 was the first phase of a planned two-year programme definition effort, which could be the basis of a National Hydrogen Energy Systems, Technology Programme Plan, to start in the fiscal year 1977.

In Japan isolated activities performed over the last years are now included in the "Sunshine Project", a national technological development programme, planned from 1974 to the year 2000. To begin with, financing of the project is decided upon year by year, with total or partial contributions to the research expenses. Research on hydrogen is related to various aspects of production, transport, utilization; activities are performed in the National Chemical Laboratories of MITI (Ministry of International Trade and Industry) (Tokyo, Osaka), in the JAERI (Japan Atomic Energy Research Institute), and also in private industries such as Mitsubishi Heavy Industries and Hitachi.

It has to be mentioned that, in the framework of the International Energy Agency, the Sub-Group on Energy R&D recommended the implementation of a R&D programme on the production of Hydrogen from water. The Commission of EEC, through the Joint Research Centre, Ispra, was designated to act as the leading organization for the co-operative programme in the Hydrogen area. Technical meetings have already been held.

A list of main references concerning Hydrogen production by thermochemical decomposition of water, and some related problems, is reported in this document.

SUMMARY OF MANPOWER AND COSTS

PROGRAMME : HYDROGEN							
	Research Staff (per year)	Investments (M.U.A.)	Total Running Expenditures (M.U.A.)	Resources (M.U.A.)	Required Budget (M.U.A.)	Expected Income (M.U.A.)	
<u>PROJECT 1</u> THERMOCHEMICAL PROCESSES FOR WATER DECOMPOSITION	45	-	2.120	-	2.120	-	
<u>PROJECT 2</u> HEAT SOURCE COUPLING	5	-	0.280	-	0.280	-	
TOTAL	50	-	2.400	-	2.400	-	

The proposed resources concern exclusively Phase A.

If during phase A, a decision is taken to go to phase B, a revision of manpower and financial resources will be required.

The contracts are mainly foreseen in connection with chemical engineering problems, plant design and industrial data, specific experimental tests; they will ensure a good connection with industrial know how.

## 1. PROJECT : THERMOCHEMICAL PROCESSES FOR WATER DECOMPOSITION

### 1.1. BACKGROUND

The programme of work proposed for the JRC Pluriannual Programme is the identification, selection and testing of possible thermochemical cycles for water decomposition.

As heat sources, High Temperature Gas Cooled Reactors are mainly considered.

The objectives of this 77-80 programme are :

- To establish a comprehensive set of criteria, which may be used for comparing thermochemical cycles with each other and with electrolysis.
- To identify thermochemical cycles, which by meeting the comprehensive set of criteria are estimated to be economically competitive with electrolysis.
- To reach a decision point by the end of 1978 when the viability of a thermochemical route should be reviewed. The decision to go on to bench scale trials or to reduce the whole project to a much smaller size should be made at that point.

The proposed programme will have two phases :

phase A :basic research for the selection of thermochemical processes which may lead to a bench-scale experiment.

phase B :bench-scale test on one complete process.

The revision of the programme shall be done after two years; different alternatives will be considered :

- i) the construction of the bench-scale test,
- ii) the completion of the studies in progress,
- iii) a significant reduction of the effort and the studies.

The decision to start phase B will be taken at any moment, according to the technical progress.

If the results of the overall '77-80 programme will be positive, the activity could continue with the operation of the bench-scale test oriented towards the construction of a demonstration plant in the years '80s.

The general scheme of the Programme and the relationship between the phases A and B are shown in Table E-I-05/a.

## 1.2. TECHNICAL DESCRIPTION

### Description of the Activities

The activities foreseen in the two phases of the Programme are the following :

#### 1.2.1. PHASE A - Basic Research Concerning Thermochemical Decomposition of Water

The activity consists of continuous research and definition of possible cycles, using criteria for selection as for instance the number of process steps, the thermal efficiency of the cycle, space time yields, separation of products, safety and environmental constraints, corrosivity, transport of solid materials, transport of heat, availability and cost of process and construction materials, chemical losses, etc.

The activities are subdivided into two main parts :

- Paper Studies
- Experimental Studies.

##### 1.2.1.1. Paper Studies

###### a) Identification of New Cycles

The identification of new thermochemical cycles should be continued, based on literature, thermodynamics and chemical data.

###### b) Engineering and Cost Analysis of Selected Cycles

- Preliminary cost analysis of selected cycles.

The alternative methods for the preliminary estimation of the capital and operating costs of chemical processes will be reviewed, and discussed with industrial users. The more suitable methods will be routinely applied in a preliminary cost evaluation of alternative cycles.

- Flowsheeting of cycles.

The computer programmes already available at Ispra (OPTIMO and others) will be used as the first essential step in the detailed evaluation of cycles. Mass and heat balances will be prepared and thermal optimisation performed. In addition, transport losses will be assessed and a first visualization of the equipment required in the process steps will be made.

- Assessment using list of criteria.

The gradual development of an increasingly comprehensive list of criteria for the evaluation of cycles is a major objective of the programme. Some criteria have already been indicated and these will be expressed in quantitative form. Additional

quantitative criteria will come from the engineering design work described in the next section. The list of criteria will be continuously used in the evaluation of cycles and in their comparison with electrolytic hydrogen production.

- Engineering design of full-scale plant.

The eventual application of thermochemical cycles in the production of hydrogen will involve the operation of very large-scale chemical plants. Particular problems will be associated with the scale of operation and with coupling the plant to the nuclear heat source. It is foreseen that the identification of such problems will involve the following aspects of engineering assessment :

(i) Design of particular plant items

The chemical engineering design of particular plant items will be undertaken. Where kinetic data are lacking, assumptions will be made in order to specify the size (or range of size) of the equipment and its operating characteristics.

(ii) Capital cost estimates for particular plant items

Using the design specification obtained in the previous section, capital cost estimates will be made using, preferably, information from industry.

(iii) Engineering aspects of the high temperature chemical step

The particular engineering problems of coupling the endothermic high temperature chemical reaction step to the nuclear heat source, will be considered.

(iv) Conceptual plant design

A conceptual plant design will be made for a preferred thermochemical cycle. The design will produce a preliminary chemical engineering specification for all the main plants items, including heat exchangers. Capital cost estimates will also be made using information from industry.

c) Review of Industrial Process Data

It is advisable to seek data from unit operations existing in large scale chemical plants in order to apply these data to the evaluation of investment and operating costs of prospective thermochemical processes. The cost estimates should also account for material recovery and losses, as well as for energy losses. Further industrial problems such as availability of operation and down-time procedure as well as membrane transport shall be considered with respect to thermochemical and hybrid cycles.

Particular attention should be paid to the capital and operation cost of separation steps and to a comparison of the ideal thermodynamic separation efficiencies with those observed in plant practise.

d) Reactor Interfacing Problems

Special emphasis should be given to the problem of coupling the heat from a gas-cooled high temperature reactor. These questions comprise material problems in the heat exchange as well as the optimal adaptation to the energy vector. Studies are made considering mainly the chemical plant side.

Eventually solar energy may be taken into consideration for exploring possible application to specific processes.

1.2.1.2. Experimental Studies

a) Basic Research in Chemistry and Reaction Kinetics

The experimental tests foreseen after the selection of a cycle will permit a determination of the effect of the various parameters, such as temperature, pressure, stoichiometric ratio on the equilibrium composition and on the reactions kinetics. The same necessity holds for the electrochemical reactions that are part of a hybrid cycle, the aim being to find the operating conditions permitting the maximum current density with the minimum cell voltage.

Also measurements of physico-chemical properties including membrane separation could be necessary for refined thermal calculations.

After the collection of the more basic data, some kinetic test on continuous reactors may be foreseen if judged necessary.

The results of the engineering evaluation often call for operating conditions different from the optimum found in the chemical experiments. Reasons can be an improvement in matching with the thermal source, a better internal heat recuperation, or the necessity of alleviating a material problem. Consequently, modified chemical tests are needed to evaluate these alternative solutions. This support activity will be strongly interdependent with the engineering evaluation, and will determine the evolution of the performance of a cycle.

b) Material Studies

The selection and corrosion testing of materials for the cycle under study will be continued as a screening procedure. Materials will be differentiated according to their reasonable resistance to the main conditions of a promising cycle in static, semi-dynamic and dynamic tests. Commercial materials will be considered, both ceramic and metallic.

During the evolution of the Programme a materials evaluation will be made : on the basis of literature data, industrial experiences and experimental results, the evaluation of potentially useful materials will be pursued in close connection with the flow sheet studies.

The skills and techniques for the majority of the post-corrosion evaluations (optical, electronic, electro-scanning microscopy) exist already and may be used if necessary.

### 1.2.2. PHASE B - Bench-scale Tests

As mentioned earlier the decision to embark on phase B will be dependent on technical progress. If phase B is undertaken, it will involve the design and construction of bench-scale plant. The experiment will be principally directed to the continuous operation of all the reactions of the selected cycle in an integrated closed system (production of 1-10 m<sup>3</sup> H<sub>2</sub>/h). Concurrently, all problems relating to the continuous separation and circulation of the reaction products will have to be resolved, in order to provide design and construction data for demonstration plants. In this respect these experiments will also serve as screening tests for various construction materials (refractory or metallic) under more realistic operating conditions, and, hence, aid in later engineering designs. Similarly, specific instrumentation and control circuit elaboration and/or development will have to be part of this activity. Further, at this stage experimental results will be used in more realistic engineering calculations. Two or more different types of reactors may be tested in parallel, for one and the same reaction, be it for convenience of structural design, better reaction yields or ease of reactant flow from or to the neighbouring reactor.

### 1.3. CONNECTIONS WITH EXTERNAL ORGANIZATIONS

The activities of the JRC have to be seen in a wider scheme so as to make the maximum use of its results and to increase the efficiency of the overall effort.

The connections of the JRC programme already existing with external organizations are the following :

- An agreement for co-operation operating since 1973 between the Commission of the EEC (DG XII and JRC), the Kernforschungsanlage Jülich, the Rheinische-Westfälische Technische Hochschule, Aachen; during 1975 the "Commissariat pour l'Energie Atomique - Centre l'Etudes Nucléaires - Saclay", joined the agreement.

The co-operation consists of a mutual exchange of information and the co-ordination of some common activities; technical meetings are periodically held.

- The indirect action programme in the field of Hydrogen, adopted in 1975 by the Council of Ministers, allows the overall research effort within the Community to be expanded and made more comprehensive.



The coherence of the JRC Programme and of the indirect action programme will be ensured by the role of Ispra as Head of the Project for the thermochemical production of Hydrogen and by the extension of the competences of the ACPM-Hydrogen to the direct and indirect actions on hydrogen.

- The cooperative programme on R & D on Hydrogen production from water, decided in the framework of the International Energy Agency, should be considered as an additional way for implementing exchanges and connections. The Commission of European Communities acts as project leader for this programme and the JRC is entrusted with the scientific secretariat of the Co-ordinating Committee on Thermochemical Processes.

#### 1.4 REFERENCES

- H. CREMER, J. SCHUBERT, G. STEINBORN, T. RITTERBEX, K.F. KNOCHE, RWTH Aachen; "Water Splitting Processes of the Iron-Chlorine Family", Proceedings B.N.E.S. The High Temperature Reactors and Process Applications, 26-28 November 1974, London.
- K.F. KNOCHE, H. CREMER, G. STEINBORN, RWTH Aachen; "Thermochemical Processes for the Production of Hydrogen". Proceedings University of Miami, Hydrogen Energy Fundamentals, 3-5 March 1975.
- K.F. KNOCHE, H. CREMER, RWTH Aachen; "Thermodynamics of Thermochemical Water Splitting Cycles", Proceedings JRC-Ispra. The Hydrogen Energy Concept, September 29 - October 3, 1975.
- H. BARNERT, K.F.A. Jülich; "Hydrogen from Nuclear Energy : Concepts and Economy". Proceedings European Nuclear Society : The European Nuclear Conference, April 21-25th, 1975, Paris.
- H. BARNERT, K.F.A. Jülich; "The HTR Nuclear Heat Service and Its Coupling to a Chemical Plant", Proceedings of JRC - Ispra, 1974.
- R. SCHULTEN, C.B. VON DER DECKEN, H. BARNERT; "Nuclear Water Splitting by Heat from the Pebble Bed HTR", Proceedings B.N.E.S., London, 1974.
- J. POTTIER, D. SOURIAU, Gaz de France : "Chemical Cycles Studied by Gaz de France for Production of Nuclear Hydrogen as a Future Energy Vector", Proceedings B.N.E.S., London, 1975.
- B. ESTEVE, A. LECOANET, J.P. RONCATO, Gaz de France; "Thermodynamique des Cycles Thermochimiques de Décomposition de l'Eau", Entropie N° 61 - 1975.
- J.B. PANGBORN, J.C. SHARER, Institute of Gas Technology, Chicago; "Analysis of Thermochemical Water Splitting Cycles", Proceedings THEME Conference, University of Miami, March 18-20th, 1974.
- J.B. PANGBORN, D.P. GREGORY, Institute of Gas Technology; "Evaluation of Thermochemical Hydrogen and Oxygen Production from Water", Proceedings B.N.E.S., London, 1975.
- D.P. GREGORY et al.; "A Hydrogen Energy System", American Gas Association, Cat. N° L. 31173, August 1972.
- J.L. RUSSEL, J.T. PORTER, General Atomic; "A Search for Thermochemical Water Splitting Cycles", Proceeding THEME Conference, University of Miami, March 18-20, 1974.

- B.M. ABRAHAM, F. SCHREINER, A.N.L.; "General Principles Underlying Chemical Cycles which Decompose Water into the Elements", I. & E.C. Fundamentals, Vol. 13, N° 4, p. 305-310, 1974.
- C.E. BAMBERGER, D.M. RICHARDSON, M.A. BREDIG, ORNL; "Thermochemical Decomposition of Water Based on Reactions of Chromium and Barium Components", Science, Vol. 189, p. 715-716, August 29th, 1975.
- M.G. BOWMAN, Los Alamos; "Fundamental Aspects of Systems for the Thermochemical Production of Hydrogen from Water", Proceedings of the First National Topical Meeting on Nuclear Heat Application, Los Alamos, October 1-3, 1974.
- J.E. FUNK, N.L. CONGER, R.H. CARTY, R.E. BARKER, University of Kentucky; "Thermochemical Production of Hydrogen from Water", Proceedings B.N.E.S., London, 1974.
- J.E. FUNK, University of Kentucky; "Thermochemical Production of Hydrogen Via Multistage Water Splitting Processes", Proceedings of the University of Miami, Hydrogen Energy Fundamentals, 3-5 March, 1975.
- J. LINKE et al.; "Cornell University Ithaca : Proceedings of the Cornell International Symposium and Workshop on the Hydrogen Economy", Ithaca, 1973.
- S. KATO, Agency for Industrial Science and Technology - MITI; "Tasks for Clean Energy and Sunshine Projects", CEER, Jan.-Febr. 1975, vol. 7, N° 1, 2, p. 15-31.
- Y. KOTERA, N.C.L., Tokyo; "Thermochemical Study in National Chemical Laboratory for Industry", Proceedings U.S.-Japan Joint Seminar on Key Technologies for Hydrogen Energy System, July 1975, Tokyo.
- S. KATO, Y. IKEZOE, M. TAKEHISA, R. UEDA, J.A.E.R.I., Tokai Mura; "Closed Cycles Hydrogen Production via CO<sub>2</sub> Decomposition", U.S. - Japan Joint Seminar - July 1975, Tokyo.
- J.H. SWISHER, SANDIA Corporation; "Hydrogen Compatibility of Structural Materials for Energy Storage and Transmission Applications", Report SANS 75-8040 - 1975.

#### TECHNICAL REPORTS OF THE J.R.C.

- The progress of the study in the framework of the Hydrogen Programme at Ispra is described in the following annual reports :
  - Hydrogen Production from Water Using Nuclear Heat :
  - Progress Report N° 1 (1970) - EUR 4776 e
  - " " N° 2 (1971) - EUR 4955 e
  - " " N° 3 (1972) - EUR 5059 e
  - " " N° 4 (1973) - Communication COM 3194
  - " " N° 5 (1974) - " COM 3234
- Some papers presented at Scientific Conferences :
- G. DE BENI, C. MARCHETTI; "Mark-1, a Chemical Process to Decompose Water Using Nuclear Heat". Symposium on Non-Fossil Chemical Fuels, Am. Chem. Soc., Meeting, Boston, April 9-14, 1972.
- G. DE BENI; "Considerations on Iron-Chlorine-Oxygen Reactions in Relation to Thermochemical Water Splitting", Theme Conference, Miami, March 18-20, 1974.

- G. BEGHI, J. DEJACE, C. MASSARO, B. CIBORRA; "Economics of Pipeline Transport for Hydrogen and Oxygen", Theme Conference, Miami, March 18-20, 1974.
- G. BEGHI, A. BROGGI, G. DE BENI; "Thermochemical Water Splitting as a Method for Hydrogen Production". B.N.E.S. Conference : the High Temperature Reactor and Process Applications, London, November 26-28, 1974.
- G. DE BENI; "Hydrogen Production by Water Splitting : Closed Cycles of Chemical Reactions", European Nuclear Conference, April 21-25, 1975.
- A. BROGGI, G. BEGHI; "Method of Evaluation of Nuclear Thermochemical Processes for Water Decomposition". European Nuclear Conference, April 21-25, 1975.

### 1.5. MANPOWER AND COSTS

PROGRAMME : HYDROGEN				
PROJECT 1 : THERMOCHEMICAL PROCESSES FOR WATER DECOMPOSITION				
	1977	1978	1979	1980
RESEARCH STAFF	45	45	45	45
INVESTMENTS (K.U.A.)	-	-	-	-
RUNNING COSTS (K.U.A.)	230	230	230	230
CONTRACTS (K.U.A.)	300	300	300	300

## 2. PROJECT : HEAT SOURCE COUPLING

### 2.1. BACKGROUND

The analysis of the heat source associated with the process operation will undoubtedly play a very important role in the overall hydrogen programme : the future perspectives of hydrogen production by chemical water splitting have to be checked against the feasibility of association of the chemical process with a reliable economic and safe heat source. Only by a parallel study of these two programmes can a clear definition of the overall hydrogen production scheme be ascertained and the right requirements for new developments in technology and in the materials field can be defined.

Indeed, different engineering solutions, safety and operational requirements and the optimization of energy flow sheets may alter very much the specifications of the hydrogen production process itself.

As previously outlined, the optimal choice of the associated heat source with the process operation is influenced by many factors : the process characteristics will indicate the temperature range of interest for the primary coolant, safety considerations together with the need of high plant availability will have to be accounted for in the choice of the coupling solution, development of metals or of ceramic materials for very high temperature will bound the engineering design, and the core performances finally will have to ensure a safe and reliable operation of the plants.

The objective of the study is the analysis of the problems concerning the association of the heat source to the thermochemical production of hydrogen, taking into account the noticeable experience that throughout the world has been recently acquired on other processes such as natural gas reforming and coal and lignite gasification. Most of the work will be centered on the use of HTR's, but attention will also be given to the use of solar energy as a heat source.

Several national and international organizations have, in the last few years, dedicated a considerable effort to the study of coupling the HTGR to various industrial processes. First examples of these activities can be found in Germany, in the DRAGON project and in the J.R.C. (Ispra). Since 1971 the interest in the process heat application of HTGR is ever increasing and various coupling design solutions have been proposed : the process operations on which most attention has been focused, up until now, are steam reforming by methane in connection with large steel making plants and with coal hydro-gasification and lignite gasification.

The most active partners in these studies have been the German firms and research centres (HRB, Rheinische Braunkohlenwerke, AG, RWTH Aachen, Bergbau-Forschung GmbH, STAEG AG, KFA, Jülich, Interatom), the DRAGON project, the European Nuclear Steelmaking Association (E.N.S.E.C.), General Atomic, the Japanese experimental project Multi-Purpose HTGR.

## 2.2. TECHNICAL DESCRIPTION

The proposed study of association of the heat source with the chemical processes will be divided into the two following main parts :

### 2.2.1. Coupling Methods Assessment for Thermochemical Processes

This study will evaluate the optimal solutions for the coupling from the point of view of thermal balance, overall layout and safety; in the heat exchange, emphasis will be given to the chemical process side.

The specific task will cover the optimization of the thermal flow sheet of the coupling, taking into account the reactor requirements in terms of inlet and outlet gas temperature, mass flow, auxiliary core cooling system, temperature drop in the various heat transfer stages, etc. and also by considering heat recovery from various process stages, electricity production, if any, for use in situ or for selling to the grid, and the kinetics of the process operation.

Alternative schemes have to be worked out for association solutions calling for an intermediate heat exchanger : the safety implications of the various choices have to be evaluated.

The problem of integration or complete separation of the process plant and the reactor will have to be tackled together with the consequences for the optimum flowsheet. If an intermediate heat exchanger is chosen, the nature of the secondary heat carrier fluid will have to be investigated : solutions can range from He to N<sub>2</sub>, CO<sub>2</sub>, H<sub>2</sub>O to liquid metals (Pb, Na condensation-evaporation process, etc.). For each solution an assessment in terms of thermal efficiency (taking therefore into account pumping power, etc.), operational and safety problems will have to be carried out.

The prevailing problems for a suitably designed heat exchanger are : the thermal stresses, the reliability, the possibility of performing repairs, the performance of repeated tests and in particular the materials to be used.

Several heat exchanger geometries will have to be studied : one-through arrangement, adiabatic multi-stage reformers, coaxial tube heat exchangers, etc.

The possible use of ceramic materials for the heat exchanger will also have to be assessed, together with the relative problems of poor ductility and leak-tightness and difficulty of joint design.

### 2.2.2. Safety and Risk Analysis for Process Heat Applications

The normal characteristics of the association of a nuclear reactor with a process plant reflect in some new safety aspects that have to be taken into account in the design layout. Three main requirements call for a fresh look into some aspects of the HTGR safety; they are: increased gas outlet temperature, risk from the adjacent industrial plant, improved system reliability.

Already in the description of the previous actions of this programme, references have been made to general safety assessment studies that have to be performed in order to bound the decision process for the optimum association scheme. Indeed, the performance of this analysis will be the major duty of the group activity, in particular an appreciation will be needed for the different prospected coupling solutions, of the emergency/auxiliary core cooling capacity. In this respect a number of schemes have been envisaged for the steam cycle.

Each of these schemes or even new solutions have to be assessed taking into account the different alternatives of the coupling schemes : with or without electricity generation, direct or indirect heat transfer, nature of the intermediate secondary heat vector fluid etc.

Another item of particular importance for its feedback on the reliability, maintainability and accessibility of the primary circuit is the assessment of the fission product release and its plate-out on the metallic surfaces.

Another important safety aspect is the one related to chemical reaction of secondary coolant with the core graphite whose temperature is higher than in a steam cycle HTR. In a process HTR it is possible to conceive of a number of fluids which could leak from the secondary to the primary circuit depending both on the process and on the detailed plant design. An assessment will have to be performed for all such possibilities and a study made of the potential chemical reactions, of their regime and the reaction products to see if any additional hazards arise. Due care, for instance, has to be spent on the study of  $H_2$  permeation from the process towards the reactor core through heat exchanger materials at high temperature.

All these leakages, if substantial, may be of particular importance if they occur just before, at, or just subsequent to a depressurization when the possibility arises of air mixing with the reaction products to form an explosive mixture. Another additional risk of explosion may arise from the reaction of the process fluid with air if, for instance, in the case of a direct coupling, the secondary circuit fails discharging in the containment atmosphere : there should be some arguments for inerting (i.e. blanketing with nitrogen) cavities within the vessel containing process plants.

The possibility that detonations originating in nearby process plants could damage the reactor plant, has also to be accounted for in the framework of the plant acceptability problem. It has to be noticed in this respect that not all is known at present on the mechanism of explosion in large inflammable mixtures. These studies will be the object of a theoretical analysis.

2.3 REFERENCES

- W. WENZEL; Tech. Mod., November, 61, 431-435 (1969).
- A. ANTONELLI, J.I.S.I., 207, 1038 (1969).
- S.B. HOSEGOOD, R.F. MC IVER, G. MANCINI; "The High Temperature Gas Cooled Reactor - A Process Heat/Electrical Energy Source for a Large Steelworks", DPR 751 (1971).
- H. BARNERT, K. KUGELER, M. KUGELER; "Problems on the Safety of Future Process-Heat Reactors". IAEA/SM-169/41.
- C.S.B. HOSEGOOD, H. GUTMANN, G. MANCINI et al.; "Preliminary Outline for a 1000°C Prismatic-Fuelled HTR to Supply Process Heat and Electricity", Dragon Project Technical Note, 1973.
- N. HAWKES, S.B. HOSEGOOD, "The HTR : a Process Heat/Electricity Energy Source for a Large Steelworks", B.N.E.S. Journal Vol. 10, N° 4, October 1971.
- Humphreys and Glasgow Ltd.; "Potential Industrial Applications of High Grade Process Heat from a HTGR", DP 895, 1974.
- QUADE; "The HTGR as a Source of High Temperature Process Heat", G.G.A. Report A12453 (PH 215), January 1973.
- Hochtemperatur-Reaktorbau GmbH Konzept der HRB für die frühzeitige Markt-Einführung nuklearer Prozesswärme, Köln, 1974.
- G. MANCINI, R. DEL BECCARO, P. ASHWORTH; "Safety Aspects of HTR's", B.N.E.S. Conference, October 1973.
- "The HTR and Process Applications", B.N.E.S. Conference, 26-28 November 1974.
- XIII Giornate dell'Energia Nucleare, 1974. FAST-Milano. December 1974.
- Specialist Meeting on HTGR Safety; "Current Status and Perspective", Petten, 13-15 May, 1975.
- H.M. KOTTOWSKY, M. MOL, C. SAVATTERI; "Application of Boiling Liquid Metals in Industrial Processes". EUR/C-IS/541.

2.4. MANPOWER AND COSTS

PROGRAMME : HYDROGEN				
PROJECT 2 : HEAT SOURCE COUPLING				
	1977	1978	1979	1980
RESEARCH STAFF	5	5	5	5
INVESTMENTS (K.U.A.)	-	-	-	-
RUNNING COSTS (K.U.A.)	20	20	20	20
CONTRACTS (K.U.A.)	50	50	50	50

3. PLANNING

The different activities foreseen in the Programme are mainly subdivided into two phases, A and B; the sequence of the activities is linked to the technical results obtained during the work.

The scheme of activities and decisions regarding the study of a thermo-chemical process has already been shown in table E-I-05/a. The planning is shown in table E-I-05/b



TABLE E-I-05/a

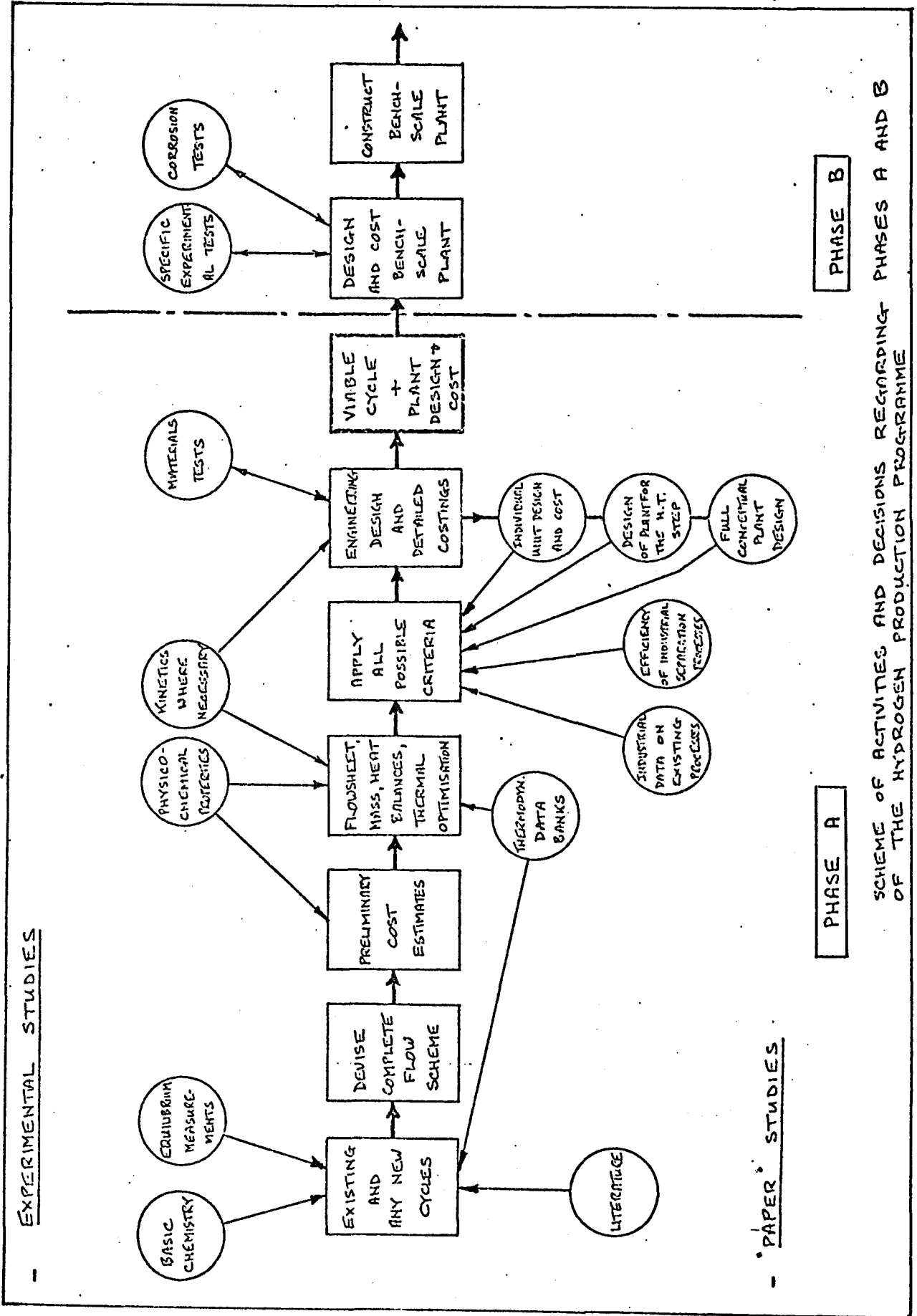
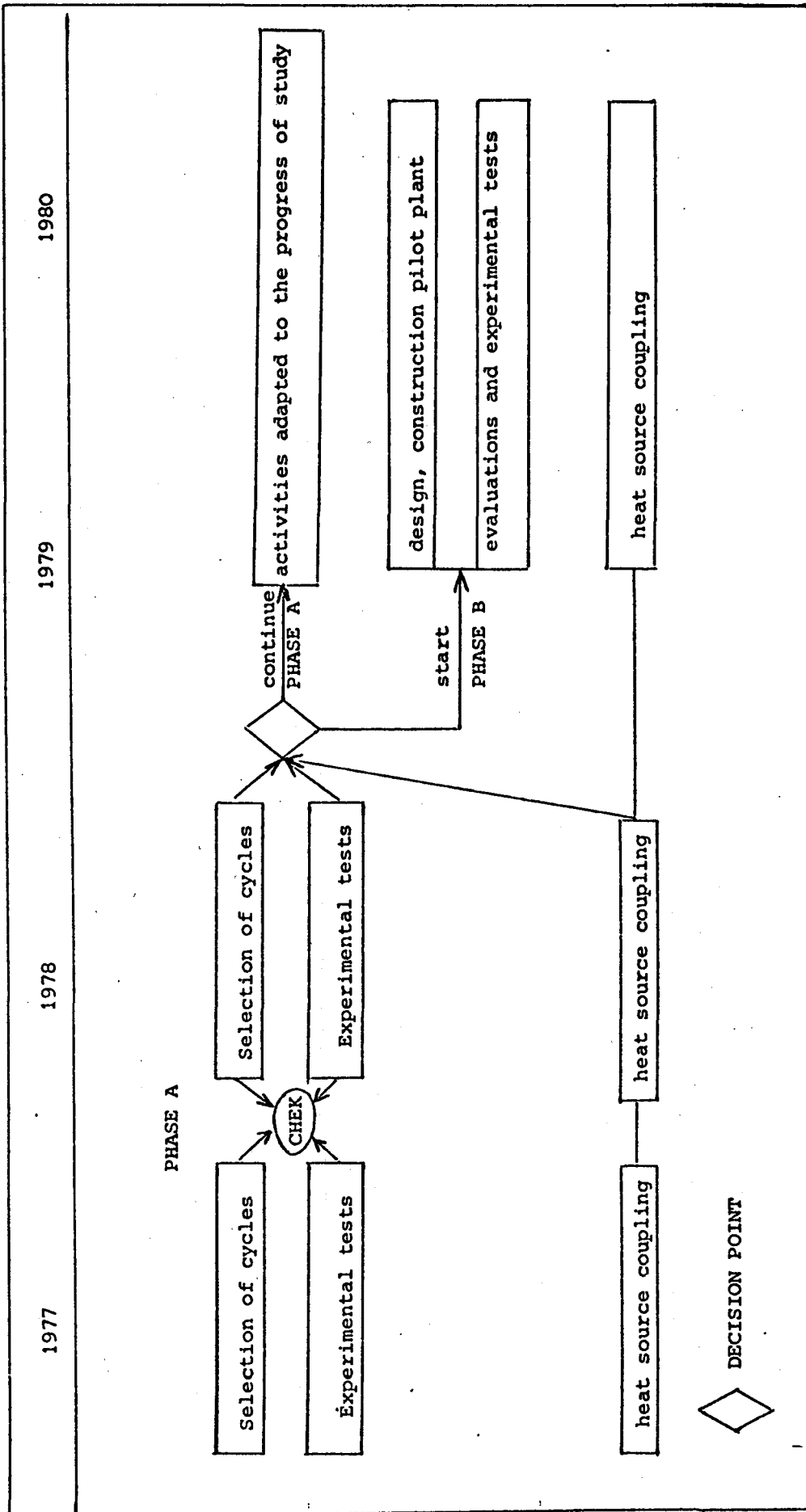

TABLE E-I-05/b - PLANNING



ADVISORY COMMITTEE  
ON PROGRAMME MANAGEMENT

-----  
"HYDROGEN"

DRAFT OF AN "OPINION" \*)

The Committee has examined the proposal for the "Hydrogen Programme 1977 - 1980 (document EUR/C/IS/868/75e) and, on request of the General Advisory Committee, has prepared the following opinion, during the meeting of February 2 and 3, 1976.

- The Committee was impressed by the work of the Expert Group (report EUR/C/IS/887/75) which had contributed substantially to the formulation of the Commission/s proposal.

The Committee has a favourable attitude towards the proposed programme on hydrogen production presented by the Commission, but does not support, in accordance with the recommendation given in the Expert's Report, the basic research programme on hydrides.

Hydrogen Production

- The Committee agrees to the continuation of the studies in progress described in the proposal of the Commission which correspond to the know how and competences developed.
- The Committee considers that the manpower effort as amended in the corrigendum issued on January 23rd to report 868/75 to be acceptable and corresponding to the importance of the research and of the problems to be solved during the activities foreseen by the programme.
- The Committee emphasizes that a major part of the activities requires a chemical engineering competence that the JRC should make available for the programme.
- The Committee underlines that the personnel foreseen for the installation of a bench scale unit (phase B), evaluated as 20 research man, will be reviewed when the decision is taken. The Committee foresees that the personnel for this unit should come, as much as possible, from those who are already involved in phase A according to the competences available.
- The Committee expressed the wish to be engaged in the decision to start phase B, during the development of the programme.

-----  
\*) accepted by the Chairman, final approval under way.

## 6. CONCEPTUAL STUDIES ON THERMONUCLEAR FUSION REACTORS

PROGRAMME \*  
CONCEPTUAL STUDIES OF THERMONUCLEAR FUSION  
REACTORS

TABLE OF CONTENTS

INTRODUCTION

1. BACKGROUND

2. TECHNICAL DESCRIPTION

2.1 BLANKET NUCLEONICS

2.2 HEAT TRANSFER AND ENERGY CONVERSION SYSTEM

2.3 MATERIALS

2.4 STRESS ANALYSIS

2.5 SAFETY AND ENVIRONMENTAL IMPACT

2.6 PLANT ENGINEERING

2.7 COST ANALYSIS AND POWER REQUIREMENTS

3. PLANNING

4. MANPOWER AND COSTS

5. CONNECTIONS WITH INDIRECT ACTIONS

6. REFERENCES

\*) Programme still to be submitted to the opinion of the Fusion Consultative Committee.

## APPENDIX E-I-06

PROGRAMME CONCEPTUAL STUDIES OF THERMONUCLEAR FUSION REACTORS
---

INTRODUCTION

During the past several years there have been notable developments in research on controlled fusion reactor systems (1-4). Up to the present time, among the many configurations proposed to contain a plasma, the Tokamak is the most important, as far as available results indicate, and this programme is correspondingly the most important.

Results obtained in devices such as ST, ATC, ORMAK and DOUBLET-II (USA), T-4 (USSR), TFR (France) have been encouraging.

It is generally considered that a large increase in the present results can be obtained simply by increasing the size of the machines. The next generation of experiments typified by the T-10 in the USSR, by PLT (1975) and DOUBLET-III (1975) in the USA, could obtain plasma conditions on the threshold of the reactor regime within the next year or so. Detailed design has commenced on TFTR (Tokamak Fusion Test Reactor (5)) which is intended to achieve a reactor regime plasma and to obtain plasma energy break-even with D-T burn by the early 1980's.

The Euratom JET (6) Projet (1979-1982) is similar to TFTR and should yield decisive results on the practical feasibility and exploitation of a Tokamak reactor.

An alternative approach to controlled fusion power is inertial confinement which is based on the concept of target compression by means of powerful lasers or electron beams (7). Significant technological advances are required to make these systems technically and economically viable.

As confidence in the potential of, at least some of the proposed reactor models, grows, more attention is being paid to technological problems. An important first step are the conceptual design studies of which several have already been performed. These studies help to identify outstanding physical and technical questions as well as to verify the compatibility of solutions proposed for the different parts of the overall system.

The general objective of system studies (8) is to combine the present knowledge of plasma physics and nuclear technology in order to obtain an overall view of a fusion power system. More specifically, these studies can be of value in evaluating alternative confinement geometries as potential reactor systems, as an aid to planning the most effective plasma physics research programme, in evaluating the technological and engineering problems involved in fusion development as an aid to establishing a balanced reactor technology programme and in the analysis of the operational economic and environmental advantage of fusion as a basis for a possible justification of the growing fusion research and development programme.

The majority of studies undertaken so far, are based on the Tokamak confinement system, since it is currently favoured as the system in which feasibility will first be demonstrated.

Four conceptual Tokamak Reactor Designs have been performed in detail: one at the Oak Ridge National Laboratory (9), the UWMAK conceptual reactor of the University of Wisconsin (10), the design of the Princeton Plasma Physics Laboratory (11), and the conceptual design of JAERI (12). These designs have been focused on devices which would be suitable for commercial applications and which are several stages remote from the TFTR.

Furthermore, there have been other conceptual design studies performed in the USA on other concepts: the Los Alamos-Argonne Reference Theta-Pinch Reactor (RTPR) (13), the Lawrence Livermore Laboratory conceptual magnetic mirror reactor (14) and the LASL conceptual laser driven fusion reactor (15).

In Europe the first conceptual reactor design was undertaken at Culham Laboratory (16). The basis for the design was a 5830 MW Tokamak device. Of the engineering problems considered, particular attention was given to the question of maintenance and the replacement of damaged parts, and also to the implications of alternative coolant fluids.

A second reactor design based on Tokamak geometry (17) was undertaken as a collaborative effort by CNEN (Frascati), JRC-Ispra and the University of Naples. In this case the objective was to study an experimental reactor which would precede the construction of a full-scale prototype.

A reactor based on the inertial confinement of laser heated D-T pellets (18) has been studied at KFA (Jülich).

During the last year there has been a growing interest in the USA in the next step beyond the TFTR to an experiment which will provide the

necessary interface between scientific feasibility experiments and the first demonstration power plants.

Although the objectives of this class of Tokamak experimental power reactors are not clearly defined yet, several groups have begun studies.

One class of facilities referred to as FERF (Fusion Engineering Research Facility) is intended for performing radiation damage and material studies, and is characterized by a high 14 MeV neutron wall loading.

On the FERF concept, work has been done at the Lawrence Livermore Laboratory, based on the Mirror Concept (19), while Abdou et al. (20) have proposed an FERF based on a Toroidal Theta-Pinch.

More recently, R. W. Conn and D. L. Jassby (21) have proposed a Tokamak Engineering Test Reactor (TETR), which is a beam driven Tokamak, operating in the two-energy component (TCT) mode combined with some recent innovations in blanket and toroidal field magnet design to produce a relatively small and flexible reactor. The TETR should have the function of testing blanket and shield designs, performing radiation damage and material studies and testing solutions to other major engineering problems such as tritium handling and leakage control and remote handling techniques.

In the Wisconsin TETR the plasma temperature is maintained by the injection of 200 keV neutral deuterium beams, the plasma dimensions are  $a = 0.55$  m and  $R = 3.05$  m, and the evaluated cost is  $385 \cdot 10^6$  dollars.

Other conceptual design studies are being carried out to develop the engineering characteristics and the principal features of a Tokamak fusion experimental power reactor (TEPR), the primary objectives of which are to demonstrate the production of electric power from fusion, employ the basic components of a prototype plant reactor and achieve plasma conditions appropriate for a power producing reactor.

The Argonne National Laboratory has proposed a 150 MW Tokamak Experimental Reactor (22) with a non-circular plasma cross section and has indicated that a TEPR with a major radius  $R = 4-5$  m is feasible if one takes advantage of the inherent size reduction associated with non-circular plasma cross sections.

In the framework of the EPR, work is being carried out at ORNL (23) and at General Atomics (24). The parameters of the USSR T-20 Tokamak are still under discussion and the design has not yet started.



SUMMARY OF MANPOWER AND COSTS

PROGRAMME: CONCEPTUAL STUDIES OF THERMONUCLEAR FUSION REACTORS						
Research Staff (per year)	Investments (MUA)	Total Running Expendi- tures (MUA)	Resources (MUA)	Required Budget (MUA)	Expected Income (MUA)	
8	---	0.28	---	0.28	---	---

## 1. BACKGROUND

A first analysis of the "know-how" existing at the JRC-Ispra which can be exploited for fusion reactor applications, started at Ispra in 1971. From this study it appeared that a consistent contribution could be given mainly in the area of fusion reactor assessment and technology.

The JRC has at its disposal a number of calculation methods and design "know-how" for such studies. In particular:

- nuclear data libraries and methods for the calculation of breeding ratio, neutron and gamma energy deposition in blanket and shielding, radiation damage effects (as displaced atoms and helium and hydrogen production rates).  
A modular code system to deal with these different parts of the nuclear calculation in a one- and two-dimension approximation is already in operation;
- thermohydraulic and stress analysis codes to deal with up to three-dimensional geometry problems. These codes, based on the "Finite Elements" method, are suitable both for thermal and electromagnetic stress and strain evaluations;
- codes and nuclear data for the evaluation of activation and afterheat evolution;
- general layout of the reactor components, operation, maintenance and handling of activated materials;
- reliability and safety assessment;
- tritium recovery;
- computer codes and facilities for investigation of the behaviour of materials and structures under dynamic conditions;
- in the framework of the 1973-1976 "Material Science Programme" basic research work is in progress at the JRC-Ispra, on surface physics (sputtering and gas trapping, blistering and gas re-emission, desorption), radiation damage (self-diffusion and radiation-influenced diffusion in metals, point defects of b. c. c. materials, high temperature neutron and ion irradiation of vanadium) and compatibility of metals and alloys with lithium.

In April 1973 a programme proposal was submitted for advice to the Liaison Group of Fusion Associations of the EEC. On the basis of the Liaison Group's recommendation, an activity on conceptual design studies in support to Associated Laboratories was started. The development

of this activity has been included in the JRC 1975-programme.

In this framework a collaboration has been agreed with the Euratom-CNEN (Frascati) Association for the conceptual design *studies* of an experimental power fusion reactor (FINTOR), intended to precede the construction of a full prototype reactor of the Tokamak-type.

As a first approach, work has been done in the direction of determining the minimum dimensions compatible with the energy plasma balance criteria and engineering limits using well known materials and reactor technology, without the goal of achieving the wall loading required for bulk radiation damage studies.

## 2. TECHNICAL DESCRIPTION

The development of the conceptual design of a Tokamak Experimental Power Reactor in collaboration with CNEN (Frascati) and other national laboratories, members of the Fusion Associations of the EEC, will be the central task of the JRC-Ispra activity.

The objective of the FINTOR (Frascati-Ispra-Naples Torus) Project was the identification of the main physics and engineering limits to the minimum size of an Experimental Tokamak Reactor, whose construction would precede a full-scale prototype reactor, yet which would include all the essential technology. The subdivision of the tasks inside the FINTOR group, are schematized in Fig. 1. The size of the reactor was determined by solving, in a self-consistent manner, the steady state power balance equations for the plasma. By specifying additional technological limits for the blanket thickness, the size of the transformer core, and the maximum magnetic field in the superconducting coils, a minimum reactor power of 87 MW<sup>th</sup> was obtained. The physical dimensions of the reactor are similar to those proposed for full-size power reactors, major toroidal radius 9 m, minor first wall radius 2.55 m, with the result that the average power loading and neutron flux at the first wall are an order of magnitude lower than in a power reactor. The results of this study will be summarized in the "FINTOR-1" final report, to be published in 1976.

The future activity of the JRC Centre will deal with the assessment of the main physics and engineering limits connected with different levels of capability of a Tokamak-type experimental reactor. The capability levels considered will be:

- demonstration of the ability to ignite and control a D-T plasma (D-T burner),
- production of a small amount of net electrical power,

- engineering test (high wall loading).

In order to improve the plasma performance, it will be necessary to take advantage of the inherent size reduction associated with non-circular cross section plasma's.

Non-circular cross sections require a two-null point divertor and as a consequence open up the possibility of reducing the aspect ratio. The implications of an air-core transformer or of a saturated iron core transformer, will be investigated in detail.

Solutions involving normal (D-T burner) and superconducting toroidal field coils, will be assessed and compared.

## 2.1 BLANKET NUCLEONICS

The specific task of this group will cover:

- the optimization of the blanket design taking into account tritium production, heat deposition, energy multiplication, surface and bulk damage, tritium inventory and recovery. The possibility of using solid blanket materials in the form of microspheres, to reduce the tritium inventory and the hazards connected with liquid lithium, will be analyzed;
- different concepts of low-Z material curtains to be interposed between the first wall and the plasma, in order to reduce the bremsstrahlung losses will be analyzed;
- the optimization of the shield design in order to achieve both minimum damage and minimum heat deposition in the superconducting coils will be pursued by comparing different heterogeneous configurations of different composition;
- this group will improve the calculation models now in use for the neutron and gamma flux calculation in one-, two- and three dimensions, and will update the nuclear data libraries. For this last task reference will be made to the ENDF-B IV (25) point data library.

The AMPX code (26) will be used for the preparation of a gamma production library, the MACK (27) code for the calculation of neutron kerma factors, taking into account  $\beta^-$  and  $\beta^+$  decay from activated residual nuclei.

The code DON (28) for the calculation of displaced cross sections should be acquired by the group.

Theoretical analysis of surface and bulk radiation damage on the basis of displacement and transmutation calculations, and of macroscopic data from fast reactor material test experiments and simulation experiments, should be pursued in close collaboration with the Materials Group.

## 2.2 HEAT TRANSFER AND ENERGY CONVERSION SYSTEM

This group will use heat deposition distribution data coming from the Blanket Engineering group for the optimization of the blanket cooling system in terms of inlet and outlet gas temperature, number of heat exchange units, mass flow and temperature drop in the various heat exchangers.

The possibilities of extraction, storage, conversion or utilization of the fusion energy produced will be analyzed from the point of view of testing and demonstration.

The cooling of the spectral shifters and of the divertor plates will be a task of this group.

## 2.3 MATERIALS

A Materials group is envisaged. This group should be in charge of the materials choice from the point of view of compatibility, radiation damage, tritium permeation.

In particular the group should provide information on the characteristics of solid blanket materials in the form of microspheres, microsphere dimension for tritium diffusion, sintering of microspheres at high temperature, solid breeder compatibility with the structural material.

This group should propose and analyze low Z materials to be interposed between the plasma and the first wall. The design of the divertor plates (getters) should be performed by this group.

## 2.4 STRESS ANALYSIS

In the Stress Analysis group the calculations of the thermomechanical stresses in two and three dimensions will be pursued. The temperature distribution in the module is computed by the code FLHE, and the deflections and thermal stresses by means of the BERSAFE code.

A detailed analysis of the stresses induced by the electro-magnetic forces will be performed by this group in close collaboration with the groups of Frascati and University of Naples in charge of the calculation of the electric and magnetic fields distribution. The STRUDL-code will be used for the calculation of moment and force distribution starting from the map of current and magnetic field in the toroidal-poloidal coils, allowing the calculation of displacement and stresses in order to define the dimensions of the supporting structure of the coils.

## 2.5 SAFETY AND ENVIRONMENTAL IMPACT

A limited activity in this area has been performed in the past on the calculation of activation and afterheat.

This activity should be implemented and a group in charge of Safety Analysis and Environmental Impact should be formed. This group should analyze the hazards connected with normal and abnormal operation, promote a safety and reliability assessment of the system and of failure detection methods.

This group will provide the input for the design of the remote handling system for maintenance and repair.

## 2.6 PLANT ENGINEERING

The tasks of this group is the mechanical design of the reactor on the basis of the information provided by all the other groups. This group will analyze the compatibility of the proposed solutions from the point of view of assembly, disassembly, maintenance and renewal of the components.

In particular the design of the blanket modular structure will be the work of this group, together with the design of the supporting structure. The group will be in charge of the design of the tools for the remote handling for maintenance and renewal of the different components, of the study of the overall vacuum vessel and of the general layout of the reactor.

## 2.7 COST ANALYSIS AND POWER REQUIREMENTS

This group will undertake the cost analysis of the reactor including:

- The cost of major subsystems (TF and OF coils, vacuum vessel and equipment, neutral beam injectors and refueling system, blanket modules and shielding, electrical equipment, heat removal or energy conversion system, buildings, etc.);

- The cost of operation, maintenance and repair (in particular the replacement cost of features unique to a fusion reactor such as the first wall and the cryogenic system);
- The cost for the tritium handling equipment, initial tritium inventory and remote handling equipment.

### 3. PLANNING

CONCEPTUAL STUDIES ON THERMONUCLEAR FUSION REACTORS				
PLANNING	1977	1978	1979	1980
1. Parametric studies, (blanket nucleonics, heat transfer, materials and stress analysis)				
2. Analysis of Overall Plant Design and evaluation (safety, plant engineering, cost analysis and power requirements)				

### 4. MANPOWER AND COSTS

CONCEPTUAL STUDIES ON THERMONUCLEAR FUSION REACTORS				
	1977	1978	1979	1980
RESEARCH STAFF	8	8	8	8
INVESTMENTS (.KUA)	-	-	-	-
RUNNING COSTS (KUA)	30	30	30	30
CONTRACTS (KUA)	40	40	40	40
RESOURCES (.KUA)	-	-	-	-
EXPECTED INCOME (KUA)	-	-	-	-

## 5. CONNECTIONS WITH INDIRECT ACTIONS

This programme will be performed in close collaboration with CNEN (Frascati) and other laboratories of the EEC Fusion Associations, following the recommendations of the Liaison Group.

## 6. REFERENCES

- (1) F. L. RIBE; "Fusion Reactor Systems", Review of Modern Physics, vol. 47, No. 1, Jan. 1975
- (2) H. P. FURTH; "Tokamak Research", Nuclear Fusion, 15 (1975)
- (3) S. O. DEAN et al.; "Status and Objectives of Tokamak Systems for Fusion Research", USAEC Report WASH-1295 (1974)
- (4) K. A. BRUCKNER and S. TORNA; "Laser-Driven Fusion", Review of Modern Physics, vol. 46, no. 2, April 1974
- (5) "Two Component Torus Joint Conceptual Design Study", PPPL and WEC (1974)
- (6) "The JET Project", Design Proposal, EUR-JET-R5, May 1975
- (7) K. A. BRUCKNER et al.; "Laser-Driven Implosion of Spherical Shells", Nuclear Fusion, 15 (1975)
- (8) R. HANCOX; "Systems Studies of Proposed Fusion Reactors", CLM-P 434 (1975)
- (9) A. P. FRAAS; "Conceptual Design of the Blanket and Shield Region of a Full-scale Toroidal Fusion Reactor", Oak Ridge Nat. Lab., Report ORNL-TM-3096 (1973)
- (10) G. L. KULCINSKY et al.; "UWMAK-1, A Wisconsin Toroidal Fusion Reactor Design", University of Wisconsin Report UWFDM-68 (1973)
- (11) R. G. MILLS et al.; "A Fusion Power Plant", Princeton Plasma Physics Laboratory Report MATT-1050 (1974)
- (12) K. SAKO et al.; 5th Conference on Plasma Physics and Controlled Nuclear Fusion, Tokyo, p. G1-5 (1974)
- (13) R. A. KRAKOWSKY et al.; "An Engineering Design Study of a Reference Theta-Pinch Reactor (RTPR), Report LA-5336/ANL 8019
- (14) R. W. WERNER et al.; Workshop on Fusion Reactor Design Problems, Culham, p. 171 (1974)
- (15) L. A. BOOTH, Los Alamos Scientific Lab., LA-4858-SM (vol. 1) (1972)
- (16) R. HANCOX; 1st International School of Fusion Reactor Technology, Erice EUR-4999, p. 135 (1972)



- (17) BERTOLINI et al.; 5th Conference on Plasma Physics and Controlled Nuclear Fusion Research, Tokyo, p. G1-1 (1974)
- (18) S. FORSTER et al.; 2nd International School of Fusion Reactor Technology, Erice, EUR-5307, p. 364 (1974)
- (19) T.H. BALZER et al.; "Conceptual Design of a Mirror Reactor for a Fusion Engineering Research Facility , (FERF)" UCRL-51617, Aug. 1974
- (20) N. ABDOU et al.; "Engineering Design of an FTR and FERF Based on a Toroidal Theta-Pinch", IAEA 5th Conference on Plasma Physics and CTR, Tokyo, Nov. 1974
- (21) R. W. CONN and D. L. JASSBY; "A Tokamak Engineering Test Reactor", University of Wisconsin Report UW-FDM-119
- (22) W.M. STACEY et al.; "Tokamak Experimental Power Reactor Studies", ANL/CTR 75-2, Argonne Nat. Lab., June 1975, and P. G. SAGER et al.; "Conceptual Engineering Design Studies of a Fusion Experimental Power Reactor", ANS New Orleans Meeting (1975)
- (23) P.N. HAUBENRICH; "Tokamak Experimental Power Reactor: Basic Considerations and Initiation of Studies at Oak Ridge", ORNL-TM 4853, April 1975
- (24) C.C. BAKER; "Preliminary Study on Non-Circular Cross Sections Fusion Test Reactor", General Atomics Report (1974)
- (25) O. OZER, D. GARBER; "ENDF/B Summary Documentation", BNL 17541 and ENDF-201, Brookhaven National Laboratory, July (1975)
- (26) N. G. GREENE et al.; "AMPX: A Modular Code System for Generating Coupled Multigroup Neutron-Gamma Libraries from ENDF/B", ORNL-TM-3706
- (27) M. A. ABDOU et al.; "MACK: A Computer Program to Calculate Neutron Energy Release Parameters and Multigroup Reaction Cross Sections from Nuclear Data in ENDF Format", ORNL-TM-3994 (1973)
- (28) D. M. PARKIN and A. N. GOLAND; "A Computational Method for the Evaluation of Radiation Effects Produced by CTR-Related Neutron Spectra", Sept. 1974, BNL-50434.

## THE FINTOR GROUP

(Lab. Gas Ionizzati - Frascati) (JRC-Ispra) (Università di Napoli)  
 (CNEN Euratom)

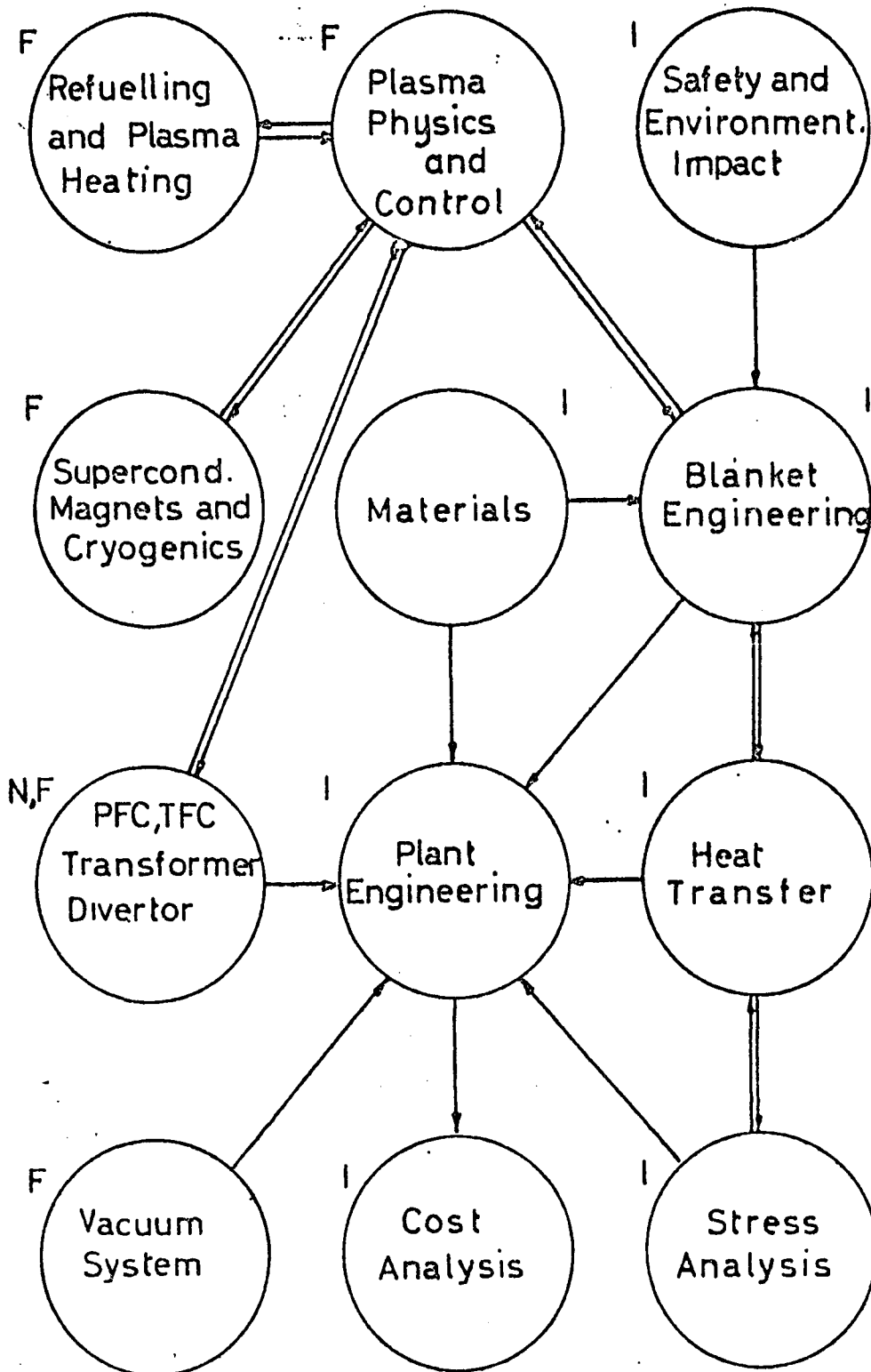

Fig. 1

## 7. HIGH TEMPERATURE MATERIALS

PROGRAMME :

HIGH TEMPERATURE MATERIALS.

TABLE OF CONTENTS

INTRODUCTION

1. BACKGROUND

2. DESCRIPTION OF PROJECTS.

2.1. PROJECT OF THE MEETING POINT PETTEN.

2.2. PROJECT ON THE EFFECT OF OPERATIONAL ENVIRONMENTS ON MECHANICAL PROPERTIES.

Thème 1 : Creep studies in carbonaceous atmospheres.

Thème 2 : The effect of coatings on the creep strength of some Ni-base superalloys.

2.3. PROJECT ON THE STUDY OF FAILURE MODES IN HIGH TEMPERATURE APPLICATIONS.

Thème 1 : The relationship between relaxation characteristics of niobium and tungsten containing alloys and their susceptibility to weld cracking.

Thème 2 : Investigation on the scatter of component lifetime and its relationship to material mechanical properties.

2.4. PROJECT ON THE STUDY OF THE RELATIONSHIP BETWEEN STRUCTURE AND PROPERTIES AND OF THE FUNDAMENTAL PROCESSES INVOLVED.

Thème : Composition and corrosion resistant properties of scales.

3. PLANNING.

4. MANPOWER AND COSTS.

5. LIST OF EXPERTS AND PAPERS PRESENTED.

PROGRAMME :

HIGH TEMPERATURE MATERIALS

INTRODUCTION

Up to now, European cooperation in the field of materials for high temperature applications has been very limited and has centred on advanced conventional alloys suitable for industrial applications up to 800°C (cf COST Project 12 on alloys for turbine blades).

Even on a world scale, the application of materials to high temperature processes has been restricted to cases where long life in highly stressed parts is not a major requirement, or where component failure can be tolerated without endangering the plant as a whole.

The new aims of industry, resulting chiefly from the increase in energy and raw material costs, make it desirable to consider the more efficient use of energy, including nuclear, in numerous industrial processes involving temperatures within the range 800-1000°C or even up to 1400°C, such as :

- a) Synthesis gases and fuels.
  - methane conversion,
  - conversion of heavy petroleum fractions,
  - gasification of coal and brown coal,
  - chemical decomposition of water.
- b) Iron and steel industry.
  - blast preheating in blast furnaces,
  - direct ore reduction.

c) Chemical industry.

- synthesis of methanol, ethanol, benzene and other aromatic compounds,
- ammonia synthesis,
- hydro-desulphurization.

In addition, recent changes in attitudes to environmental protection and conditions of employment are leading to the discussion of more stringent safety examinations in areas in which simple cost analysis was traditionally the criterion for public acceptance. Indeed, in some Member States, consideration is being given to the introduction of formal safety assessments before licences are granted for the installation of conventional industrial plant and equipment.

If long-term operation and reliability is taken into account, it should be possible to effect considerable savings through the use of improved materials.

It is intended, that this programme shall contribute to the Commission's progressive position in the development of European industry and the "Quality of Life", both by catalysing research and development in this field and by direct support of European national actions and Community programmes. These activities aimed at supporting the development of materials resistant to more stringent service conditions by understanding of the mechanisms governing their behaviour in appropriate environments and defining the conditions under which they can be employed. For example, technically available HTGR fuels could easily operate at a temperature two to three hundred degrees celsius higher than is permitted by the constructional materials of the associated plant.

In other areas of advanced technology, for example in industrial gas turbines, the temperature capability of materials restricts progress. The same observation is true of magnetohydrodynamic generators. That these requirements are recognized by manufacturers and international organizations was recently confirmed at the first Petten colloquium (1) on advanced high temperature materials. This brought together representatives from European industrial users, producers and research organizations, clearly expressed the desire for a close and continuous contact between relevant parties for the solution of key problems related to the reliable long-term application of high temperature metals, ceramics and composites.

SUMMARY OF MANPOWER AND COSTS

PROGRAMME : HIGH TEMPERATURE MATERIALS						
	Research staff (per year)	Investments (M.U.A.)	Total Running Expenditures (M.U.A.)	Resources (M.U.A.)	Required Budget (M.U.A.)	Expected Income (M.U.A.)
	36	1.390	0.820	-	2.210	-

(1) First Petten Colloquium on Advanced High Temperature Materials : Technological and Industrial Aspects. January 29-30, 1976, to be published as n°s 3 and 4 of the 1976 "Revue Internationale des Hautes Températures et des Réfractaires".

## 1. BACKGROUND

The current programme was defined in document COM 2200 (74) final and has been decided by the Council of Ministers on August 25th, 1975 (2) in the following terms : -

- "(a) Expert evaluation to assess industry's requirements for advanced refractory materials and the R and D programmes in hand in the Member States (and elsewhere in the world);
- "(b) Basic research as an extension of work already in progress in the JRC; the lines of this research would later be reviewed in the light of the priorities emerging from the survey;
- "(c) Applied research centred on industry-oriented subjects to be defined in the light of the survey results."

A number of experts xx) have been working closely with the Petten team, to clarify needs identified in the various fields of application, to define the materials requirements arising from these and to examine the conditions of operation.

Other consultants advise on the present situation and future prospects of existing and new materials in relation to their high temperature properties and behaviour under long-term service conditions in the environments encountered and identified above.

This work is supported by documentary research carried out by Petten staff, who prepared a general survey of the broad field. This subject has developed to the point where it was possible to hold a first colloquium to exchange ideas with those engaged in some of the more important institutes and organizations in leading industrial countries. The meeting has confirmed existing needs, introduced others, provided material for the so-called "white book" and enabled the first elements of a useful and relevant research programme to be established.

Another function undertaken, has been to establish a permanent series of contacts to discuss and collaborate on common problems and it is intended that this activity will evolve into one of maintaining and deepening the contacts already established in the present phase with research bodies, material development and supply companies, design and construction organizations, and plant operators.

(2) Official Journal of the European Communities Vol 18, N° L231, 2 Sept. 1975, p.15

xx) See list in section 5.

## 2. DESCRIPTION OF PROJECTS.

The projects proposed for the period from 1977 to 1980 are direct developments of activities being presently set-up. These activities result from the programme decision of the Council of Ministers in August 1975 and from the survey conducted under this heading. This survey has been made with the close assistance of European industry and research organizations.

Working parties composed of experts in the various fields under assessment and their collected conclusions and opinions will provide some of the material for the "White book" which will be published shortly.

Figure 1 is a flow sheet showing the interaction between the survey and the various activities arising from it : -

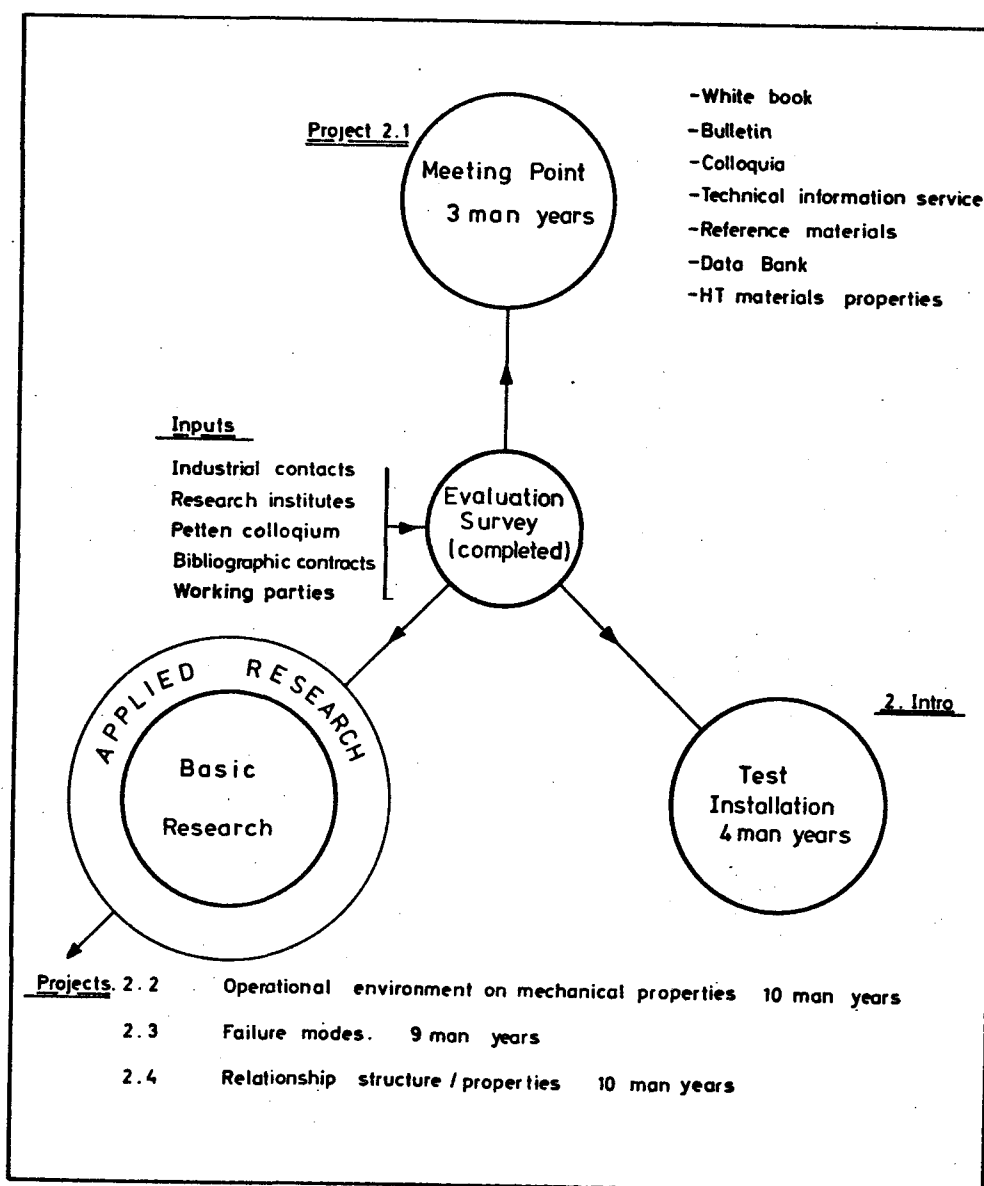



It is seen that the execution of the programme involves three types of activity : -

- a) To make at Petten a meeting point for HTM purposes (project 2.1.).
- b) To carry out a Research and Development programme on H.T.M. projects 2.2, 2.3, 2.4.
- c) To study specifications for a possible European test installation.

#### High temperature materials selected for initial attention.

High temperature materials at present in application or under consideration are mainly alloys based on iron nickel and cobalt with chromium to confer corrosion resistance, or ceramics, but also comprise for specialized purposes, the precious and refractory metals and their alloys.

In view of the present and future importance of the alloys based on iron, nickel and cobalt, and of the variety of their industrial applications, initial attention will be focussed in this direction. Such alloys are important in electric power generation, chemical processing, aerospace, metallurgical processing, electric heating and many other fields of high temperature technology in the temperature range 600- 1200°C, and consequently major attention will be devoted to these alloys.

The platinum metals are only employed in applications in which no other material is adequate, and where the extremely high cost can be tolerated, e.g. thermocouples, aircraft sparking plugs, glass industry. For the present, no action is proposed on such materials.

The refractory metals, principally tungsten, molybdenum, niobium and tantalum, have high melting points and high mechanical strength, but very poor oxidation resistance. Consequently they are currently used almost exclusively in non-oxidizing atmospheres, e.g. vacuum tube parts, including lamps filament, or in short-life applications where the oxidation is unimportant, e.g. rocket nozzles. The development of a reliable protective coating, well bonded to any of the refractory metals, would widen the scope for their industrial use and, in spite of the lack of success of previous efforts, it is planned to devote some attention to this problem.

Ceramic materials have conventionally been regarded as unsuitable for stress-carrying applications because of their inherent brittleness, but in recent years advanced ceramics with improved ductility such as silicon nitride and silicon carbide have been developed. These have possible applications, for example as gas-turbine blades. Some attention will be paid to these and similar materials with particular emphasis on the possibility of widening the fields of application.

Table I shows the present situation of the more important groups of refractory materials together with examples of their application and an indication of their relative volumes of usage.

TABLE I.

## SUMMARY OF HIGH TEMPERATURE MATERIALS - PRESENT POSSIBILITIES.

	Ferritic steels	Austenitic steels	Nickel alloys	Cobalt alloys	Platinum group metals	Refractory metals	Advanced ceramics
Maximum temperature for stressed parts, °C	550	700	1.000	1.000	1.500	2.000	2.500
Maximum temperature for oxidation resistance, °C	1.000	1.000	1.200	1.200	1.800	500	2.500
Typical examples	Steam-turbine parts.	Steam-and gas-turbine parts. Chemical plant. Reformers. Steam pipes.	Steam-and gas-turbine parts. Chemical plant. Reformers. Electric heating elements. Furnace parts. Welding electrodes.	Gas-turbine stator blades. Furnace parts.	Thermocouples. Glass processing. Crystal growing. Spark-plug electrodes.	Lamp filaments. Electronic valve parts Glass processing.	Experimental.
Importance :	B	A	A	B	B	C	C
A - very important							
B - special areas							
C - minor importance (based on tonnage and financial turnover)							

The following projects are proposed : -

PROJECT 2.1. : MEETING POINT PETTEN.

a) This project consists in :

- i) The continuous editing of a "white book", which reflects the "State of the art" on HTM related to "Research Activities" - "Applications" and "Industrial Problems". The first draft will be ready in April 1976. This document will be updated by the publication of supplements at two-yearly intervals.
- ii) The edition of a bulletin to be published quarterly.
- iii) A series of colloquia on specialized aspects of materials applications and technology will be held at Petten.
- iv) An information service will make available up-to-date references, abstracts of articles in the literature, etc .. This service will also act as an input to D. G. XIII's data bank on metallurgy.
- v) An action has been started to assess the rôle of reference materials and measurement methods in European industry with the aim of including this under the "METRE" action.
- vi) The possibility of creating a data bank of all the available data on high temperature materials and their properties will be explored.

b) Research and Development activities.

These activities at present resulting from the survey, will be subject to regular reassessment in view of developing industrial requirements. They are formulated under project headings 2.2, 2.3 and 2.4 from which typical themes of activities are given.

PROJECT 2.2 : EFFECT OF OPERATIONAL ENVIRONMENTS ON MECHANICAL PROPERTIES.

Theme 1 : Creep studies in carbonaceous atmospheres.

Almost all design of high temperature plant is based on the long-term mechanical properties of the constructional materials which have been determined in air. Discussions with engineers in the fields of heat exchangers, gas turbines, reformer plant and coal gasification converters, as well as nuclear reactors, have all revealed an urgent need for a better understanding of materials behaviour by a combination of mechanical loading under industrial environmental conditions.

A particularly important class of environment is that containing carburising gases. These are of wide industrial importance and range from low-carbon neutral atmospheres, e.g. helium-cooled nuclear reactors, to high-carbon atmospheres which may be reducing, e.g. gas carburising of steels, or oxidizing, e.g. oil quench furnaces.

The susceptibility of an alloy to carburisation, and the effect of this on its properties, depends on, i.e. the composition of the alloy, particularly on its initial carbon content. Thus it is proposed to study this subject, and the following procedure is envisaged.

A basic ternary alloy on the iron-nickel-chromium system will be chosen, possibly 30 Ni, 20 Cr ; balance Fe ; opinions vary as to the optimum carbon content of this and similar alloys, since higher carbon contents give higher creep strength but lower elongation at rupture.

Initial investigations would involve the following steps :

1. Atmosphere control. An instrument to measure carbon potential over a wide range is required and will be developed.
2. Experimental alloys. A range of alloys of constant composition, except for carbon content varying in steps from 0.01 to 0.5 per cent will be obtained.
3. Exposure to atmosphere. Samples to be exposed to atmospheres of different carbon potentials at different temperatures and for varying times to measure kinetics of reaction and equilibrium carbon levels.
4. Structural studies. Exposed samples to be examined by optical and electron microscopy, fluorescent X-rays and electron microprobe to establish phase constitution and morphology.
5. Mechanical properties. Measurement of creep properties, and destructive tests such as impact strength, tensile tests, etc . . . , will be performed on samples exposed to selected atmospheres at different temperatures for different times. <sup>x</sup> This requires the design and construction of facilities for testing a large number of test bars at the same time in the controlled environment. Until this is available (some months), a start will be made with carbon deposition and diffusion studies to form a basis for the interpretation of long-term mechanical behaviour.

This programme will be continued by work extending the compositional variation to cover the effects of :

- |       |   |
|-------|---|
| (I)   | Cr content  |
| (II)  | Ni/Fe ratio   |
| (III) | Additions of reactive elements e.g. Nb, Ti, Al, Zr. |

In addition, detailed studies in more complete environments such as encountered for example in figure 2 for nuclear process heat and chemical applications will complement the simpler studies in purely carbonaceous atmospheres.

x

See also appendix I.

Figure 2

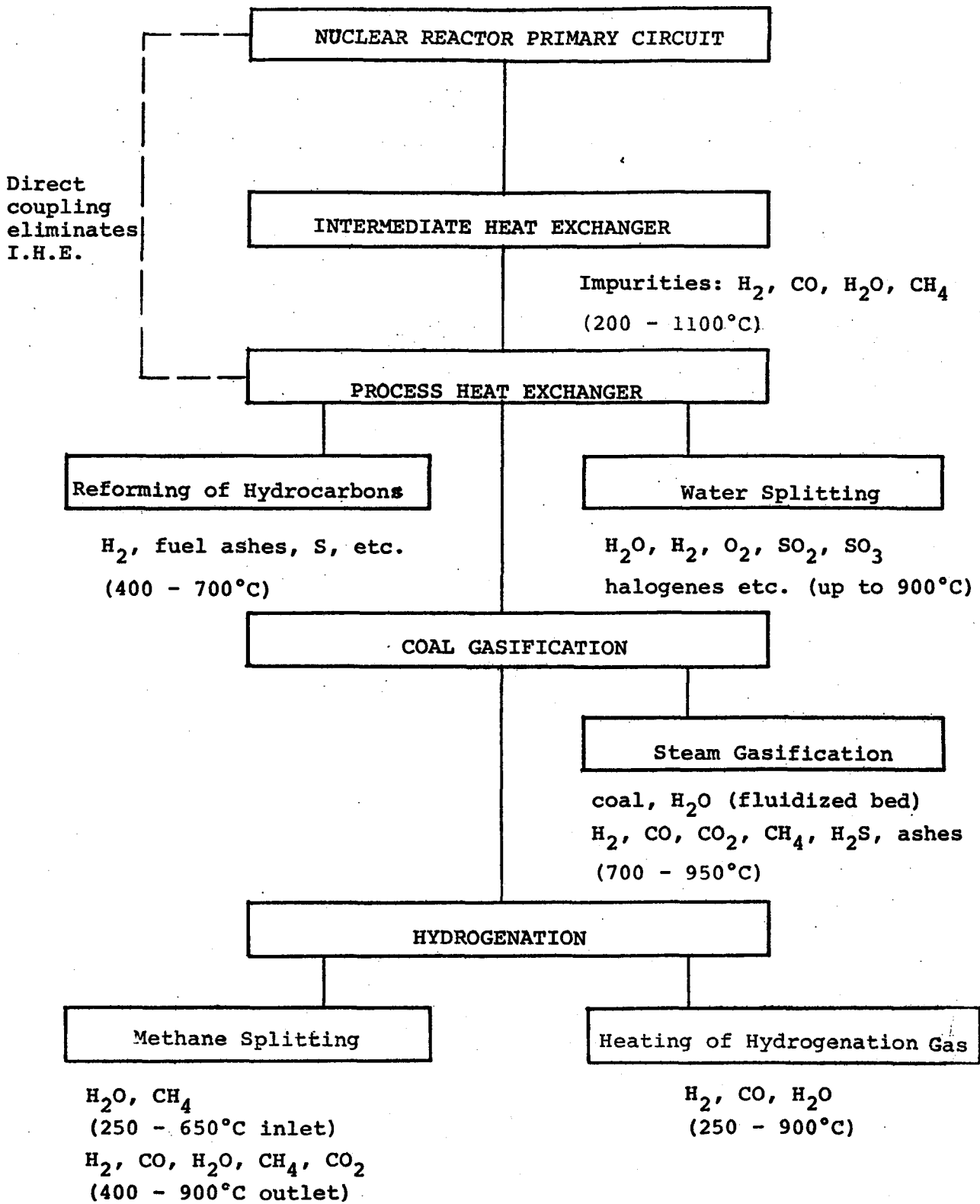

Theme 2 . : The effect of coatings on the creep strength of some Ni-base superalloys.

For applications where very high strength materials are required - as for example in gas turbines for military aircraft - Ni-base superalloys with low Cr-content (< 13 %) and rather high Ti + Al-content (> 10 %) are mostly used (e.g. IN 100). This composition range necessitates the application of certain coatings to provide these alloys with sufficient oxidation resistance for operation at high temperatures in very corrosive atmospheres due to the inability of these alloys to form inherent stable surface films.

Standard (thermogravimetric) oxidation tests have shown an improved oxidation resistance in the coated alloy ; however, extensive creep tests indicate that the coated material has a remarkably lower creep strength and a shorter lifetime than the same alloy without coating. This has been found for experiments in air as well as for tests under a hot gas environment.

The question arises if this feature is connected with :

- 1) changes of the structure of the base materials due to the heat treatment (temperature, atmosphere, diffusion of elements, etc ..) applied during the preparation of the coatings (diffusion processing) ;
- 2) possible interaction of the coating and the base material during service (high temperature, corrosive atmosphere, high stress);
- 3) dynamic effects such as thermal and load cycling.

The study envisaged will mainly involve structural investigations of the sample by means of metallography, EM, SEM, Auger-spectrometry (to determine concentration profiles of essential alloy elements), physical properties, X-rays, etc .. : -

- i) at various stages in the preparation of the coatings (in particular at the surface zone) ;
- ii) during creep testing, first in air, later in hot gas.

In addition, studies of the structure of ruptured specimens will be undertaken to investigate possible effects of the environment on either the coating or the base alloy.

Samples of material in the virgin and failed states will be obtained from interested manufacturers who are willing to provide hot gas testing facilities.

The scope of the study is to clarify the damaging mechanism and to define either appropriate heat treatments for the coating process or indications of the composition of the coating.

### PROJECT 2.3. STUDY OF FAILURE MODES IN HIGH-TEMPERATURE APPLICATIONS.

Practical operation of high-temperature plant necessarily leads, from time to time, to failure in service of certain components. These may be due to faulty design or material, faults in construction, operation outside the planned conditions, or to other unexpected happenings. A careful study of failures of any type and correlation of the observations with those made on laboratory samples tested under prescribed conditions, enables the cause to be established and steps taken to avoid a recurrence. It also provides evidence to guide the direction of development of materials with improved characteristics.

#### Theme 1 : The relationship between relaxation characteristics of niobium and tungsten containing alloys and their susceptibility to weld cracking.

One particular phenomenon which seriously inhibits the employment of the highest strength alloys in many fields is the cracking of welds. Welding is widely used in the construction of much high-temperature plant, particularly in boilers and heat exchangers of all types, chemical processing plant, etc.. The need to weld generally restricts the choice of materials to the lower strength alloys, since even when a more ductile filler metal is used, weld cracking commonly arises in the heat-affected zone (HAZ) of the parent metal when higher strength alloys are concerned. Niobium or tungsten containing alloys are particularly susceptible to HAZ cracking and this retards the adoption of such materials, which would otherwise be advantageous because of their better resistance to carburisation than titanium-containing alloys.

Weld cracking originates from thermal stresses generated by the temperature gradient in the vicinity of the weld and it is established that its prime cause is the impaired relaxation properties of the HAZ compared with the body of the metal, following re-solution of certain "precipitated phases" during the welding operation and re-precipitation as fine dispersion hardened structure during cooling.

Stress relaxation is essentially a creep phenomenon at constant strain, so that a high creep strength alloy is necessarily one which does not readily relax. Nevertheless, there is scope for the promotion of relaxation by appropriate choice of prior heat-treatment cycle, welding conditions and post-weld heat treatment.

In this programme of work, it is proposed to study the relaxation characteristics of a series of austenitic alloys of the same basic composition but with known differing weld-cracking susceptibilities, and to correlate these with cracking determined by established empirical procedures. The influence of prior and post-heat treatments will be studied in the attempt to establish a firm correlation.

It is expected that although the practical significance of the findings will generally be specific to the particular alloy studied, nevertheless if a relationship can be established, it should aid in the selection of procedures to avoid HAZ cracking more generally and hence to widen the applicability of susceptible material.

Theme 2 : Investigation on the scatter of component lifetime and its relationship to the properties and structure of the material of origin.

When applying creep information to the design of practical components, the conventional characteristics "time to rupture" and "time for a given elongation" are employed ; being obtained from experimental data. In operational service however, component performance differs significantly from that predicted from the material characteristics, and this discrepancy has important technological and economic repercussions.

The source of such scatter is to be sought in the different structures resulting from the alloy production processes. The fact that nominally identical alloys produced by different manufacturers, various batches of the same alloy or even components fabricated from material obtained from the same batch can show differing behaviour, is recognized as a general problem in all fields of high temperature technology. The problem is exaggerated as more extreme operational conditions are encountered (e.g. temperature, stress, environments). In addition, the trend towards more rigorous safety regulations has to be taken into account, particularly in the nuclear and aircraft industries. The scatter problem is generally solved by the application of appropriate safety factors with their implication of undesirable waste of material and even design limitations (e.g. weight or thickness increases, ..).

The study will begin with an intensive investigation of all structural and physical properties of specimens of two representative alloys (e.g. IN 718, waspalloy), which have been proved to have extreme mechanical properties after production. Creep tests under operational atmospheres and in air will be carried out and the structure monitored at frequent intervals. Results obtained will be compared with those coming from components made from materials falling within manufacturing tolerance that have failed in service. Suitable specimens have been promised by various component manufacturers and users. Attention will be paid to the possible influence of experimental errors in the measurements and the effects of specimen size, related to grain size, precipitate size and distribution and other factors concerning the material batch, component dimensions, etc ...

The aim is to define a means of improved mechanical characterization for the materials, and identify the critical production parameters (e.g. heat treatment, compositional control, coatings, minor impurities, etc ..), and so be able to recommend specification improvements.



PROJECT 2.4. STUDY OF THE RELATIONSHIP BETWEEN STRUCTURE AND PROPERTIES, AND OF THE FUNDAMENTAL PROCESSES INVOLVED.

This study is intended to facilitate the prediction of long-term behaviour under service conditions. The work will include the acquisition of diffusion data, phase equilibria and the kinetics of the approach to equilibrium. Measurements will be related to certain elements that play a major rôle in the properties and behaviour of high temperature materials, not only the interstitial elements such as hydrogen, carbon, nitrogen, oxygen and boron, but also the more important substitutional elements such as silicon, and other metals. Attention will be directed to the accumulation of certain elements in the grain boundary, either as discrete precipitates or in solid solutions.

Deformation and fracture phenomena under stress at temperatures where atoms are diffusing significantly are much influenced by precipitate morphology. When the precipitation occurs in service from atoms diffusing from the surface into the alloy, it has particular significance to the life of components. A special study of the surface reactions and metal structures arising from carbon diffusion will be made initially in various industrial alloys.

Service life in many applications is influenced by the formation of protective oxide surface scale and the use of artificial coatings. A major problem here is cracking and spalling and loss of adhesion to the substrate. These latter phenomena, and their relation to scale plasticity and other properties need extensive study.

Theme . . : Composition and corrosion resistant properties of scales.

It is well known that the resistance against corrosion of a high temperature alloy or a coating depends upon its ability to form a protective scale. High temperature alloys usually have to be chosen from their thermomechanical specifications rather than from their corrosion performances and the protective function is often transferred to coatings of various kinds. This results in a composite material system comprising the base alloy, the coating and the scale.

Scale integrity has a critical influence on component lifetime and damage to scale occurs in four principal ways : -

- a) By chemical action.
- b) By mechanical action (e.g. erosion, vibration, etc ..).
- c) By thermomechanical action (e.g. influence of rapid changes of temperature).
- d) Simultaneous attack by all three ways.

An initial study on scales would determine the effects of corrosive environments on scale morphology and protective properties, to explore the possibilities of adjusting scale properties by changing the composition of alloys or coatings. This can be accomplished by modification of the alloy composition by minor additions of metals or oxides and the application of protective coatings. Experiments will include the determination of scale composition, phases and morphology using optical and electron microscopy including SEM, X-ray diffraction and electron microprobe analysis. Scale formation will be studied with the aid of thermobalances (sensitivity  $10^{-6}$  g), where the sample can be tested in appropriate corrosive atmospheres.

Plasticity and adherence of scales will be investigated by scanning electron microscope (SEM) with hot stage facilities. Spalling will be assessed by e.g. mechanical and thermomechanical treatments followed by structural examinations.

APPENDIX I.TEST FACILITY.

The current programme includes the study of a possible test facility of European dimensions. Studies will be pursued in order to propose a programme revision during the 1977-1980 period dealing with the construction of such a test facility.

First enquiries with possible industrial users show interest in the following types of installation : -

1. Materials producers - high temperature testing unit for small samples.
2. Plant designers - high temperature materials in the form of component, weldments, tubes, etc ...
3. Constructors - Large scale test facility for complete assemblies.

These needs could be met in the following way :

Installation 1, which initially serves the needs of the Petten programme, would be extended to supply the lack of creep testing facilities able to work under controlled environments for use by interested parties.

Installation 2 would have to be a very versatile equipment and consultations are in hand with specialist engineers as to its possible form and practicality. Before finalizing the specification, a meeting will be held with potential partners to optimize the requirements and operating conditions.

Installation 3 is under initial study in the form of a large loop for testing heat exchanger bundles under realistic conditions of temperature and mechanical and chemical environment.

Together the three installations constitute a facility for the complete testing of materials and components and each separate part is in itself a valuable contribution to European industrial research and development.

3. PLANNING.

This programme is a continuous activity during the period 1977-1980.

4. MANPOWER AND COSTS

PROGRAMME : HIGH TEMPERATURE MATERIALS				
	1977	1978	1979	1980
RESEARCH STAFF	36	36	36	36
INVESTMENTS (K.U.A.)	490	300	300	300
RUNNING COSTS (K.U.A.)	160	160	160	160
CONTRACTS (K.U.A.)	45	45	45	45

## 5. LIST OF EXPERTS AND PAPERS PRESENTED

### Requirements of Established Technologies

Chemical and allied industries :

G. Swales (The International Nickel Co. Ltd.) :  
Materials selection considerations for petrochemical furnace tubes.

C. Edeleanu (I.C.I.) :  
Chemical industry aspects.

Metallurgical industries :

J.H. Davidson (Le Creusot-Loire) :  
High temperature materials requirements of the metallurgical industries.

Aeronautical industries :

P. Esslinger (Motoren-Turbinen-Union) :  
Development of materials used in gas turbine engines, R/D guide lines  
and proposals for a priority scheme.

### Requirements of High-Temperature Reactors

Primary cooling circuit, helium turbines :

L.W. Graham (Dragon) :  
Materials for advanced high temperature reactors.

Process heat applications :

H.F. Niessen et al. (K.F.A. Jülich) :  
High-temperature materials requirements in reforming of gaseous hydro-  
carbons with HTR heat.

R. Huddle and H. Fricker (Sulzers Ltd.) :  
Metallurgical problems of the He-to-He heat exchange for advanced HTR's.

K.H. van Heek (Bergbauforschung), P.G. Kalwa (Mannesmann), W. Wanzl  
(Bergbauforschung) :  
Materials for steam gasification of coal with HTR heat.

### Requirements of Advanced and Future Energy Conversion Systems

Mme Anthony (CNRS Orléans) :  
High temperature materials requirements of the magneto-hydrodynamic  
energy conversion.

J. Bressers (JRC Petten) and W. van Witzzenburgh (RCN Petten) :  
High temperature materials requirements of the fusion reactor technology.

Mme Coen (JRC Ispra), G. Imarisio (JRC Ispra) :  
High temperature corrosion in the thermochemical hydrogen production  
from nuclear heat.

Materials Aspects

J. Stringer and D.P. Whittle (University of Liverpool) :  
Oxidation and hot corrosion.

C.D. Des Forges (Fulmer Research Institute Ltd.) :  
Metals and alloys for high-temperature applications.

M. Mocellin (Ecole des Mines de Paris) :  
Ceramics for high temperature applications.

R. Ubank (Rolls-Royce Ltd.) :  
Coatings and diffusion barriers at high temperature.

8. ENVIRONMENT AND RESOURCES



PROGRAMME  
ENVIRONMENT AND RESOURCES

TABLE OF CONTENTS

INTRODUCTION

1. PROJECT: ATMOSPHERE

1.1. SUBPROJECT: PARTICLE FORMATION AND TRANSPORT OF POLLUTANTS

1.1.1. Background

1.1.2. Technical Description

1.1.2.1. Test areas

1.1.2.2. Chemical and physical analysis

1.1.2.3. Field measurements and experiments

1.1.2.4. Laboratory experiments

1.1.3. Related studies

1.1.3.1. Uptake of SO<sub>2</sub> by Plants and Soil

1.1.3.2. Urban Air Quality Modelling

1.1.4. Planning

1.2. SUBPROJECT: ILE-PATHWAY OF AUTOMOTIVE LEAD

1.2.1. Background

1.2.2. Technical Description

1.2.2.1. Atmospheric Lead

1.2.2.2. Transfer Pathways

1.2.2.3. Contribution to Absorption in Man

1.2.2.4. Distribution in the Ecosystem

1.2.2.5. Sampling Scheme

1.2.3. Planning

1.2.4. Connection with Indirect Actions

1.2.5. Association with External Organizations

1.3 MANPOWER AND COSTS

- 2. PROJECT: WATER
- 2.1. SUBPROJECT: EUTROPHICATION
- 2.1.1. Background
- 2.1.2. Technical Description
- 2.1.3. Planning
- 2.2. SUBPROJECT: EURASEP INVESTIGATIONS ON SEA AND AIR POLLUTION ON SOME COASTS AND CITIES OF EUROPEAN COUNTRIES OF THE E. E. C.
- 2.2.1. Background
- 2.2.2. Technical Description
- 2.2.2.1. Marine Pollution
- 2.2.2.2. Atmospheric Pollution
- 2.2.3. Planning
- 2.2.4. Contracts
- 2.2.5. Connections with the "Environment Indirect Action"
- 2.2.6. Connection with External Organizations
- 2.2.7. Existing Competences and Previous Experience in Europe
- 2.3. SUBPROJECT: ECOLOGICAL EFFECTS OF CHEMICAL AND THERMAL POLLUTION IN WATER BODIES
- 2.3.1. Background
- 2.3.2. Technical Description
- 2.3.3. Planning
- 2.4. MANPOWER AND COSTS
  
- 3. PROJECT: CHEMICALS
- 3.1. SUBPROJECT: ECDIN (ENVIRONMENT CHEMICALS DATA AND INFORMATION NETWORK )
- 3.1.1. Background
- 3.1.2. Technical Description
- 3.1.2.1. Present Work
- 3.1.2.2. Description of Future Work
- 3.1.3. Planning
- 3.2. SUBPROJECT: MOBILIZATION OF HEAVY METALS FROM FOSSIL-FUELLED PLANTS AND ECOLOGICAL-BIOCHEMICAL IMPLICATIONS
- 3.2.1. Background
- 3.2.2. Technical Description
- 3.2.2.1. System Modelling and Definition of Methodologies and Research Priorities
- 3.2.2.2. Heavy Metal Emission from Coal-fired Power Plants
- 3.2.2.3. Ecological Transfer studies
- 3.2.2.4. Metals Biochemistry and Metabolic Patterns of Heavy Metals

3.2.3. Planning

3.2.4. Connection with External Organizations

3.2.5. References

3.3. SUBPROJECT: FOLLOW-UP COST 64b AND OZONE DEPLETION  
BY HALOCARBONS

3.3.1. Follow-up cost 64 b

3.3.1.1. Background

3.3.1.2. Definition of the problem

3.3.1.3. Technical Description - Outline of the new Project

3.3.1.4. Contributions of the JRC

3.3.2. Ozone Depletion by Halocarbons and other substances

3.3.2.1. Background

3.3.2.2. Technical description

3.3.3. Planning

3.4. MANPOWER AND COSTS

4. PROJECT: AGRICULTURAL RESOURCES

4.1 SUBPROJECT: POST "AGRESTE" PROJECT

4.1.1. Follow-on and Conclusion of the "AGRESTE" Project

4.1.2. Investigation of Crop Stress and Diseases by Means of  
R.S. Techniques

4.1.2.1. Background

4.1.2.2. Technical Description

4.1.3. Publications Concerning "AGRESTE" project

4.2 SUBPROJECT: TELLUS

4.2.1. Background

4.2.2. Technical Description

4.2.2.1. Soil Moisture

4.2.2.2. Heat Budget

4.2.2.3. Remote Sensors and Platforms

4.2.2.4. Statement of Work

4.2.2.5. Data Processing

4.3. PLANNING

4.4. MANPOWER AND COSTS

PROGRAMME  
ENVIRONMENT AND RESOURCES

INTRODUCTION

The principal scope of this programme is to provide, together with the indirect action,\* scientific support to the Communities' Action Programme on the Environment.\*\*The following table gives a synoptic view of the major links of this programme with the Indirect Action and the Action Programme.

The first project deals with research on the phenomena of particle formation, on its relation to air pollution and its dependence on the transport and dispersion of pollutants. The completion of related studies on SO<sub>2</sub>-uptake, urban air modelling and the pathway of automotive lead is also envisaged.

The second project involves investigations into basic eutrophication phenomena, on marine pollution using remote sensing techniques (EURASEP Project), and certain biological effects of thermal shocks on water populations.

The third project comprises the continuation of the pilot project related to the Environmental Chemical Data and Information Network (ECDIN), together with a study on the mobilization of heavy metals and their ecological and biochemical implications, and the follow-up of COST 64 b\*\*\*together with analysis on halocarbons.

The fourth project involves the conclusions of the AGRESTE programme (Agricultural Resources Investigation in Southern France and Northern Italy) as well as the beginning of a new investigation of the soil moisture and heat balance in selected European zones (TELLUS Project). For these studies the use of data obtained from NASA satellites (LANDSAT-3, EXPLORER-A) and airborne scanner flights is envisaged.

The following chapters describe the four projects in detail, together with provisional indication of the manpower and costs.

---

\* Doc. Council, 9 March 1976, R/578/76

\*\* Doc. Council, 24 March 1976 - COM(76)80 final

\*\*\* Analysis of Micro-Pollutants in Water

RESEARCH PROGRAMMES

9.3.1976

ENVIRONMENT & RESOURCES

ENVIRONMENT

Project proposals 2nd programme direct action (77-80)

Programme areas 2nd programme indirect action (76-80)

Programme of Action on Environment (73)

PROJECT 1 ATMOSPHERE

Particle form. & transport of poll.
SO2 uptake by plants and soil
Urban air modelling
ILE (pathway of automotive lead)

PROJECT 2 WATER

Eutrophication
EURASEP (Nimbus G)
Ecol. effects heat & temp. in water

PROJECT 3 CHEMICALS

ECDIN
Heavy metals (from coal)
Follow-up COST 64b / freons

PROJECT 4 RESOURCES

Post-AGRESTE (diseases)
TELLUS (Explorer A)

1 Res. for establishment of criteria documents

- a) identification and meas. of pollutants
b) their evolution and transformation
c) their metabolism and effects on targets

1.1 Heavy metals

1.2 Organic micropollutants

1.2.1 Pathway of fluoro- and chloro-hydrocarb.

2.1.5 Air quality

1.5.1 appl. and testing of remote sensing m.

1.5.2 physico-chemistry of air pollution

1.5.3 modelling of air pollution dispersion

2.1.7 Thermal pollution, Ecological and micro-

2.1.8 Marine pollution

development methodologies for monitoring coastal water quality; a) transport modelling b) use of remote sensing techniques

2 Environmental information management (EODIN)

3 Prevention and reduction of pollution & nuis.

4 Improvement of the environment

2.4.1 Oriented basic research on disturbances of ecosystems caused by man

2.4.3 Application of remote sensing techniques for the study of envtl. disturbances

II/I Measures to reduce pollution and nuisances

- 1) Objective evaluation of risks to man and environment from pol.
3) Specific actions on env. pollution.
4) Measures relating to certain products (e.g. PCBs)
5) Actions specific to certain industrial sectors and to energy
6) Marine pollution ...

11 Dissemination of knowledge relating to environment protection

II/II Action to improve the environment

Agriculture

Directives for better management of agricultural resources:

- assistance to less favoured zones (1975)
- co-ordination of agricultural research programmes (1975)

COST 61 a

COST 64 b

COST 68

SUMMARY OF MANPOWER AND COSTS

PROGRAMME : ENVIRONMENT AND RESOURCES							
	Research Staff (per year)	Invest- ments (M.U.A.)	Total Run- ning Expen- ditures (M.U.A.)	Resources (M.U.A.)	Required Budget (M.U.A.)	Expended Income (M.U.A.)	
<u>PROJECT 1</u> ATMOSPHERE	37.5	0.500	0.630	---	1.130	---	
<u>PROJECT 2</u> WATER	23.5	0.500	1.100	---	1.600	---	
<u>PROJECT 3</u> CHEMICALS	34	0.220	0.930	---	1.150	---	
<u>PROJECT 4</u> RESOURCES	20	0.600	0.530	---	1.130	---	
TOTALS	115	1.820	3.190	---	5.010	---	

## 1. PROJECT: ATMOSPHERE

### 1.1 SUBPROJECT: PARTICLE FORMATION AND TRANSPORT OF POLLUTANTS

#### 1.1.1 Background

The existence of particles in the atmosphere has been known for a long time. It was realized very early that these particles gave rise to different kinds of atmospheric phenomena. One of the most obvious effects of particles in the atmosphere, but not the most disturbing one, is visibility reduction, which reaches from the extreme manifestation in fog (a special case, because the particles are pure water droplets) to the more or less pronounced situations generally classified as "haze". Such widespread turbidity of the atmosphere is frequently observed in many parts of the world and is sometimes clearly connected with anthropogenic activities (city smog) but also occurs in very remote regions, e. g. mountain areas, forests.

Visibility is considered by some countries as an air quality factor and they have adopted standards for its control.

For California, the air quality standard defines a visibility of not less than 16 km at a relative humidity below 70%. Fog, smog and haze situations are common in many parts of Europe and have increased in the past decades both in intensity and frequency. In parts of the Po-Valley for example, a 50% increase, since 1960, in the number of days with rather dense haze in summer, has been reported.

As outlined above, in Central Europe widespread air pollution is probably to a certain extent always involved in particle formation. In addition, dangerous pollutants might be preferentially absorbed by haze particles and give rise to synergistic effects or diseases of the respiratory tract. Even though no acute health effects have been encountered till now, a long-term influence is not to be excluded, especially if the haze situation becomes more severe. A knowledge of the overall phenomena and their future trends would therefore be an important basis for taking future decisions with regard to air pollution control and the impact of larger power stations. Increasing particle formation might in the long run have consequences on the climate in general.

Turbidity of the atmosphere is caused by the scattering of sunlight on small aerosol particles. Only particles in the size range from 0.1 - 1.0 microns are optically active in this respect. The biologically active fraction reaching the lung is also in the submicron

Sources and origin of these particles have to a minor extent clearly been identified. Their chemical composition and micro-structure have not been systematically investigated and therefore most of the mechanisms of formation and disappearance are only speculative.

The intense research work dedicated to the problem of photochemical smog formation in cities, strictly connected to automobile traffic, and the achieved results, have triggered the first attempts to understand haze particle formation. In general, it has been demonstrated that vegetation, especially forests, can be an important source of hydrocarbons which are similar, in their potential smog forming reactivity, to those released by car exhausts. The rate of production and the total amount of these plant "exhausts" were estimated to exceed on a larger scale those from human activities. In analogy with the smog forming process, photochemical reactions would produce the haze particles from the organic volatiles.

Organic vapours and other trace gases might be released also from the soil. The frequent renewal of ground surface in agricultural practice has been blamed by Japanese scientists as responsible for increased particle concentrations.

#### Transport Aspects

Air pollution by anthropogenic activities is inevitably involved in most parts of the northern hemisphere. Widespread effects from automobile traffic and heating are probably much more relevant in this context than direct particle pollution from industries. Besides hydrocarbons and other organic materials, an appreciable influence on particle formation might be expected from inorganic pollutants like nitrogen oxides and sulphur dioxide. These gases have been shown to be of eminent importance in smog-formation. In this respect, the release of pollutants from large power stations could become an important contribution to particle formation in those areas to which the pollutants are transported.

Therefore, it is important to gain more knowledge of the physical interactions between the synoptic scale meteorological conditions and locally induced circulation and to study the temporal and spatial variation of dispersion parameters in a region.

Present and future remote sensing techniques, together with the systematic use of "ad hoc" tracer experiments are likely to help in obtaining much instantaneous data under different classified meteorological conditions and to control transport and diffusion phenomena by a material input-output balance. The results of these



measurements will be useful to refine and/or control interpretative models which at present, in most cases, in particular meteorological conditions favourable for particle formation (e. g. low wind speed), are rather unreliable because they are based on relatively scarce sets of data for the interpretation of diffusion and transport phenomena.

Situations of increased particle formation are very often connected with the occurrence of very stable thermal inversion layers, where sun irradiation is intense and mixing, mostly vertical, caused by day-night cycle and turbulence. Considering also that haze formation takes place almost simultaneously in relatively large areas, this would indicate intense local production of the particles. At the same time, local sinks and dry deposition are obviously less effective. On the other hand, some observations report the transport of hazy air masses from far away, which then persist for days under more stable weather condition.

Ozone is known to be transported not only from higher altitudes to the ground by injections of stratospheric air into the troposphere but also by horizontal movement of air masses from polluted areas. As ozone is capable of producing particles with organic compounds in a gas-gas reaction, even in the dark, its large-scale occurrence in the lower atmosphere could be a critical parameter.

Furthermore, there is the possibility of the transport of natural or man-made particles having diameters below the optically effective size (condensation nuclei) whose subsequent contribution or participation in haze formation is an open question.

The mechanism of the formation of particles from the different organic and inorganic trace gases is certainly a very complex interaction of many chemical and photochemical reaction steps. After many years of rather intensive work on photochemical smog formation in cities, its mechanism is still only partly understood.

Of major importance in this chemical process is the presence of nitrogen dioxide in exhaust gas, which, by absorbing in the visible region of the sun's radiation, starts a chain reaction of consecutive chemical reactions among and partly with the other gases.

As a result of these reactions, a build-up of oxidized organic material and of ozone and other oxidants takes place, the visibility is reduced and in extreme cases medical effects like eye irritation are reported. The concentration of ozone sometimes reaches values not normally found in the lower atmosphere. The quantity of smog produced in this way depends directly on the concentration of exhaust gas and the intensity of the sunlight.

A photochemical mechanism of this kind might well be involved also in the formation of haze particles. As varying amounts of exhaust gases are found virtually everywhere, haze is probably always mixed with smog and a clear separation of the two phenomena might lose its significance. It came only partly as a surprise, when recently, the chemical compound responsible for eye irritation in smog (PAN), was also detected in a rather rural area (Harwell, UK).

A critical parameter will be without any doubt the natural and man-made amount of nitrogen oxides. Efficient anthropogenic sources of these gases, like large conventional electrical power plants, could therefore be critical in areas where large emissions of natural or man-made organic materials are present. Haze particle production is quite clearly related to the intensity of sunlight too. But besides the photochemical reaction on the nitrogen dioxide, the ultra-violet part of the sunlight could produce numerous other photochemical reactions and reaction cycles. The available intensity at different wavelengths and under different zenith angles of the sun, especially in the ultra-violet region, is only one of the relatively unknown parameters in this context. Another contribution to increased particle formation under intense sunlight could be the accelerated release of reactive gaseous material from soil or vegetation by pure heating up or enhanced photosynthesis effects followed by gas-gas reactions.

#### Effects

Little or no research has so far been dedicated to the important problem of pollutant effects connected with haze situations. It is worthwhile to mention here that experimental evidence suggests pollutants especially polycyclic aromatic hydrocarbons from heat and power generation, refuse burning, industrial processes and motor vehicles can produce lung cancer in animals (at higher concentration than normally occurs). Gaseous and particulate air pollutants can both initiate and aggravate a variety of respiratory diseases, including asthma. A thorough understanding of the particle haze phenomenon is a pre-requisite for the studies of such problems.

Though the direct connection of turbidity with high particle concentration has long been known, only a limited amount of research has been dedicated to problems of haze formation in the past. At present, only a few institutes are probably able to treat the whole aspect of haze. The reason is mainly that a combined effort of meteorology, atmospheric physics and air chemistry is needed, together with the appropriate instrumentation and techniques. In

the framework of its Environmental Research Programme, the JRC has acquired and developed methods and experimental equipment, which in addition to appropriate "extra muros" contracts, can be very efficiently combined for such a programme.

At the JRC experience has been gained especially in the following fields or techniques:

- photochemical decomposition of organic compounds under simulated atmospheric conditions,
- analysis of organic volatiles in air by Gas Chromatography-Mass Spectrometry-computer (multidetector unit);
- aerosol measurements;
- remote sensing with LIDAR, SODAR, IR-absorption, correlation spectroscopy for measurements of gaseous pollutants (e. g.  $\text{NO}_x$ ,  $\text{SO}_2$ ) and meteorological parameters as inversion layers, turbulence, vertical wind profiles;
- tracer experiments ( $\text{SF}_6$  etc.).

The Ispra Centre is, due to its location in the greater Po Valley area, in a favourable position for research on particle formation. Here haze is not only very dense and persistent, but it occurs throughout the year, and is especially frequent in summer.

Thermal inversion layers stabilize the haze situation to such an extent, that nearly steady state conditions are reached. This is an enormous advantage, because several field parameters remain constant for certain periods of time. This resembles laboratory conditions, difficult to simulate artificially. Furthermore, frequent "föhn" events, especially in winter and spring, characterized by very high wind speeds and very low humidity, flush the whole atmosphere in large areas of the valley to conditions of very high visibility and rather low pollutant content. As soon as the air stabilizes, the new build-up of haze conditions with time can be followed starting from practically zero conditions.

Haze with the same basic characteristics also occurs elsewhere in Europe, e. g. in the Upper Rhine Valley. Measurements from such locations will be necessary during the programme to test the general applicability of a locally developed particle formation model, but experts in the field are already convinced that this will be the case.

Maritime haze, being basically different in nature, is at present not included in this context.

### 1.1.2 Technical Description

In the field of air chemistry usually the classical pollutants (SO<sub>2</sub>, NO<sub>x</sub>, aerosols of industrial origin) or the car exhaust gases, which under certain conditions can lead to "smog" formation, are studied. Only recently was discovered the important role of natural emissions from soil or vegetation in particle formation which leads to more or less dense hazes.

It is proposed to study both the influence of these natural products and of anthropogenic compounds and their mutual and/or joint impact on the formation of aerosols. The majority of the field studies will be carried out in the Po Valley. The research will include the following topics:

- A detailed chemical analysis of the natural organic and anthropogenic constituents of the air, including those contained in the aerosols; in 4 model areas;
- Measurement of background of inorganic gases which can undergo photochemical reactions with the afore mentioned compounds;
- Inventory of the major pollutant sources in the greater area to be studied, including the emissions of conventional power plants;
- Investigation of the mechanisms of transport and diffusion of the afore mentioned pollutants as a function of the different meteorological stabile classes;
- Chemical and physico-chemical description of haze and its mechanisms of formation and disappearance by:
- Correlation of field analysis data with field measurement data and by a continuous improvement of the underlying hypothesis and evolving theories in a permanent feedback process with laboratory research on the relevant chemical and photochemical reactions.

#### 1.1.2.1 Test Areas

Four test areas are proposed:

1. A rural area with forests in the Po Valley, remote from urban and industrial zones, to study the natural emissions;
2. The greater Ispra area, to study the combined effect of natural emissions and anthropogenic pollution transported essentially from the Milan area;
3. A rural area with a conventional power station;
4. Possibly for comparison a test area in the Upper Rhine Valley.

For reasons of economy the majority of the field experiments will have to be made in the Ispra area.

### 1.1.2.2 Chemical and Physical Analysis

This includes in-field and laboratory measurements of both chemical constituents and particles. The third dimension will be covered as far as possible by remote sensing techniques. It is also intended to mount a series of instruments on the cable-car Laveno-Sasso di Ferro which reaches an altitude of 900 m, for vertical profile measurements (radio transmission of signals).

The reactive inorganic gases NO, NO<sub>2</sub> and O<sub>3</sub> (ozone) will be determined on ground by chemiluminescence methods; the commercial instruments are specific and have continuous and real-time readings. SO<sub>2</sub> and pH measurement will also be done with available instruments. Remote measurement of NO<sub>2</sub> will be done by Dual Wavelength Absorption Spectroscopy (DAS) and of SO<sub>2</sub> by correlation mask spectrometry and the Raman Lidar technique. A decision on whether to measure NH<sub>3</sub> is still open.

The organic analysis of gases and solids will be focused around the multidetection unit developed during the first programme (GC-MS-computer). The long absorption of the tunable IR-laser beam may also be used here.

The full array of instruments for the measurement of condensation nuclei, cloud condensation nuclei, particles in the 0.1 micron range and larger particles, is available. The Lidar technique will also be used for these measurements (0.1 - 1  $\mu$ ) wherever possible. The integral density of haze in the vertical direction could be measured by remote sensing from the LANDSAT satellites using the prealpine lakes as reflectors.

Visibility is normally measured via measurement of the scattering coefficient. Commercially available instruments allow only point measurements.

Total ultra violet radiation (sun and sky 290 - 385  $\mu$ m): In addition an analysis of the spectral energy distribution in the ultra-violet region must be made and its change under the influence of an inversion layer (haze) and with respect to varying zenith angles of the sun, must be studied.

This distribution might be an important parameter for photo-chemical processes in the ultra violet region. These measurements must be extended also to the spectral range, responsible for the important chemical olcavage of nitrogen dioxide. The efficiency of the global radiation for this reaction can be measured by using nitrogen dioxide itself as dosimeter.

### 1.1.2.3 Field Measurements and Experiments

They essentially refer to problems of pollutant transport and diffusion. Besides the chemical and physical parameters, also the relevant meteorological parameters will be measured continuously or at least during significant weather periods. For an area of nearly equal meteorological and environmental conditions one measuring site is sufficient, possibly to be complemented by the measurement of selected parameters in other test areas.

The classical meteorological parameters, temperature, pressure, relative humidity, wind, sunshine, precipitation, will, of course, have to be monitored. Special attention must be given to the measurement of very low wind speeds (1 m/s) in order to detect air parcel shifts and resulting partial mixing during thermal inversions. Sunshine intensity must be monitored continuously. Föhn events must be analyzed for their intensity and local extension to observe possible föhn border effects related to residual haze.

During stable inversion periods turbulence and convection are the determining parameters for vertical and horizontal mixing and transport phenomena. Both effects and their evolution with time can be continuously registered by Sodar measurements. The addition of a Doppler display to the Sodar and simultaneous control of fluctuations of ground level air masses will provide a numerical description of these phenomena.

Further measurements and experiments will deal with the following subjects:

- Diffusion and transport studies on the area according to the different classified atmospheric conditions by multitracers ( $\text{SF}_6$ ,  $\text{SO}_2$ , spray propellant freon clouds) experiments monitored by the appropriate analytical techniques, comprising, as far as possible, remote sensing techniques;
- Analysis of the distribution of the inversion layers by remote sensing techniques (Sodar, Lidar) and aloft sampling (aerosol);
- Statistical interpretation of the data and use of these data to develop interpretative models able to describe the dispersion phenomena of the area under study.

### 1.1.2.4 Laboratory Experiments

Emphasis will be on the study of photo-chemical and gas-gas reactions, which produce haze particles under simulated atmospheric conditions. These reactions will be carried out in high volume plas-

tic bags of Tedlar (polyvinylfluoride) using sunlight or artificial light with similar characteristics for irradiation. The formed aerosol will be analyzed for particle number concentration and size distribution. Reaction products will be determined using the "multidetector unit" and possibly long-path infrared absorption.

Kinetic studies will serve to determine the rate of formation of particles and possibly the reaction mechanism. The influence of trace gases like nitrogen dioxide ( $\text{NO}_2$ ) and ozone ( $\text{O}_3$ ) will be continuously checked during the experiments. Before indications from field measurements are available, the existing theories for haze particles formation will serve as a basis for selecting the reactants.

To start with, compounds found in relatively representative concentrations in the atmosphere will be tested for their particle forming potential. Pinene, isoprene, etc. will be used, together with varying concentrations of  $\text{NO}_2$  for photochemical reactions and with ozone for gas-gas reactions.

### 1.1.3 Related Studies

#### 1.1.3.1 Uptake of $\text{SO}_2$ by plants and soil

The background of the  $\text{SO}_2$  in the atmosphere is influenced by its dispersion and by its physico-chemical evolution such as chemical conversion, adsorption and absorption which ultimately will remove it from the atmosphere. Studies on most of these topics are carried out in a number of European countries and scientific exchanges and collaboration on this broad subject are fostered by the Committee of the European Communities for Cooperation and Coordination of Scientific and Technical Research (COST) under the project entitled "Physico-Chemical Behaviour of  $\text{SO}_2$  in the Atmosphere".

The contribution of the JRC at Ispra to this project is in progress since 1973 by the Chemistry Group in cooperation with the Biology Group, Ispra, Directorate-General XII, and has two main objectives:

- determine the uptake of atmospheric  $\text{SO}_2$  by plants and soils as a contribution for the assessment of the half-life of that pollutant;
- establish the cycle of the  $\text{SO}_2$  in the system air-soil-plants-air.

Since the other parts of the larger COST project consider aspects related to chemical conversion and dispersion of the  $\text{SO}_2$  as well as to its ad- and absorption by water surfaces and building materials, the programme proposed and contributed by the JRC was

purposely restricted to studies of absorption of sulphur dioxide by plants and soils.

The orientation of the activity after 1977 will depend on the overall evolution of the COST Project 61 a) for which decisions will be taken during 1976.

The studies are carried out under controlled conditions so as to separate the various parameters with more accuracy. The experimental scheme consists in placing plants and/or soils in an environment of constant  $\text{SO}_2$  concentration at desired environmental conditions. Three main types of experiments are scheduled :

- the  $\text{SO}_2$  is in contact only with the aerial parts of plants growing in media of varying sulphur content and varying environmental conditions. In all cases the growth solution or soils are protected from  $\text{SO}_2$  contamination;
- the  $\text{SO}_2$  is in contact only with different soils varying in physical and chemical characteristics including microbial activity
- the  $\text{SO}_2$  is in contact with both the plants and the soils used as growth media.

Test plants will be annuals and perennials, mainly trees, chosen as representative species growing in Europe. Similarly, the soils considered will be representative of various types found in the European Community.

As the situation stands in January 1976, the studies scheduled should consider  $\text{SO}_2$  uptake by annual crop (beans) and a tree species (poplar) which has varieties growing in all countries of the European Community. It is expected that this study will be completed by June 1977.

An extension of the programme to include other tree species most represented in European forests or/and wind brakes, as well as pasture plants (clover and rye) is foreseen. A further extension may be envisaged to include :

- extra parameters of plant nutrition status,
- plant health status,
- combined effect of other atmospheric pollutants,
- combined effect of agricultural crop additives (insecticides, herbicides, etc...)
- studies under field conditions.

Upon completion of the soil studies envisaged it is proposed to expand determinations of  $\text{SO}_2$  to water surfaces.



### 1.1.3.2. Urban Air Quality Modelling

During the current programme a stochastic model (random walk) for the description of SO<sub>2</sub> dispersion in urban areas has been developed. It will be ready by the end of 1976. It is foreseen a follow up period of two years to implement the model in a city in order to demonstrate its practical applicability and to carry-out a parametric sensitivity analysis.

### 1.1.4. Planning

ENVIRONMENT AND RESOURCES				
Subproject : Particle formation and transport of pollutants				
PLANNING	1977	1978	1979	1980
Main Project				
SO <sub>2</sub> uptake by plants and soil				
Urban air modelling				

## 1.2. SUBPROJECT : ILE - PATHWAY OF AUTOMOTIVE LEAD

### 1.2.1. Background

Interest in the amounts, origin, and fate of certain elemental species such as lead, mercury, cadmium has quickened in recent years for their impact to public health and ecology even at trace levels. On a global scale, the pollution aerosol transports lead and other metals generated anthropogenically as far as the polar regions.

Even to-day there still exists differences of opinion on the importance of the different sources of lead pollution, especially as regards motor-car exhaust. Therefore the interest in correlating the various sources of lead to environmental pollution is evident. Of extreme interest, furthermore, is an estimate of the amount of lead exhausted by vehicles and absorbed by the human body.

The method of choice is using lead of known isotopic composition in gasoline and to analyse the environmental samples by mass spectrometry. It is successful when the following prerequisites are fulfilled :

- the isotopic Pb ratio of the source must remain constant in time;
- it must be sufficiently different from the "background"
- it must be sufficiently different from that of other samples.

### 1.2.2. Technical description

In order to be able to differentiate automotive lead from other lead sources the decision has been made to control the production of alkyl lead, for use as additive to most gasoline in Italy (100 % in the two experimental regions) in such a way that only lead from the Broken Hill Mine in Australia with an isotopic composition ( $206/207=1.04$ ), significantly different from the lead normally present in the environment in Italy ( $206/207 = 1.18$ ) will be used.

Italy is particularly suitable for this large scale experiment for the following reasons :

- its refining capacity exceeds its consumption and therefore it exports part of the petrol produced
- a high percentage of the alkyl lead used as an additive is produced by only one company (SIAC)
- the importation of lead, no matter how used, is subject to government authorization; it is, therefore, possible to control the isotopic composition of all the lead imported;
- there is a high traffic intensity.

A preliminary investigation showed that Piedmont (especially Turin and province) offers interesting prospects for the work. In Turin, for some time now, an efficient network for the monitoring of atmospheric pollution (including lead) (Fiat centres) has been in operation since 1972.

The local meteorological situation is characterized by periods of inversion with little or no air movements. Furthermore a collaboration with various research Institutes has been instituted.

Sardinia (Cagliari and province) was chosen as comparison region for the following reasons :

- the region is completely isolated
- Cagliari city has high traffic intensity and a low industrialisation level
- possibility of interaction of lead aerosol with marine atmosphere and lead accumulation in sea sediments
- large number of inhabitants have Mediterranean anemia.

#### 1.2.2.1. Atmospheric lead

To evaluate the impact of automotive lead on atmospheric pollution, measurement of atmospheric lead concentration, particle size distribution, chemical composition are necessary. The following experiments are under way or planned :

a) evaluation of lead isotopic composition and air concentration in :

- urban areas with different intensity of traffic. Variations of lead concentration along streets (canyon effect); outdoor and indoor lead levels at different heights from the ground, will be considered
- selected rural areas will be studied as well as remote ones, such as mountains (Plateau Rosa)

b) vertical profile of airborne lead

- preliminary determination of lead isotopic composition and concentration in the lowest troposphere will provide information on the vertical transport during night and day. The observations are to be related to the particular atmospheric conditions and to the orography. There are towers 120 -145 meters high in Turin, Trino Vercellese and Ispra
- on the basis of the preliminary results, determinations at higher altitude (up to 2000 -3000 meters) above the city of Turin could be performed. The use of a dirigible is envisaged.

c) chemical composition and size distribution

The chemical composition of the atmospheric aerosol together with its particle size distribution play a key role in determining air pollution effects. The health hazard associated with airborne particles depends on the site of deposition in the lungs which is related to particle size, shape and density; the efficiency of uptake of atmospheric lead by man will be high for particles having a diameter  $< 0.25 \mu$ .

The range of atmospheric transport depends on the particle size; their range determines the number of available environmental pathways.

The reactivity and solubility of inorganic compounds is correlated to the chemical form. Therefore it is planned to characterize the composition of aerosols by identifying the different lead compounds.

The experiments at points a), b), c) will provide :

- a knowledge of the average atmospheric lead concentration in a urban area, to be considered representative for the quantity inhaled by the population;
- a set of data useful for a model relative to the lead mass flows in a city;
- information concerning atmospheric lead transfer from the city to the surroundings and perhaps remote areas;
- identification of eventual differences, determined in field conditions, of the physical-chemical form between the automobile and industrial lead;
- a classification of areas with different lead characteristics could be tentatively done to assess in a more complete way the population exposure. It may turn out that the exposure to the atmospheric lead could be more depending on its physical-chemical characteristics than on its concentration.

#### 1.2.2.2. Transfer pathways

By total lead and isotopic measurements the contribution of automobile lead exhaust to products which are considered the principal responsables of the oral intake of lead by man will be estimated. Among those of importance are vegetables, drinking water and wines, and diary products.

#### 1.2.2.3. Contribution to absorption in man

The final aim of the investigations is the estimation of the contribution made by the traffic to the lead absorption by the human body. The studies made to correlate the lead content in the different compartments of the human body (blood, bones, etc...) with the various environmental lead levels, have shown disagreement in the evaluation on the relative importance of absorption by man from the different pollution sources (automobile, industries, natural lead in diet). On the contrary it was evident that certain groups of the population (children, women) have a different response to the exposure.

The ILE project has the advantage to be a real field experiment, run for a long period of time (it started in 1975 and will last at least two years) with an unlimited number of subjects.

We hope to achieve the following :

- an evaluation of the average lead level in human blood attributable to the car exhaust for population living in urban and rural areas
- the variation with age (including children) of the amount of the car exhaust lead in blood
- the form of the curve of the lead isotopic ratios variation in blood following a short term exposure
- the form of the curve of lead isotopic ratios variation in blood from the start of a long term continuous exposure and the curve of decrease following cessation of exposure

On a few volunteers, isotopic composition determination in excreted materials (urine, faeces, hair, teeth, etc...) will be performed if and where appropriate.

#### 1.2.2.4. Distribution in the Ecosystem

Independent estimates of lead accumulated through separate transport processes can provide the terms for a material balance carried out on automobile emitted lead in a particular region. Turin and its surroundings are particularly suitable for achieving this purpose. To the estimates, exposed in the chapter concerning the atmospheric pollution, the following have to be added :

- Dry deposition
- Total (wet plus dry) deposition
- Lead in run off water and sewage

#### 1.2.2.5. Sampling Scheme

With a view to the complexity of the research, to the financial cost and to its interest for many countries a wide sampling scheme has been planned. In Piedmont two cities have been chosen : Turin and Asti. The former for its high traffic density (about 50 % of the whole region), the latter as the one with the lowest density (about 5 % of the whole region).

Villages with low traffic intensity and rural characteristics (Trine V., Lanze, Viù, Ispra, Frinco) and remote zones in mountain regions (Gressoney, Isollaz, Plateau Rosa) have also been considered.

Cagliari is the only city in Sardinia under study : villages in its surroundings (Suelli, Barumini, Senorbi, Selegas, Tuili, etc...) are the comparison rural areas.



### 1.2.5. Association with External Organizations

The following national organizations are collaborating :

- Snam Progetti - Milan
- FIAT - Turin
- Laboratorio Cosmogeofisica CNR - Turin
- Istituto di Igiene University - Turin
- SIAC - Milan
- Stazione Sperimentale per i Combustibili - Milan
- Laboratorio Ricerca Ambientale - Trino Vercellese

Those who are willing to collaborate are :

- Istituto Ciamician University - Bologna
- Texas University - Dallas (USA) : Dr. Manton
- Florida State University - Tallahassee (USA) : Prof. Winchester
- Louvain University (Belgique) : Dr. Desaedeleer
- Lund University (Sweden) : Dr. Akselsson

### 1.3. MANPOWER AND COSTS

PROGRAMME : ENVIRONMENT AND RESOURCES				
PROJECT 1 : ATMOSPHERE				
	1977	1978	1979	1980
RESEARCH STAFF	39	39	36	36
INVESTMENTS (K.U.A.)	200	150	90	60
RUNNING COSTS (K.U.A.)	120	120	110	100
CONTRACTS (K.U.A.)	50	50	50	30

## 2. PROJECT: WATER

### 2.1 SUBPROJECT: EUTROPHICATION

#### 2.1.1 Background

The problem of cultural eutrophication is very widespread and shows features giving rise to particular concern in the more industrialized countries as those of the European Community, where the "per capite" demand for water and the population density are great. Appreciable eutrophication has been observed throughout most European and North American freshwaters.

Many Alpine lakes, shallow lakes, artificial lakes, Dutch and Belgian ponds, channels; the Baltic Sea are eutrophicated or threatened by eutrophication. It is noteworthy that the trophic conditions of a water body may amplify the effects of other types of pollution and, particularly, those of thermal pollution.

Today, we can evaluate the supply of nutrients into a lake, roughly estimate the increase of their concentrations in the water, and, consequently, predict some of their effects on the biota. This information has an undoubtedly pragmatic importance because on this basis counteraction (e.g. treatment of the effluents) can be undertaken. On the other hand, the experts agree that we need more information on the eutrophication processes. As a matter of fact, many aspects of the nutrient cycle are known almost uniquely in a qualitative way, particularly as regards mineralization of organic matter and inorganic nutrient release from sediments. In the same field of lake hydrodynamics, where the use of mathematical tools has become current, many problems are still incompletely treated, as for instance the time evolution of the water density distribution (stratification) and the turbulent dispersion through stratified media, which are of paramount importance for thoroughly understanding the eutrophication process. As a consequence the next progress in aquatic ecology will be improving the quantitative description of fundamental phenomena and the cooperation between physicists and mathematicians from one side and biologists and chemists from the other one.

During the past four years the JRC has intensively studied and described the trophic state of Lake Lugano (this lake was identified in 1972 as one of the eutrophicated lakes to be studied in the framework of the OECD eutrophication programme). Hence, the JRC-Ispra has acquired a considerable amount of experience in this field.

A mathematical model has been developed, which allows, though in a simplified schema, the analysis of the connections between prima-



ry production and nutrient concentration, as functions of organic matter input.

A limnological buoy installed in the bay of Agno measures and records automatically physical and chemical data at various depths at prescribed times, as well as meteorological parameters. It is an important tool in view of discovering and analyzing correlations as regards physical and physico-chemical phenomena.

Furthermore, remote sensing, largely developed at JRC during the last years, could constitute a complementary research tool, worthy of being applied also to water surfaces.

### 2.1.2 Technical Description

The studies foreseen for the next four years will be developed as both experimental research and theoretical (physical and mathematical) investigations at the same time. The research will cover the following three topics:

- a) **Biology:** primary productivity rate as function of nutrient concentration and light intensity (vertical primary production profiles); fate of organic matter in the system (kinetic rate of biodegradation of dead algae, sedimentation rate, ...); effect on eutrophication of temperature increase caused by waste heat.
- b) **Sedimentology:** physico-chemical study of release mechanisms of inorganic nutrients from sediments.
- c) **Hydrodynamics:** studies on the stratification and destratification processes; vertical transport due to turbulent dispersion; horizontal transport and exchange between different bays of the lake.

Furthermore the possibility of using remote sensing in the framework of eutrophication studies will be analyzed, trying to correlate multispectral imagery from the LANDSAT-II [and -III] satellites and aircraft with ground data (chlorophyll, "yellow matter" and suspended matter concentration for lakes of different trophic level, concerning all countries of the Community). The studies include experiments on the reflectance of suspensions of different species of algae with a large range of population.

The results of these studies will later be fed into a global model, constantly improved in order to collect new details and evaluate their influence on the lake trophic condition (in particular as a consequence of points a) and b), a model for dissolved oxygen will be established). At the same time the data recorded on the buoy will be treated for subsequent elaboration, interpretation and eventual verification of the model predictions.

## 2.2. SUB-PROJECT: EURASEP (INVESTIGATIONS ON SEA AND AIR POLLUTION IN SOME COASTS AND CITIES OF EUROPEAN COUNTRIES OF THE E.E.C.)

### 2.2.1. Background

The EURASEP project has been built around an announcement of opportunity in May 75 by the NASA asking for science support proposals for a NIMBUS-G satellite carrying advanced pollution monitoring sensors. Two sensors in particular were of interest for EURASEP: one concerns marine pollution. The other atmospheric pollution. This project was submitted to a NASA evaluation committee and finally accepted (official letter from the NASA Associate Administrator for Applications, December 2, 1975, sent to the principal investigator at the J.R.C.). This selection concerns only the part "Marine pollution, because the atmospheric sensor will probably not be mounted in the NIMBUS-G satellite. Nevertheless, as it would be technically very interesting to use such a sensor in Europe, e. g. by flying it on an aircraft, the corresponding part of the EURASEP project is also indicated in this annex. It refers to another chapter of the programme: "Emission et transport des polluants"

The initiative for a concerted action taken by the J.R.C. and the Environmental Research Division of the General Directorate Research, Science and Education in Brussels derives from the following scientific background:

- a) The J.R.C. has, during the current 1973-1976 programme developed a certain competence in remote sensing techniques within the AGRESTE project (agricultural investigations in Northern Italy, Southern France and Madagascar), using data from the LANDSAT-II satellite are performed reflectance studies, light transmission measurements through the atmosphere (for atmospheric corrections) water quality investigations, modelling studies for data interpretation; a special software for the processing of satellite recorded magnetic tapes has been developed, this software is being extended to an interactive one allowing a direct visualisation of thematic maps on an oscilloscope screen connected to the computer of the JRC.

During the current programme, the JRC has developed a Raman LIDAR and a tunable diode laser for remote detection of atmospheric pollutants. These experiments have been completed by studies of the atmospheric layers with acoustic sounders, atmospheric pollution measurements, radioactive tracer experiments and atmospheric modelling studies.

Eutrophication measurements are done in Northern Italy lakes, their results are interpreted using JRC built water models. Full use of this competence obtained in various programmes can now be done concentrating it in a unique more ambitious project.

- b) At the beginning of the 4 years direct environmental programme, the Advisory Committee recommended to postpone activities using aircrafts and satellites until a better assessment of the possibilities of remote sensing

techniques could be made. The extremely fast rising availability of observation satellites [LANDSAT-I 1972, LANDSAT-II 1973, NOAA-3, Explorer A 1977, LANDSAT-III 1977, NIMBUS-G 1978, EOS-A and B, 1979, Seasat 1978, all belonging to NASA) and European or national projects (Meteosat, Sarsat (ESA), Cameleon (France)] obliges to day to reconsider seriously if it is now time to prepare their correct utilization. John Apel presenting the SEASAT project to the American Congress precised that this satellite would collect in one day the same amount of data as 20 000 ships. The analysis done by the JRC and the Services of the Commission in Brussels shows that any further delay of an European effort is undesirable. Together with other projects of European significance like the TELLUS project (with the EXPLORER A Satellite), the EURASEP project tries to create an European cooperative pattern for the utilization of satellite selected data, and an effective and efficient participation to advanced US experiments.

- c) Remote sensing with aircrafts and satellites has obviously an international aspect due to the possibility of covering large areas. But the dimension of the test-sites implies that many national laboratories participate to a project, in order to collect ground or sea truth data in the right conditions to bring together complementary skills and to develop joint methodologies allowing comparative results.

Finally, it seems desirable that the JRC should dedicate a part of its "Environment" effort to the contribution to the preoccupating marine pollution problems.

In fact, during the last years beyond the efforts devoted to the solution of fresh water pollution problems, substantive progress has been also made at the Community level in the field of marine pollution. By decision of the Council of Ministers (March 3rd, 1975), the EEC has signed the Paris Convention for the prevention of the marine pollution of telluric origin. Moreover, by its decision of December 8th, 1975, the Commission is hereby authorized to participate, within the Communities' sphere of competence, in the negotiations at the intergovernmental meeting in Barcelona, with a view to the possible conclusion by the Community of an outline Convention and protocols for the protection of the Mediterranean against marine pollution.

This Conference has adopted:

- A framework Convention for the protection of the Mediterranean Sea against pollution;
- A protocol concerning cooperation in combatting pollution of the Mediterranean Sea by oil and other harmful substances in cases of emergency;

- A protocol for the prevention of pollution of the Mediterranean Sea by dumping from ships and aircraft;
- Two resolutions concerning the establishment, objectives and functions of a Regional Center in Malta.

The Convention is open to the signature and accession of the EEC.

Under the auspices of UNEP an Action Plan for the Mediterranean Sea has also been agreed upon.

The EEC follows closely the evolution of this Action Plan. This Action Plan contains two main chapters: "Coordinated Mediterranean Pollution Monitoring and Research" and "Integrated Planning of Development and Management of Natural Resources".

Immediate steps are now being taken to implement the decisions contained in this Action Plan.

- Coordinated Mediterranean Pollution Monitoring and Research Programme

The research and monitoring component of the Action Plan called for the organization of the following seven pilot projects:

- . baseline studies and monitoring of oil and petroleum hydrocarbons in marine waters;
- . baseline studies and monitoring of metals, particularly mercury, in marine organisms;
- . baseline studies and monitoring of DDT, PCB's and other chlorinated hydrocarbons in marine organisms;
- . effects of pollutants on marine organisms and their populations;
- . effects of pollutants on marine communities and ecosystems;
- . coastal transport of pollution;
- . coastal water quality control.

In consultation with the specialized agencies concerned (FAO, IOC, WHO, WMO) seven national research centres were selected as potential regional activity centres for the seven pilot projects. The selection was based on their technical competence with due regard for their appropriate geographical distribution and planned development.

A joint IOC/WMO/UNEP Expert Consultation was held in Malta (8-13 September 1975) attended by 36 participants from 12 Mediterranean countries. The meeting developed the operational docu-

ments for two pilot projects: one on basic studies and monitoring of oil in marine waters and the other on problems related to physical transport of pollutants.

- Integrated Planning

Under the Integrated Planning of Development and Management of Natural Resources chapter of the Mediterranean Action Plan, the Governments of the region declared themselves ready to make a joint and thorough study of any proposal aimed at reconciling demands of development with the need to protect and improve the quality of the Mediterranean environment, with a view to the optimal utilization of its resources. Furthermore, the Governments considered that it would be appropriate to develop programmes of activities or to amplify those which are already implemented in fields such as:

- . treatment, use and safe disposal of organic and industrial waste;
- . restoral of degraded natural communities;
- . best use and recycling of fresh water;
- . improvement, and better utilization of the living resources of the sea;
- . the study of the cost and of the economic and social advantages of taking the environment factor into consideration in development projects;
- . the study of the repercussions of economic development, particularly of tourism and industry, on the environment of the region;
- . the study of a system of vocational training at all levels;
- . training and technical assistance activities;
- . the organization of meetings of national experts in order to guide the development of the various parts of the programme indicated above;
- . to provide assistance for national institutions of the region in programming and implementing the projects adopted, or to help them obtain such assistance.

Moreover, the first phase of a "Blue Plan" is in an advanced stage. This project covers almost all the activities falling under the Integrated Planning chapter of the Mediterranean Action Plan. The "Blue Plan for Actions in the Mediterranean Region" would include studies in such areas as population and socio-cultural questions, food and agriculture, human settlements, industry, trade, transport and tourism. Long-term trends in each of these fields will be iden-

tified and their effects on the environment analyzed. In the light of this analysis, and where necessary alternative socio-economic development policies will be elaborated. The final objective of the project is to put at the disposal of national decision-makers and development planners, instruments that would allow them to formulate plans for optimal socio-economic development on a sustainable basis without environmental degradation.

The Committee for Scientific and Technical Research (CREST) created in 1974 a study group "R&D on Oceanology". The interim report (ref. XII/718/74 E European Communities) of June 17th, 1974 "Monitoring of Marine Pollution" suggests concrete R&D actions which would be carried out by the Community. One of these actions is "Development of a Community wide system of detection of oil slicks from ships or from off-shore drilling, by remote sensing from aircraft and real time transmission to ground stations for sampling to identify sources". Proposed ways of implementation: concerted or common action.

Although the EURASEP project is not focused on the oil slicks detection and does not consider at present real time transmission, it fits fairly well with the CREST recommendations. If it were necessary to experiment real time transmission, it would be easy to extend the EURASEP project along this line.

The EURASEP project would in any case provide the Commission, and through it to the Paris and the Mediterranean Convention, a comparative evaluation tool in different coastal configurations.

It must be noted that eight of the nine EEC countries have a sea shore covering some thousands of kilometers. The present proposal would, for the JRC, consist in transferring a part of its activity with regard to lake water, to an activity contributing to the monitoring of sea pollution.

## 2.2.2 Technical Description

### 2.2.2.1 Marine Pollution

#### a) Objectives:

- Space-time distribution of pollutants : quantitative determination of chlorophyll-alpha concentration, quantitative determination of gelbstoffe concentration, quantitative determination of sediment gradients, detection of oil slicks due to accidental and operational discharges from vessels and to untreated urban and industrial discharges in estuaries.

- Measurements of coastal water temperatures: influence of urban and industrial effects on the natural temperature variation (day and night, sea-currents).
- Establishment of models describing the effect of tide currents, coastal currents, general sea currents in open or closed sea on the transport of sediments.
- Establishment of models describing the effect of tide currents, coastal currents, general sea currents on the dispersion of waste heat coming from estuaries.
- Establishment of models describing the propagation of oil slicks (fractioning, spreading out<sup>(\*)</sup>, drift resulting from surface winds).

b) Interest of quantitative determinations:

- Quantitative determination of chlorophyll-A gives important information on the various states of phyto-plankton activity and primary production. The dynamic evolution during the season cycle and its geographic variation give other information related to the degradation of sea fertility in polluted zones.
- Quantitative determination of suspended matter (sediments and gelbstoffe) or turbidity gives important information on the penetration of light into water and consequently on photosynthetic activity at different depths. This turbidity is due to sediments coming from the coast or from rivers, or to the agitation of the sea bottom by currents. Convenient models will allow appropriate counter measures for the reduction of industrial or urban discharges or a better prediction in planned new coastal industrial areas.
- The measurement of surface temperatures allows the preparation of gradient maps. These maps will be useful for the biologists interested in the evaluation of the consequences of thermal pollution on living marine organisms.

c) Remote sensors and platforms

C.1. - Data obtained from NASA and collected by the NIMBUS-G satellite

The NIMBUS-G satellite scheduled to be flown in 1978, will carry a complement of eight sensors devoted to investigations in the areas of pollution monitoring, oceanographic observations and meteorological observations. Many of the sensors to be flown are of advanced design and complexity.

Among these sensors, the coastal zone color scanner (CZCS) is a scanning radiometer which will measure colour and temperature of the coastal zones of the oceans with a resolution of 800 x 800 meters, or less. The spectral bands measuring reflected solar energy are located at the following wavelengths.

---

(\*) Verification of existing theories of FAY and BLOKKER

- (1) 443  $\pm$  10 nm
- (2) 520  $\pm$  10 nm
- (3) 550  $\pm$  10 nm
- (4) 670  $\pm$  10 nm
- (5) 750  $\pm$  50 nm

The spectral band for measuring emitted terrestrial energy (and, hence, surface temperature) is located in the following region

- (6) 10,5 - 12,5  $\mu\text{m}$

Investigation: Determination of chlorophyll, sediment and gelbstoffe (yellow substance) concentrations and gradients in coastal waters- observations of coastal water temperature and thermal gradient night and day.

Another sensor, a temperature humidity infrared radiometer (THIR) will be flown primarily to provide correlative imagery for the other sensors. THIR is a 2-channel scanning radiometer (6,5 - 7,0  $\mu\text{m}$  with 21 mrad. f.o.v. giving water vapor absorption, and 10,5 - 12,5  $\mu\text{m}$  with 7 mrad f.o.v. corresponding to the atmospheric window).

NIMBUS-G will have a sun-synchronous high-noon circular orbit at an orbital altitude of 925 km. According to the payload assumptions (total weight 1090 kg), the data storage capacity is  $10^9$  bits and the maximum sensor data rate is 800 kb/s

The Commission sent so far to NASA a preliminary proposal to be substituted soon by a more complete proposal after the definition of a joint or concerned action. After review of the proposals, NASA constituted a NIMBUS G working team (NET), the JRC being selected for participation in this team.

c.2. - Data obtained from LANDSAT-II and LANDSAT-III satellites

LANDSAT-II was launched on the 22nd of January 1975. Its expected life is of 3 to 4 years. LANDSAT-II is equipped with a multispectral scanner (MSS) of 4 channels in the visible and near I.R. (0,4 to 1,1  $\mu\text{m}$  The ground resolution is 80 m.

LANDSAT-III is scheduled to be flown in late 1977. In addition to the M.S.S. identical to LANDSAT-III, a thermal I.R. channel will provide temperature maps, and a return beam vidicon (R.B.V.) will give a ground resolution of 40 m.

Data from these satellites can be obtained via the receiving station at Fucino (Italy), operational at the end of 1975.

c.3. - Data obtained from M.S.S. and radiometers installed on aircrafts and helicopters



Several aircrafts in the E.E.C. countries are equipped for multi-spectral observations in the visible, near I.R., and thermal I.R. (Daedalus, Bendix, Super Cyclope scanners).

In addition, radiometers can be flown on helicopters, either for direct observations, either for correlating aircraft or satellite data with lower altitudes measurements.

NASA seems ready to rent to European partners, within the frame of EURASEP a special multiscanner allowing for the simulator, at airplane altitude, of the NIMBUS-G scanner.

- Data obtained from other satellites

This possibility is under investigation.

- Repetitivity of the measurements, ground resolution, spectral resolution

According to a CNES report, the thermal I.R. resolution in European conditions should be 1 km, and possibly 100 m near the coasts. For chlorophyll-A, the same resolution should be necessary.

The spectral bands should be chosen narrow, in order to obtain a good spectral discrimination of the sediments. For chlorophyll-A, the accuracy of determinations should reach 0,1 mg/ m<sup>3</sup> of water in the range 0,1 to 1 mg/ m<sup>3</sup>.

The combination of sensors of satellites of different resolutions and accuracies with aircraft sensors should allow to reach these performances. The complete definition of the EURASEP project still needs a detailed study of the sensor performances, and a detailed study of the repetitivity requirements in order to establish a precise aircraft utilization planning. In the present estimation, 10 flights are being requested

#### d) Test-sites

(See the attached map)

The various test-sites have been chosen in order to offer a rather complete range of conditions:

- for the sea-test-sites n. 1, 2, 3, 4, 5: tide, salinity, pH, currents, surface temperatures, winds, density of suspended matter, probability of oil slicks, presence of estuaries, nature of the coast (sandy, rocky beaches, shallow waters). The contrast between Mediterranean and Atlantic will also be very interesting for the test of dispersion theories in a wide range of conditions.

#### e) Statement of the work

Many national laboratories have announced their participation in the EURASEP project; however, before a complete definition of the concerted action can be made, it is difficult to attribute precise tasks to

the JRC and to each partner. Nevertheless, the following list is a tentative which could constitute a framework for the discussion on various contributions.

- Sea-truth measurements: coastal water collected samples, and ship collected samples with a frequency to be fixed, then biological, physical and chemical analysis of these samples:
  - (i) Meteorological observations (temperature, wind, hydro-metry, sea conditions)
  - (ii) Control of training samples - Simulations of coloured effluents (f.i. with rhodamine)
  - (iii) Data collecting platforms using in-situ turbidity ultrasonically cleaned sensors for continuous turbidity monitoring

(all partners)

- Data processing

The JRC would essentially prepare the methodology: computer enhancement techniques will be developed in order to adequately analyse stable contrasts and low ocean radiances, contrast stretching rationing, differentiating, smoothing, filtering. The operational data processing will be consecutively performed either at the JRC or on the corresponding test-sites by the national teams.

- Laboratory experiments and theoretical basic studies

Spectroscopic and radiometric calibrations with simulated

- effluents and reference samples (catalog of spectral signatures)
- Development of special methods for chemical and physical analysis
- Theoretical study of basic phenomena (like light propagation in turbid water). Much effort by all partners will have to be made in this field.

- Modelling studies (deterministic and stochastic models):

For these studies the JRC could provide much to the theoretical support while the local knowledge for each test-site and the special disciplinary competences will be brought by the national partners.

This chapter is very important and requires a very good coordination. Many specialists will be necessary in various disciplines like physics, marine biology, chemistry, oceanology meteorology, mathematics and statistics, etc...

## 2.2.2.2. Atmospheric pollution

a) While the EURASEP-project in Marine Pollution combines data collected by various sensors and platforms, the atmospheric pollution study is essentially based on the availability of a NIMBUS-G sensor. "Measurement of Air Pollution from satellites (MAPS)" which seemed to be a good opportunity to complete air pollution measurements performed at the JRC. The MAPS instrument is a 3-channel radiometer which will view the Earth at nadir with an instantaneous f.o.v. of approximately 7 degrees. The channels for the measurement of the several gases will operate in the I.R. region of the spectrum. The instrument will measure Earth emitted radiances at 4,7  $\mu\text{m}$ ; 8,0  $\mu\text{m}$  and 11,2  $\mu\text{m}$ . A sample of one of the gases to be measured will be contained in a cell in each of the I.R. radiometer channels. The detector will view the Earth alternately through the gas filled cell and through an evacuated cell. The I.R. channels will be balanced periodically. The detectors will be room temperature pyroelectric devices at the longer wavelengths and thermoelectrically cooled (220°K) lead selenide at the shorter wavelengths.

Investigations: The instrument will map global distributions of CO, CH<sub>4</sub> and NH<sub>3</sub> in the troposphere. be measured in the following:

CO	:	4,7 $\mu\text{m}$
CH <sub>4</sub>	:	8,0 $\mu\text{m}$
NH <sub>3</sub>	:	11,2 $\mu\text{m}$

The measured radiances at these various wavelengths will be interpreted in terms of the total burden of the various constituents. The total burden of these gases will be measured with an accuracy of approximately 20 %.

## b) Objective: vertical profile monitoring

The EURASEP proposal initially consisted in establishing a programme for collecting corroborative data over selected truth-sites. Following informal NASA informations now it seems that this sensor has been taken off from NIMBUS-G. It would be installed in an aircraft flying in Sweden. Due to the strong scientific interest in such a sensor, the JRC interest was communicated to NASA, in case that any experiment could be made over Europe. The proposal derives from a suggestion of HINKLEY and KINGSTON to perform remote heterodyne detection of gaseous pollutants with tunable lasers (vertical profile monitoring) at the Conference on sensing of environmental pollutants, Palo Alto, Nov. 1971, then recently again at the Symposium on remote sensing of air pollutants, Pittsburg, 1974.

In this technique, the sun serves as an incoherent source of wideband radiation, and a turnable laser is used as a local oscillator in the heterodyne configuration. Using the sun, or just plain radiation as the source, this technique is

essentially single-ended (monostatic), the optical alignment and laser power requirements are minimal. The idea is that a pollutant gas in the stratosphere will have lines which are quite narrow, since pressure-broadening is small, whereas in the lower troposphere they will be considerably broader. In principle, therefore, one could measure the resulting lineshape and deconvolve it to yield pollutant concentration of altitude. Although such an experiment has yet to be performed, simulation in the laboratory demonstrated its feasibility.

The main difficulty seems to lie in the need to find a sufficiently powerful diode and a convenient receiver. The interest of these measurements lies essentially in the interpretation of over-regional displacement of pollutant masses.

- c) Test-sites (provisional), will be changed in April 1976  
(See the attached map and the attached list)

The various test-sites have been chosen in order to offer a wide range of conditions:

- test-sites n. 5, 6, 7 cover different climates, winds, frequency of rain, geographic features, industry type, importance of the industrial town, population density.

Several partners indicated their interest in different test-sites. The definitive choice will take into account these interests.

- d) Statement of work

- Development of a heterodyne I.R. receiver (JRC and/or national partners)
- Laboratory simulations and development of data processing methods (deconvolution)/JRC
- Chemical air analysis by conventional methods (in all the test-sites)
- Ground truth necessary for the interpretation of MAPS data (in all the test-sites)
- Use of the heterodyne I.R. Receiver at the test-site n. 6 (JRC and/or national partners)
- Processing of MAPS data (JRC and national partners).

2.2.3. Planning

PLANNING	1977	1978	1979	1980
pre- launch-phase				
post-launch-phase				

2.2.4. Contracts

The EURASEP project would request a preliminary external study contract for the complete definition of the sequence of sea-truth measurements. This study could be performed during the year 1976.

Other contracts concern aircraft flights during the years 1977 and 1978 in order to collect preliminary data for the preparation of methodologies. Then aircraft flights will be incorporated into the sequence of measurements, after the launch of NIMBUS-G.

2.2.5. Connections with the "Environment Indirect Action"

The EURASEP project fits into the research on 1.8. "Marine pollution", described in the 2nd indirect action programme, including the following topics: development of methodology for monitoring sea water quality along the coasts and in the estuaries of the Community, including

- a) modelling of pollutant transport
- b) the use of remote sensing techniques and
- c) the technical development of a system for the surveillance of oil pollution.

2.2.6. Connection with external organizations

Preliminary consultations have taken place between the Commission and the European Space Agency (ESA) on coordination and jobs sharing in the field of satellite data acquisition, pre-processing, processing and dissemination.

2.2.7. Existing competences and previous experience in Europe

Due to need of an equipped aircraft, the previous European experience is limited.

In France, the CNEXO with a CNES M.S.S. (Super Cyclone) has performed some experiments in 1974 (simulations of oil slicks).

The results were very encouraging.

With LANDSAT-II, the FRALIT project investigates the coastal sedimentation of the French Atlantic Coast, but only for its erosion aspect.

In the Netherlands and in Germany, flights and experiments on water reflectance are being performed and other experiments are planned (Flugzeugmessprogram). In the U.K. an interesting study on the teledetection of pollution in the Thames estuary has been performed by the Department of Environment. This study uses LANDSAT-I imagery digitally interpreted by IBM/USA.

It would, of course, be very important that these competences be included into the EURASEP project.

Many institutes of the member countries have announced their interest to become co-investigators in the EURASEP and to make a detailed repartition of the tasks and a new definition of the test sites. With their contribution, a detailed project will be established during 1976.

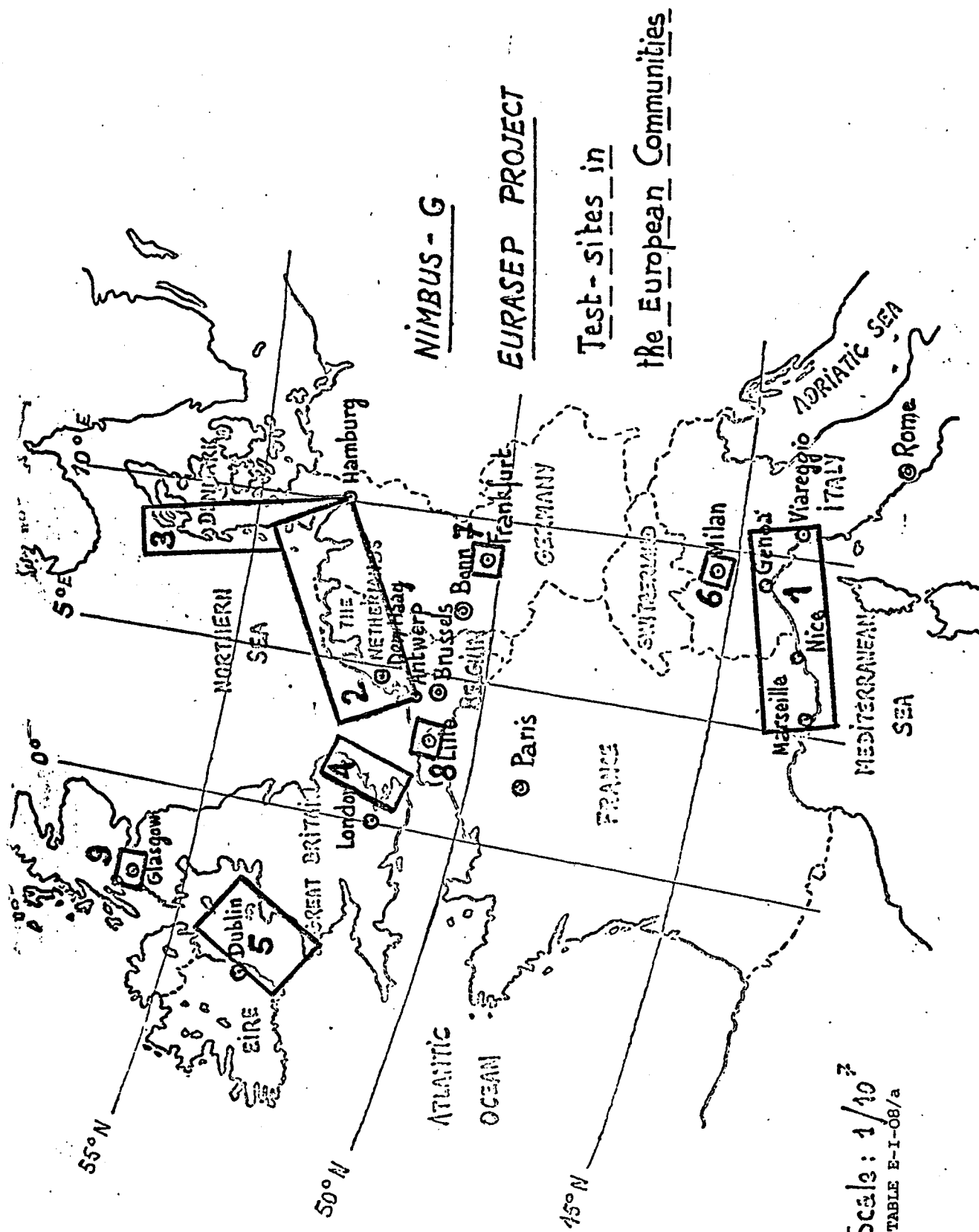

Scale: 1/10<sup>7</sup>  
 TABLE E-I-08/a

## 2.3 ECOLOGICAL EFFECTS OF CHEMICAL AND THERMAL POLLUTION IN WATER BODIES

### 2.3.1 Background

There are numerous "biological tests" ("bioassays") for water pollution, especially for chemicals. Review and assessment work for these indicator systems is in progress in various places in the Community, e. g. in France and at the Commission services in Luxemburg ("in situ" biological monitoring of water pollution). The JRC has developed in 1972-1976 two of such tests, namely one with fresh-water snails and one based on algae in continuous cultures. This work is now being concluded successfully.

Almost all these tests are based upon the mortality of a group of individuals. However, it is very difficult to extrapolate from these tests the damage to the population, because population is not simply the addition of certain numbers of individuals.

In conclusion the fundamental topic of the protection of the plant and animal species against pollution is to estimate if the damage produced by the pollutants in a population is equivalent (in terms of numerical reduction) to the effects of natural selection, exerted on the same population by the biotic and physical environment. If so, the population size remains constant. In case of a higher pollution level, the species is gradually eliminated. In between, there is the selection of "resistant strains".

This selection has been observed in several plants and animals as an effect of heavy pollution by pesticides.

To obtain "resistant strains", organisms with a short life-span and high reproductivity-rate (e. g. Rotifers, Cladocerans) must be used. Interpretation of the results may be difficult if this method is applied to Bacteriae and Protozoae for their high natural mutation rate.

The JRC has developed equipment to study the impact of chemical pollutants whose effects have been studied thoroughly. The interaction at population level between thermal pollution and chemical pollution and the accelerating effect on eutrophication processes due to thermal pollution has not yet been investigated.

### 2.3.2 Technical Description

It is proposed to put the emphasis of the study at population level on the interaction of thermal and chemical pollution. The influence



of the trophic level of the environment on the biological effects produced by chemical and thermal pollution will be studied in the project "Eutrophication". To do this, experiments in continuous flow systems on the interaction between temperature and low concentrations of heavy metals (Hg, Se, As and Cd) at population level of algae, crustacea, molluscs and fish will be carried out.

In addition to mortality, other demographic parameters will be taken into account, such as fertility, fecundity, age classes distribution and the intrinsic rate of natural increase (IRNI). The effects on algae will be checked by productivity and growth rate measurements.

In addition, some experiments in semi-natural conditions (a column of water, isolated from a natural body by means of plastic sheet) will be carried out in different seasons to evaluate the combined effects of temperature and heavy metals on trophic conditions of a micro-ecosystem. From the comparison between micro-ecosystems, connected as well as isolated from the lake bottom, the influence of the sediment could be evaluated.

The final form of this part of the programme will be defined in relation with the detailed content of the new programme of "Indirect Actions" of the European Community, decided in February 1976.

To study the influence of low concentration of Hg, Se, As and Cd on the primary productivity and growth rate of different algal species, turbidostats will be used, both with monospecific and mixed cultures.

### 2.3.3 Expected Results

- Relationship between concentration of pollutants and population recruitment, i. e. evaluation of the lowest concentration of a certain pollutant which can significantly reduce the probability of a population to survive.
- Selection of a strain, resistant to the chosen pollutants,
- Effects of the pollutants on the interspecific competition.

### 2.3.4 Planning

This activity will be pursued throughout the next programme period.

2.4 MANPOWER AND COSTS

PROGRAMME: ENVIRONMENT AND RESOURCES				
PROJECT 2 : WATER				
	1977	1978	1979	1980
RESEARCH STAFF	22	22	25	25
----- INVESTMENTS (KUA)	190	130	100	80
----- RUNNING COSTS (KUA)	60	80	80	70
----- CONTRACTS (KUA)	230	230	180	170

### 3. PROJECT : CHEMICALS

#### 3.1. SUBPROJECT: ECDIN (Environmental Chemicals Data and Information Network)

##### 3.1.1. Background

Environmental chemicals are substances which occur in the environment as a result of human activity and which may be present in quantities capable of harming man, other living beings and the environment. They include chemical elements as well as organic and inorganic compounds, intentionally or unintentionally released. The potentially harmful effects of these substances or their breakdown products may be acute or chronic, and may also occur by way of accumulation or synergism.

The world's total production of organic chemicals (i.e. fully synthetic products, excluding lubricating oils) amounted to 7 million tons in 1950, it increased to 63 million tons in 1970 and is estimated to reach 250 million tons in 1987. About one third of the chemicals manufactured is released into the environment. A certain quantity of any chemical which is not reclaimed or recycled, will, in many cases after chemical modification and biological degradation, finally end up somewhere in the environment and especially in the hydrosphere. Hence the total environmental charge by synthetic chemicals in 1975 certainly lies between 60 and 100 million tons.

The great majority of these anthropogenic environmental chemicals enter the ecosphere without registration before marketing and in general without sufficient toxicity testing. Some 20,000 to 30,000 chemicals are manufactured in quantities above 500 kg/year (drugs excepted); only some hundreds of which are submitted to registration procedures. In practice, regulation, registration and control of chemicals are, in most countries, limited to drugs, food additives, pesticides, and in some instances to ingredients of cosmetics. Again and again chemicals once regarded as harmless have proved to be dangerous for man and animals. The most spectacular case was that of the polychlorinated biphenyls (PCBs) which owe their detection in the environment to the fact that they interfered with the gas-chromatographic determination of DDT. Moreover, once the PCBs were detected in the environment, people concerned had no clear picture of where they came from. PCBs have been used as an additive to rubber, paints, plastics, adhesives, insecticides and printing ink, and as heat transfer and insulating fluids.

The exemplary value of the PCBs case lies in the fact that large quantities of a potentially hazardous compound were released into the environment without any public knowledge of its sources and effects. Which one will be next?

It is evident, therefore, that some device is needed to record data and information on chemicals which might have an adverse effect on the environment. The essential stimulation for the ECDIN project came originally from the SCOPE\* - recommendation to build up an "International Registry of Chemical Compounds".

In 1973 the Council of Ministers decided to include into the Environment Research Programme of the European Communities a pilot project on a data bank on environmental chemicals. The project will constitute a valuable information source for the Environmental Management Information Network (EMIN) as foreseen in the framework of the EC programme of actions. This is to be an instrument which would enable all people engaged in environmental management and research to obtain rapidly reliable information on chemical products of environmental significance. ECDIN is a joint project of the JRC and indirect action in close collaboration with competent Institutions of the Member Countries. Construction and maintenance of the files and operation of the pilot project are under the responsibility of the JRC. Indirect action contributes by means of contracts with national institutes for data collection and for system development.

The basic principle of ECDIN is to store relevant information on a chemical product in sizeable quantities regardless of the form in which it is used, its intended function or its presumed "degree of harmlessness". It is difficult, at present, to define "sizeable", but an annual production figure of 500 kg has been defined as the limit above which a compound should be stored in the system. Moreover, all chemicals having a high toxicity although produced in lower quantities, and selected toxic natural products, for instance aflatoxins, will be included. It is estimated that eventually some 20.000 to 30.000 chemicals will be covered by the system. Criteria for the inclusion of mixtures, blends, preparations, etc, have been elaborated.

To allow an assessment of the environmental impact of an anthropogenic chemical it is deemed necessary to store data on production, properties, use pattern, disposal, persistence, dispersion tendency, conversion under biotic and abiotic conditions, biological consequences, and - as far as possible - structure-activity relationships.

Work is also starting at the United Nations Environment Programme (UNEP) to set up an International Register of Potentially Toxic Chemicals (IRPTC). Representatives of the Commission have taken part in meetings to set up this project.

\* SCOPE : Scientific Committee of Problems of Environment  
in the International Council of Scientific  
Unions (ICSU)

Plans exist in certain member states for the setting up of national data banks on environmental chemicals, e.g. DESCNET (UK) and DABAWAS (D). The OECD is also encouraging a cooperative effort to collect data on environmental chemicals and ECDIN is taking part in this project. Its scope is assessing data extraction difficulties and cost.

In the United States the National Library of Medicine is developing a toxicological data bank along similar lines as ECDIN and contacts with this project are fairly close. Other US agencies such as the National Cancer Institute, the Consumer Product Safety Commission, the National Institute for Occupational Safety and Health and the Environmental Protection Agency are developing data systems on environmental chemicals which are suited to their own needs. The JRC has contacts with all these organizations in view of cost-saving data exchange. In discussions at national, regional and international level the leading experts are overwhelmingly recognising the need to have information.

During the present phase ECDIN has, or will, answer many of the questions relating to what should be provided but some questions will remain unanswered and further experimental work needs to be undertaken. Current work is casting light on how ECDIN should develop during the next pluriannual programme of the JRC.

Much of the data relating to environmental chemicals is such that it is of value across the boundaries of individual states. Again, the collection of such data is an expensive operation and undertaking it at a Community level means that the task can be shared out and, at the same time, coordination can be effected. Dissemination of data to a larger user population also increases the usefulness of the data.

During the present pluriannual programme it has been demonstrated that the Commission would be in a good position to effectively coordinate the work of building up ECDIN, using the facilities of the JRC to develop a central nodal point in the network. Current work is showing that the funding of indirect actions in member states together with a central coordinating point at the JRC would be an efficient way of operating. Thus, the Centre is well placed to play an important role in the development of ECDIN.

A recent proposal for a new French law governing the production of all new chemicals has been notified to the Commission and this may have important implications for ECDIN. If implemented, such a law would require manufacturers to submit details of the proposed uses, levels of production, toxicity and other relevant data before authorization for the production of a new chemical would be given. It is reasonable to assume that data on similar existing compounds would be needed for comparison. Hence ECDIN could become a valuable

tool for the Community.

The JRC has been asked, in the framework of ECDIN, to give assistance to services of the Commission preparing directives on dangerous substances and water quality objectives. Moreover, existing files of chemicals in other services of the Commission will be incorporated into ECDIN (e. g. Customs Union files and trade statistics from the Statistical Office).

Furthermore, ECDIN is seen as a valuable part of the Environmental Management Information Network (EMIN) of the European Communities and could become one of the first systems at the JRC to be remotely assessed on-line, using the experimental European Informatics Networks (EIN) and EURONET.

Finally, ECDIN has a logical link to the multidetection unit being developed within the environment programme of the JRC, comprising a gas chromatograph, mass spectrometer, automatic data capture and mass spectra library retrieval system.

### 3.1.2. Technical Description

#### 3.1.2.1. Present work

ECDIN is now in a pilot phase collecting data on up to 5,000 chemical compounds. The project had earlier gone through a stage in which a large number of discussions were held to ascertain what might be the needs of potential users. In order to give people an idea of the possibilities, some test data\* were put into a computer retrieval system and used for demonstration purposes.

The main activities during the current phase of the project are:

- decisions on which data would be useful and hence would be included,
- collection of data for a maximum of 5,000 compounds,
- development of a "data format". For each element of data included, it is necessary to define what it is and how it should be written down,
- development and testing of a "format" for the exchange of data within ECDIN,
- input of data to the computer and adaption of the data to the computer retrieval system,

---

\* A file of some 1,500 chlorinated aromatic compounds with data on physical properties, manufactures, a few toxicity data and structure information generated by Prof. C. Levinthal of Columbia Univ., New York City.

- implementation of a suite of computer programs (CROSSBOW) which performs various operations on chemical structures e.g. generation of structure diagrams, substructure search.
- computer systems development, especially in relation to the manipulation of chemical structures for chemical structure /biological activity prediction and in environmental pathways prediction,
- preliminary work to form links between a computer-based mass spectra search, chemical substructure search and the chemical data systems,
- evaluation of the data collected so far in terms of its ability to satisfy the needs of potential users.

At present data is being collected for the 5,000 compounds and during 1976 it should be possible to consult users on whether the data are satisfactory. It will only then be possible to give reasonable estimates of the data connection costs.

The majority of the data has been collected under indirect action contracts.

### 3.1.2.2. Description of Future Work

#### a) General

A satisfactory continuation rate of ECDIN will of course depend on the resources available, i. e. manpower and money.

It will be possible as mentioned above, to give estimates of the costs of fully operating ECDIN when the needs of users have been assessed. However, in some particular fields, e.g. that of indicating the exposure of the population to a compound, the prediction is somewhat complex and it is desirable that a full-scale study be done to estimate the amount of effort required to collect data in this field.

#### b) The Future Structure of ECDIN

It is reasonable to consider two networks which can, if necessary, have very different structures. The first is the data-collection network and the second is the user service network.

The development of the data collection network will necessarily be ahead of the user service network. The important point for data collection is that the network should be well coordinated with competent

institutions doing the work. Whilst it is useful to consider a central point in each member country for answering queries (perhaps using all or the majority of the data), such a system for data collection might lead to an unacceptable level on administrative problems.

#### c) Data Collection

From 1977 onwards it is proposed that ECDIN enters another, more advanced and semi-operational pilot phase. The experimental data collection network will gradually evolve. It is considered that expertise at the JRC could evolve particularly in the areas of chemical data (names and formulations, etc.), production figures, chemical exposure data, use patterns and regulatory data, whilst institutions in the member countries might specialize in other fields (e.g. toxicity). In any case the JRC would coordinate the data collection and be responsible for the dissemination of data files to member countries.

The area of product formulations is, for example one in which a great deal of work needs to be done. It has been estimated that some 300,000 commercial products are marketed and while many of these are not directly relevant to ECDIN (e.g. pharmaceutical preparations), information about the formulation of other products would be a valuable addition to the data bank. It would be desirable to utilize existing data bases in this area because of the magnitude of the task of collecting these data but so far the only machine-readable files identified are concerned with the USA market. Some cooperation with European anti-poison centres could be envisaged.

The categories of data which would be the direct responsibility of the JRC and collection of these data would, in the main, be funded by contract or actually gathered at Ispra. Other categories could be the responsibilities of institutions in the member countries. It is considered important that this network be allowed to evolve on a flexible basis with competent institutions doing the work, rather than implementing a rigid, theoretical and possibly unworkable system.

#### d) The User Network

Some Services of the Commission are already asking to use the ECDIN data files. The data will obviously also be of interest to institutions in the member countries. It is premature to think of providing



an answer service to all users directly from the JRC and probably not feasible even in the medium term. It is proposed therefore that an experimental system be set up. It would be an experimental user service and based at Ispra. It would receive test queries from the Commission and from Institutions in the member countries. At the same time the file of data would be made available to any member state to set up an experimental service to its own users. For the first facility an experimental question answering service would need to be set up at the JRC. For the second, a data dissemination service would be needed.

An important feature of this experimental period would be the reaction of users to the answer they receive. A mechanism for feeding the results back to the JRC and facilities to modify ECDIN in the light of these results, would need to be set up.

During the next programme the possibility of setting up a central service using the computer communications networks (EURONET) now being developed will have to be considered.

#### e) Critical Evaluation of Data

An essential part of the data collection network would be in the critical evaluation of data. This could also be regarded as "user interaction with the data". In the process, data already generated would be subjected to examination. Conclusions would be drawn which themselves would go into the data files. A continuing feedback mechanism can be envisaged in which data are, from time to time, reassessed based on the new data that are brought into the bank or, on new criteria for basing judgments. Assessment of data by groups of experts would need to be set up on a formal basis. Interaction with Commission services is envisaged in this respect.

#### f) Computer Systems Developments

##### - Data Retrieval

During the next pluriannual programme, and based on the reactions of potential users to the present system during the current programme, the whole question of data retrieval systems will have to be examined. It is likely that a new on-line retrieval system would be needed but the possibility of the provision of different forms of outputs (e.g. microfilm) cannot be dismissed.

##### - Data handling

Data base management software would need to be introduced at an early stage. This software would be used to update the data files, facilitate

corrections to data and other file management tasks. This software could probably be based on one of the data base management systems currently available. The Information Management System (IMS) is already being used at the JRC for other work and could possibly be used for ECDIN.

Some of the above work could in principle be done at the JRC but it is probable that consultants would need to be called in to advise on the design aspects, and the software development could be contracted out. New hardware/software systems will need to be considered for the data input.

The high cost of data input makes it imperative that, wherever possible, use is made of existing data files. However, integration of data files into the ECDIN data bank is not achieved without effort. Not only must the programs for converting data formats be developed but the compounds in the file must be treated for identity with those already put into ECDIN. If unambiguous chemical identifiers as CAS numbers are not present there is a real and substantial cost in generating or obtaining them.

#### - Chemical Structure Retrieval and Display Systems

Two of the indirect actions in the Environment Programme are developing advanced software systems. The DARC system, being developed by Prof. Dubois in Paris, contains substructure search and display functions but is oriented to the examination of structure/function relationships. The CICLOPS system, being developed by Prof. Ugi in Munich, is essentially oriented to prediction of chemical reactions. It is envisaged that, if suitable, one or both of the systems will be implemented at the JRC. Implementation of CICLOPS will require the purchase of a minicomputer graphics display system, that is a PDP 11.45 system. Which programs are to be implemented will depend on the final results coming from these indirect actions. The CROSSBOW system, now in operation at the JRC will probably be substituted during the next programme period.

#### - Links Between the Chemical Data System, Substructure System and the Multidetector Unit

With CROSSBOW operating in batch mode it is already possible to display chemical structure diagrams for compounds "hit" during a mass spectral library search. The planned conversion of this search facility to the on-line mode of use will require development of links to the on-line display facility mentioned above. It is also planned to develop software

to utilize the structural fragment generation facility of CROSSBOW in connection with limited retrieval from the ECDIN data bank to provide methods for retrieving data on compounds similar to these found in environmental samples.

g) Systems Developments for Networking

The data "exchange format" being developed and tested by an indirect action contract would be used during the operation of the experimental "user network" to disseminate data to interested bodies. Machine-readable data bases, e.g. Toxis Substances List, would as a matter of course, be translated into this format and hence could be used more easily. Computer programmes to translate the ECDIN input format (used for convenience for data input) to the exchange format are being developed at present and it is envisaged that the transfer of data between the JRC storage and retrievals systems and the network via the exchange format would become normal practice. However, in order to achieve this a further set of programs would need to be written.

h) Chemical Structure Biological Activity Relationships

With the data, expertise and systems available with ECDIN it could be thought to set up later research projects with regard to specific problems of structure-activity relationship. Although the JRC would not play a central role in such projects, it is considered that this would be a valuable complementary research activity to ECDIN. This would be an appropriate subject for contracting out.

3.1.3. Planning

This activity shall remain constant during the next programme

### 3.2 SUBPROJECT: MOBILIZATION OF HEAVY METALS FROM FOSSIL-FUELED PLANTS AND ECOLOGICAL-BIOCHEMICAL IMPLICATIONS

#### 3.2.1 Background

The objectives of a new energy policy of the European Community (1) envisage important changes on fuel types for energy production, with greater emphasis on fossil fuel and nuclear energy than was previously anticipated (2).

For what concerns the environmental impact of fossil fueled power plants (FFPP) (3), coal-fired power plants (CFPP) are characterized by a much greater mobilization of heavy metals when compared to oil-fired power plants (OFPP) (3).

The perspective of a greater impact of CFPP in energy production emphasizes the necessity of a more accurate assessment on the importance which such plants may have in the additional mobilization to the environment of a few hazardous heavy metals which are already extensively mobilized by chemical pollution. Many of the mentioned elements, in fact, most easily pass through conventional particulate control devices of power plants (4).

CFPP will contribute mainly to the mobilization of Se, Hg, As, Sb, Cd and Pb whereas OFPP will mobilize especially V, Mo and Ni, due to the different concentrations of these metals in coals and in oil (3).

As coal contains generally 1-2 ppm of U (5, 6), the volatile and long-lived daughters of  $^{238}\text{U}$  ( $^{222}\text{Rn}$ ), the highly radiotoxic  $^{226}\text{Ra}$ ,  $^{210}\text{Pb}$  and  $^{210}\text{Po}$ , are found in the atmospheric discharge of CFPP with about the same enrichment factors as the stable Pb (7). On the other hand the uranium concentration of oil has been found to be about 20 times lower than that of coal (8).

The prediction of the integrated long-term effects of such releases appears rather difficult at present. The knowledge of the chemical and physico-chemical form of heavy metals emitted from power plants, which is very important in defining the air transport behaviour, is also rather limited. Moreover, the formation and behaviour of volatile compounds seems highly depending on the total elemental fuel composition. High emission rates for As and Se, for example, are typical of coals with a low calcium content (7).

In the light of the proposed focusing of the JRC activities on ener-

gy problems, a new orientation for the JRC environmental studies on heavy metals appears both feasible and motivated.

The objective of the proposed project is to investigate the role of fossil fueled power plants in mobilizing to the environment a few selective heavy metals (such as As, Cd, Mo, Ni, Hg, Pb, Sp, Se,  $^{226}\text{Ra}$ ,  $^{210}\text{Pb}$ ,  $^{210}\text{Po}$ ) in quantities large enough to interfere with the natural heavy metal cycle and to constitute a hazard for man.

### 3.2.2 Technical Description

The project has been organized into four actions:

#### 3.2.2.1 System Modeling and Definition of Methodologies and Research Priorities

This theoretical activity will provide the necessary framework for the experimental actions. A simple analytical model will be developed to describe the heavy metal flow in typical environmental systems of interest in power ecology. A sensitivity analysis of the model will provide an incentive for the experimental research activities.

Literature data will be collected and organized into input libraries for the model.

#### 3.2.2.2 Heavy Metal Emission from Fossil-Fueled Power Plants

It will be studied by laboratory simulation experiments and by in-plant and in-field measurements. The relative weight of the two types of studies will be decided during the programme (see planning).

Enrichment factors for heavy metals in fly-ashes with respect to crystal abundance and input coal composition will be determined. A particular attention will be dedicated to the physico-chemical nature of metals emission, which is important for defining the air transport behaviour of metals, for different plant operation parameters.

Air transport models will not be studied in this project. Information arising from the study "Air Transport of Pollutants" will be used to postulate typical input rates to the ecological transfer chains.

### 3.2.2.3. Ecological transfer studies

They will be mainly concentrated on the long term implications of heavy metals accumulation in typical environmental sinks, such as soils and sediments.

Typical studies in this research area are :

- influence of increasing concentration of heavy metals in soils with different pedological characteristics on the heavy metal uptake by plants.
- distribution of heavy metals into grass and vegetables, and consequences on the alimentary food chain.
- parameters of heavy metals uptake and release by sediments.

The limited personnel available will be concentrated into one or two actions, to be chosen on the basis of motivations arising from the modelling activity, also taking into account the work carried out within the frame of the indirect actions programme.

Long term effects on the agricultural-alimentary system will be evaluated taking advantage of the models developed in the frame of the programme "Technical evaluations in support of the Commission Activities".  
(See programme 10 -Project 10.5)

### 3.2.2.4. Metallobiochemistry and metabolic patterns of heavy metals

Studies already under way in the present programme will be continued for those elements which will be dealt with in the proposal project.

Two types of experiments are foreseen :

- a) Long-term - Low dose experiments (ILE)

A considerable effort was done during previous years to set up special radio-analytical techniques for biochemical studies on heavy metals at typical environmental concentrations. Low-term-low dose studies have already been done on cadmium and they will be applied to the other heavy metals.

Labelled heavy metals are administered via drinking water under controlled dietary conditions. Animals are periodically sacrificed and the organ, cellular and intra cellular distribution is obtained in order to identify critical organs of accumulation and specific metal binding components.

## b) Biochemical mechanisms involving heavy metals

After identification of critical organs and metal binding components from ILE, research will concentrate on parameters which affect the accumulation of metals in the body, such as influence of the metals on the synthesis of the metal binding component and synergistic or antagonistic effects of other pollutants.

Final characterization of the metal binding components such as elemental composition, stoichiometric ratios, saturation levels, identifications of binding sites will be carried out by in vitro studies. The interactions of metals with fundamental macromolecules already known as potential metal binding component, such as metalloenzymes and nucleic acids will also be considered.

3.2.3. Planning (see table E.I.08/b)

While action 3.2.2.4. (metallobiochemistry) is directly linked to the activity presently under way, a considerable reorientation of the experimental activity of the present studies on ecology metals is necessary.

For this reason, a considerable importance is given in the first part of the programme to theoretical modelling activities, which will provide the necessary motivation, frame and time plans for the experimental studies.

Two major decision points are foreseen towards the end of 1977 :

Decision point 1 : on the relative weight that simulation experiments and in-field measurements should have for the description of heavy metals emission and transport phenomena.

Decision point 2 : on the relative weight that terrestrial and aquatic transfer studies should have in the project. The manpower available, which is limited, will be concentrated on not more than two studies, also taking into account possible contributions arising from indirect actions dealing with related subjects.

project: MOBILIZATION OF HEAVY METALS FROM FOSSIL-FUELLED PLANTS AND ECOLOGICAL - BIOCHEMICAL IMPLICATIONS			
1976	1977	1978	1979
1980	PLANNING		
PRESENT PROGRAMME			
1. SYSTEM MODELLING no activity	<p>Theoretical modelling, assessment of research priorities, project organization.</p> <p>Development of simulation and analytical techniq.</p>	<p>Continuation of modelling activity, data collection</p> <p>Simulation laboratory experiments</p> <p>In plant and in field experiments</p>	<p>Final evaluation and conclusions</p>
2. EMISSION OF HEAVY METALS FROM POWER PLANTS Emission of lead from automotive exhaust		<p>Transfer of H.M. in terrestrial ecosystem</p> <p>Transfer of H.M. in aquatic ecosystem</p>	
3. ECOLOGICAL TRANSFER STUDIES Cd effects in rice cultures Cd effects in aquatic food chain			
4. METABOLIC PATTERNS OF HEAVY METALS Long term - low level exposure (LLE) on Cd	LLE: Pb and Se		
Preliminary experiments on Pb, Se and V.			LLE: continue as indicated by preliminary short term experiments and modelling system
Methodological improvements on cellular fractionation		As and Sb	Hg and Ni
PERSONNEL: A - university degree B - technicians C - operators	3 3 1	3 4 1	4 4 2
BUDGET (U.A.)	35.000	60.000	60.000
			50.000

decision points:  $\diamond 1$  SHOULD EMISSION PROBLEMS BE STUDIED PREFERABLY BY SIMULATION OR IN-PLANT STUDIES ?

$\diamond 2$  ASSESS RELATIVE IMPORTANCE OF TERRESTRIAL AND AQUATIC FOWER ECOLOGY.



### 3.2.4 Connections with External Organizations

Contracts with outside contractants have been envisaged to study areas where expertise is lacking within the JRC, such as microbiological aspects of soil and sediments chemistry. The estimated budget is 50,000 UA yearly.

### 3.2.5 References

- (1) "Vers une nouvelle stratégie de politique énergétique pour la Communauté", doc. COM (74) 550 final, 1974
- (2) "Perspectives de la demande d'énergie primaire dans la Communauté 1975-1985", doc. SEC (72) 3283, and doc. SEC (73) 128
- (3) K. K. Bertine, E. D. Goldberg, *Science* 173, 223 (1971)
- (4) D. F. S. Natush, J. R. Wallace, C. A. Evans Jr., *Science*, 183, 202 (1974)
- (5) J. N. Weaver, *Anal. Chem.*, 96, 1292 (1974)
- (6) R. A. Nadkarni, *Radiochem. Radioanal. Letters*, 21 (3-4), 161 (1975)
- (7) J. W. Kaakinen, R. M. Jorden, M. H. Lawasani, R. E. Wast, *Environmental Science and Technology*, 9, 9, 862 (1975)
- (8) I. G. Berzina, D. B. Popenko, Y. S. Shimelevich, *Geokhimica*, 8, 1024 (1969).

### 3.3 SUBPROJECT: FOLLOW-UP COST 64 b AND OZONE DEPLETION BY HALOCARBONS

#### 3.3.1 Follow-Up COST 64 b

##### 3.3.1.1 Background

The COST Project 64 b "Analysis of Micro-Pollutants in Water" came to an end on October 31st, 1975. The Commission's Services intend, in agreement with the Management Committee of Project 64 b, to propose to the Council of Ministers, a follow-up project. The JRC intends to continue its participation in this project, once it has been redefined.

##### 3.3.1.2 Definition of the Problem

Most ground and surface waters contain presently a great variety of organic compounds, the individual concentration of which is in general comparatively low. An inventory of compounds identified in various waters, prepared within the framework of the COST Project 64 b, includes more than one thousand different compounds (Document EUCO/MDU/40/74). It is assumed, that this is only a small fraction of the total. Part of these compounds are of natural origin, but most of them originate from human activities (industrial and municipal effluents, oil spills, washout from soil, rain-out from the atmosphere).

Many of these compounds are highly toxic to mammals (e. g. a number of carcinogenic compounds have been identified), and their harmful ecological effects can at present only be estimated.

It has been shown that part of these compounds are not, or only partially, removed during the processing of drinking water; there is evidence that some of them are converted to more toxic derivatives during chlorination or ozonization of drinking water.

Some persistent organic micropollutants (chlorinated compounds like polychlorobiphenyls) may accumulate in the food chain and can reach remarkably high concentrations in fish, birds and mammals.

In order to assess the real hazards presented by the organic micropollutants in water, analytical methods for their determination have to be developed. The low concentrations and the great variety of compounds in the samples present considerable problems for their

separation, detection and quantitative determination; at present, chromatographic methods, in combination with adequate detection devices, thus sophisticated and expensive equipment, offer the best possibilities to solve these problems.

The approach adopted within the framework of the COST Project 64 b was to consider in detail sampling and sample treatment, separation and detection, gas chromatography - mass spectrometry combination, reference data collection and data processing. Originally, the project included the concept of a simple multidetec-tion unit, but it soon became apparent that it would be more fruitful to pursue the development of multidetec-tion techniques able to cope with the maximum number of classes of micropollutants with the minimum number of analytical steps.

These methods will have to be, however, further developed and complemented by specific procedures for individual compounds, in particular for their quantitative determination, moreover, considerable work remains to be done in the computerized handling of data, which is, in view of the great variety of compounds, a necessity.

The methods for sampling and preliminary treatment of samples need further improvement.

The use of gas chromatographic separation techniques is limited to volatile compounds. Many of the organic water pollutants are too polar to be volatilized without extensive decomposition, and other methods have to be applied. Since a few years new possibilities are offered by high pressure liquid chromatography and a number of laboratories participating in the COST Project 64 b have already gained experience with it; this technique is in rapid development and efforts are indicated in order to broaden its applicability and to develop methods for routine use.

Furthermore, a comprehensive and regularly updated inventory of identified pollutants and of reference data seems to be necessary in order to allow an evaluation of the risk of water pollution for human health and for the environment.

Details concerning the content of COST Project 64 b and on the progress achieved, are given in the first and in the second annual report (Doc. EUCO/MDU/23/74 and EUCO/MDU/44/75).

### 3.3.1.3 Technical Description - Outline of the New Project

This outline is based on the recommendations of the Management Committee of COST Project 64 b given during the meeting of June

2nd and July 4th, 1975. The working group in charge of drawing up the new programme proposal should be asked to assign priorities to the different items and to elaborate them in detail.

As far as the overall subject is concerned, the multidetection techniques for the analysis of organic micropollutants in water, the new project should be an extension of COST Project 64 b without major modifications of the scope. In particular, it is not intended to extend the scope to the analysis of micropollutants in other media (air, food, etc.) within this framework.

In detail, the following items should be considered within the framework of the new programme (for practical reasons, the break-down follows the structure set up for Project 64 b):

- Sampling and sample treatment
- Development and improvement of methods for the quantitative extraction of organic compounds from water samples,
- Development of methods for the selective isolation of classes of organic pollutants from water samples,
- Development for methods for physical treatment of such samples (concentration procedures, prefractionation methods, etc.),
- Organization of interlaboratory comparison tests for such methods,
- Development of methods for chemical treatment of such samples, e. g. preparation of derivatives from certain substances in order to increase their volatility,
- Development of sampling methods for seston, sediments, aquatic organisms, etc., and of procedures for further treatment of these samples (extraction of pollutants, etc.),
- Evaluation of the stability of samples under defined storage conditions, etc.
- Gas Chromatographic Analysis
- Evaluation of the efficiency of different types of separation techniques as a function of substance classes to be analyzed,
- Evaluation of the performances of detection systems with emphasis on specific detectors,
- Organization of interlaboratory tests for the comparison of gas chromatographic equipment, including quantitative performance.
- Coupling of gas-chromatographs with mass spectrometers
- Evaluation of the performances of equipment (coupling devices,

- etc.), including output systems (multiple ion detection, mass-fragmentography, etc.),
- Organization of interlaboratory comparison tests for qualitative and quantitative analysis,
  - Optimization of resolution and sensitivity considering the substance classes to be analyzed.
  - Separation Methods other than Gas Chromatography
  - Further development of methods for the application of liquid chromatography in water analysis, in particular for the analysis of polar compounds, and the evaluation of available equipment,
  - Tests and evaluation of solid phases, solvent mixtures, etc., including interlaboratory comparison tests,
  - Use of liquid chromatography for sample prefractionation and purification before application to other separation techniques,
  - Development and improvement of detection devices, in particular of universally applicable detectors, and comparison of their performances,
  - Coupling of liquid chromatography equipment to mass spectrometers,
  - Other separation techniques which might prove suitable for water analysis.
  - Data Processing and Collection
  - Edition of hard copy mass spectra collections and chromatographic data sheets including references to other spectroscopic data, together with adequate indexing for manual retrieval,
  - Continuation of the build-up of the computerized spectrum library including necessary information on separation and detection characteristics; introduction of links to substance-oriented data banks (e. g. ECDIN),
  - Evaluation and, possibly, development of software for the retrieval of spectra and other information.
  - Collection and Editing of Data on Organic Micropollutants in Water
  - Continuation of the build-up of an inventory of identified water pollutants, possibly with the aid of computers; periodical edition of updated inventories,
  - Collection and publication of information on conversion and degradation pathways or organic water pollutants, and other relevant information.

### 3.3.1.4 Contributions of the JRC

a) Considering the experience and the results obtained by the JRC, particularly in the field of sampling, GC-MS analysis, (1) data handling and high pressure liquid chromatography, the following points taken from the "outline" of the follow-up of the COST Project 64 b will be tackled:

- Development and improvement of methods for the quantitative extraction of organic compounds from water samples,
- Development of sampling methods for seston, sediments, aquatic organisms, etc., and of procedures for further treatment of these samples (extraction of pollutants, etc.),
- Evaluation of the efficiency of different types of separation techniques as a function of substance classes to be analyzed,
- Evaluation of the performances of equipment (coupling devices, etc.), including output systems (multiple ion detection, mass-fragmentography, etc.),
- Further development of methods for the application of liquid chromatography in water analysis, in particular for the analysis of polar compounds, and the evaluation of available equipment,
- Use of liquid chromatography for sample prefractionation and purification before application to other separation techniques,
- Coupling of liquid chromatography equipment to mass-spectrometers,
- Continuation of the build-up of the computerized spectrum library including necessary information on separation and detection characteristics; introduction of links to substance-oriented data banks (e. g. ECDIN),
- Evaluation and, possibly, development of software for the retrieval of spectra and other information.

The JRC will also take part in interlaboratory tests and the data supply for an inventory of identified water pollutants.

b) Besides the contributions to the above mentioned specific points, we intend to follow the fate of the C<sub>6</sub> - C<sub>18</sub> petroleum hydrocarbons. This class of compounds recently turned out to have a widespread distribution resembling that of pesticides, a fact evidenced by different authors and with the "multidetecion unit" of the J.R.C.

---

(1) Gas Chromatography-Mass Spectrometry analysis.

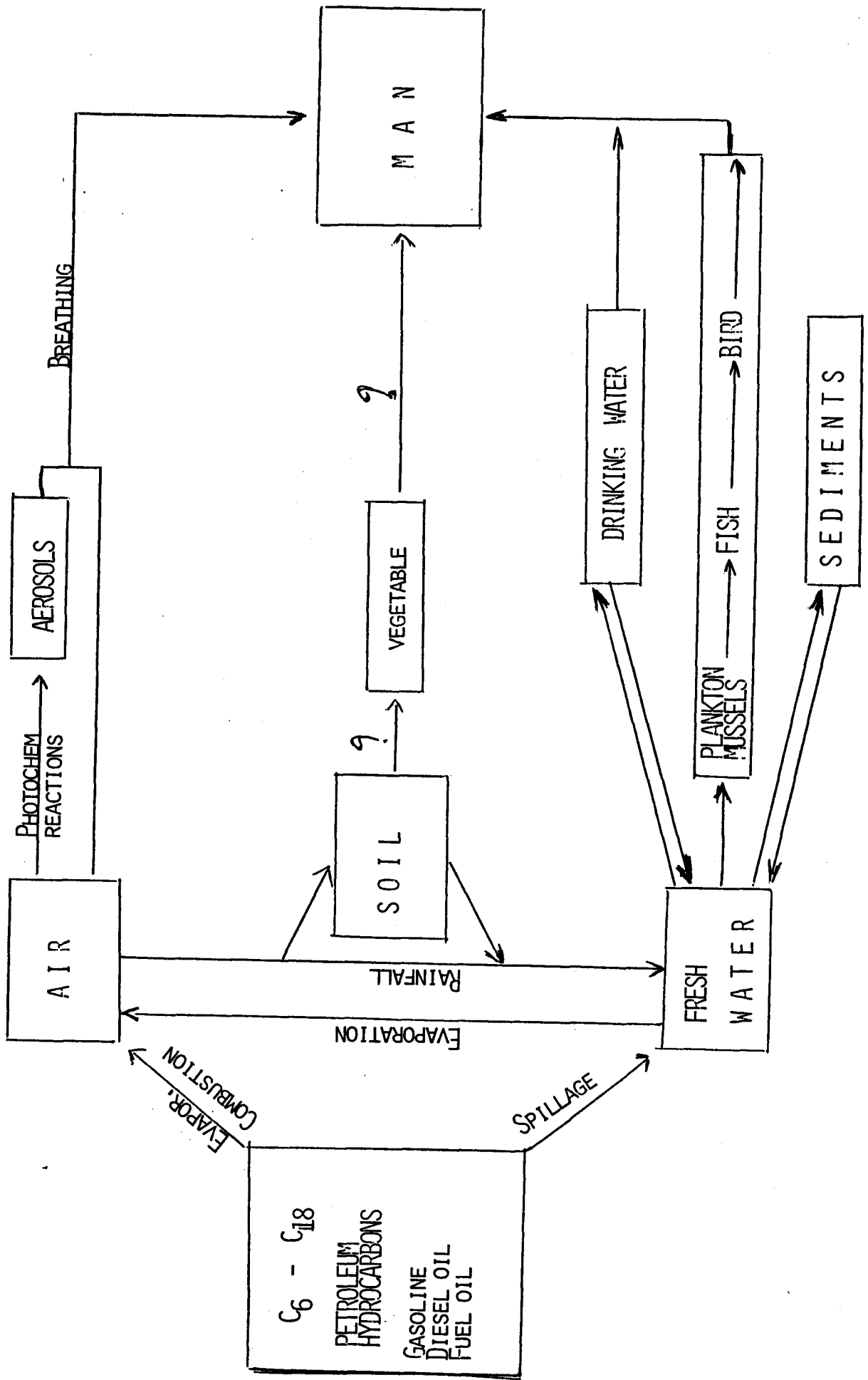

Their concentrations in urban, industrial and even rural areas is relatively high (ppb range).

There are also oxygenated derivatives but at much lower concentrations (ppt range), which are analytically hidden by the hydrocarbons.

Strong correlation exists among petroleum fuels, automobile and diesel exhaust and air pollution.

In almost all kinds of fresh water samples, this class of pollutants even forms the bulk of organic material, the other contaminants being solvents or industrial chemicals.

Moreover, the processing of waters to produce drinking water creates from these hydrocarbons new volatile organics: particularly the chlorination process may be a source of hazardous compounds, most of them being chlorinated ones.

Petroleum hydrocarbons have been detected in fresh water sediments and it has been demonstrated, that low solubility contaminants can easily evaporate from water to atmosphere and by rainfall turn back to water.

The relationship of hydrocarbon pollution in the different environments (air, water) and the pathway of these compounds in the ecosystems are far from being completely understood.

A study could follow the lines of the flow diagram of Table I.

The problems of interest are:

- Parallel analysis of air, rain and fresh waters (lake ground, spring) under different climatical and meteorological conditions in different areas (urban, rural, industrial) and their correlation;
- Analysis of aerosols from different areas (urban, rural, industrial);
- Fate of drinking water: analysis of water supply as such, after preliminary treatments (absorbtion), after chlorination; analysis of the final product and of the waste;
- Analysis of plankton, mussels (fresh water) and sediments to assess the pollution level and to control accumulation and release mechanisms;
- Analysis of blood plasma to verify contamination from drinking water;
- After results from the two previous items, possibly analysis of an aquatic food chain.



The parts of the first two items, having regard to airpollution, are already included in the "Atmosphere" Project ("Particle formation and transport of Pollutants"). The remainder of the first item as well as items 3 and 4 will be studied by the JRC as a further contribution to the COST 64 b follow-up project. The last two items will at present not be included in the JRC-programme.

### 3.3.2 Ozone Depletion by Halocarbons and Other Substances

#### 3.3.2.1 Background

Evidence of stratospheric pollution by chemicals capable of reducing the earth's ozone shield continues to accumulate. Oxides of nitrogen ( $\text{NO}_x$ ) from high altitude jet aircraft for example, are a potential hazard. Free chlorine is known to react with ozone. Sources of free chlorine in the stratosphere can primarily be chlorofluoromethanes, used as spray-can propellents and refrigerants, and also  $\text{CCl}_4$ ,  $\text{CH}_3\text{Cl}$  may contribute free chlorine to the stratosphere. Still under study is a catalytic agent which is potentially even more destructive of ozone than chlorine or  $\text{NO}_x$ , namely free bromine. The world production of  $\text{CCl}_3\text{F}$  plus  $\text{CCl}_2\text{F}_2$  in 1973 was 780,000 tons with a yearly increase of 10%.

The dimensions of the problem and the scope of the threat to living beings are far from being fully established. Not all the potential pollutants are clearly of human origin ( $\text{CH}_3\text{Cl}$ , for example). Predictions of the ozone destruction to be expected from a given concentration of pollutants are being revised downward on the basis of new laboratory measurements. But the laboratory studies and new high-altitude sampling have tented on the whole to support, if not completely confirm, the photochemical models on which calculations are based. And it is thus increasingly likely that the potential for release of chlorine and other species into the stratosphere will impose very real limits on human use of certain chemicals and technologies, limits that are global in extent and not far in the future.

It is likely that the US will ban the use of chlorofluoromethanes as propellents. European countries will not necessarily have the same attitude towards this problem. Therefore specific research is needed in Europe in order to assess the particular situation in this part of the world and to give scientific support to regulatory agencies.

### 3.3.2.2 Technical Description

The Commission's services are now establishing a working party of specialists in the field in order to prepare a joint research programme where the JRC intends to participate.

The topics of such a programme could be:

- a) European inventory of production, use and environmental release of halocarbons such as  $\text{CCl}_3\text{F}$  (Freon-11),  $\text{CCl}_2\text{F}_2$  (Freon-12),  $\text{CH}_3\text{-CCl}_3$  and  $\text{CCl}_4$  which have been measured easily in all locations and times (ubiquitous halocarbons).
- b) European measurements in urban, industrial and rural atmospheres of ubiquitous halocarbons in order to assess the European background.
- c) Analysis (identification), in different atmospheres, of all types of halocarbons in order to "describe" the entire spectrum of these compounds released into the atmosphere. This analysis should help to identify the possible hazard of compounds of minor concern to-day. E. g. special attention should be paid to those compounds which seem to be tropospheric (but not stratospherically) stable such as  $\text{CClF}_3$ ,  $\text{CCl}_2\text{F}$  -  $\text{CClF}_2$ ,  $\text{CClF}_2$  -  $\text{CClF}_2$  and for compounds containing bromine and not hydrogen such as  $\text{CBr}_2\text{F}_2$  and  $\text{CBrF}_2$  -  $\text{CBrF}_2$ .

A certain attention should be devoted to the fate of  $\text{CH}_3\text{Cl}$  which is both of anthropogenic and non-anthropogenic origin: though reactive in the troposphere, as all the halomethanes with a C-H bond, it could be a potential source of stratospheric chlorine.

Compounds such as  $\text{C}_2\text{Cl}_4$ ,  $\text{CHCl}_3$ ,  $\text{CHClF}_3$  and  $\text{CH}_2\text{CHCl}$ , which are tropospheric reactive, are of minor concern though the first two should lead to large quantities of toxic phosgene ( $\text{COCl}_2$ ) and the latter is a carcinogenic.

- d) Analysis of other non-halogenated stratospheric pollutants:
  - the primary source of stratospheric  $\text{NO}_x$  is the 2400 megatons of  $\text{N}_2\text{O}$  of natural origin in the atmosphere. Any increase by man's activities to the production rate of  $\text{N}_2\text{O}$  can be expected eventually to be transmitted into increased  $\text{NO}_x$  in the stratosphere. Any such effect would first be observable through an increase in the tropospheric  $\text{N}_2\text{O}$ .

- carbonyl sulphide ( $O = C = S$ ) is an inert molecule recently detected in the atmosphere. Its photolysis at about 25 km leads to the release of S atoms which form  $SO$ ,  $SO_2$  and then  $H_2SO_4$ . This will alter the natural aerosol layer at 20 km which scatters the incoming solar radiation.

- e) Tropospheric and stratospheric analysis and inventory of the compounds listed in a) and b) and eventually of some of the compounds emerging from c) and d).
- f) Ultraviolet photolysis of compounds under tropospheric stratospheric conditions. Special attention should be paid to the photolysis of the tropospheric stable compounds.
- g) Diffusion and transport of these compounds through atmosphere, troposphere to the stratosphere.

The exact share of the work for the JRC should, of course, be further discussed.

Nevertheless, considering that the JRC is well equipped on the analytical side and it has already acquired expertise in the atmospheric analysis of  $SF_6$  and halocarbons, its work could tentatively cover points b) and c) of the programme listed above.

### 3.3.3 Planning

	1977	1978	1979	1980
COST 64 b) Follow-Up				→
OZONE Depletion			→	→

### 3.4 MANPOWER AND COSTS

PROGRAMME: ENVIRONMENT AND RESOURCES				
PROJECT 3: CHEMICALS				
	1977	1978	1979	1980
RESEARCH STAFF	34	34	34	34
INVESTMENTS (KUA)	30	90	20	80
RUNNING COSTS (KUA)	110	140	150	140
CONTRACTS (KUA)	50	110	110	120

The credits required for contracts related to ECDIN constitute a minimum sum which takes into account the necessity to wait for the decision at the end of 1977 to pass from the pilot to the operational phase, and the existence, for the year 1977, of the indirect action credits planned to cover a certain number of additional contracts.

In due time, during the course of the programme, a review of the requirements should be carried out.

#### 4. PROJECT : AGRICULTURAL RESOURCES

##### 4.1. SUB-PROJECT : POST AGRESTE PROGRAMME

##### 4.1.1. Follow-on and conclusion of the "AGRESTE" Project

At the present time the "AGRESTE" (Agricultural Resources Investigations in Southern France and Northern Italy) Project is being executed in the frame of the objective 2.53.0 "Remote Sensing of Earth Resources". This programme is aimed to set up automatic classification and mapping for inventory of rice fields, poplar cultivations, conifer afforestations and beech forests, as well as for forecasting yield production and determination of timber volume carried on in collaboration with some specialized French, German and Italian Institutes. The programme is based on the utilization of data of NASA'S LANDSAT-2 satellite (launched in Jan. 1975) and of data gathered by means of aircraft and helicopters. Data examination is made in close correlation with "truth" measurements performed on ground. A certain number of "test-sites has been chosen in Northern Italy, in Southern France and in Madagascar's tableland; on the Commission's side, Directorates-General for Agriculture, for Aid to Development and for Science, Research and Education together with the Joint Research Centre participate in the Project. The "AGRESTE" Programme is the subject matter of a contract with NASA, awarded after a selection among several candidates.

The results gathered so far have been presented to some international Congresses, reported in several specialized magazines, JRC reports and have been communicated via ad hoc progress reports, to the Permanent Committee for Agronomic Research (P.C.A.R.) which meets regularly at the General Directorate for Agriculture in Brussels. The publication list is attached to this document.

In 1975, NASA has provided the AGRESTE staff with about forty satellite scenes covering the six European test-sites. This imagery was taken in the period March-October, while the imagery for the Madagascar test-sites will range from December 1975 till May 1976, owing to the shift in time existing between the local agricultural season and the European one.

By 1976 all the European Scenes will be analyzed, except for the last Madagascar scenes (May 1976). In fact a delay of about five months occurs before receiving imagery by co-investigators. This is due to the time needed by NASA for transforming a "image-scene" into a "magnetic tape-scene" to be processed by the JRC's 370/165 Digital Computer.

Moreover, the yield forecasting methodology investigated on the JRC's lysimeters in 1974 and 1975 and being experimented on field in 1975-1976 needs to be checked in 1977. In fact results of field investigation can only be known after the rice harvesting period (i.e. end November). Therefore a final evaluation can be assessed only during 1977.

Following the positive results gathered so far in the frame of the AGRESTE Project, the participating Institutes have informed the JRC that they want to continue the AGRESTE investigation and extend it out of the presently limited pilot zones to more extended agricultural ones. During 1977, in coincidence with the conclusion of AGRESTE'S LANDSAT 2 phase, the JRC will consider the opportunity of a progressive transfer of the acquired know-how to those national laboratories and organizations, which are interested in an immediate application on an operative level.

#### 4.1.2. Investigation of crop stress and diseases by means of R.S. techniques

##### 4.1.2.1. Background

In the European Community, extension of agricultural areas is limited. An improvement in efficiency can result only from an increase of production (genetic improvements, better agricultural practices) or a reduction of losses. This latter factor seems to be presently the most important. Furthermore, in a world conscious of pollution loss, estimates may achieve new significance by providing evidence that will justify or condemn the use of fungicides to control epidemics. Early disease detection could also improve the national use of fungicides.

This type of research is being developed in the USA and Canada. The general strategy of disease loss has been established and the present studies are of an experimental nature. The diversification of European agriculture does not allow Community level, because most of the problems encountered are not the same in the various countries

JRC is at present carrying out the AGRESTE Project using LANDSAT 2 satellite data. This project is devoted to agricultural resource investigations and one of its specific objectives concerns the study of the spectral behaviour from VIS and IR of rice fields and poplar afforestations under different conditions of health.

Particular attention has been paid to some rice diseases such as "giallume" and "pericularia". Results gained have encouraged the extension of this investigation in a more general way to several types of European crops.

##### 4.1.2.2. Technical description

- a) completion of AGRESTE investigations on rice diseases (1977)
- b) study of spectral signatures of various disease affecting crops at different intensity of attack level. These experiments will be done in a green-house, in lysimeters (artificial diseases) or in the field (natural diseases)
- c) execution of M.S.S. high altitude flights (20 to 30 000 ft., resolution 15-20 m). These flights would prepare the utilization of the 3rd generation of R.S. satellites (LANDSAT-3 and EOS) having a similar spatial resolution
- d) Development of a methodology in quasi real time for data processing and interpretation. Digital technique giving objective results will be compared with conventional methods of disease assessment.

- e) development of a strategy to limit the overuse of fungicides taking into account the severity of the disease attack, the propagation conditions and the various ecology factors.

#### 4.1.3. Publications concerning the AGRESTE Project

- (1) Metodologia correlazione Radiometro 4 Canali e relativa Area Investigata
- (2) Rilievi da Terra e dell' Aereo nell I.R. Termico Campi di Riso affetti da "Giallume",  
A. Rilievi da Terra  
B. Rilievi dall'aereo
- (3) Id.
- (4) Agricultural Resources Investigations in Southern France Northern Italy and Madagascar
- (5) Thermal behaviour of some Rice Fields affected by a Yellow-type disease
- (6) Agricultural Resources Investigations in Southern France and Northern Italy
- (7) Determination of Beam Transmittance and Path Radiance in the 4 optical Bands of the Earth-Satellite
- (8) Ein programmsystem zur Verarbeitung und Auswertung von Erds Daten
- (9) AGRESTE'S activity on the Italian Test-Sites-Annual Report 1974
- (10) The mixed Element in Processing of Low Resolution Remotely sensed Data
- (11) Preprocessing Algorithms for Radiometric Corrections and Texture Spatial Features in Automatic Land Use Classification
- (12) Texture Feature and their Role in Classification and change Detection in Remote Sensing
- (13) Sviluppo e Realizzazione di un Radiometro A-4 Canali "LANDSAT"
- (14) Effects of Rice Biomass and Yield on Reflectance in the LANDSAT channels
- (15) Classification Methods used in the frame of the AGRESTE Remote sensing of Earth Resources Programme
- (16) Réponse spectrale d'une culture de Riz irriguée à diverses fumures azotées
- (17) Measurements of Beam Transmittance and Path Radiance for correcting LANDSAT Data for Solar and Atmospheric effects
- (18) Torre Mobile per Misure Radiometriche su Lisometro
- (19) Classification automatique des données du satellite LANDSAT appliqué à Agriculture et Sylviculture
- (20) AGRESTE'S activity on the Italian Test-Sites - First Semiannual report 1975

- (21) Map editing and Map superpositon through Linear Rotation free Transformations
- (22) Supervised Clustering under Homogeneity Restrictions  
An Algorithm and Remarks on its Implementation
- (23) Follow-on investigation "28790" NASA. First quarterly progress report 1975  
Part I : Italian test-sites  
Part II : French test-sites

#### 4.2. SUB-PROJECT : TELLUS (SOIL MOISTURE AND HEAT BUDGET EVALUATION IN SELECTED EUROPEAN ZONES OF AGRICULTURAL AND ENVIRONMENTAL INTEREST)

##### 4.2.1. Background

- a) The TELLUS project, prepared in close collaboration with the General Directorates for Agriculture and for Science, Research and Education in Brussels and several national Institues of seven EEC Member Countries is the subject-matter of a technical proposal presented to the National Aeronautics and Space Administration (announcement of opportunity, May 1975, for the utilization of the EXPLORER-A satellite).

The General Directorate for Agriculture has informed the Permanent Committee for Agronomic Research in Brussels on the JRC's intention to present the Project to NASA. Afterwards the proposal was formally submitted to the same P.C.A.R.

The following proposal is a condensed presentation of the matter dealing with the preliminary edition (August 1975) of the TELLUS Project.

Following the adhesion of two Dutch Institutes, one Belgian Institute and three Irish Institutes, this text must be revised according to the scientific interest of the new partners. The revision will be made during 1976.

As was done for the test-sites selected in France, Germany, Italy and United Kingdom, the test-sites for Benelux and Ireland will be selected in conformity with the Council's directives n 75/268/EEC, 75/269/EEC, 75/272/EEC, 75/275/EEC aimed at assisting some European zones, classified as "less-favoured" from agricultural point of view.

- b) The TELLUS Project is a pilot experiment using Remote Sensing techniques for evaluating moisture content in soil and heat budget modifications for some selected agricultural and agro-industrial European areas.

This project has been built around an announcement for opportunity of the National Aeronautics and Space Administration (NASA) asking for a science support proposal for the "Heat Capacity Mapping Mission - A" (HCMM-A). This programme will use the EXPLORER-A satellite carrying on board two advanced Earth resources radiometers.



The TELLUS Project is aimed at providing the Commission with repetitive comprehensive and synoptic information which will constitute a source of comparative evaluation of the potential for aircraft and satellite Remote Sensing facilities, applied to some sectors of his common policy initiatives.

The hypothesis is that the HCMM-A mission data, together with other existing satellite and aircraft data, should have some significant advantages over conventional methods for providing the requested information. In this sense, the TELLUS Project should give a practical demonstration by covering a significant range of European conditions for agriculture, hydrology, geology and environment.

Furthermore, set up as a collaboration of several national institutes and organizations working together with the Directorates-General for Agriculture, and Research and Education in Brussels, under the leadership of the JRC, the TELLUS Project will allow the concentration of diversified competences and support facilities.

c) The background and accomplishments relevant to the need and the competence for achieving the proposed R and D programmes, are the following :

- During its current 1973-1976 programme, the JRC has acquired a certain competence in Remote Sensing techniques.

Within the AGRESTE Project (Agricultural Investigations in Northern Italy, Southern France and Madagascar) using data from the LANDSAT satellites, many reflectance studies, light transmission field measurements for atmospheric corrections and modelling studies for data interpretation have been developed. A common core of computer programmes for the IBM 370-165 has been developed for processing of satellite recorded magnetic tapes and it is applied in connections with an interactive-mode video-system at the JRC Ispra's Processing Centre. Current use is being made of helicopters, cherry-pickers and aircrafts for photographic and radiometric data acquisition.

In the framework of the air-and-water pollution programme, atmospheric modelling studies have also been carried out.

Full use of this competence can now be profitably concentrated in a unique and more important project such as TELLUS.

- Obtaining Remote Sensing data by means of aircraft and satellites is a matter of international interest, due to the possibility of covering very extended areas. The dimensions of the test-sites, on a European scale, implies that several national laboratories participate in the project for a ground data collection sufficiently comprehensive and for a joint development of methodologies allowing a comparison of results. Together with some other projects of European significance, such as the EURASEP project (using the NIMBUS-G satellite) the TELLUS project is aimed at creating an European competence for satellite data utilization and a consistent participation in future advanced USA experiments.

d) The main motivation for the TELLUS investigation is the potential contribution to the "AGRICULTURE" and "ENVIRONMENT" sectors of the Commission's policy. The specific interest for investigating the HCMM's applications arises from some needs at European level.

- The first point is the increasing demand placed upon the agricultural resources in Europe. Improving agricultural productivity is one of the major concerns of the Commission, and by means of the DG-VI the Commission is putting into effect some directives of the Council towards a better management of agricultural resources in Europe.

Some of these directives are aimed at assisting the European zones classified as "less-favoured" on an agricultural basis, owing to their permanent natural handicaps, which are chiefly due to the poor quality of soil and the short growing season. These less-favoured zones are made up of farming areas which are homogeneous from the point of view of natural production conditions, and made up of infertile land, difficult to cultivate or to intensify and mainly suitable for extensive livestock farming.

The General Directorate for Agriculture's effort is aimed at preventing the dwindling of population from such areas, predominantly dependent on agricultural activity and the accelerating decline of which would jeopardize the viability of the areas concerned and their continued habitation. The less-favoured zones include also areas in which farming is necessary to conserve the countryside, particularly for reasons of protection against erosion and to preserve the tourist potential or in order to protect the coastline.

Another main concern of the General Directorate of Agriculture is the surveillance of abandoned land in order to assess its degradation and the potential effects of various factors on this degradation, among the most important of which is the soil moisture.

Therefore, the General Directorate for Agriculture consider it very important to have at their disposal in the future a repetitive, comprehensive and synoptic means of monitoring the status of soils in correlation with various vegetative conditions:

- (i) for conservation of the less-favoured areas,
- (ii) more generally, for a better management of other European agricultural areas.

Investigating the feasibility of applying Remote Sensing techniques for monitoring soil moisture in various vegetation cover conditions constitutes, for the TELLUS Project, a specific General Directorate of Agriculture's recommendation.

- The second important point deals with the need for the promotion of a communitarian policy in the field of environmental protection. General Directorate for Science, Research and Education is particularly concerned with environmental problems. One of its important tasks is the coordination at a European level of the research on environmental protection (i. a. via extra muros contracts). On the other hand, the Biology Division of the General Directorate for Science, Research and Education carries

out its own research programme trying to evaluate the biological and ecological risks on terrestrial and aquatic ecosystems arising from the use of nuclear energy. This task is particularly significant in a period when a considerable increase in nuclear plants is expected in Europe (from 20 GWe to some 180GWe in the period 1975-1985).

This will cause an increase in exposure level to professional workers and to people living in the vicinity of nuclear power stations. At the same time, the radiological and thermal impact on the environment is likely to increase.

It is therefore necessary that the authorities who have to take decisions about these subjects should dispose the scientific data in a complete and up to date manner which may allow them to handle the different problems that could arise and upon which the public opinion is particularly sensitive. With this in mind, the General Directorate for Science, Research and Education intends to participate in the project, in an effort to evaluate the influence of nuclear plants on the heat budget of specific territories or water bodies, in particular of natural affluents.

#### 4.2.2. Technical description

##### 4.2.2.1. Soil moisture

Among the many variable influencing agricultural productivity, such as soil composition, insolation, temperature, cultural techniques (i.e. fertilization, ploughing, etc) and soil moisture, the latter is quite significant. This is valid for both situations of hydrologic deficiency, for hot semi-arid zones, and of hydrologic excess, for saturated zones.

In the first case, lack of water content in soil narrows the range of agricultural choice and causes the agricultural productivity to be reduced. Only by applying irrigation techniques, can one provide the terrain with the optimum moisture content for cultivation. In the second case, saturation of the soil is important both from agricultural point of view, and for monitoring the occurrence of flooding.

Until now, conventional ground measuring techniques for evaluating moisture content in soil are valid only for small soil patches. Thus networks composed of a great number of agro meteorological ground stations are needed for hydrological data acquisition. From these reasons the need arises for measuring soil moisture in a synoptic and more economic way.

The objective are :

- a) Mapping diurnal soil temperature variations for measuring moisture content in top soil layers for terrains of good geologic exposure, such as those existing in cultivated agricultural areas during the period ranging from crop harvesting to sowing (see attached diagram n. 1). Repetitive information on soil moisture content during this period (some months) will be interesting on a multiannual basis because it provides good statistics, useful for a better crop decision making within the mapped area. In particular it should be useful to have

soil moisture informations just before sowing, i.e. during the phase of preparation of soil sowing-bed.

- b) Mapping canopy temperature at frequent intervals, during the vegetation growing season, in order to evaluate the evapotranspiration and stress conditions of the vegetative biomass.
- c) Evaluating the masking effects caused by different meteorological conditions as given in different altitudes for similar types of soil and environment.
- d) Evaluating the effects of different soil vegetation covering and its seasonal variation on the accuracy of soil moisture detection by Remote Sensing.
- e) Determining the soil moisture influence on agricultural productivity. Quality and quantity of biomass being strongly influenced by soil moisture content, it is proposed to investigate this relationship by identifying the methodologies and the techniques appropriate for the application of thermal radiometric Remote Sensing. This point may be considered as an extension of point b) and d). It is proposed to investigate the relationship on a seasonal basis in order to try to evaluate the final influence of soil moisture evolution on crop yield.

It has been considered of great interest to make contemporary comparisons of the results of such investigations for the same crops cultivated at the same period in different zones (hot semi-arid and sub-humid), in otherwise different environmental situations (soil type, insolation, wind, temperature, etc...) and equal cultural techniques.

f) Detection of moisture-saturated areas

The objective is assessing soil moisture changes for detection of saturated soil areas. As sequential Explorer-A coverage becomes available, such sequential mapping would be important, for purposes of monitoring and decision in agriculture : flood forecasting (together with the complementary meteorological information) and need for drainage.

g) Detection of distribution of ground water and soil moisture for evaluating relationship with the spatial distribution of accelerated erosion.

Accelerated erosion is one of the key problems of semi-arid regions especially in areas of unconsolidated bedrock materials. Understanding the factors accounting for the spatial distribution of erosion, both in fluvial forms and as mass movements, is a vital task for efficient agricultural development and such problems as road location in such areas. The regional distribution of accelerated erosion is a function of many variables, one of the most important of which is the location of the groundwater table and the distribution of areas of high soil moisture.

The test sites are :

- a) For experiments on cultivated areas (mainly for objective e)) some controlled training samples have been selected in test sites in Italy :
- in hot semi-arid zones for experiments on citrus and olive orchards, for irrigated and un-irrigated conditions (test site No. 1 in Apulia; test site No. 2 in Sardinia)
  - in a sub-humid zone for experiments in corn and alfalfa, for irrigated and un-irrigated conditions (test site No. 3 in Emilia)
  - in hot semi-arid and sub-humid zones for comparative evaluations on wheat, sugar-beet, vines for irrigated and un-irrigated conditions (test site No. 3 in Emilia; test site No. 2 in Apulia),
  - in a typical "less-favoured" hot semi-arid zone for experiments on pasture lands (test site No. 2 in Sardinia)
- b) For experiments on saturated soil areas (mainly objective f)) some controlled training samples have been selected in test sites in the United Kingdom :
- For lowland arable area on Jurassic clay (test sites No 8 and 9 in England),
  - For upland grassland; plat, glacial deposits over paleozoic mudzones (test site No 10 in Wales)
  - For mixed coniferous forest on upland catchments as above (test site No 11 in Wales),
- c) For experiments connected with the spatial distribution of accelerated erosion, one training sample has been selected in test sites in Italy :
- including areas of both erosion and low erosion rates in otherwise similar environmental situations. Areas with two different types of erosion have been selected, namely badlands topography and extensive landslipping (test site No 2 in Basilicata)

#### 4.2.2.2. Heat Budget

The heat budget is a relevant environmental characteristic for agricultural areas, due to the impact on animal life and vegetation. Agricultural productivity may be strongly affected by heat budget variations owing to both natural (i.e. meteorological) and manmade modifications. Wild life could be affected up to the complete extinction of certain species.

Therefore any relevant heat budget modification should be anticipated by an ecological study. The HCMM mission boards the means of evaluating the heat budget modification of some agricultural and agro-industrial regions selected in the TELLUS Project.

## a) Natural modifications influencing regional heat budget

The objectives are:

- Evaluation and monitoring of the consequences of low atmospheric layer movements (mistral wind, sea breeze and land breeze) on some important phenomena, such as:
  - (i) Tendency for frost in particular agricultural zones.  
By means of a quasi-real time thermal mapping, one could be acquainted with the "tendency to frost" of such areas. A "tendency to frost map" could be prepared in order to provide information for the most rational planting of first vegetables and vines.  
"Tendency to frost" is a pretty dynamic factor, which mainly depends on different soil temperature distribution and cold air mass movements (particularly along valleys). It is a particular non-local phenomena, which can be monitored only by satellite. This point is particularly important for the Rhone valley in France, whose economy is mainly based on agriculture.
  - (ii) Atmospheric pollutant distribution  
It is a phenomenon depending on the formation and circulation of low altitude breezes, created by non-uniformities in soil temperature distribution. The influence of pollution-resistant woods and tree-rows for shielding, will be thoroughly investigated. It is proposed to apply the above methodology to the study of parasites dissemination into the agricultural migration area.
  - (iii) Monitoring of burned zones.  
By means of the HCMH's 0.5 - 1.1  $\mu\text{m}$  channel, burned zones are easily detectable. The growing up of new vegetation takes several months and can be monitored in time by following the heat budget evolution of the burned area by means of the HCMM'S (10.5 - 12.5)  $\mu\text{m}$  channel.
- Correlation between thermal, hydrogeological and topographical characteristics of soils and the occurrence of hail storms

On the assumption that hail storm formation is determined by local non-uniformities of temperature on the ground, as well as by evapo-transpiration from soil and vegetation, it is proposed to study the influence of the heat budget variation on the formation of hail storms on a mesoscale basis (some 100 km<sup>2</sup>).

The ultimate objective of this study shall be the optimum location of preventive systems against hail. In fact, forecasting and warning of hail storms is rather generic for what concerns the localization. In the best situation, alarm is given over an area of some millions of hectares, while a big hail storm hardly concerns more than 50.000 hectares.

The purpose of this research is to give a contribution to the determination of the parameters which cause the starting and the development of such storms, in order to localize them. The soil thermal maps to be determined by means of the AEM-A mission (and which cannot be obtained by means of conventional instrumentation) are a fundamental starting point for the solution of this problem.

- Identification lithologies of solid rocks in soil and vegetation areas.

One proposes to demonstrate the potential of space imagery for the recognition and definition of large area lithological and structural patterns which, with appropriate field sampling, may be used for small scale geological mapping. Thermal mapping appears to hold promise for the possibility of relating rock-type to its thermal properties but in soil and vegetated areas, the relationships are complex, although in such areas geological mapping could be considerably assisted by the development of a methodology for the distinction and classification of rock types according to thermal properties.

It is proposed to examine the potential of the HCMM radiometer for distinguishing rock types in zones with distinctive rock types covering "large" areas. The specific objectives will be to identify the methodologies and techniques appropriate for the application of thermal radiometry to rock type recognition.

b) Man-made modifications influencing regional heat budget

Significant man-made modifications in land-use can strongly influence the local heat budget. In particular, the installation of industrial plants (factories, nuclear and conventional power stations) can affect significantly the heat balance of water bodies and surrounding farmland and woodland.

The overall impact evaluation of the heat budget variation on a regional area where agricultural and industrial activities are mixed is one of the most important problems for the conservation of a good environmental quality. This situation is typical for the Rhinegraben region between Basel and Mannheim-Ludwigshafen which may be considered a model for other similar areas (intensive agricultural landuse, growing industry with high energy consumption which makes atomic power stations necessary, increasing density of population).

The objectives are:

- Determining temperature, thermal inertia and derivated parameters for homogeneous minimum patches, consistent with the HCMM's resolution and classified as: farmland, woodland, urban land without industry, industrial areas, water, and to investigate the limits of HCMM's resolution.
- Determining the extent to which HCMM data can provide information usefull for a repetitive periodic monitoring of the natural conditions, in regard to the ground water stock, for regions with extended agricultural use and a high rate of industrial growth.
- Determining the influence of strong local effluents on short term and long-term variations of the heat budget, i.e.:

- (i) thermal interaction between heat islands and environmental farmland and woodland,
  - (ii) screen house effect by water vapour clouds produced from large cooling towers (increased atmospheric radiation on days without haze in the surroundings) and its proof by satellite measurements,
  - (iii) variations of the local climate caused by water vapour of cooling towers in the presence of meteorological inversions (which frequently appear in the Rhinegraben valley).
- Investigation how natural and manmade heat sources and sinks (cities, industrial plants, cooling towers, lakes and rivers) can be seen on the upper surface of extended haze fields. From day/night comparisons the air circulation system under inversion layers should be derivated.

It is further intended to study theoretical models for the development of water vapour clouds from cooling towers and to proof their application under special meteorological conditions, as inversions by means of thermal space imagery.

#### c) Test sites

- For all experiments concerning the impact of low atmospheric layer movements, one test site has been selected in France, which can be considered as a suitable model for other similar situations due to the great variety of topographic and pedologic characteristics (test site No.4, Rhone valley, Languedoc and Provence).
- For experiments concerning forecasting of hail storm localization, the Po valley has been chosen (test site No.3 Emilia)
- For experiments aimed at the identification of various lithologies, one test site has been chosen in England: a test-area has been selected in parts of Berkshire and Oxfordshire. Primary test-areas will be chosen in two different rock types but with the same land-use, namely on chalk and clay. Secondary test areas will be selected on different superficial drift rocks but with the same bedrock and the same land use and vegetation covers.
- For all investigations on manmade modifications influencing regional heat budget, test sites have been chosen in Germany:
  - (i) in the Rhine Valley (test site No.1)
  - (ii) in the Rhine Valley (test site No.2)
  - (iii) in the Northern Alps region (test site No.3)



#### 4.2.2.3. Remote sensors and platforms

- a) Data obtained from NASA and gathered by the EXPLORER-A satellite.

The EXPLORER-A satellite, scheduled to be launched early in 1978, will carry two scanning radiometers, whose spectral bands are resp. 0.5 - 1.1  $\mu\text{m}$  for measuring the solar energy part reflected by the Earth and 10.5 - 12.5  $\mu\text{m}$  for measuring emitted terrestrial energy (i.e. surface temperature). The onground resolution is expected to be (0.5 x 0.5)  $\text{km}^2$ .

The main characteristics of the EXPLORER satellite will be to pass regularly (every six days) over the same area, consecutively during the day (at 1.30 p.m.) and the night after (at 2.30 a.m.).

Measurement of day- and night temperature differences enables thermal inertia and soil moisture evaluation of the investigated area.

The EXPLORER system is compatible with the LANDSAT system. Data will be received in the real-time in Europe through existing NIMBUS and/or LANDSAT receiving stations, so allowing a better temperature and thermal inertia data utilisation.

- b) Data obtained from NASA and gathered by LANDSAT-2 and LANDSAT-3 satellites.

Launched on January 22nd, 1975 the LANDSAT-2 satellite is equipped with a multispectral scanner (four channels in the visible and near I.R. 0,5 - 1.1  $\mu\text{m}$ . Its life expectancy is 3 - 4 years. The ground resolution is (80 x 80)  $\text{m}^2$ .

LANDSAT-3 is scheduled to be launched at the end of 1977. In addition to the 4 reflective channels, a thermal I.R.-channel is foreseen for temperature mapping. A return Beam Vidicon System will provide optical wavelengths information with a (40 x 40)  $\text{m}^2$  resolution. Data from these satellites can be obtained via the receiving station at FUCINO, Italy.

- c) Data gathered by means of aircraft and helicopters.

Some aircrafts in Europe are equipped for multispectral observations in the visible, near I.R. and thermal I.R. (Daedalus, Bendix and Super Cyclope scanners). In addition, radiometers can be placed on board of helicopters, either for direct observation, or for correlating aircraft and/of satellite data with lower altitude measurements.

#### 4.2.2.4. Statement of work

After Benelux and Irelands' joining the TELLUS Project, the task of distribution among JRC and collaborating partners need to be re-assessed. In the mean time the following main lines can be tentatively presented:

##### a) Ground-Truth Data Acquisition

###### - Conventional data:

- (i) data from hydrological and pedological observations, meteorological data, agro-bio-climatological data, etc..., will be provided by the specialized collaborating institutes. Vegetation, land-use and hydrological maps will be used, if available; where necessary land-use, pedological and vegetation maps will be produced from LANDSAT data.

It is assumed that the vegetation resources of training samples are well known at the moment of the proposed experiments. In fact the greater part of the institutes have experimental farms with many kinds of agronomic and horticultural research in the corresponding test areas.

A great deal of supplementary ground-truth observations will be needed but most of them will draw on procedures developed by the institutes during their own present work.

- (ii) Data collection platforms for automatic transmission of data are foreseen. Their use will bring the following advantages: simplification of ground data transmission (owing to the difficulty of access to some test-zones), possibility of shifting the DCP network from one test-zone to another without excessive complication, constitution, by means of this pilot experiment, of a valid example for an operational any-purpose use of DCP's in Europe.

###### - Radiometric data:

Data from radiometric measurements will be acquired by means of mobile experimental stations (JRC and some institutes) equipped with EG and G-Barnes 12550, Barnes PRF-5, AGA, Thermovision and EXOTECH Radiometers. Photographic cameras and cherry-pickers will also be available.

## b) Laboratory and on-ground experiments - Modelling studies

This part will mainly concern soil moisture investigation. This work will be performed using the following approach:

- Laboratory experiments on soil samples, for definition of sensitivity limits of the measuring techniques. Verification of the existing thermal inertia models for bare soil samples by means of climatologic and diurnal radiometric measurements.
- Tentative development of mathematical relationship of soil-vegetation interaction. Setting up by means of carefully selected agro-bio-climatological lysimeter experiments on a few selected representative crops. Spectroscopic measurements to be made in parallel for spectral signature identification during the phenologic cycle.
- Verification on the results obtained extrapolating to field conditions. In case of success, improvement of the thermal inertia algorithm by introducing the soil-vegetation system. Seasonal checking on two selected crops.
- Measurement of the gradient of air humidity and temperature (eventually up to approx. 2000 m altitude by means of balloon sounding), wind direction and velocity.
- After the setting up of the model, making comparisons between crops on irrigated and un-irrigated conditions. The institutes will establish a control of vegetative conditions of crops.
- Performing day-and night thermal IR and VIS aircraft flights on a broad test-area.

Ground-truth radiometric measurements will be performed in coincidence with the aircraft passes. A minimum of 5 flights will be suitable. Flights dates will be possibly chosen in coincidence with corresponding LANDSAT overflights. The aim is to integrate the LANDSAT reflectance information on soil moisture and vegetation with the more detailed aircraft information.

- A special effort will be made in this framework by JRC and some others institutes. In particular, a tentative development will be made to establish a circulation model for air layers in the peplosphere in inversion layers and over extended water surfaces. It is intended also to establish interpretative models and criteria for the explanation and evaluation of the influence of different environmental parameters on the ecology in the test area. In particular, a model will be set up for interpreting the distribution behaviour of air pollutants and parasites on test site No.4

#### 4.2.2.5. Data Processing

- a) Before launch, the JRC would prepare essentially the data processing methodology by adapting the existing computer software and developing new programmes, and routines for AEM-A mission resources classification and display based either on user-specified decision parameters or pattern recognition techniques. This work, to be done on local computer support facilities, will provide the multidisciplinary teams both on and off JRC, with a software package consistent with the goals of aircraft, LANDSAT and HCMM interrelated data investigation.
- b) The following steps are foreseen for the after-launch operations:
  - Prepare resource and land-use analysis and digital mapping of selected LANDSAT areas. This area will be classified on the basis of available ground-truth and limited essential field checking.
  - By regrouping pixels, prepare MSS-based maps for the same area but at the HCMM ground resolution.
  - For selected HCMM frames, conduct experiments to determine the accuracy of delineation and identification of image area, comparing with existing conventional thematic maps, and low resolution LANDSAT maps obtained, including contrast enhancement techniques.
  - Combine the day-and-night HCMM and LANDSAT data into a single multichannel framework.
  - For selected frames, conduct experiments of classification by means of information extraction from both VIS and near-IR range of HCMM data, making use in particular of the thermal inertia algorithms and further information which appeared to be indispensable during the pre-launch date. Repeatability within and between frames will be tested.
- c) After setting up the techniques, pass to a regular production phase.

4.3. PLANNING

<u>ENVIRONMENT AND RESOURCES</u> Agricultural Resources				
PLANNING	1977	1978	1979	1980
I. <u>Post-Agrete sub-project</u>				
. Completion of Agreste-I				
. Crop stress and diseases				
II. <u>Tellus sub-project</u>				

4.4. MANPOWER AND COSTS

PROGRAMME : ENVIRONMENT AND RESOURCES				
PROJECT 4 : RESSOURCES				
	1977	1978	1979	1980
RESEARCH STAFF	20	20	20	20
INVESTMENTS (K.U.A.)	600	--	--	--
RUNNING COSTS (K.U.A.)	80	90	90	90
CONTRACTS (K.U.A.)	50	60	30	40

ADVISORY COMMITTEE  
ON PROGRAMME MANAGEMENT

"ENVIRONMENT"

OPINION

The Committee examined the draft proposal to be submitted by the Director General of the Joint Research Centre to the General Advisory Committee in the field of "Environment and Resources", exclusive of budgetary details.

The Committee recognises the general interest for the action programme of the European Community of the proposed direct programme. It did not express an opinion on the project "Agricultural Resources".

The Committee formulated the following opinions on the other projects:

Project I - Atmosphere

The Committee places first priority on the action "Particle Formation and Transport of Pollutants", recognising the emphasis given by the JRC to field measurements and intercomparison campaigns. Within this large project further consideration should be given to the internal priorities.

The Committee places equal second priority on the actions ILE and SO<sub>2</sub> uptake. The latter should continue along present lines until a decision on the follow-up of COST 61 a, is made.

The Committee agrees to maintain the limited action entitled "Urban air modelling".

Project II - Water

The Committee places first priority on the completion of the action "Eutrophication", focussed on the examination of the basic parameters which control the phenomena.

Although not all delegates allocate a high priority to the action, the Committee as a whole recognises the importance of the proposal "EURASEP", and supports it since the test sites to be selected can cover most of the European seas, and the proposal of the JRC offers an exceptional opportunity to national laboratories to participate in this collaboration with NASA.

The Committee assigns the present proposal for the action "Chemical and Thermal Pollution of Water", a low priority. It suggests that the action be described in greater detail, arriving at a definition of the influence of temperature on the effects of chemical pollution and on eutrophication. It has strong reservations concerning the utility of the artificial water course.

Project III - Chemicals

The Committee gives first priority to the action ECDIM which should continue for another two years in a experimental phase, during which its structure and operation will be discussed with potential users.

The Committee did not receive sufficient information to assess the importance of the action "Heavy metals from fossil fuelled power plants". It considers that the contribution of the various fuels to the global heavy metal burden of man should be studied first. In addition arsenic and radioactive substances should be taken into account.

The Committee recommends that the JRC participates in the follow-up programme of COST 64 b, given the initiating rôle played by it in this COST action.

The Committee recommends to the JRC that it should review the possibility of participating in a joint action regarding the impact of fluoro-chlorohydrocarbons, and other compounds, on ozone depletion in the atmosphere.

**9. METRE (MEASUREMENTS, STANDARDS AND REFERENCE TECHNIQUES)**



APPENDIX E-I-09

PROGRAMME

METRE (MEASUREMENTS, STANDARDS & REFERENCES TECHNIQUES)

TABLE OF CONTENTS.

INTRODUCTION

1. PROJECT : MEASUREMENTS OF NUCLEAR DATA

1.1. SUB-PROJECT : NEUTRON DATA

1.1.1. Background

1.1.2. Technical Description

1.1.3. Connections with External Organizations

1.2. SUB-PROJECT : NON NEUTRON NUCLEAR DATA (N.N.N.D.)

1.2.1. Background

1.2.2. Technical Description

1.2.3. Connections with External Organizations

1.3. MANPOWER AND COSTS

2. PROJECT : NUCLEAR REFERENCE MATERIALS AND TECHNIQUES

2.1. BACKGROUND

2.2. TECHNICAL DESCRIPTION

2.2.1. Preparation and Characterization of Nuclear Reference  
Materials to Support Analytical Measurements

2.2.2. Manufacture and Characterization of Special Nuclear Samples  
and Targets

2.2.3. Analytical Measurements in Support of Safeguards

2.3. MANPOWER AND COSTS

2.4. CONNECTIONS WITH EXTERNAL ORGANIZATIONS

3. PROJECT : NON-NUCLEAR REFERENCE MATERIALS AND  
TECHNIQUES

3.1. SUB-PROJECT : CHEMICAL PROPERTIES

3.1.1. Background

3.1.2. Technical Description

3.1.2.1. Reference Materials for Industrial Needs

3.1.2.2. Reference Materials for environmental pollution studies

3.2. SUB-PROJECT : PHYSICAL AND TECHNOLOGICAL PROPERTIES

3.2.1. Background

3.2.2. Technical Description

3.2.2.1. Physical properties and Measurements

3.2.2.2. Technological properties and Measurements

3.3. MANPOWER AND COSTS

4. PROJECT : SCIENTIFIC SUPPORT TO THE SERVICES OF THE  
COMMISSION

4.1. BACKGROUND

4.2. TECHNICAL DESCRIPTION

4.3. MANPOWER AND COSTS

5. PROJECT : SCIENTIFIC SUPPORT TO THE SECRETARIAT OF  
B.C.R.

5.1. BACKGROUND

5.2. TECHNICAL DESCRIPTION

5.3. MANPOWER AND COSTS

## PROGRAMME

M E T R E (MEASUREMENTS, STANDARDS  
AND REFERENCE TECHNIQUES)INTRODUCTION

METRE (Measurements, Standards and Reference Techniques) is a proposed interlaboratory programme involving the JRC laboratories of Geel (Central Bureau for Nuclear Measurements - CBNM), Ispra and Petten establishments. As in the case of the indirect action Reference Materials and Methods (BCR), the basic idea underlying the programme is the applied science of measurement in the field of references and standards. As such it naturally fulfils the important criterion of common service; it has the elements of the role of a Community metrology service in a few selected areas where the need is urgent. It is conceived to cover many fields of application in both the nuclear and non-nuclear sector. In this context "nuclear" is the part of the programme whose main aim is to support the nuclear energy industry, whereas "non-nuclear" is used to denote that part which does not support directly the nuclear energy industry.\*)

Historically METRE has been built up by combining the nuclear measurements and reference activities of CBNM with the BCR type activities of the Ispra and Petten establishments. Broadly this gives the division between nuclear and non-nuclear, although there are minor differences, mainly arising from the fact that a small part of the proposed CBNM activity is the non-nuclear sector. This follows from the fact that it is now fully recognised that some of its built-in nuclear expertise is well suited to some non-nuclear applications.

---

\*) It should be noted that the words 'whose main aim' are used since it becomes rather cumbersome to structure the proposals if the definitions are used rigidly.

The "nuclear" part of the METRE programme is a logical continuation of the present CBNM activity with considerable emphasis placed on the exploitation of the two major accelerators which have recently been modernised. The programme includes measurements of important nuclear data, the knowledge of which is basic to reactor design and the preparation and characterisation of reference materials which are essential ingredients to analytical measurements in the nuclear field. All this part of the programme has been examined critically by the Advisory Committee for Programme Management (ACPM)-CBNM and has received its full support. Members of the committee have indeed contributed significantly to help CBNM draw up a list of some nuclear data (the so-called non-neutron nuclear data) which are urgently required by the Community.

The "non-nuclear" part also follows naturally from the expertise built up at Ispra and Petten in the field of reference materials required for control in many fields of industry and commerce. The proposed activities fit essentially with the indirect action Reference Materials and Methods, BCR, covering the Community-wide cooperation on reference materials and methods. The JRC activities range from the provision of necessary and useful specialist scientific support to the BCR secretariat to practical work on the preparation and characterisation of reference materials. This non-nuclear part of the METRE programme has been examined by the ACPM-BCR, and here again full support has been given.

The programme is subdivided into five projects as follows:

1. Measurements of Nuclear Data.
2. Nuclear Reference Materials and Techniques.
3. Non Nuclear Reference Materials and Techniques.
4. Scientific Support to the Services of the Commission.
5. Scientific Support to the Secretariat of the BCR.

At the end of each project a table summarizes the required manpower and costs.

At the end of the document the total requirements for METRE are given.

S U M M A R Y

PROGRAMME : METRE							
	Research Staff (per year)	Investments (MUA)	Total running expenditures (MUA)	Resources (MUA)	Required Budget (MUA)	Expected Income (MUA)	
PROJECT 1 CBNM	56	1.070	1.615	0	2.685	0	
PROJECT 2 CBNM	48	1.185	1.215	0	2.400	0.130	
PROJECT 3 ISPRA	44	0.640	1.200	0	1.840	0	
PETTEN	8	0.200	0.200	0	0.400	0	
CBNM	6	0.100	0.160	0	0.260	0	
PROJECT 4 ISPRA	5	0	0.060	0	0.060	0	
PETTEN	4	0.070	0.070	0	0.140	0	
PROJECT 5 ISPRA	8	0	0.350	0	0.350	0	
PETTEN	1	0	0.020	0	0.020	0	
CBNM	1	0	0.030	0	0.030	0	
TOTAL	181	3.265	4.920	0	8.185	0.130	

1) Expected income from sale of samples reference materials

352

	Research Staff	Equipment	Running Cost	Contracts	Total Budget
ISPRA	57	.640	1.070	.540	2.250
PETTEN	13	.270	.290	--	.560
CBNM (Geel)	111	2.355	2.220	.800	5.375
TOTAL	181	3.265	3.580	1.340	8.185

## 1. PROJECT : MEASUREMENTS OF NUCLEAR DATA

This project is divided into two sub-projects, one concerned with data pertinent to neutron induced reactions and the other with nuclear data not directly concerned with the interaction of neutrons, hereafter called non neutron nuclear data (NNND).

### 1.1. SUB-PROJECT : NEUTRON DATA

#### 1.1.1. Background

The interactions of neutrons with matter are basic to all nuclear energy programmes. To take perhaps the earliest and indeed a simple case, that of the calculation of the critical mass of  $^{235}\text{U}$ , the basic neutron-interaction parameters of this nucleus required, all as a function of neutron energy, are the fission cross-sections, the number of neutron emitted per fission, the capture and scattering cross-sections. Since the isotope  $^{238}\text{U}$  is also present in the material, the equivalent cross-sections of this isotope will also be required. It is worth noting that these parameters all have different weights in the calculations and that by far the most important are the fission cross section and the number of neutrons emitted per fission. This weighting, or sensitivity of a parameter to this calculation, can help to define the priority of the requirement, and it still has relevance in the very complicated reactors, presently being constructed or under discussion.

Although in the past much work has been done on measuring and evaluating these parameters, the reactor community still demands more accurate and sometimes new data. On a world-wide basis these demands are collated by the International Atomic Energy Agency (IAEA) into a list called WRENDA (World Request List for Neutron Data Measurements for Nuclear Reactors), priorities being given to the various requests on the basis of the importance of the reactor system and its sensitivity in the neutronics calculations.

There is presently a good deal of emphasis on data concerned with the fast breeder reactor and also data concerned with the study of long term irradiation effects, both from the standpoint of burn-up of fuel and damage to structural and canning materials.

Besides the requirements for reactor systems one also finds those for neutron shielding and, in the future, one can expect items concerned with destruction of nuclear waste and with thermonuclear reactors and possibly other applications.

There are many important Community requirements for new and improved data which are common to member countries

Although resources for carrying out these measurements exist within the member states, they are decreasing and this in turn is strengthening the view that the CBNM effort, acting as a common service, is required.

In taking the decision to reduce national facilities, some member countries have noted that the CBNM facilities are presently being modernised, and have relied on future exploitation of these facilities on a common basis.

#### 1.1.2. Technical Description

When the present 4-year plan expires at the end of 1976, CBNM's major research instruments, the Linac and the Van de Graaff accelerator facility will just have been modernised. These improved installations will then have neutron intensities and energy resolutions comparable to those available at the most competing installations which are operating in the United States at Oak Ridge National Laboratory (electron linear accelerator) and Argonne National Laboratory (Van de Graaff accelerator). The accessible neutron energies will cover almost all the energy range of interest in the field of fission and fusion reactors with a considerable overlap between the neutron energy ranges of the two machines. Further benefit, mainly from the improvement in neutron energy resolution or alternatively, the intensity for short burst widths, could be obtained by pre-acceleration *bunching* of the electron beam of the Linac, and the feasibility of this will be studied.

It will be recalled that a beam of thermal neutrons from the BR-2 reactor of SCK/CEN-Mol, Belgium, has also been available for CBNM experiments by means of an exchange collaborative contract, and it will be assumed that this contract will be continued.

It is proposed to concentrate on the following four main lines (a) to (d) below, although it should be noted that flexibility can and indeed should be maintained to adapt to different measurements if new needs show up. Where possible, this programme has been specially selected to meet the pressing needs of the Community Countries, although of course some of it is of wider interest.

- (a) Accurate determination of neutron data requested for the most important actinides. (Measurements of certain data on actinides are also proposed into the programmes of the JRC, but these will not duplicate those made on the CBNM accelerators).
- (b) Measurements of cross sections for structural materials. These measurements especially call for the improved resolving power of the Linac neutron spectrometer as well as for the enlarged energy range available with the improved Van de Graaff accelerator facility. Measurements at the Van de Graaff will include charged particle emission cross sections - in view of their importance for the long term behaviour of reactor components.



- (c) Determination of capture data (cross sections and resonance parameters) for important fission products. These measurements meet the special interests of Italian, Dutch and French groups, but are also clearly of overall general interest.
- (d) Continuous effort in the field of neutron data standards by improving methods and performing data determinations of high quality and by accurate determinations of neutron fluxes and neutron source strengths. Evaluations of some of the standard cross sections will also be carried out.  
This work involves a critical appraisal of the experimental and theoretical information available and advising on the best parameter values to use.

It is also suggested that the accelerator facilities be placed at the disposal of the national laboratories for neutron measurements on simple and clean integral assemblies. Some modifications to the Linac and its building would be needed to make this possible.

### 1.1.3. Connections with External Organisations

It has already been mentioned that the requirements for nuclear data are collated by the IAEA. Indeed the whole programme of nuclear data measurement and evaluation and its relationship to reactor physics is reviewed and discussed on a regular basis by international committees and CBNM is represented on these. The two important ones are the International Nuclear Data Committee (INDC), organised on an IAEA basis and the Nuclear Energy Agency Nuclear Data Committee (NEANDC) organised on an OECD basis.

From time to time meetings specialists to discuss points of detail are organised via these committees.

The countries of the Community are either represented directly on these committees or special arrangements are made for the dissemination of information.

Some measurement programmes are also carried out in some national laboratories as well as in CBNM. Regular contact is made with these laboratories in order to ensure no unnecessary duplication and also to coordinate some very difficult measurements requiring the support of more than one laboratory. The exchange collaborative contract between SCK/CEN Mol and CBNM covers not only the mutual use of the neutron beams from the BR2 on the one hand and the CBNM Linac on the other, but also collaboration between staff from the two establishments. Altogether the equivalent of about 4 A Grades and 2 Technical Grades from SCK/CEN collaborate with CBNM on neutron data measurements.

## 1.2. SUB-PROJECT : NON NEUTRON NUCLEAR DATA (N.N.N.D.)

### State of the Art

These data are mainly concerned with the decay properties of radionuclides, measurements on stable isotopes and the interactions of charged particles with nuclei. They underly many activities, not all connected with nuclear energy, e.g. industrial, agricultural and medical uses of isotopes and radiations. All these applications were discussed at an IAEA conference in Paris in 1973 (see Nuclear Data in Science and Technology. Proceedings of a Symposium, Paris 12-16 March, 1973, Vienna), and the need for more reliable nuclear data was strongly stressed. Many measurements have already been done, but in the future it is necessary to concentrate on detailed evaluation of what is already available and the further measurement to high accuracy and more reliability. These applications cover many diverse topics and because of this it is difficult to review the exact details of the requirements on a regular basis as is done in the field of neutron data. However, the process of getting proper reviews made has now been started; National Nuclear Data Committees, which previously were only concerned with neutron induced nuclear data are being widened to include non-neutron nuclear data along with the international committees, INDC and NEANDC. CBNM is represented on these international committees.

### 1.2.1. Background

The CBNM can bring many years of experience concerned with measurements of stable and radioactive isotopes to bear on the field of non-neutron data. Since the applications are now becoming more sharply focussed and are in any case of wide general interest, it is logical for the CBNM to continue in the field.

### 1.2.2. Technical Description

Three main lines of measurement are proposed; of course flexibility must be maintained to adapt to important needs as they show up.

- (a) Measurement and evaluation of decay scheme data such as  $\gamma$ -ray intensities, internal conversion coefficients, branching ratios and half-lives for radionuclides with complex decay schemes.

Particular emphasis will be given to decay schemes of actinides, fission products and those containing low energy  $\beta$ -emission, several  $\beta$  branches, electron capture and mixed electron capture/positron decay, and low energy  $\gamma$ -transitions with a high degree of internal conversion.

Many of the radionuclides with these decay scheme characteristics have only recently become commercially available with the increased utilisation of charged particle accelerators for radionuclide production.

- (b) Measurement and evaluation of atomic constants such as X-ray intensities, fluorescence yields and Auger electron yields, especially for electron vacancies originating in the L shell, where the data are inadequate or non-existent.
- (c) Measurement of charged particle reaction cross sections.

It is proposed to consider the engagement on a limited programme of measurements of charged particle reaction cross-sections (depending on eventual demand) using the modernised Van de Graaff bearing in mind application to activation analysis and possibly to the design of a fusion reactor.

### 1.2.3. Connections with External Organisations

The requirements for these data and the status of measurement etc. are discussed by the international nuclear data committees on which CBNM is represented. In addition the aspect of the high accuracy on some of the measurements is discussed by the BIPM Consultative Committee for Measurement Standards of Ionizing Radiations.

The CBNM formulates its programme to support the countries of the Community by discussion with experts from these countries, but of course the programme is likely to fit into wide international context.

Since non-neutron nuclear data measurements are also carried out by national laboratories, regular contact is maintained in order to avoid unnecessary duplication. In addition CBNM occasionally participates in International intercomparisons of radioactivity standards in order to upgrade the overall quality of work.

1.3. MANPOWER AND COSTS

PROGRAMME : Metre				
PROJECT I : Measurements of Nuclear Data				
	1977	1978	1979	1980
<b>SUBPROJECT 1</b>				
Research Staff	41	41	41	41
Investments (KUA)	400	250	100	100
Total Running expenditure (KUA)	300	300	300	295
Expected Income (KUA)	0	0	0	0
<b>SUBPROJECT 2</b>				
Research Staff	15	15	15	15
Investments (KUA)	50	50	60	60
Total running expenditure (KUA)	100	100	100	120
Expected Income (KUA)	0	0	0	0
<b>Total Research Staff</b>	<b>56</b>	<b>56</b>	<b>56</b>	<b>56</b>
<b>Total Investments (KUA)</b>	<b>450</b>	<b>300</b>	<b>160</b>	<b>160</b>
<b>Total Running expenditure (KUA)</b>	<b>400</b>	<b>400</b>	<b>400</b>	<b>415</b>
<b>Total Expected Income (KUA)</b>	<b>0</b>	<b>0</b>	<b>0</b>	<b>0</b>

## 2. PROJECT : NUCLEAR REFERENCE MATERIALS AND TECHNIQUES

### 2.1. BACKGROUND

It is well known that analytical measurements can either be made on an absolute basis, or by reference to a standard having roughly the same form and composition as the unknown. In the former case it is necessary to measure each parameter involved with an accuracy much higher than the overall accuracy and consequently measurements are very time consuming and difficult. For this reason measurers often prefer to use the second approach, especially when an element of routine is involved.

Analytical measurements play an important role in the nuclear energy industry. For many of these measurements, the reference materials are already available on a commercial basis. However, there are cases requiring very special materials which are not already available and it is suggested that CBNM fill the role of providing and characterising these.

Apart from providing reference materials, the necessity to resolve differences between analyses on identical samples made by two or more laboratories, sometimes arises. When this happens between laboratories within the Community Countries it is proposed that, where possible, CBNM be invited to carry out an independent measurement to act as a reference. In both this role and that of providing nuclear reference materials, CBNM would be acting as a common nuclear standard laboratory in the European frame.

As nuclear technology advances so does the need for more accurate analytical measurements. Fortunately the techniques of analysis are also advancing quite rapidly and any future programme must be based on an ability to follow these advances and to contribute to some of the developments.

As the amount of nuclear fuel and generating capacity builds up in the Community, the demand for accurate analytical measurements will increase, and hence the demand for nuclear reference materials. These measurements will arise in several applications of which those of criticality, commercial transactions of nuclear fuel, environment, safeguards, and of nuclear data for reactor technology, are the most important.

Many of these reference materials are made from rare and expensive isotopes, which are presently only available from countries outside the Community, particularly the USA. It will be important to consider carefully whether this dependence from outside should continue and if not, how the Community could be more self supporting in this matter.

## 2.2. TECHNICAL DESCRIPTION

From a technical point of view this project can be divided into three parts, one concerned with the preparation and characterisation of nuclear reference materials to support analytical measurements, one concerned with the fabrication and characterisation of samples and targets for nuclear physics measurements, and one concerned with analytical measurements in support of safeguards.

### 2.2.1. Preparation and Characterisation of Nuclear Reference Materials to Support Analytical Measurements

Since any reference material must be very "user oriented", an important future action is to set up the mechanism for reviewing the requirements on a Community basis and for specifying the exact details of the material. It has been suggested that this task might be coordinated via an Ad Hoc Subgroup of the relevant ACMP.

Three main areas of work can presently be foreseen. These are : Preparation and characterisation of

- a. Reference samples in connection with the nuclear data measurement programme carried out in the Community, including CBNM itself. Since these samples are mostly in the form of thin foils, it is proposed to develop and apply methods of thin film analysis based on the use of nuclear and atomic radiations.
- b. Fissile reference materials to support analytical measurements made for the management of nuclear materials both in the context of safeguards and for the control of pollution. For safeguards in particular, very careful characterisation will be required in order to achieve the necessary accuracy. Chemical and physico-chemical techniques will be used to characterise for major and trace elements and mass or alpha spectrometry for isotopic composition, all of which are available at CBNM.
- c. Reference Materials, not necessarily radioactive, but which are required in the support of the nuclear industry. For example, a structural material with known quantities of nuclear poisons added would be useful in the analyses of irradiated structural components.

### 2.2.2. Manufacture and Characterisation of Special Nuclear Samples and Targets

Special nuclear targets, well characterised in composition and shape, are required for many nuclear physics experiments. Usually they are required in the form of very thin foils, but other shapes are sometimes required. This is a traditional activity of CBNM and is primarily carried out to support the nuclear data programme of CBNM and national laboratories of the Community. Requests also come from universities and other nuclear laboratories and over the years these institutions have become dependent on this specialised service.

Vacuum evaporation, electrospray and other techniques are used to deposit thin films of controlled thickness; rolling, canning, levitation melting and possibly other techniques are used to fabricate bulk samples into special shapes. Various metrological techniques including weighing and nuclear counting are used to characterise the samples.

### 2.2.3. Analytical Measurements in Support of Safeguards

The Direction Euratom Safeguards (DES), Luxembourg, is in charge of the nuclear material control according to chapter 7 of the Treaty of Rome. During the inspections of the fuel, samples are taken from the various nuclear installations within the Community and these must be analysed for fissile material content and composition (usually for uranium and plutonium) and the results compared with those declared by the operators. Various methods of analysis can be used, but the most common is the destructive one based on isotope dilution mass spectrometry. It is expected that the efficiency of working with mass spectrometers can be improved by the gradual automation of the measurement procedures. Apart from carrying out some of these analytical measurements, CBNM will also help DES in the collection and transportation of the samples, in possible interlaboratory tests and in evaluation of the results.

### 2.3. MANPOWER AND COSTS

PROGRAMME : Metre				
PROJECT 2 : Nuclear Reference Materials and Techniques				
	1977	1978	1979	1980
Total Research Staff	48	48	48	48
Total Investments (KUA)	300	285	300	300
Total Running expenditure (KUA)	300	300	300	315
Total Expected Income (KUA)	30	30	35	35

### 2.4. RELATIONS WITH EXTERNAL ORGANISATIONS

Contact has been maintained with ERDA (USA) for the supply of some rare basic materials, particularly the separated isotopes of fissile elements. Since the fabricated samples of these rare isotopes are often required by several laboratories, including CBNM, some coordination between them is necessary and CBNM, being the central laboratory, fulfills this role.

### 3. PROJECT : NON-NUCLEAR REFERENCE MATERIALS AND TECHNIQUES

As for Project 2, this project is concerned with reference materials and techniques, but on the much wider scale across the non-nuclear sector. It is concerned with JRC participation in the actual preparation of, and measurements on, reference materials within the Community - wide programme on non-nuclear reference materials and it is linked to the indirect action Reference Materials and Methods (BCR).

Some reference materials are available in the world on a commercial basis and some measuring methods have reached the status of reference (or standard) methods. In many fields of industry and applied research, however, there is a serious deficiency in these references and it is these gaps which the proposed programme sets out to fill.

The actual details of the programme are worked out after thorough reviews of the Community need and present availability, and after subsequent discussion with national experts. In most cases these discussions are arranged through specialist committees set up by the BCR Secretariat. The project is divided into two sub-projects, one concerned with Chemical references, and the other with Physical and Technological properties.

#### 3.1. SUB-PROJECT CHEMICAL PROPERTIES

##### 3.1.1. Background

This part of the programme is concerned with the provision of reference materials which form the base for analytical measurements by chemical means. The materials are either used to calibrate existing measuring apparatus or to verify methods of analysis.

The programme follows on sequentially from the present programmes at Ispra and Petten. In addition it is now proposed that the CBNM contributes by applying its expertise gained in the nuclear field.

The proposals conveniently divide into two parts, one for industrial applications and the other for environmental research. The latter is a relatively new field and therefore is one where there is a present lack of references.

##### 3.1.2. Technical Description of Projects

###### 3.1.2.1. Reference Materials for Industrial Needs

- a) RM's for ores, ores concentrates, impure and complex ores. This proposal is a continuation and the extension of that done in the previous pluriannual programme and includes galena, sphalerite, cassiterite and an oxide type copper ore. Three or four new zinc concentrates will be considered in order to enlarge the presently available Zn concentration range. Analytical methods so far employed will need to be improved to achieve better precision and accuracy.



Minor elements which represent a penalty for the producer and/or the smelter have to be determined both in the samples already certified and in the new samples. These RM's are urgently needed by the non-ferrous industry for application to commercial transactions.

b. High purity reagents.

The establishment of precise and accurate analytical data for trace elements by most of the microchemical techniques depends in part on the quality of the chemical reagents used through the analytical procedure. Consequently the availability of high grade acids ( $\text{HNO}_3$ ,  $\text{HCl}$ ,  $\text{HClO}_4$ ,  $\text{HF}$ ) with certified content of impurities is an essential requirement for analytical laboratories concerned with RM problems. Apart from the special methodology involved in their preparation, highly sophisticated analytical procedures for the certification will be required and the problem of storage will need to be studied.

c. RM's for fertilisers

The fertiliser industry is moving fast and the production and use of its products is constantly expanding. As a consequence analytical methods must be renewed to comply with the evolving technical problems and this in turn means that more RM's are required. As a first step of the project the certification of P and of a series of minor elements in superphosphate and natural phosphorite, currently used as base material for the production of fertilisers, is foreseen. This includes also the investigation of product stability over a period of several years and of homogeneity. On the basis of the results of this first step the project should be expanded to cover other commercially available fertilisers.

d. RM's for non-ferrous metals.

Non-ferrous metallurgy suffers from serious lack of suitable RM's especially for important materials such as Cu and Cu alloys, Pb and Pb alloys and Zr. However, some significant progress has been made in the preparation of alloys consisting of pure base materials and small, but accurately known added traces (down to the ppm level) using the high frequency levitation technique. It is proposed to continue with this development and to provide help in sampling and shaping and distributing samples to laboratories for analysis. Where appropriate, the Ispra and Geel Establishments will also participate in the analyses.

e. RM's for non metals in non-ferrous metals.

The sensitive influence of gas content on metallurgical and technological properties of metals is now recognised, and analytical procedures for determining the gas have been developed. However, as yet suitable RM's are very scarce. The situation is still more complicated where refractory metals (Ti, W, Nb, Zr, etc.), whose technological importance is presently growing, are considered because reliable analytical methods must first be investigated and set up. The participation in a series of round robins for  $\text{O}_2$  and  $\text{N}_2$  determination in these materials is expected, the selection of the materials to be investigated on a priority scheme being performed by a multinational working party.

## f. RM's for coal and coke.

It is proposed to determine for certification purposes a series of trace elements in coal and coke with a special reference to those of primary significance for pollution problems (Cd, Pb, Hg, S, etc.) and the characterisation of coal from a chemical point of view. The development of special trace analysis methods is necessary to overcome the difficulties associated with the matrix nature and the very low concentration level of the elements sought.

## g. RM's for surface films.

Preparation and characterisation of surface films is proposed for use as references in the analysis of surfaces. Besides the many research applications, there is a growing demand for instruments and methods for surface analysis in industrial use, e. g. manufacture of electronic components. Reference materials likely to be needed in the near future will be thin foils of pure metals, alloys of two or more constituents, pure and mixed oxides, semiconductor layers.

## h. RM's for general organic analysis.

The organic laboratory of JRC Petten will in particular take part in round-robin analyses and intercomparison studies which will be organised by BCR in the organic sector (e. g.) polymers, petroleum products, cosmetics). In turn, these activities may result in accommodating further needs for reference materials in the field of organic products.

3. 1. 2. 2. RM's for environmental pollution studies

Pollution research is a rather new technological area which presents acute needs of RM's for a broad variety of matrices. In the Community legislative measures are being taken to limit or exclude potentially hazardous or toxic substances from commercial products and the environment. For the analytical control of such directives it is essential to make available suitable reference materials.

The following tasks are foreseen :

## a) RM's for atmospheric aerosols.

The preparation of a large batch of atmospheric particulate material being under way, the participation in a round robin for certification purposes is scheduled for the beginning of the pluriannual programme. The extension of the project to other similar samples is subject to the decision of the specialised working group.

## b) RM's for terrestrial and aquatic plants.

Two terrestrial plants highly differentiated in their matrix and 4 aquatic plants with varying trace element contents will be prepared, analysed and distributed to a series of well experienced laboratories for certification purposes.

The preparation will include the study of all the steps which ensure that a homogeneous product is formed. This project is expected to be initiated in the course of 1976 and to be terminated in 1980.

c. RM's for soils.

3 to 4 samples will be chosen on the basis of how representative and useful they are as RM's. Before carrying out the analytical work, preparation studies and homogeneity tests must be performed. The project could be terminated in 3 to 4 years and could include the preparation and analysis of 2 sediment and/or 2 sludge samples.

d. RM's for water samples.

The technical content of this project which is concerned with the preparation and characterization of an RM for waste water is presently under discussion by a specialised working party. Apart from the analytical difficulties connected with the nature of the sample concerned, it must be stressed that the stability and preservability of the sample will represent the fundamental parameters to be investigated.

e. RM's for food samples.

Three readily available commercial products, milk powder, potato powder, will be analysed for traces of toxic elements (Hg, Se, Pb, Cd, etc.). The most difficult problems will consist in the establishment of accurate and precise analytical methods.

f. RM's for food packages.

It is proposed that the organic laboratory of JRC Petten provides reference packing materials for the migration control of hazardous additives (plasticizers, stabilisers, antioxidants, colorants, etc.) into foodstuffs. In special cases these reference materials may be labelled with  $^{14}\text{C}$  in order to facilitate the quantitative trace analysis of harmful additive RM's for other organic materials. For the control of hazardous organic substances, such as for example polycyclic aromatic hydrocarbons, in the environment and in other products, it is proposed to provide a set of pure reference materials, which again, if need be, may include  $^{14}\text{C}$  labelled compounds.

### 3.2. SUB-PROJECT PHYSICAL AND TECHNOLOGICAL PROPERTIES

#### 3.2.1. Background

As technology advances, so the need arises for more precise knowledge of the properties of materials. At the same time novel materials are developed and this in turn usually means, that new methods of measuring the properties are required.

Obviously the whole field of physical and technological properties is vast and it is impossible to describe in general terms the present state of knowledge. However, for some specific fields, which are particularly suited to the expertise of the Ispra Establishment, thorough reviews have been carried out with the conclusion that further work is urgent and necessary. Some part of the proposed work is a continuation of work presently going on, but some are entirely new actions.

However, it should be noted that in the past years a large investment has been made which now would permit the execution of the described activities without large capital expenditure. Also the necessary skill and expertise are present in the JRC.

### 3.2.2. Technical Description of the Sub-Project

This sub-project is subdivided into two main parts; physical properties and measurements, and technological properties and measurements.

#### 3.2.2.1. Physical Properties and Measurements

##### a. Preparation of Viscosity Reference Oil

Viscosity reference oils have been supplied by a few institutes, but the errors made in establishing viscosity scales should now be tested. It is important to know these errors and to try to arrive at a unique viscosity scale for Europe.

It is now proposed to characterise a viscosity reference oil by making measurements with an absolute viscometer based on Couette's ideas in 1936. In order to make measurements at a series of temperatures (previous measurements have been restricted to 20°C) the apparatus will be built into a heat pipe which is already available at Ispra.

##### b. Thermal Properties and Measurements

###### (i) Heat pipe thermostats.

In reference measurements where temperature precision and stability are the major criteria, the heat pipe, so modified as to make it an isothermal chamber of controllable temperature, is a valuable tool. Its applications range from viscosity measurements to enzyme production, via reference points on the temperature scale and black body emission. The following programme of work is proposed.

- study of the basic phenomena which limit the performance of heat pipe thermostats (gas solution and diffusion, impurities, pressure, control) ;
- the development of prototype heat pipe thermostats for covering the temperature region from room temperature up to about 2400°C and investigation of their temperature homogeneity, stability and reproducibility.

**(ii) Calibration of temperature fluctuation probes.**

This proposal concerns the development of a versatile and generally acceptable calibration method, in order to determine the transfer function of probes for temperature fluctuation measurements. The heat transfer between flowing medium and probe influences the probe's response lag.

The method to be developed will be a modified plunge test in which the probe is plunged into a medium flowing at a well defined velocity and at an equally well defined temperature. The signal emitted by the probe due to this temperature step is analysed automatically to supply the transfer function.

**(iii) Measurement Procedure for Temperature Gradients in Flowing Media.**

The fact that a single fixed probe can "see" the lateral temperature distribution in a certain range over the flow cross section, is explained by the statistical transport properties of the turbulent flow. From the probe's signal the lateral temperature profile can be constructed by analysing the amplitude distribution of the measured temperature noise. The procedure needs, however, a scaling factor which takes into consideration the turbulent lateral eddy transport and it is proposed to study this scaling factor for different flow geometries and conditions. The applicability of this procedure to two-dimensional profiles will also be ascertained.

**(iv) Melting and Latent Heats of Fusion.**

Digital thermometers (thermistors) are now being regularly used in hospitals. Their periodic control and calibration is judged to be essential. To assist these calibrations it is proposed to measure the melting points and latent heats of fusion of some specially selected substances using an adiabatic calorimeter which has been built at Ispra.

**(v) Total hemispherical emissivity for thermal radiation.**

It is proposed to measure this quantity for some important materials such as steel and glass. The feasibility of a reliable method has already been studied at Ispra.

**(vi) Thermal conductivity.**

References for thermal conductivities of modern materials are not available. In the case of solids it is therefore proposed to develop further a transient method of measurement on low conductivity materials up to temperatures of about 1400°C, and compare the results obtained with a standard steady state method. Studies will be made on fibrous materials such as glass fibre and the influence of fibre orientation. The variation of conductivity of concrete with water content of the concrete will also be studied.

Reference measurements will also be made on some liquids, the first one being toluene.

### 3.2.2.2. Technological Properties and Measurements

#### a. Ultra-sonics

- Characterisation of equipment for non-destructive testing. Fault detection by ultra-sonic detection is a very important method of non-destructive testing but improvements in its use through proper characterisation of the equipment is necessary. It is proposed to determine the characteristics of immersion, contact and other special transducers, as defined by a specialists group. In addition, it is proposed to produce material with artificial standard defects which can be used to calibrate ultra-sonic equipment. The artificial defects are produced by machining, punching and electro discharge techniques in specimens of stainless steel and other alloys. Round robin tests will then be organised via BCR.
  
- Characterisation of equipment used in medicine. As with the industrial application of ultrasonics, characterisation of equipment used in medicine is also very important. It is proposed that work be carried out to try to simplify the apparatus which is used and to make detailed characterisation of the various components used in the equipment, the emitters and receivers, electronic and mechanical aspects. In addition, it is proposed to define the criteria for optimal use of equipment in each particular case of diagnosis and to prepare and define references allowing easy regulation of the apparatus.

#### b. Impact Toughness

Many commercial conflicts between buyer and supplier arise due to wide divergencies in the results of test measurements, mainly due to important instrument defects and lack of conformity to existing written standards. Work on the measurement of impact toughness, and the reference samples to be used is therefore suggested.

It is proposed to :

- study the effects of composition, the thermal treatment and the machining and finishing of impact specimen on the measurement of toughness.
- distinguish between the dispersion in results due to the machine and the dispersion due to the specimen by the application of high quality test instrumentation.

#### c. Tribology

Tribology is the study of friction, i. e. wear and tear. Many laboratories measure it, but there are many errors and relative discrepancies. So the preparation of reference friction couples and an in-depth comparative study of methods between laboratories is a very urgent need.

A complex set up of equipment exists at Ispra to carry out measurements of friction under different conditions. Using this equipment it is proposed to make studies of friction under normal conditions without lubricant, at high temperature, under vacuum and to study friction of plastics and composite materials.

In the frame of BCR Ispra is presently involved with the preparation and organisation of an intercomparison programme involving about 10 European laboratories and after completion of this it is proposed to circulate a specially made tribotesting device to the participating laboratories.

Other items of proposed study include ultrasonic emission due to friction, prompt thermal detection of a seizure, and correlation between internal and external friction.

3.3. MANPOWER AND COSTS

PROGRAMME : Metre				
PROJECT 3 : Non-Nuclear Reference Materials				
	1977	1978	1979	1980
<b>SUBPROJECT 1</b>				
Research Staff	26	26	26	26
Investments (KUA)	50	100	100	125
Total Running expenditure (KUA)	145	145	145	145
Expected Income (KUA)	0	0	0	0
<b>SUBPROJECT 2</b>				
Research Staff	32	32	32	32
Investments (KUA)	150	150	150	115
Total Running expenditure (KUA)	240	240	250	250
Expected Income (KUA)	0	0	0	0
<b>Total Research Staff</b>	<b>58</b>	<b>58</b>	<b>58</b>	<b>58</b>
<b>Total Investments (KUA)</b>	<b>200</b>	<b>250</b>	<b>250</b>	<b>240</b>
<b>Total Running expenditure (KUA)</b>	<b>385</b>	<b>385</b>	<b>395</b>	<b>395</b>
<b>Total Expected Income (KUA)</b>	<b>0</b>	<b>0</b>	<b>0</b>	<b>0</b>



#### 4. PROJECT : SCIENTIFIC SUPPORT TO THE SERVICES OF THE COMMISSION

##### 4.1. BACKGROUND

Since the JRC laboratories are the only scientific laboratories belonging to the Commission, it is natural to expect that from time to time the expertise of these laboratories will be used directly by the various Commission services. This is especially true in the field of measurements and references, both nuclear and non-nuclear, since these activities cover a wide range of applications.

These activities are motivated by the broad interest of the General Directorates, but are in themselves restricted to areas where the specific expertise and facilities of the JRC laboratories can be used. The areas concerned are technical barriers to trade, common customs tariff, biology, energy conservation and environment research. Since the activities will be in the measurement and reference field, some will also be indirectly helpful for the development of the BCR programme.

##### 4.2. TECHNICAL DESCRIPTION OF THE PROJECTS

###### a. Development and application of reference analytical methods for pesticides residues in foodstuffs. (ISPRA)

Cooperative standards for the evaluation of analytical methods for organophosphorus and organochlorine pesticides in fruits and vegetables will be studied and the selected methods will be applied to organochlorine pesticides in foodstuffs of animal origin. These methods should be recommended for use by EEC as a basis for the establishment of Community directives. Taking into account the large variety of products to be considered, this is a very long term project.

###### b. Release of toxic elements from ceramic objects. (ISPRA)

Community directives aimed at the protection of the consumer from the toxic release of Pb and Cd from ceramic kitchenware and tableware will be established. As a first approach, the cold extraction of toxic element by an unanimously agreed test will be studied. A study of Pb release at temperatures above room temperature, will be concluded in order to establish a correlation factor between hot and cold extraction. The research will be concluded tentatively in 1977 as far as Pb is concerned, but is likely to be extended to Cd, Co and Se release.

###### c. Reference methods for fertilisers. (ISPRA)

Analytical methods applied in the various countries of the European Communities, for P and N determination in fertilisers will be evaluated and compared in order to select the ones to be used as EEC reference methods. Taking into account that new products are often introduced and the fact that other parameters (i. e. trace elements) are likely to be considered, the project will cover the entire 4 year programme.

- d. **Cosmetics, polymers and petroleum products. (PETTEN)**  
For the application of council directives for trade in organic chemical products or as a consequence of decisions concerning the Common Customs Tariff, the need often arises for experimental analytical work in the organics field. An example is the project for establishing a list of substances to be allowed in cosmetic products. This project requires the control and verification of well defined analytical procedures and may include in some instances the provision of reference substances.  
Similar analytical work is regularly requested by the Administration of the Common Customs Tariff for establishing recognised methods of differentiation of organic chemical products according to tariff class, especially for the C. C. T. Chapters 27 (Petroleum and related products); 29 (Organic products) and 39 (Polymers).
- e. **Expertise and secretariat support. (ISPRA)**  
An expertise and/or secretariat support to different EEC working groups (biodegradability of surfactants, analytical methods for cosmetics, harmful substances, etc.) can be foreseen as a continuation of present activity. This programme will be subject to be enlarged or compressed depending on the needs expressed by the General Directorates concerned.

4. 3. MANPOWER AND COSTS

PROGRAMME : Metre				
PROJECT 4 : Scientific Support to Commission Services				
	1977	1978	1979	1980
Total Research Staff	9	9	9	9
Total Investments (KUA)	70	—	—	—
Total Running expenditure (KUA)	30	30	30	40
Total Expected Income (KUA)	0	0	0	0

## 5. PROJECT: SCIENTIFIC SUPPORT TO THE SECRETARIAT OF BCR

### 5.1. BACKGROUND

The proper functioning of the BCR relies on a large participation of national bodies as well as the JRC in all phases of the action. The problem of coordination and ensuring proper information flow is immense as is also the problem of obtaining a consensus of the results, since local habits are sometimes very strong. Since the whole action covers many fields of science it is clear that for efficient working the BCR secretariat needs to call on part time help of scientific specialists, who will be chosen within the JRC when the relevant competence exists.

It is therefore proposed that the JRC offers this help in the following ways.

### 5.2. TECHNICAL DESCRIPTION

#### a) Assistance of specialists.

Since 1972 a large number of national experts groups have been created with the aim of defining the actions to be undertaken in their respective domains (methodology studies, elaboration of reference materials, selection of reference methods). A large number of JRC agents have ensured the scientific secretariat of these groups, and so contributed to the definition of European actions and to the harmonious integration of the laboratory activities in a coherent context. Therefore we propose to continue and stretch to other domains in which we are competent.

#### b) Inquiry.

In 1970 the JRC carried out a general inquiry on the European needs for reference materials and this formed the basis of the present BCR type actions. A new inquiry might take place during the period 1977/80.

#### c) Information.

This activity involves the following items:

Guide-Book of relevant addresses.

The guide-book of addresses relevant to the field of reference materials was made in 1972 and will be updated from time to time.

Computerised data-bank.

By the end of 1976 the data bank on reference materials and high purity substances will contain from 15 to 20 000 articles (final state about 30 000 articles). Its functioning in "batch" mode and "teleprocessing" will give the possibility to answer to the questions of the different laboratories of the Community and of the BCR secretariat, concerning these materials.

### Information Bulletin

The JRC proposes to participate in the publication of a bulletin which will include

- short information on the activities carried out in the BCR domain (direct and indirect action)
- information about the outcome of BCR domain
- summaries of publications concerning reference materials
- annual index of selected references
- synthesized documents elaborated in the BCR frame

The screening of literature will require the participation of a certain number of JRC specialists (Geel, Ispra, Petten) and from outside (contracts).

It is anticipated that 4000 copies will be needed.

### Applied statistics

The indispensable tool for BCR activities has to be developed and applied in different fields. It is proposed to concentrate effort on:

- preparation of intercomparison measurement campaigns
- analysis of results of measurements in view of the certification of and/or agreement of candidate reference methods.
- sampling problems
- intercomparison studies and selection of the most appropriate statistical methods
- more fundamental studies of some concepts such as sensitivity limit, detection limit
- courses for the Commission's specialists engaged in the BCR action and needing statistics for their work.

### 5.3. MANPOWER AND COSTS

PROGRAMME : Metre				
PROJECT 5 : Scientific Support to BCR Secretariat				
	1977	1978	1979	1980
Total Research Staff	10	10	10	10
Total Investments (KUA)	0	0	0	0
Total Running expenditure (KUA)	100	100	100	100
Total Expected Income (KUA)	0	0	0	0

ADVISORY COMMITTEE  
ON PROGRAMME MANAGEMENT

-----  
"CENTRAL BUREAU FOR  
NUCLEAR MEASUREMENTS"

DRAFT - OPINION

of the ACPM-CBNM on the CBNM programme proposals 1977 - 1980

The Advisory Committee on Programme Management (ACPM) of the Central Bureau for Nuclear Measurements examined during the meeting of October 1-2, 1975 and January 14-15, 1976, the CBNM proposals for the 1977 - 1980 programme.

The advice of the ACPM has mainly been based on the document CCMGP-CBNM 39/75 "Programme for CBNM 1977 - 1980". This document is identical with the version sent to the Director General of JRC.

The ACPM obtained also detailed information on the proposed budget and staff distribution. A thorough discussion was held for all proposed investments items costing more than 100.000 ua.

During the course of the meeting on January 15, 1976 the ACPM gave the following advice:

1. The ACPM was satisfied that in general the programme proposals were relevant both to the needs of the Community and to the statutory task. The continuation of measurement and evaluation of nuclear data, and the preparation and characterization of materials for nuclear measurements is seen to be a useful and collective basic programme to support nuclear reactor design, fuel management, nuclear medicine and environmental problems.
2. The ACPM was satisfied of the relevance and importance of the proposed programme on Nuclear Data Measurements, as submitted to the Director General of JRC.

It wishes to emphasize, however, that the selection of the individual components of the programme must be strongly influenced by the needs of the Community, as made manifest both in the various national request lists of the Community, and by continuous close interaction with its scientists.

The programme points

- accurate determination of neutron data requested for most important actinides
- measurements of cross sections for structural materials
- determination of capture data ( cross sections and resonance parameters) for important fission products

- determination and evaluation of neutron data standards were considered of equal importance.

In addition it was considered that:

- work on thermal cross sections should be continued by CBNM for the next four years period, and that equipment be retained for that purpose
- work for CTR data will increase in importance and work on this topic would be appropriate to CBNM if the needs develop.

The ACPM noted that the improved linear accelerator is in principle capable in supporting many more first line staff than are likely to be available, but that great care must be taken to maintain a proper balance between data acquisition and analysis.

3. After examining in detail the requirement of the Community for non neutron nuclear data (compiled into a request list by CBNM) the ACPM accepted the proposals in this field with certain modifications.

The ACPM agreed that CBNM should

- a) continue to make full use of its expertise for the determination of nuclear and associated atomic data
- b) collaborate with other establishments active in the field of non-neutron nuclear data evaluations.

Further the ACPM regarded the staff resources devoted to non-neutron nuclear data to be adequate, but noted that these would have to be increased if charged particle reactions are to be included in the programme.

4. The ACPM noted that approximately seven staff members are engaged on non-nuclear reference materials and that the ACPM BCR had recently supported a programme of this magnitude to be carried out at CBNM on these topics.

The ACPM recommends that these activities are to be continued at no more than the above mentioned level in the expectation that the programme may develop to a fully supported one.

5. The ACPM considered that the proposals for nuclear reference materials methods and measurements are a justified continuation of the support given by the CBNM to nuclear measurements, to the management of the nuclear fuel cycle and to the nuclear industry.
6. The ACPM expected an increase in the requirements of the "Analytical Measurements in Support of Community Safeguards". If these expectations are borne out any further extension of the services supplied by CBNM should be solved without increase of the staff, allocated to this programme point.

7. The ACPM accepted that the manufacture and characterization of special nuclear samples and targets are of high interest to the Community. It suggested that the CBNM should stimulate the multiple use (by different laboratories) of complicated and expensive samples and targets.
8. The ACPM considered that proposed limited programme "Application of Nuclear Measurements to Commission Problems" a normal task of a JRC laboratory. The proposed support will be based on existing CBNM techniques.
9. The ACPM examined the CBNM proposals for purchase of items costing more than 100.000 ua and of these proposals the ACPM supported in principle the items listed in Appendix, subject to individual re-examination in detail when the cases are brought forward.
10. The ACPM welcomes the proposals to offer contracts for work in various areas in the nuclear field, noted the discrepancy which already exists in the Commission in respect of such funding for nuclear and non-nuclear reference materials, and recommends the Director of CBNM to seek methods of funding such contracts.
11. The ACPM recommend that the overall budget for the period 1977 - 1980 shall be effectively the same as the budget for the previous period 1973 - 1976 (adaptation of this budget to the increasing costs).
12. The ACPM is concerned about the increasing proportion of the total budget which is taken by staff expenditure (based on normal career development and general salary increases), because this implies that, within a constant overall budget in real terms, an ever decreasing sum is available for research expenditure and technical support.



APPENDIX

## List of Supported Proposals

	KUA
Modernisation of Data Acquisition Equipment	250
X-Ray Fluorescence Spectrometer	150
Extension of Linac Building	200
Replacement of Tandem Mass Spectrometer	150
Extension of Mass Spectrometry Building	130
Computer Terminal System	170
Replacement of Gas Mass Spectrometer	150
	<hr/>
TOTAL	1200
	<hr/>

ADVISORY COMMITTEE  
ON PROGRAMME MANAGEMENT

-----  
B C R

D R A F T

OPINION of the ACPM - BCR  
on the Programme Proposals 1977 - 1980 for the BCR direct  
action, which will be executed by JRC

---

1. On request of the CCG the ACPM-BCR examined during its meetings of 28 and 29 January 1976 the programme proposals for 1977-1980 of the non-nuclear part of the direct action METRE \*).
2. The Committee noted the statement of the representative of the Commission, indicating that
  - 2.1. the document "Proposals for the next pluriannual programme 1977-1980 - METRE - 1st part, non nuclear activities, dated 8 January 1976 and carrying the reference HL of 00800/2/76", consists of a catalogue of project proposals.
  - 2.2. the Director General of the JRC takes the final decision on which proposals will be submitted to the Commission and also to decide the corresponding requirements for staff and budget.
  - 2.3. the Director General attaches great importance to the advice of the ACPM-BCR concerning the value of the proposed projects and their respective priorities.
3. The examination of the proposals in the above mentioned document led the ACPM to classify the projects into those of first and second priority and to advise the allocated resources, both staff and budget. The results of this classification are given in a table (see appendix).
4. The ACPM gave very positive support for the first priority actions with the following reservations and observations:
  - 4.1. each time when JRC undertakes an activity to support the service of the Commission, the possibility of charging the appropriate Directorate General for the expenses connected with the activity should be examined.
  - 4.2. one of the delegations objected to the allocation of substantial credits for contracts. This delegation advised that the JRC should only offer contracts to support its programme in special cases and for relatively small amounts.

-----  
\*) METRE = Measurements, Standards and Reference Techniques

- 4.3. the activities in the field of environment, which are part of action III, should not be undertaken without formal agreement of the responsible services of the Commission for "environment and protection of consumers".
- 4.4. a specialist opinion should be obtained on the action IV 1 b (melting points and latent heat fusion) before starting the action.
- 4.5. the action IV 5 (total hemispherical emissivity) should be undertaken in collaboration with the Directorate General responsible to the Commission for the execution of the research programme on energy, and also eventually with advisory groups of the Community, working in this field.
- 4.6. on action V 2 (ultrasonics in medicine) the CREST medical sub-committee should be invited to comment before starting the action.
5. The ACPM advised that resources (staff and budget) should only be allocated to items of first priority. However, on insistence by the Director General that the METRE type activities should be increased in the frame of a future JRC programme, second priority items could be added. One of the delegations reserved its position on the level of staff and budget allocated to the items of second priority.
6. The ACPM expressed the opinion that in any case it would be unjustified to allocate to the non-nuclear part of direct action METRE, more resources than is indicated in the table of the appendix.
7. In all cases, where interest of one or more member countries in the subject of a direct action exist, the possibility has to be examined to complement the direct action with indirect actions on the same subject.

A P P E N D I X

Advice of ACPM-BCR on the programme proposals for JRC 1977-1980 in the field of BCR

PROJECTS	Research-men		Budget 1977-1980 for equipment and for contracts. Prices 1.1.77 in 1000 UA		Budget 1977-1980 for contracts. Prices 1.1.77 in 1000 UA		
	1st priority	2nd priority	1st priority	2nd priority	1st priority	2nd priority	
<u>I Scient. and techn. support to BCR secretariat</u>							
Geel	1,5	-	-	-	-	-	
Ispra	8	+ 2	312	-	40	-	
Petten	1	-	-	-	-	-	
<u>II Scient. and techn. support to the Commission</u>							
Ispra	5	-	60	-	-	-	
Petten	4	-	140	-	-	-	
<u>III Ref. Mat. and chemical analysis</u>							
Geel 1. Preparation and shaping of RM	5,5	-	290	-	-	-	
2. Prepar. and charact. of surfaces		-	-	-	-	-	
3. RM - ores - gas in metals		-	-	-	-	-	
Ispra 4. RM-ores	10	+ 4	125	+ 50	40	-	
5. High purity reagents		-	-	-	-	-	
6. RM for fertilizers		-	-	-	-	-	
7. RM for non ferrous metals		-	-	-	-	-	
8. RM for metals in non ferrous metals	8	-	400	-	-	-	
9. RM for coal and coke		-	-	-	-	-	
10. RM for environment		-	-	-	-	-	
Petten 11. RM - organic chemistry	3	+ 1	40	-	-	-	
<u>IV Ref. Mat. and Physical Properties (Ispra)</u>							
1a. Viscosity reference oils		4,1	+ 1,9	120	-	60	-
b. Melting points and latent heat fusion			-	-	-	-	-
2. Heat pipe thermostats		1,5	-	15	-	-	-
3. Calibration of temp. fluctuation probes			-	20	-	-	-
4. Measur. procedure for temperature gradients	-		60	-	-	-	
5. Total hemispherical emissivity	4,6	-	91	-	-	-	
6. Thermal conductivity		-	-	-	-	-	
<u>V Ref. Mat. and Technological Properties (Ispra)</u>							
1. Artif. ref. defects charact. of ultrasonic gages	4,3	+ 2,7	100	+ 50	100	+ 50	
2. Ultrasonics in medicine	2	+ 3	160	+ 240	200	3200	
3. Impact toughness	4	-	88	-	-	-	
4. Tribology Ref. Methods	4,6	-	100	-	60	-	
<b>TOTAL</b>	<b>73,1</b>	<b>+ 14,6</b>	<b>2121</b>	<b>+ 340</b>	<b>500</b>	<b>+250</b>	
<b>Total 1st and 2nd priority</b>	<b>87,7</b>		<b>2461</b>		<b>750</b>		

10. SERVICE AND SUPPORT ACTIVITIES

10.1 HFR (HIGH FLUX REACTOR)

10.2 INFORMATICS

10.3 TRAINING AND EDUCATION

10.4 SAFEGUARDS

10.5 TECHNICAL EVALUATIONS IN SUPPORT TO THE COMMISSION

PROGRAMME :  
S E R V I C E   A N D   S U P P O R T   A C T I V I T I E S

T A B L E   O F   C O N T E N T S

INTRODUCTION

1. PROJECT : H.F.R. (HIGH FLUX REACTOR)

1.1. BACKGROUND

1.2. TECHNICAL DESCRIPTION

1.3. MANPOWER AND COSTS

2. PROJECT : INFOMATICS

2.1. SUB PROJECT : EUROPEAN INFORMATICS NETWORK (COST 11)

2.1.1. Background

2.1.2. Technical description

2.1.3. Planning

2.1.4. Manpower and costs

2.2. SUBPROJECT : EUROPEAN COMPUTER PROGRAM INSTITUTE (EUROCOPI)

2.2.1. Background

2.2.2. Technical description

2.2.2.1. Program Information Service

2.2.2.2. Program Distribution Service

2.2.2.3. Advertising, Administration

2.2.3. Planning

2.2.4. Manpower and costs

2.2.5. Associations with external organizations

2.3. SUBPROJECT : EUROPEAN SHIELDING INFORMATION SERVICE (ESIS)

2.3.1. Background

2.3.2. Technical description

2.3.2.1. Nuclear data for Shielding

2.3.2.2. Assessment of Shielding programs

2.3.2.3. Shielding Experiments

2.3.2.4. Technical Support

2.3.2.5. Shielding data Bank (SDB)

2.3.2.6. Information Dissemination

2.3.3. Planning

2.3.4. Manpower and costs

2.3.5. Connections with "indirect actions"

2.3.6. Associations with External Organizations

2.4. SUBPROJECT : METHODOLOGICAL STUDIES (SOFTWARE ENGINEERING,  
AUTOMATIC DOCUMENTATION)

2.4.1. Background

2.4.2. Technical description

2.4.2.1. Software Engineering

2.4.2.2. Automatic Documentation - (Connection with EURONET)

2.4.3. Manpower and costs

2.4.4. Contacts with external organizations

3. PROJECT : TRAINING AND EDUCATION

3.1. BACKGROUND

3.2. TECHNICAL DESCRIPTION

3.3. MANPOWER AND COSTS

4. PROJECT : SAFEGUARDS

4.1. BACKGROUND

4.2. TECHNICAL DESCRIPTION

4.2.1. Control systems

4.2.2. Measurements Techniques

4.2.3. Surveillance Techniques

4.2.4. Special problems in Reprocessing Plants

4.3. MANPOWER AND COSTS

5. PROJECT : TECHNICAL EVALUATIONS IN SUPPORT TO THE COMMISSION

5.1. BACKGROUND

5.2. TECHNICAL DESCRIPTION

5.2.1. Analysis of the Communitie's energy system

5.2.2. Evaluation of advanced applications of informatics

5.2.3. System studies on renewable and non renewable resources

5.2.4. Studies on pollution problems

5.3. PLANNING

5.4. MANPOWER AND COSTS



## APPENDIX E-I-10

## PROGRAMME

S E R V I C E A N D S U P P O R T A C T I V I T I E SINTRODUCTION

The preparation of the multiannual programme has concentrated on important self-consistent projects which absorb most of the available man-power and credits.

Nevertheless, it is recognised that the J.R.C. should continue to provide, as a limited part of its overall activity, services relevant to its competence to both external bodies within the Community and to other branches of the Commission.

These activities should satisfy one or more of the following criteria :

- a) the activities should provide a public service to a large number of institutes, firms etc throughout the member countries.
- b) the activities should constitute a specific support to the activities of other services of the Commission.
- c) the activities should be executed as part of an international effort, and be regulated by specific agreements between the Commission and the relevant national or international organisation.

Having now defined the criteria, the fulfilment of one or more of which was the guide to choosing an activity and classifying it into this programme, "Service and Support Activities" , the following list of projects catalogues the retained activities in a more disciplined and precise form.

PROJECT 1 : H.F.R. (HIGH FLUX REACTOR)

PROJECT 2 : INFORMATICS

SUBPROJECT 2.1. : EUROPEAN INFORMATICS NETWORK (COST 11)

SUBPROJECT 2.2. : EUROCOPI (European Computer Program Institute)

SUBPROJECT 2.3. : ESIS (European Shielding Information Service)

SUBPROJECT 2.4. : METHODOLOGICAL STUDIES (Software Engineering,  
Automatic documentation)

PROJECT 3 : TRAINING AND EDUCATION

PROJECT 4 : SAFEGUARDS

PROJECT 5 : TECHNICAL EVALUATIONS IN SUPPORT TO THE COMMISSION

- The table below shows in which way the above criteria are fulfilled by each activity :

ACTIVITIES CRITERIA	1	2.1	2.2	2.3	2.4	3	4	5
a)	X		X	X		X		
b)		X	X	X	X	X	X	X
c)		X						

The operation of the H.F.R. (High Flux Reactor) in Petten can be considered as a service activity, since its irradiation capacity is used by the large technological research centres and the industry of the participating countries, as well as the JRC Establishments of Ispra, Karlsruhe and Petten. The successful operation and exploitation of the reactor under the current programme, confirmed by the relevant Advisory Committee for Programme Management (ACPM) justify the continuation of the entire activity.

In the project "Informatics" are grouped those activities on which efforts should be concentrated in order to make contributions to the Commission policy in this field<sup>x</sup> and to promote the use of advanced and efficient systems for the automatic collection /treatment/ dissemination of information. With respect to the previous actions of the JRC in this field it is proposed to abandon some of them and to retain only four essential items :

xRef.:Community Policy for Data-Processing- COM (75) 467 final

- the justification for the continuation of the European Informatics Network, COST 11 project, lies not only in the continued participation of the Commission in a COST agreement but also in the great technical interest of such a project (efficient communication between computers geographically disseminated).
- Eurocopi is being recognized by the relevant ACPM (Advisory Committee for Programme Management) to be an important and popular service since it fulfills an essential function in disseminating knowledge of computer programs and applications throughout the Community.

During the next multiannual programme an effort will be made to recover an increasing part of the cost. The target is to recover the whole of the operational expenditure by 1980.

- ESIS has so far been one of the three actions of the "Objective Information Analysis Services".  
The ACPM has supported the pursuing of the ESIS activity in the future programme in view of its usefulness to those involved in shielding work.
- The methodological studies concern the software engineering and the automatic documentation.

As far as software engineering is concerned, an activity of the JRC in this field should be an important support to the Commission services in charge of the Informatics Policy. Besides, the importance of participating in national efforts on special topics was recognized by the ACPM.

The activity concerning automatic documentation is the continuation of the work performed in the current programme period, but increasingly centred around pilot applications. A very strong connection with the Directorate General "Scientific and Technical Information and Information Management" (GD XIII) is foreseen specially in the frame of its EURONET project (European Network for Scientific and Technical Information and Documentation).

The project "Training and Education" is an activity co-ordinated with the action of the General Directorate Research, Science and Education (GD XII) in the scientific and educational field. The importance and interest of training people is generally recognized. The aid to developing countries can in particular have recourse to this activity. As in the case of Eurocopi, recovery of an increasing part of the expenditure is expected.

The work on Safeguards is specifically requested by General Directorate Energy (GD XVII), Safeguards Directorate. It is a part of the technical support which the JRC gives to other services of the Commission.

The project "Technical Evaluations in Support to the Commission", is an activity whereby the JRC provides technical and scientific expertise upon request to the other services of the Commission. This project contributes a permanent support and is entirely funded by the General Budget of the Commission (chap. 26).

## SUMMARY OF MANPOWER AND COSTS

PROGRAMME : SERVICE AND SUPPORT ACTIVITIES						
	Research staff (per year)	Investments (M.U.A.)	Total running expenditures (M.U.A.)	Resources (M.U.A.)	Budget required (M.U.A.)	Expected Income (M.U.A.)
<u>PROJECT 1 - HFR (HIGH FLUX REACTOR)</u>	42	0.725	22.760	0.400	23.085	-
<u>PROJECT 2 - INFORMATICS</u>						
<u>SUBPROJECT 1 : EUROPEAN INFORMATICS NETWORK (COST 11)</u>	5	0.220	1.120	-	1.340	-
<u>SUBPROJECT 2 : EUROPEAN COMPUTER PROGRAM INSTITUTE (EUROCOPI)</u>	12	-	0.860	0.190	0.670	0.190
<u>SUBPROJECT 3 : EUROPEAN SHIELDING INFORMATION SERVICE (ESIS)</u>	13	0.200	0.420	-	0.620	-
<u>SUBPROJECT 4 : METHODOLOGICAL STUDIES (SOFTWARE ENGINEERING, AUTOMATIC DOCUMENTATION)</u>	7	-	0.470	-	0.470	-
<u>PROJECT 3 - TRAINING AND EDUCATION</u>	5	-	0.240	0.120	0.120	0.040
<u>PROJECT 4 - SAFEGUARDS</u>	19	-	0.600	0.400	0.200	0.020
<u>PROJECT 5 - TECHNICAL EVALUATION IN SUPPORT TO THE COMMISSION</u>	13	-	0.150	(+)	-	-
<b>T O T A L</b>	116	1.145	26.620	1.290	26.505	0.250

(+) TOTALLY FUNDED BY THE GENERAL BUDGET OF THE COMMISSION

## 1. PROJECT = H.F.R. (HIGH FLUX REACTOR)

### 1.1. BACKGROUND

The continuation of HFR as a service activity within JRC is proposed for the following reasons :

- successful operation and exploitation of the reactor under the current program, documented by its annual reports and confirmed by the Statements of the competent Advisory Committee.
- a number of specific competences and techniques which could not be simply transplanted, e. g.
  - . multi-purpose reloadable capsules ("TRIO", Table E-I-10/b),
  - . special facilities for reactor safety research (BWFC, Table E-I-10/e; LOC, Table E-I-10/f together with their extensive out-of-pile equipment),
  - . large installations for solid state and nuclear physics,
  - . several facilities for large-scale production of short-lived radioisotopes,
- experience over the current four years' plan has revealed a general technological benefit from HFR, conveyed either by direct publications or ultimate availability of the acquired results.

#### Present utilization

Main users of the irradiation capacity of the HFR are the large technological research centres and the industry of the participating countries as well as the JRC Establishments of Ispra, Karlsruhe and Petten.

Secondary facilities like beam tubes, single capsule conveyers and isotope production rigs are for the most part in permanent use by universities or research organizations and industry of the Netherlands and other countries. The different groups of irradiation experiments are summarized in Table a below.

The experience gained during the current multiannual programme shows that the degree of reactor occupation, which varies between 50 and 80 %, is limited by the staff available for development, design, manufacture, and operation of irradiation devices, rather than by a shortage of irradiation projects.

TABLE E-I-10/a

HFR Petten Distribution of the Mean Annual Utilization in 1975.

Graphite	33 %
Structural materials	13 %
LWR fuel	10 %
Fast breeder reactor fuel	10 %
Horizontal beam tubes and isotopes	15 %
Miscellaneous	19 %
	100 %

#### Health of Reactor and Plant

A tight schedule of regular periodic maintenance and inspections has been followed since the HFR began to operate more than 13 years ago.

The strict observation of a regular maintenance scheme has kept failures of components and unscheduled shut-downs at a minimum. The high availability of 285 days per year gives evidence of the optimum condition of all systems.

A large number of out-pile components have been replaced by new and/or more modern ones. This holds particularly for electronic equipment and for general purpose installations for experiments.

As far as in-pile parts are concerned, major replacements planned and/or carried out cover :

- the central top cover
- core clamp-down devices ("grid bars")
- Be reflector elements

It can be seen that, apart from the reactor vessel itself, all components subject to neutron irradiation can be replaced at acceptable cost and in a short time.

Particular attention has therefore been paid to the state of the reactor vessel, which is in a perfect condition for continued operation. Regular under-water video recorder inspections have, till now, not revealed any visible cracks or other damage to the wall.

An assessment of all other systems of the HFR was made in order to determine their present state and the expectance of their future functioning. It was found that some of the potential repairs could require a maximum shut-down of 3 weeks. A repair of the vessel wall could be made in less than 2 months time.

## State of Irradiation Technology

Experimenters find extensive technical and scientific support by specialists of the Petten groups providing skill, equipment and development activities in irradiation technology.

The special fields of activity developed around HFR Petten, and to be pursued in future are :

- graphite irradiations up to 1200 °C for production parameter control,
- in-pile creep experiments on graphite, fuel, zircalloy and refractory alloys,
- transient and abnormal condition irradiations on fast breeder reactor (FBR) and light water reactor (LWR) fuel pins (experiments with power ramps, power cycling, loss-of-coolant, transient over-power),
- high temperature, high fast fluence performance testing of advanced fuel for the high temperature gas-cooled reactor (HTGR), for control of new and revised designs and production methods,
- in-pile investigations of new alloys and new designs for FBR and LWR structural materials (cladding, grids, spacers, wrapper tubes).
- technology of in-pile high temperature thermometry

Examples of proven irradiation devices are shown on the following pages, viz. :

- the multi-purpose capsule for three independent specimen carriers ("TRIO", Table E-I-10/b),
- a facility for in-pile on-line measurement of graphite creep (Table E-I-10/c),
- an arrangement for irradiation of HTGR fuel compacts or spheres ("FSC rig", Table E-I-10/d),
- the LWR Boiling Water Fuel Capsule ("BWFC", Table E-I-10/e),
- the fast breeder reactor fuel loss-of-cooling capsule ("LOC", Table E-I-10/f).

Other facilities and techniques will be developed as new tasks come up, corresponding to the evolution of nuclear technology.

- |                               |                    |
|-------------------------------|--------------------|
| 1. rig head                   | 7. thermocouples   |
| 2. support with extensions    | 8. shield plug     |
| 3. in-pile part               | 9. extensions      |
| 4. vertical displacement unit | 10. TRIO-thimble   |
| 5. seal plug                  | 11. sample carrier |
| 6. demountable joint          |                    |

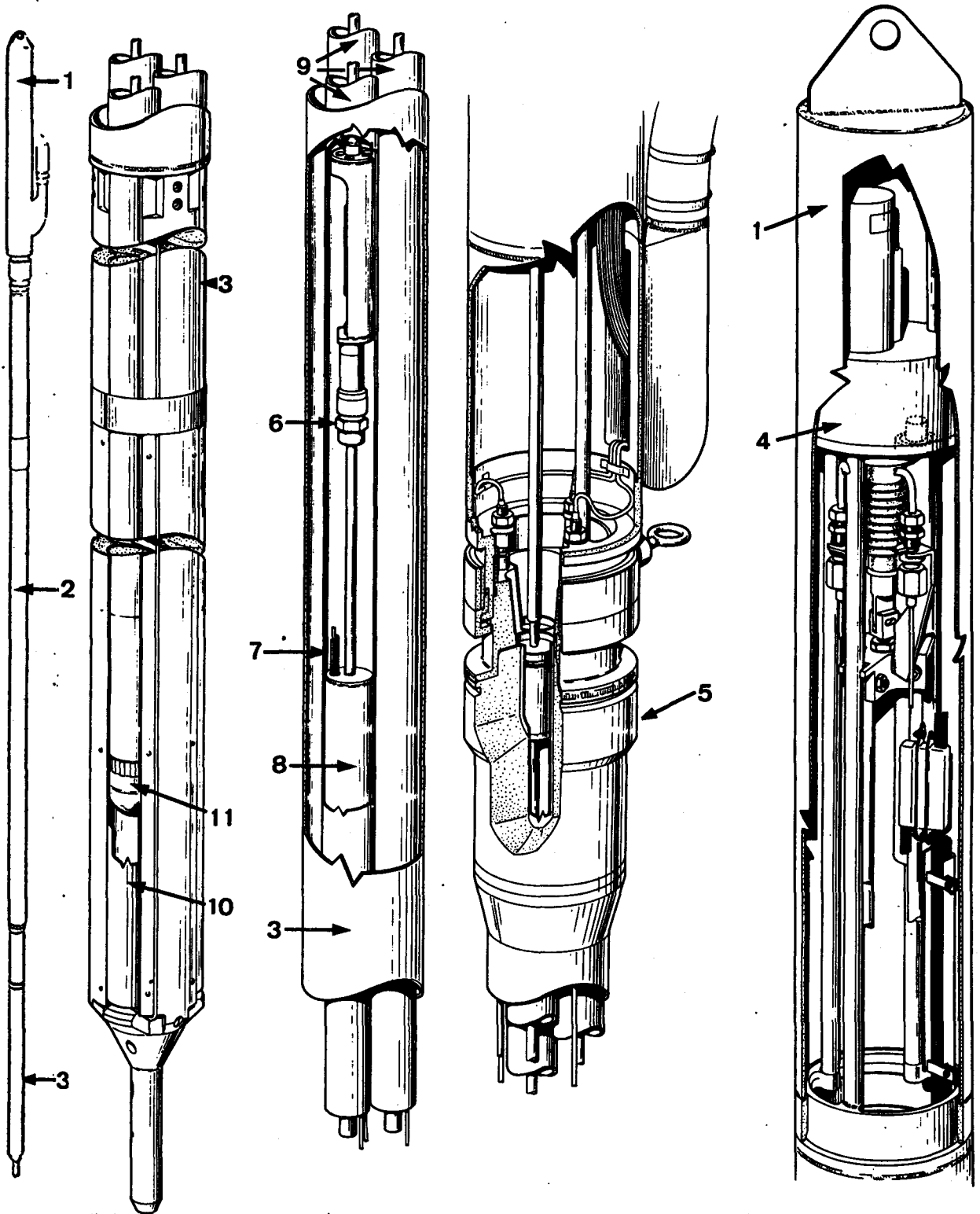

TABLE E-I-10/b

394 GENERAL ARRANGEMENT ILLUSTRATION OF THE TRIO CAPSULE



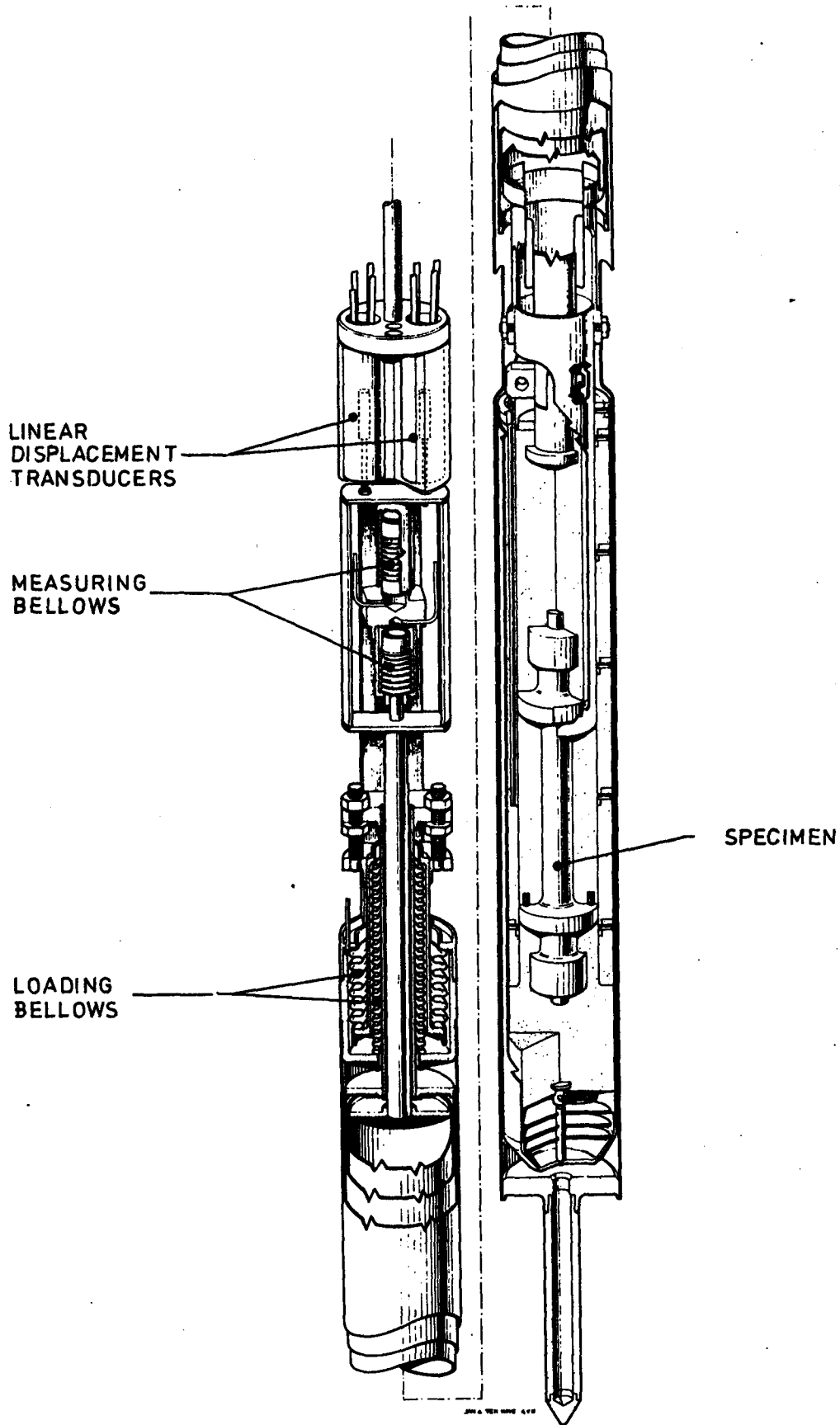

TABLE E-I-10/c

IN-PILE GRAPHITE CREEP FACILITY

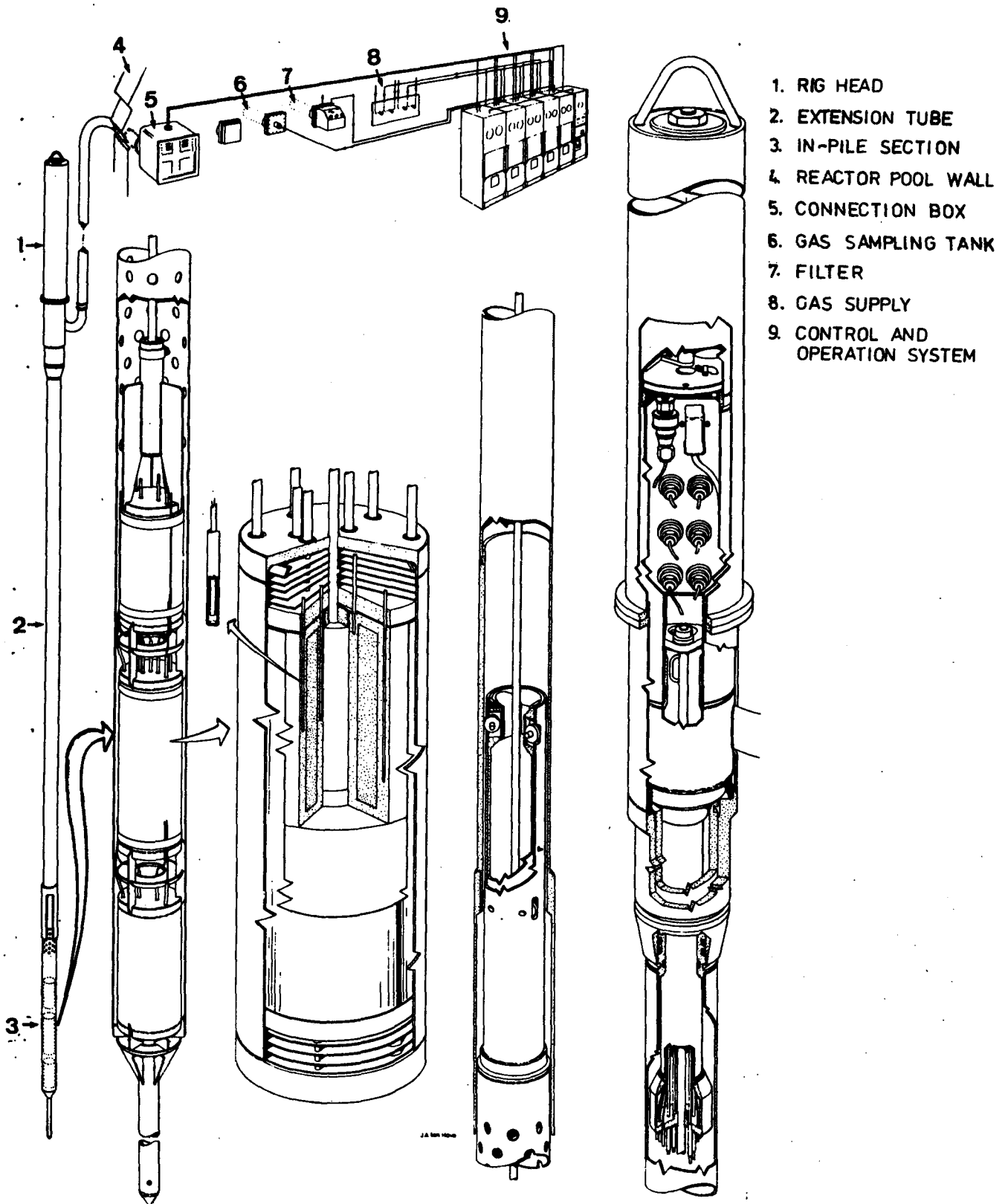

TABLE E-I-10/d

ILLUSTRATION OF A FSC TYPE RIG AND OUT-PILE INSTALLATION

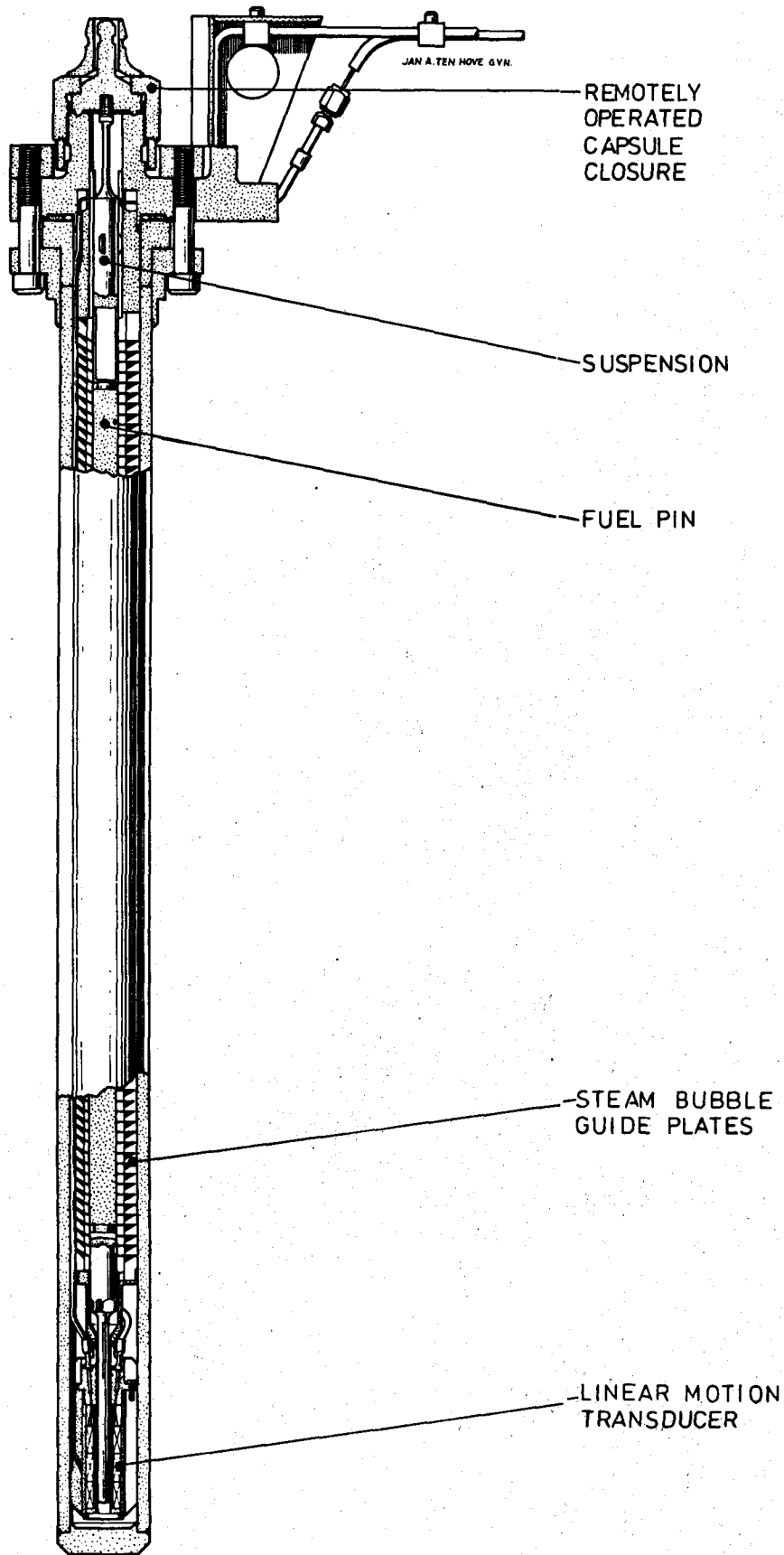
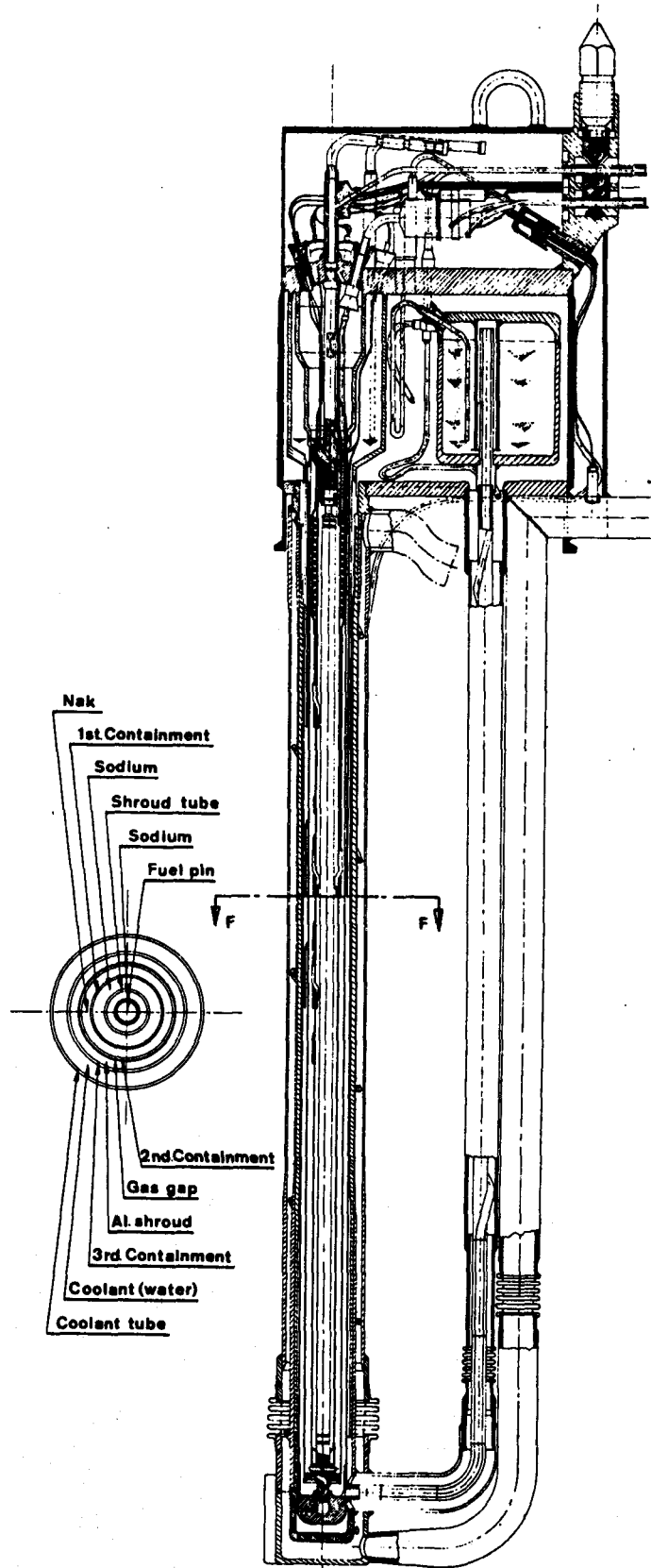

TABLE E-I-10/e  
BOILING WATER FUEL ELEMENT CAPSULE  
(BWFC) WITH ELONGATION TRANSDUCER.



Loss of Cooling Capsule

TABLE E-I-10/f

## 1.2. TECHNICAL DESCRIPTION

It is proposed to continue the operation of HFR as a direct action of the Joint Research Centre.

After 1976 the reactor will continue operation without significant changes in terms of operating parameters, organisation and finances.

This implies in particular :

- conservation of the main operating parameters,
- conservation of organisational and management schemes, as compared to the current situation
- day-to-day plant operation by the Dutch Reactor Centre RCN on contract basis on behalf of the Commission.

A new reactor central top lid, together with an improved core configuration, will already be introduced by the end of 1976. Specific expenses for the reactor, beyond the routine maintenance, should enable the following modifications to be carried out :

- new instrumentation and main control desk,
- new remote handling facilities,
- replacement of obsolete equipment for irradiation device manufacture,
- replacement of temporary sheds by an extension of the existing building.

### Reactor Utilization

Hereunder are indicated some particular trends of the development of the nuclear power reactor technology, as they are of potential relevance for the utilization of the materials testing capacity in the H.F.R.

#### Water cooled reactors

- increasing safety and reliability research such as overpower, power cycling, power ramp and loss-of-cooling investigations
- compatibility problems in advanced fuel technology (e.g. cladding/fuel interactions) influenced by fuel cycle parameters, development of new burnable poison materials and Pu recycling (mixed oxide fuels)
- fabrication problems of large steel pressure vessels leading to the study of alternative methods such as cast iron or concrete constructions and to materials and fabrication technology development (e.g. welding and forging), fracture mechanics research
- growing secondary technological research demand, e.g. from power reactor operators (reliability aspects, core succession, alternative fuel material combinations) and from organizations in developing countries interested in the introduction of nuclear technology.

## High temperature reactors

- increase of coolant temperatures to levels making process heat applications and direct cycle conversion attractive
- more severe demands to limitation of activity release in gaseous and solid form (Sr, Cs, J, Te, Ru), application of oxygen and fission product getters in fuel
- control of tritium level and mobility, mainly in process heat application with hydrogenous environment
- further development of Th/U-233 cycle technology e.g. on lifetime increase of feed particles, and on handling of active targets
- improvement of coated particle fabrication and reduction of particle rupture rates
- improvement of graphite component lifetime, e.g. non replaceable reflectors, studies on large graphite components fracture mechanics.

## Fast reactors

- cladding corrosion problems of sodium cooled reactors, investigations to increase service life of fuel elements
- change-over from oxide to carbide fuel, carbon effects on cladding at higher temperatures limiting mechanical properties (lack of long-term data)
- investigations on the use of europium-oxides and -bOrides and tantalum as alternative absorber materials to increase service life with respect to present boroncarbide absorbers
- safety and reliability research objectives very similar to the subjects mentioned under "Water cooled reactors"
- gas cooled breeder reactor : change-over from steel to ceramics as fuel particle containment to permit temperatures around 1000°C

Under consideration of the present interest in the irradiation facilities of the HFR and the evaluation of some trends in the nuclear technology as presented above the contours of the future utilization of the HFR can be identified :

TABLE E-I-10/g

Probable Future Utilization

	1977/78	1979/80
Graphite, HTGR fuel	30	25
Structural materials	10	8
LWR fuel	12	10
Fast breeder reactor fuel	15	18
Horizontal beam tubes and isotopes	17	20
Miscellaneous	16	19
	100 %	100%

### 1.3. MANPOWER AND COSTS

#### - Large Investments

Large investments beyond the routine budget are the following  
(for 4 years) : (value 01.01.77)

	(10 <sup>3</sup> UC)
- reserve for the replacement of large reactor components	70
- new reactor control desk	25
- new recording facilities	40
- electron beam welding installation	100
- extension of reactor building	300
- new hot cell equipment	80
- machine tools and measuring equipment	110
Total, 4 years	725
=====	
- Running Cost (without JRC personnel cost)	
The annual budget required ( <u>value 01.01.77</u> ) is estimated as follows :	
	(10 <sup>3</sup> UC)
Fuel cycle	1.255
Electricity, insurances, miscellaneous	400
Day-to-day operation (under contract)	3.510
General technical expenses	525
Total annual	5.690
=====	

PROGRAMME : SERVICE AND SUPPORT ACTIVITIES				
PROJECT 1 : HFR (HIGH FLUX REACTOR)				
	1977	1978	1979	1980
RESEARCH STAFF	42	42	42	42
INVESTMENTS (K.U.A.)	←----- 725 -----→			
RUNNING COSTS (K.U.A.)	5690	5690	5690	5690
CONTRACTS (K.U.A.)	-	-	-	-
RESOURCES (K.U.A.)	100	100	100	100
EXPECTED INCOME (K.U.A.)	-	-	-	-



ADVISORY COMMITTEE  
ON PROGRAMME MANAGEMENT

"HIGH FLUX REACTORS"

OPINION

by the Advisory Committee for Programme Management "High Flux Reactors"

The Advisory Committee "High Flux Reactors" is of the opinion that

1. the anticipated future requirements for materials irradiation testing, as outlined in document HFR 106/1, as well as the satisfactory operation and exploitation of HFR Petten during the current programme justify the continuation of the action, within a new multiannual JRC programme,
2. the reactor and its facilities are and will be in a position to meet requirements for advanced irradiation tests,
3. the reactor could play an important part in power reactor research and development during the coming years.

Petten, February 23, 1976

## 2. PROJECT: INFORMATICS

### 2.1. SUBPROJECT: EUROPEAN INFORMATICS NETWORK (COST 11)

#### 2.1.1. Background

The need of facilities to connect big computers built by various manufacturers to constitute a large heterogeneous network of informatics resources, was felt since the second part of the 1960'ies.

This need was based on various economic considerations:

The cost of the software development is ever increasing and the adaptation of sophisticated software to various types of computers is very expensive; it is far better to use the software on the computer for which it was first conceived.

Even if computers are described as "general purpose", some of them are best adapted for special classes of problems and it is economic to solve each problem on the best computer available.

The usefulness and rentability of large "data banks" is highly increased if they can be consulted very rapidly by numerous computers.

The cost of the data transmissions is highly reduced if these transmissions are conveyed on specialized channels at very high rate.

Aware of these problems the Department of Defense of the USA financed the studies and the creation of a broad network extending from East to West of the Continent (ARPA Project).

The networks previously built were homogeneous and of the stellar or fully connected type, working on a message basis. These solutions were unacceptable for this kind of network: either the security would have been too low, or the price too high.

The studies of ARPA have introduced two new concepts: "mesh network" and "packet switching". The problems involved in such kind of network are numerous and complex: they concern first the characteristics and the behaviour of the telecommunication sub-network and secondly the protocols between the computers and the synchronization of their respective processes, as well as the access to the data banks and the interpretation of their contents.

The usefulness of such networks for scientific and commercial purposes is unquestionable. They allow the users the access to the most adequate hardware and software for the solution of their various problems and reduce the time and cost of such access.

Within the context of the European Scientific and Technical Cooperation, the Commission decided in 1968 to study the opportunity and the feasibility of an international project for the development in Europe of such a network having properties similar to those of ARPA. Though developing national networks themselves (France: CYCLADE network; U.K.: EPSS; Germany: DATANET), some of these countries

signed in November 1971 the agreement for the COST 11 project. Taking into account the special interest of this project for the European informatics industry and bearing in mind the interest of the countries of the European Community which did not sign the agreement, the Commission has taken part in COST 11 just as the other participants and has nominated the Ispra Establishment of the JRC as its scientific and technical representative.

The agreement was originally signed by France, Italy, Norway, Portugal, Sweden, Switzerland, United Kingdom, Yugoslavia and the Commission, but the Netherlands joined the project in August 1974, and Germany in January 1976.

The coordination of COST 11 and the administration of the common funds is ensured by a Management Committee composed of representatives of each signatory. An Executive Body appointed by the Management Committee is charged with the daily work of coordination and takes technical and scientific advice from the Technical Advisory Group composed of specialists selected by the signatories.

Five countries have nominated Informatics Centres whose computers have to be connected to the first experimental network:

France	IRIA - Rocquencourt; University of Grenoble,
Italy	Politecnico di Milano,
Switzerland	E.T.H., Zürich,
United Kingdom	N.P.L., Teddington,
Commission	JRC, Ispra.

### 2.1.2. Technical Description

As explained before, the project consists in connecting physically and logically five computers of various manufacturers. The physical connection implies the construction of a telecommunication sub-network dedicated to the data transmission. The necessary studies for the specification have been carried out during the years 1972-1973, and the design is such that the European Informatics Network will be able not only to allow data transmission between computers, but also to connect national, not directly compatible networks. A European consortium (SESA LOGICA) is in charge of the realisation of the sub-network, and this will be connected during the second quarter of 1976.

The logical connection is a very complex work. It implies the definition of standards at various logical levels and the implementation of these standards on the various computers. Obviously, the definition of the standards requires a very close cooperation between the five centres.

The standards of the lowest levels are partly defined and the development of the relative software will be probably finished during 1976, allowing in this way communication between the various computers.

The more complex research work will remain to be done. It consists in the necessary studies and implementations to present to the users the various resources of the network as a unique and homogeneous, multi-processor computer. The problem is so large and complex that it is worth being treated in parallel on a worldwide basis, by numerous

teams of informaticians.

The Executive Body takes care of the relations with the other networks. The Centre Coordination Group where each participating centre has a representative is providing the necessary coordination of the study and exchange of information inside the project.

Due to the international character and the experimental aspect of COST 11, it is very difficult at this stage to provide detailed proposals for the research to be performed in Ispra during the coming years. Probably, they will have to be reviewed to take account of the collegial decisions of the various committees. In any way, an attempt should be made to study the more general problems and to implement the more practical tools in the most portable way, in such a manner as to make the results as useful as possible for all the other participants.

For the moment three topics have been selected for study :

- i) general architecture of the network operating system
- ii) virtual units of the network (definition of standards guaranteeing compatibility between various implementations)
- iii) participation to the specifications of the Network Control Language

It is not possible to treat the study in a strictly sequential way. Study ii) must be intended as a permanent one because it implicates also the taking into account of the developments and specifications from other networks to ensure the best possible compatibility between networks. Study i) regarding the general aspect, is the most urgent one, it has to be treated in 1975-1976 but the ultimate part probably will cover also the beginning of 1977. The detailed study of some parts of the architecture will probably continue and be carried out when they will be needed. Before beginning study iii) all the other studies, not depending on JRC - ISPRA must have reached a high level.

With the implementation of the software, it is considered to provide on experimental basis after agreement of the Management Committee :

- a) the possibility for remote users to access Ispra batch facilities
- b) to local users the access to remote conversational, time-sharing facilities (this depends of course on the developments made by the other participants)
- c) access for Ispra users to remote job entry in other centres, and to remote data banks
- d) experiment locally multiprocessing facilities.

At most, two problems will overlap. It will be tried to follow the order specified. Point d) is surely the last one to be treated and may not be completed during the period of the project. It depends on the studies and development done in almost all the centres. It is the most complex and ultimate goal but the first 3 still represent a good practical realisation. Points b), c) may be developed in any order depending chiefly on what is done elsewhere in the cooperating centres.

### 2.1.3. Planning

As a guideline it is expected:

- point a) will be completed in the middle of 1977
- points b), c) - will begin to be operational in the middle of 1978 and fully operational at the end of the same year,
- point d) will be approached during 1979.

### 2.1.4. Manpower and Costs.

PROGRAMME : SERVICE AND SUPPORT ACTIVITIES				
PROJECT 2 : INFORMATICS				
SUB-PROJECT 1 : EUROPEAN INFORMATICS NETWORK - COST 11				
	1977	1978	1979	1980
RESEARCH STAFF	5	5	5	5
INVESTMENTS (K.U.A.)	190	10	10	10
RUNNING COSTS (K.U.A.)	200	200	200	200
CONTRACTS (K.U.A.)	70	85	90	75
RESOURCES (K.U.A.)	-	-	-	-
EXPECTED INCOME (K.U.A.)	-	-	-	-

## 2.2. SUBPROJECT: EUROPEAN COMPUTER PROGRAM INSTITUTE (EUROCOPI)

### 2.2.1. Background

In Europe, as in the rest of the world, the use of computers has grown rapidly during the past decade. Consequently, computer applications have advanced quantitatively, many programmes being written by software companies, computer firms, universities, industries and government bodies.

Nevertheless, the development of new programmes involves increasing costs (a rate of increase of about 12% per year has been estimated for Europe), and service on the European level aimed at promoting software sharing is therefore considered necessary.

For an efficient software exchange, firstly there is need for complete and objective information on the software available on the market; secondly, suitable ways to access programmes must be available. To this purpose different attempts have been made. They may be classified into four major types:

Creation of programme libraries, usually operating on a disciplinary basis and in certain geographical areas.

Organization of programme indexes, often compiled and maintained by national institutions, professional associations, computer manufacturers or specialized publishing companies.

Establishment of centres offering programmes for use on a computer service bureau basis and based on computer network.

Creation of users groups based on machine range affiliation or substantial specialist packages.

In spite of the number and variety of the attempted solutions, the situation of software sharing in Europe is still far from being satisfactory. The principal reasons seem to be the sectorial and national character of the existing activities and the lack of sufficient coordination at a European level.

In 1971 an activity was initiated at the JRC with the long-term scope of:

- promoting cooperation on a full European basis for a complete information service on scientific/technical software;
- improving programmes exchange especially in those fields of computer applications in which European programme libraries do not exist.

The short-term objectives of this action, known as EUROCOPI, were:

- the setting-up of an experimental computerized data base on programmes information and the development of the necessary information tools;

- the organization of a programs distribution and programs information dissemination service on an experimental but operational basis.

The results obtained and the users interest have proved the feasibility and the usefulness of developing an efficient information network on computer programmes having EUROCOPI as the point in which information collected on particular subjects and/or on national basis, can be assembled and redistributed.

Potential European software users could in such a way easily get exhaustive information on the available programmes and rapidly access them.

The expected result is a considerable saving of money and a better utilization of the available human resources.

It is now recognized all over Europe and even outside, that EUROCOPI fulfils an important function in disseminating knowledge of computer programmes and applications throughout the Community. EUROCOPI even though not yet operating at full capacity is now well established and it is used by the staff of more than 500 organizations in Europe. More than 2000 copies of EUROCOPI publications and about 700 programmes are distributed per year.

TABLE 1 - INSTITUTIONS USING EUROCOPI SERVICES (1975)

Belgium	17	United Kingdom	101
Denmark	18	Ireland	14
France	49	Other European	
Germany	86	Countries	64
Italy	123	International	
The Netherlands	34	Organizations	31
		Others	39
		Institutions of the EEC	= 442
		Institutions outside EEC	= 134
		Total	= 576

Cooperation agreements have been established already between EUROCOPI and various organizations, namely SIZSOZ (Gesellschaft für Mathematik und Datenverarbeitung, Bonn), PLU (Edinburgh University, U.K.); CPC Programme Library (Queen's University, Belfast), C.S.A.T.A. (Università di Bari, Italy), SEAS (Share European Association), IUG (Ices Users Group).

Other agreements are near to be finalized.

A consortium, called ECSIR (European Consortium for Software and Information Transfer in Research and Teaching), has been formed in November 1975 among EUROCOPI, the Program Library Unit of Edinburgh, and the SIZSOZ Project of the GMD, Bonn.

The consortium is open to new members among bodies (software libraries, Information services, Distribution agencies, users groups), who are interested in library collections and services concerning software and related information on a European basis.

With the purpose of bringing together those who would like to participate in the setting up of a detailed work programme and to formulate propositions for future activities, the Consortium has started the organization of a Conference to be held at Ispra in February 1976.

These facts, together with the existence of a well trained staff and of suitable informatics tools, are good arguments for a continuation of the activity at the JRC along the lines defined in this project. In the future EUROCOPI is aimed to get on, at least partly, as a self-supporting service.

It must also be mentioned that the other proposed activities for the JRC would certainly benefit of the EUROCOPI services. There is, in fact, a general need for application software in the classical fields of research of the JRC ( Nuclear Reactor Physics and Engineering, etc.). Also the proposed actions concerning portability will be certainly useful to the JRC in view of possible radical modifications of the computing installation.

### 2.2.2. Technical Description

The proposed activity can be subdivided into the following points:

#### 2.2.2.1. Programme Information Service

- a) Promotion of the cooperation among European programme libraries/ programmes information centres/users' groups operating in the field of scientific/technical software in order to improve the exchange of information and finally the sharing of software within the European Community.

The actions to be undertaken will include:

- the organization of regular meetings in which the European Programme Libraries /Information Centres can confront their experience and define common actions;
  - the promotion of and the participation in joint working groups for the development of standards for a programme documentation system (abstracts, thesaurus, etc.).
- b) Development and maintenance of a comprehensive computerized data base on programmes information. The collection of programmes information will be mainly based on the submission, by Programme Libraries /Information Centres and by programmes authors/owners of abstracts in computer readable form and possibly according to a standard.
- c) Diffusion of information by issuing Programme Indexes and Programme surveys, by answering queries on specific subjects, and by direct interrogation through the use of terminals and network.

#### 2.2.2.2. Programme Distribution Service

- a) Promotion of actions aimed at improving application software portability.

These actions will include:

- the definition of suitable recommendations and guidelines for scientific programmes and their diffusion through courses;



- the development of tools which can help in the adaptation of existing programmes to new computers.

Part of the work will be done by the JRC in the framework of the "Software Engineering" project, but a large part has to be executed by external informatics institutes under contract.

This activity will be harmonized with the policy of DG-III.= General Directorate Industrial and Technological Affairs.

- b) EUROCOPI operates the JRC Programme Library and the European Distribution Agencies of SEAS (SHARE European Association) and I.U.G. (ICES Users' Group).

Other non-European libraries, collecting programmes in science and technology which are of interest for European users, have been contacted in order to set up and operate European Agencies. The agreements will be finalized already in 1976. The goal is to make the acquisition of programmes, developed outside Europe, easier and less expensive.

The possibility of promoting the formation of Users' Groups related to European Computer Manufacturers, will be exploited. EUROCOPI could act as distribution agency.

#### 2.2.2.3. Advertizing, Administration

As a service, EUROCOPI is expected to be at least partly self-supporting. To achieve this goal, not only the quality of the service, but also the number of customers is important.

For this reason and in order to be of the largest possible usefulness, the services provided by EUROCOPI have to be advertized by all suitable means.

An efficient monitoring of the various operations must be implemented to be able to provide a reliable service.

#### 2.2.3. Planning

	1977	1978	1979	1980
Data Base Size (NO. of program abstracts)	4500	6000	8000	10000
Program Indexes, etc (NO. of copies sold)	500	800	1000	1200
Program Distribution (NO. of programs/manuals distr.)	1500	2500	3500	4000

2.2.4. Manpower and Costs

PROGRAMME : SERVICE AND SUPPORT ACTIVITIES				
PROJECT 2 : INFORMATICS				
SUB-PROJECT 2 : EUROPEAN COMPUTER PROGRAM INSTITUTE (EUROCOPI)				
	1977	1978	1979	1980
RESEARCH STAFF	12	12	12	12
INVESTMENTS (K.U.A.)	-	-	-	-
RUNNING COSTS (K.U.A.)	100	120	140	160
CONTRACTS (K.U.A.)	85	85	85	85
RESOURCES (K.U.A.)	20	35	55	80
EXPECTED INCOME (K.U.A.)	20	35	55	80

2.2.5. Associations with External Organizations

As already mentioned, this project has been envisaged as a collaborative effort between EUROCOPI and the largest possible number of European Programme Libraries /Information Centres/Users' Groups operating in the field of scientific/technical software.

Agreements for collaboration have been finalized already with:

- CPC (Computer Physics Communications) Programme Library, Queen's University, Belfast, U.K.,
- PLU (Programme Library Unit), University of Edinburgh, U.K.,
- SIZSOZ (GMD, Bonn, W.-Germany),
- SEAS (Share European Association)
- ICES User's Group
- C.S.A.T.A. (Centro Studi Applicazioni Tecnologie Avanzate), Università di Bari, Italy.

Other agreements are in development (e.g. NEA-CPL;QCPF)

## 2.3. SUBPROJECT: EUROPEAN SHIELDING INFORMATION SERVICE (ESIS)

### 2.3.1. Background

Since more than 14 years, a shielding group exists at the JRC, composed of approximately 10 physicists, engineers and experimentalists. This team has developed its activities in the theoretical and experimental fields.

The competence built up in the course of the years favoured the collaboration possibilities with the different nuclear industries and the National Research Centres in the area of the Community, such that this shielding group cooperated in many of the Continental prototype projects.

As a large part of the JRC shielding activity consisted in technical support, it was thought to rationalize and formalize this activity by instituting a Shielding Information Service offering its support to those engaged in shielding work; thus ESIS (European Shielding Information Service) has been officially constituted at the beginning of 1972.

Recently, a close cooperation has been established between ESIS and the INDAC group (INDAC - Integral Nuclear Data Centre). This last group was created with the initial scope of performing and analyzing integral core experiments. In the course of the years the theoretical part of this activity shifted (on the request of the ACPM for Information Analysis Services) towards the evaluation, retrieval and processing of nuclear data, mainly for shielding applications.

Following a recommendation of the same ACPM, the activities of ESIS and INDAC should be merged, in a future pluriannual programme, with a reinforced ESIS activity.

ESIS is a service in the field of radiation shielding, intended for engineers engaged in design problems or research; it collects, analyzes, evaluates and circulates shielding information concerning nuclear reactors (fission, fusion) and accelerators. Beyond the scope of mere information and purely technical activities, ESIS tries also to promote contacts and to contribute to a close cooperation by acting as a central clearing house between the various European Shielding Groups.

The European reactor shielding scene is rapidly changing. Up to some years ago, shield design methods and data needs still were strongly project-oriented and partially represented empirical approach. With the advent of the new computer generation (high speed, large memories), more sophisticated techniques are used leading to the establishment and common use of one-dimensional and two-dimensional numerical transport programmes.

In principle, these codes allow the exact solution of the one, two or three dimensional Boltzmann transport equation, such that besides the numerical approximation the only major errors involved are those originating from the cross section input. As a consequence, nuclear data requirements, both in quality and quantity, are of increasing importance. They may be met either by differential measurements or by clean integral shielding benchmark experiments.

On the other hand, the request list for new data may be established on a scientific basis by performing sensitivity calculations, the methods of which are under development.

The range of open shielding problems is increasing; in addition to radiation penetration problems in thick shields, heat deposition calculations, radiation streaming and health physics aspects, new topics such as radiation damage (fission and fusion reactors), impact of reactors on environment and neutron shielding of fuel with high burn-up (transport flasks, reprocessing plants, hot cells) are enlarging the shielder's activities. These problems may be tackled by the above mentioned design tools. Benchmark experiments with a clearcut perspective of separation between methods and data, may give a useful information, either on basic data and methods.

Problems concerning radiation protection from nuclear reactors have recently gained considerable attention for two reasons: one is the general safety aspect and the other the demand of better plant availability.

Different national regulating guides spelled out the necessity of new efforts and the increased responsibility for radiation shielding, especially in the light of high costs of "man-rem" which led to the requirement of exposing operational personnel to radiation doses, as low as practicable.

The recent revision of the general shielding philosophy, the new trends in design tool developments, the data requirements and their scientifically justified identification, the numerous open problems arising for all types of reactors justifies more than ever the continuation and intensification of the ESIS activities as an enterprise performed on the level of the European Community. The competence for doing so certainly exists at the JRC. The way in which services are offered is based on the consideration that today's information explosion makes it imperative to increase the efficiency of the information transmission process. One will cope with this information explosion only if some scientists are prepared to commit themselves thoroughly to the job of reviewing, analyzing, evaluating, and synthesizing information, i.e. to handle information with sophistication and competence.

Also in the US and the USSR these activities are concentrated at information analysis centres. Shielding information is collected and disseminated through the "Radiation Shielding Information Centre (RSIC)" at Oak Ridge National Laboratory; shielding data are evaluated and distributed at the National Cross Section Centres at Brookhaven National Laboratory and the "Centre of Nuclear Data" at Obninsk.

### 2.3.2. Technical Description

The ESIS working programme is articulated in the following main lines (see also scheme):

- Nuclear Data for Shielding
- Assessment of Shielding Programs
- Shielding Experiments
- Technical Support,
- Shielding Data Bank,
- Information Dissemination.

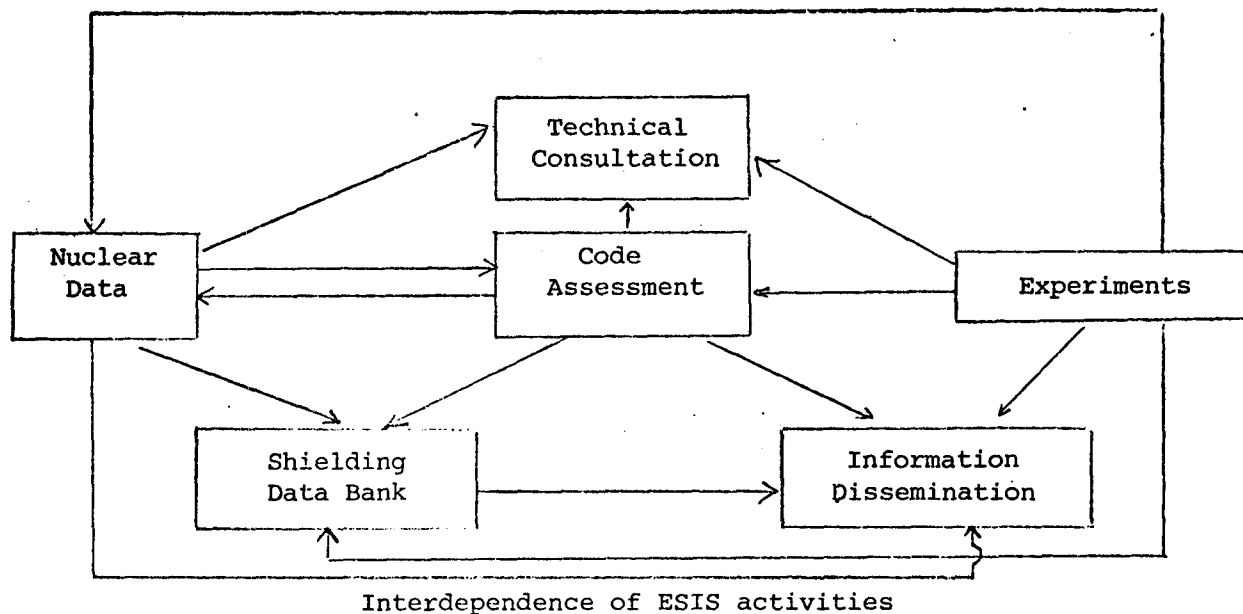

### 2.3.2.1. Nuclear Data for Shielding

This action covers three items:

- a. nuclear data evaluation
- b. nuclear data retrieval and processing
- c. sensitivity studies.

#### a) Nuclear Data Evaluation

The cross section evaluation serves for applications in shielding design, radiation damage, fusion technology and waste. Several computer programs for the calculation of cross sections have been developed in collaboration with IRK-Vienna (Institut für Radiumforschung und Kernenergetik) and will further be extended and improved.

The experience gained so far for the evaluation of activation cross sections for Mn-55, Ba-138 and Nb-93 looks very promising for the future application of these models to other isotopes which will be chosen mainly from the EEC priority requests contained in the WRENDA lists.

The evaluated data will be made available in a standard format (e.g. ENDF/B and in the form of multigroup libraries).

#### b) Nuclear Data retrieval and processing

The work on the retrieval and processing programmes for cross sections will be limited to the maintenance of the existing program systems like POPOP, AMPXI and the implementation of MINX.

The main effort will go into the display, the intercomparison and the generation of new data files, as well as the generation of standard group cross sections for shielding calculations.

According to the recommendation of the ACPM for Information Analyses Services, the ESIS group should also study the question

of error correlations in the nuclear data files by acquiring the necessary capabilities (PUFF module) and know-how and make an assessment on behalf of the European Shielding Community.

### c) Sensitivity Studies

This activity serves to direct nuclear cross section evaluations and priority requests in those areas which are most important in reactor shielding analysis (for instance gamma heating, radiation damage, total dose rate). In particular special attention is paid to the development and implementation of a 3 D sensitivity Monte Carlo code based on TIMOC. This work based on correlated tracking is regarded as being unique in its ability to handle complicated three-dimensional geometries. According to the ACPM recommendations, Ispra should compare this technique with the simpler one-dimensional approach; ESIS should also try to get from Oak-Ridge the two-dimensional equivalent of ANISN-SWAN-LAKE (DOT-VIP) and compare it with the Monte Carlo calculations.

### 2.3.2.2. Assessment of Shielding Programmes

Rather than develop new and original shielding calculation tools, ESIS studies, and if possible, improves and extends the existing available ones. The code assessment implies the following steps:

- How to use the code in an efficient way,
  - To test the code with the aim of determining the limits of applicability and the accuracy of predictions.
- a) The efficient use of a programme implies two things: namely to obtain the required results with the best possible accuracy, and to minimize the calculation time and input effort. This requires a rather detailed study of the code itself leading in practice to the right choice of the typical parameters. For instance, the user of a  $S_n$  code should know some criteria for the choice of the space and angular mesh-points; in a Monte Carlo program the question often arises how to apply correctly various variance reduction techniques to a given problem. Some of this kind of information is obtained through the practical use of the code; other information requires a more general study.
  - b) The test of a code may be realized by studying some standard problems with well known solutions (for instance analytical solutions) or by comparing its results with measurements. The comparison among different programmes applied to realistic design problems and not to academic cases, leads to a better knowledge of the advantages or drawbacks of each one.

Evidently, it is not possible to develop an activity in a systematic way for all the shielding programs, which is beyond the available means. In practice, one should try to do the jobs that will be more requested using, if possible, the know-how developed by the users or by the authors.

### 2.3.2.3. Shielding Experiments

According to the discussions within the ACPM, one of the keys for shielding activities at Ispra stems from the experimental work that is being transferred from Ispra to Pavia. Considerable importance is attached to the contribution that can be made by the EURACOS II facility (disk neutron source), especially in the iron benchmark experiments.

The work on EURACOS II will be extended to bring spectroscopy into the Common Benchmark Shielding Programme (involving Cadarache, Winfrith, Karlsruhe, Casaccia, Ispra, Universities of Stuttgart and Tokyo).

Due to its unique features (high source intensity, well defined neutron spectrum, clean source geometry) EURACOS could also be used in conjunction with water filters for hardening the neutron spectrum. Always according to the ACPM, some studies should be attempted for measuring the secondary gamma spectra in materials such as iron blocks; here again gamma spectrometry would be required.

In the immediate future programme the shielding work at Ispra will concentrate on single and multislabs benchmark experiments; the latter could prove very important in complementing the project work on practical shield design. Shielding benchmarks on neutron streaming are also foreseen.

### 2.3.2.4. Technical Support

The competence built up in the past and the experience gained in the specific field were directly fed into shield design problems. Thus, the shielding group activity contributed to the following projects: SNR (Interatom), CIRENE (CISE), PEC (CNEN-NIRA), Otto Hahn (Geestnacht), Enrico Fermi (FIAT), THTR (BBK), DICRIT (EIR); the group also collaborated with GAAA, SIEMENS, AEG, ENEL, SAIGE, AGIP Nucleare, IKE (Institut für Kernenergetik - University of Stuttgart), University of Hannover and others on shielding questions of general interest. The interventions have been done on the basis of service - or collaboration contracts or agreements. Technical advice through letters, telephone calls and visits have become a common practice. Though it is felt that an Information Service should not be heavily engaged in specific projects work, contact with the reality of projects must be maintained, otherwise the competence will be lost. Moreover, many results of the project-oriented calculations or experiments are often directly usable for the code assessment studies; in other words they are of a general interest. As a consequence, in the future the group will try to be engaged at least in one reactor project, through service contracts.

### 2.3.2.5. Shielding Data Bank (SDB)

Through the establishment of the shielding data bank (SDB) it is intended to speed up access to and retrieval of shielding information. The bank is subdivided into various classes, such as e.g. bibliography, experiments, cross sections etc. In a first phase, the data bank handles only bibliographic items delivered by the weekly scanning of periodicals, reports and books. The yearly

growth is estimated to lie between 450-500 new titles. The class "bibliography" has now been implemented definitively and will be fed with new items during the next years. Also in the next years the retrieval system will be extended to the other classes, such as experiments, cross sections, shielding materials etc. Once filled with sufficient information, the SDB will be made available to the European shielding community.

#### 2.3.2.6. Information Dissemination

The ESIS staff will analyze the information interesting to shielding in general and nuclear data in particular, as soon as it is published. Some thirty periodicals and the reports arriving at the main library are examined regularly. For each document considered pertinent, information is published in the quarterly Newsletter and stored in the SDB.

In this activity the staff has the cooperation of the Information Management services of Luxemburg and ZAED-Karlsruhe. The main channel through which the information is delivered is the quarterly Newsletter. It provides a panorama of the events and progress interesting the shielding Community with particular attention to the European situation. About 40 % of the contents are contributed by the shielding specialists of the various organizations and nuclear firms.

As in the past, the publication of 4 Newsletters per year is foreseen plus two special issues concerning benchmark experiments, reports on meetings or state-of-the-art reports. ESIS also has the intention to organize workshops on shielding programmes (once a year) which have been assessed at Ispra.

#### 2.3.3. Planning

See Table E-I-10/h

#### 2.3.4. Manpower and costs

PROGRAMME : SERVICE AND SUPPORT ACTIVITIES				
PROJECT 2 : INFORMATICS				
SUB-PROJECT 3 : EUROPEAN SHIELDING INFORMATION SERVICE (ESIS)				
	1977	1978	1979	1980
RESEARCH STAFF	13	13	13	13
INVESTMENTS (K.U.A.)	←----- 200 ----->			
RUNNING COSTS (K.U.A.)	60	60	70	70
CONTRACTS (K.U.A.)	40	40	40	40
RESOURCES (K.U.A.)	-	-	-	-
EXPECTED INCOME (K.U.A.)	-	-	-	-



Planning

Activity		Year	1976	1977	1978	1979	1980
1) Nuclear data for shielding	Evaluation of cross sections		Evaluation of Ba, S, P for shielding applications	Evaluation of some cross sections of priority 1 list of WRENDAs, pertinent to shielding			
	Retrieval and processing codes		Implementation of the AMPX1L system	Implementation of MINX, LINX, SPHINX	Establishment of a modular data processing system		
	Sensitivity studies		Production of new standard library EURLIB based on ENDF/B4, for common benchmark experiment	Production of coupled neutron-photon multigroup libraries on request			
2) Code assessment			Development and application of 3D sensitivity Monte-Carlo code	Sensitivity studies for fusion, waste, shielding applications, in simple and complex geometries			
			Participation in the common sensitivity benchmark programme, by means of ANISN-SWANLAKE	Sensitivity studies for the gamma production cross sections for the 37 nuclides in ENDF/B4			
3) Shielding experiments			Implementation of the 3D Monte-Carlo code TRIPOLI	Extension of TRIPOLI to photon transport; implementation of new library			
			Construction of EURACOS II	Extension of MORSE to fusion problems: implementation of toroidal geometry			
4) Technical Support	External		PEC project contract	PEC Safety report			
	Internal		Support in shielding problems and data for fusion, waste, reprocessing, safety, ESSOR, etc.				
5) Shielding Data Bank (SDB)			Implementation of different classes: visualization on video	Bibliography: Cross sections, experimental results, shielding materials			
			Filling up of SDB with data: query service				
6) Information dissemination			4 Newsletters per year; 2 special issues per year with experimental results of the common benchmark programme, state of the art reports, etc.				
			Workshop on TRIPOLI in October	Other workshops: error correlations, 3D sensitivity code, VIP, etc.			
			Shielding course in November	One shielding course per year			

419

TABLE E-I-10/h

### 2.3.5. Connections with "Indirect Actions"

The already established contacts with the information dissemination activities of the Commission Services will be pursued and increased when appropriated.

### 2.3.6. Associations with external Organizations

- ESIS participates in the German "Fachausschuss für Strahlenschutz", located at the University of Hannover.
- In the framework of the Common Benchmark Programme, ESIS cooperates with the National Centres of Saclay, Cadarache, Winfrith, Karlsruhe, Casaccia, Wurenlingen, as well as with the Centres of JAERI, the University of Stuttgart and Tokyo.

In the US, close and regular contacts with free exchange of information and materials exist with the Radiation Shielding Information Centre at ORNL, with the National Neutron Cross Section Centre at BNL and with the Nuclear Data Evaluation Group at LASL and the Nuclear Data Section of the IAEA at Vienna.

As regards nuclear industry, ESIS has close contacts with Fiat Nucleare, AGIP Nucleare, ENEL, NIRA, SAIGE, KWU, BBK, INTERATOM, GAAA and others.

## 2.4. SUBPROJECT : METHODOLOGICAL STUDIES (Software Engineering, Automatic Documentation)

### 2.4.1. Background

As mentioned above this subproject assembles the two following actions : Software Engineering and Automatic Documentation.

#### Software Engineering.

- in the computer world there is a growing concern over the deficiencies in software development on a large scale
- the concern is so serious because there is strong awareness of the rapidly increasing importance of computer software in many activities of society. The economical consequences of a deficient software production is an argument for trying to arrive at cures by new lines of research, adequate teaching, and a completely changed outlook on the entire field of software development.
- the above consideration show that rigorous "Software engineering" standards should be worked out and put into practice in order that the available resources may be used as efficiently as possible. The important problems are the transfer of software to each new generation of computer or to computers produced by different manufactures, and the control of the converted software in fulfilling its tasks.
- the enormous political and economical importance of software products and the high impact on future developments of the European Informatics Industry has lead to the proposals of actions of the Commission (x). In addition research in software engineering is in progress in many informatics research groups in Europe.
- a competence in some topics of software engineering has been already acquired in the JRC by running the programme library and carrying on research in computer system performance evaluation. A JRC activity in this field may be considered as a contribution to the Community Policy in Informatics.

#### Automatic Documentation - connection with Euronet

The Committee for Information and Documentation in Science and Technology (CIDST), in the context of CREST, was charged recently by the Council to take all measure appropriate to set up an European Network for Scientific and Technical Information and Documentation (EURONET)

The execution of the action plan is assured by GD XIII, with whom the JRC has a long tradition of co-operation. Indeed, GD XIII participates actively in the current automatic indexing project of the JRC and JRC is represented through experts in CIDST and its Technical Aspects Group.

---

(x) Ref. : Community Policy for data-processing - COM(75) 467 final.

The interest of EURONET for the JRC is two-fold :

On one hand, as a large research centre, it is a major potential user of the services offered by the system. This demands the connection of the Ispra Centre to EURONET to permit remote terminal access to data bases. Given the multiple expertise and the geographical position, Ispra could also play the role of a regional referral centre for EURONET.

On other hand, Ispra is becoming more and more involved in the development of sectorial data bases like ECDIN, EUROCOPI, ESIS, BCR, Reliability, etc., principally oriented towards an external user community. This circumstance requires the connection of such data bases (i.e. of the Ispra computer as a host computer) to EURONET.

The Ispra establishment of JRC has a long experience and recognized competence in the field of automatic documentation and in particular of automatic indexing. The software developed at JRC (SLC-II) is at present being applied in a first full-scale pilot experiment of automatic indexing. This experiment is being conducted in co-operation with GD XIII and the INIS Secretariat (IAEA - Vienna).

While this experiment regards the automatic indexing of abstracts with an intellectually compiled thesaurus, the full scope of SLC-II includes also methods of automatic thesaurus construction, automatic query processing and advanced retrieval techniques. Such automatic techniques are of a prominent importance in view of EURONET. Namely, the majority of data bases which are eventually to be linked to EURONET are descriptor-based with intellectual indexing, frequently on a co-operative basis, which creates considerable problems in regard to economy, time losses and consistency which can be optimally resolved through automation.

## 2.4.2. Technical description

### 2.4.2.1. Software Engineering

Software Engineering concerns the following topics :

- a) Programming Methodology : techniques and principles for the specification, design, analysis and implementation of software systems, including both the programming and language aspects.
- b) Software Reliability : testing diagnostic procedures, software redundancy and design for error control, validation and verification methods.
- c) Performance and Design Evaluation : considerations for economic and performance tradeoffs in design choices through modelling, analytical or empirical techniques which guide a practical realization of design objectives. It includes data collection tools such as hardware and software monitoring and measurement standards, as well as guidelines for hardware-software tradeoffs.
- d) Software Project Management : productivity factors, programming skills, training, operational and organizational features which are essential to overall cost effective, on-schedule completion of computer programs and their subsequent maintenance.
- e) Programming Development Tools and Standards : analysis and use of automatic programming tools for reducing programming costs, documentation and testing aids, and the development of standards.

It is proposed to concentrate the efforts on Performance Evaluation and Software Reliability.

However, depending on cooperation set up with national organizations and on requested support to Commission Services, the spread of effort among the above described lines may be changed.

#### Performance Evaluation

Assessing the performance of a complex computer system is both a practical necessity and a formidable technical challenge. Performance is characterized by a set of precisely defined descriptors of efficiency that help to determine how closely a system comes to meeting stated objectives. Because these may differ from system to system, and even conflict within the same system, it is important to understand not only the descriptors, but also the relationships between them and how they are influenced by choices that must be made in system architecture, design, and operations. The study of performance involves not only mastery of certain special definition and techniques, like measurement and simulation, but also a deep understanding of many themes that thread the entire fabric of computer science and technology.

This action was started in early 1975 and aimed at tuning the OS/MFT (multiprogramming with fixed number of tasks) system. Until the end of the actual programme some tools for workload analysis and tuning of OS/MFT system will be available.

The actual MFT-system will be changed for the OS/MVT (multi-programming with variable number of tasks) system. Thus, tuning of this system will be required. To become operational at an early stage it is intended to apply simulators commercially available such as CASE.

During the period of the new pluriannual programme the JRC computing installation will become more terminal oriented and hence will require other evaluation techniques.

This action will analyse the future computing needs, prepare and perform bench-mark tests on different installations. A part of it will be devoted to analysis and comparison of different operating systems.

This action is chiefly incorporated in the JRC computing centre and is therefore not reflected in the table concerning manpower and costs.

#### Software Reliability

More and more functions are entrusted to computers and the software which drives them; thus the question of its reliable functioning is highly relevant.

The proposed action aims at developing tools to assess computer application program reliability. Actually three different techniques are under development, namely :

- formal
- non-formal and
- statistical.

Formal methods are applied to prove programme properties, such as correctness determination, etc.; non-formal methods are those which apply specific programming techniques such as structured programming. Statistical methods are used to quantify the reliability of programmes using well defined test strategies : emphasis will be given to the latter techniques to allow quantification of programme reliability. Studies of already existent program testing techniques will be intensive in the beginning of the activity and reduced in favour to formal methods in the second half. The studies comprise comparison of programme languages and their use on different computers.

#### 2.4.2.2. Automatic Documentation (Connection with EURONET)

The connection of the Ispra data bases to EURONET implies a great effort from the part of the JRC as to the standardization of software, data structures, query language, etc., user education and promotion of the services offered.

While the development of data-bases is part of other JRC objectives, the responsibility for the software, the documentary and data base management methodology and the maintenance of the above mentioned data bases and banks is centralized and is part of the proposed work.

The activity concerning automatic documentation, logically, is the continuation of the work performed in the current programme period, but increasingly centred around pilot applications rather than software development.

At the end of 1976 the first phase of the pilot experiment of automatic indexing of INIS abstracts with the INIS thesaurus will be concluded and evaluated. However, the GD XIII is prepared to perform studies on the effect of the thesaurus enrichment to the indexing quality and has reserved funds for it under the condition that the present activity is continued.

As for the part of the system concerning automatic thesaurus construction, this is now ready for a full-scale pilot experiment. It is intended to choose as test-ground possibly a Community data base (or one prevalently funded by the Community), in full agreement with GD XIII and CIDST. Moreover the activity will be conducted in proper liaison with these bodies.

#### 2.4.3. Manpower and costs

PROGRAMME : SERVICE AND SUPPORT ACTIVITIES				
PROJECT 2 - INFORMATICS				
SUB-PROJECT 4 : METHODOLOGICAL STUDIES (SOFTWARE ENGINEERING, AUTOMATIC DOCUMENTATION)				
	1977	1978	1979	1980
Research staff	7	7	7	7
Investments (K.U.A.)	-	-	-	-
Running costs (K.U.A.)	35	35	50	50
Contracts (K.U.A.)	70	70	80	80
Resources (K.U.A.)	-	-	-	-
Expected income (K.U.A.)	-	-	-	-

2.4.4. Contacts with External Organizations

Deutsche Gesellschaft für Mathematik und Datenverarbeitung (GMD),  
Bonn;

Institut de Recherche en Informatique et Automatique (IRIA), Paris;

Imperial College of Science and Technology: Department of Computing  
and Control, London;

Istituto di Scienze dell'Informazione, Università di Pisa, Pisa.

Other contacts will be established in future.

-----  
IAEA (Vienna)



ADVISORY COMMITTEE  
ON PROGRAMME MANAGEMENT

-----  
"APPLIED INFORMATICS"

"OPINION"

Introduction

This document represents the collective view of the members of the "Advisory Committee on Programme Management" (ACPM) for the objective "Applied Informatics".

It was discussed at an extraordinary meeting held at Ispra on the 20-21 January 1976, specially devoted to the examination of the JRC future pluriannual programme.

Discussion

The following activity proposals were presented by the JRC staff:

- (i) European Computer Programme Information Centre (EUROCOPI)
- (ii) European Informatics Network (COST 11)
- (iii) Software Engineering
- (iv) Automatic Documentation and Data Banks
- (v) Support to Computing
- (vi) Computer Graphics Laboratory and Support to C.A.D.  
(Computer Aided Design)

In addition there were oral presentations of the status of the computing centre and on developments envisaged in teleprocessing.

The ACPM recognized the importance of providing relevant support activities to the JRC computing service and also the need to provide special service activities in informatics and allocated the activities to these two main actions as appropriate.

Recommendations

The ACPM recommended that:

1. The JRC provides a computer service complete with necessary support activities in accordance with the details presented in Annex I.

2. Within the frame of the future JRC pluriannual programme, a programme abjective "Service Activities in Informatics" be provided in accordance with the details presented in Annex II.
3. A single ACPM supervises in the future all the activities covered in Annexes I and II.
4. This ACPM be informed on the activities of the JRC Computing Installation at the Ispra Establishment, and upon request provides advice on its plans for development.

Staff

The staff implications of these recommendations are summarized in the table below. Inevitably, the numbers of staff suggested are subject to some uncertainty and in reaching its conclusion, the ACPM had in mind that other institutions within the Community might be making contributions.

---

	man years/year
<b>A. <u>Support to Computer Service*)</u></b>	
1. Programming support	6 s/t **)
2. Performance evaluation	2 "
3. Teleprocessing	4 "
4. Computer graphics and C.A.D.	2 "
5. Data bases	4 "
Total	18 s/t

---

<b>B. <u>Service Activities in Informatics</u></b>	
1. EUROCOPI	9 s/t
2. COST 11	5 "
3. Software Engineering	4 "
4. Automatic Documentation,	up to 5 "
	up to 23 s/t

---

\*) In addition to this support staff it is noted that there are at present 23 staff and 10 local employees directly involved with operating the computer. Included within this total are 4 s/t man years/year concerned with the maintenance of basic software. Approximately this number of staff will be required for the future.

\*\*) s/t = scientific/technical personnel

The ACPM is aware that other budgetary considerations are involved but at present time the members are unable to comment on them.

Annex IA. Support to the Computer Service1. Programming Support

- maintenance of application programme library
- advice and information to programmers
- maintenance of library of mathematical algorithms.

2. Performance Evaluation

For improving the efficiency of the JRC computing service

3. Teleprocessing

Development and maintenance of facilities for data acquisition, file updating, job submission and interactive execution with particular reference to work in progress in other installations and to commercially available software systems.

4. Computer Graphics and Support to C.A.D.

- to encourage and support the use of computer graphics and C.A.D. within the JRC
- to provide basic hardware and software for the use of projects within the JRC.

The work specific to particular projects should be the responsibility of the project concerned.

The first activity by this action should be a study to decide what is sensible and feasible for the computing centre to undertake. The possibility is foreseen adding a third man year/year to the activity.

5. Data Bases

To support and encourage the use of data bases within the JRC, using standard, commercially available software systems.

Annex IIB. Programme Objective "Service Activities in Informatics"1. EUROCOPI

EUROCOPI is recognized now all over Europe and even outside as a well-established and popular service. It fulfills an important function in disseminating knowledge of computer programmes and applications throughout the Community. The ACPM acknowledges as a realistic objective the recovery of about 25% of the costs as revenues from the users by 1980.

The main lines of this activity should be:

(i) Programme Information Service

- the development and maintenance of a comprehensive computerized data base on programme information;
- the promotion of cooperation among European computer programme libraries and information centres in order to improve the sharing of software within the European Community;
- the diffusion of information, mainly by issuing programme indexes and programme surveys.

(ii) Programme Distribution Service

- acting as a programme distribution agency for a specific class of scientific/technical programmes within the Community and for non-European libraries.

The promotion of these actions is aimed to improve the portability of application software.

2. European Informatics Network (COST 11)

The ACPM acknowledges the continuation of the JRC obligation to the European Informatics Network Project. It recommends to include this action, already started in 1973 as an European common project with participation of CETIS, (as representative of the Commission) into the future JRC objective "Service Activities in Informatics".

### 3. Software Engineering

This activity should concentrate mainly on the study of application programme reliability. The ACPM recommends that this activity should be executed in a close collaboration with appropriate national efforts. It considers this activity as complementary to the Community policy in informatics, and the Commission's specific proposals for action plans (DG III).

### 4. Automatic Documentation Systems

The ACPM considers this as an important and up-to-date research activity, which could play also in the future an important role on the Community level.

However, the ACPM recommends that this activity should continue only if related to the Community actional plan for Scientific and Technical Information and Documentation (DG XIII). The recommendation of 5 man years/year is dependent on confirmation by DG XIII of their interest.

---

On this statement have agreed the representatives of Belgium, Denmark, France, Ireland, Italy, the Netherlands and the United Kingdom.

The representatives of the F.R. of Germany wish to have included the following comments:

- To the opinion of the German member of the Advisory Committee the activities of the JRC in the field of data processing should be limited to pure service activities. The actions B.1 (EUROCOPI) and B.2 (COST 11) have a higher priority than B.3 (Software Engineering) and B.4 (Automatic Documentation Systems).
- To Annex I, A.3 (Teleprocessing) should be added: this activity should be based on a precise definition of the requirements for teleprocessing facilities within the JRC.
- To Annex I, A.4 (Computer Graphics and Support to C.A.D) should be added: or to stop the activity if considerable improvement against decentralized support cannot be proved.

ADVISORY COMMITTEE  
ON PROGRAMME MANAGEMENT

-----  
"INFORMATION ANALYSIS SERVICES"

" The Committee's OPINION on the Present Programme"

- 1.1 The Committee is pleased to note that the activities carried out by ESIS continue to adhere to the guidelines defined by the decision of the Council of Ministers of February 5th, 1973 and represent an important support to the European Shielding Community.
- 1.2 The Committee views with some concern the delay in the experiments with EURACOS II due to the late approval of the programme revision for 1975 and it stresses the importance of the benchmark experiments to be carried out there in the frame of the coordinated European activity in this field.
- 1.3 The Committee approves the shift of objectives in the theoretical activities of INDAC towards sensitivity studies, cross section evaluation and processing for shielding applications and the closer connections between these activities and those of ESIS.
- 1.4 Concerning the experimental activities of INDAC on the measurements of capture cross sections of structural materials (in cooperation with CNEN and AGIP) the Committee notes that the first series of measurements has been concluded successfully. The results of these experiments, together with those of other laboratories, provide worthwhile information for the reevaluation of the iron cross sections. However, it expresses the opinion that this experimental activity of INDAC should not be carried further.

The Committee's VIEWS on the Next Pluriannual Programme

- 2.1 The Committee considers that the activities carried out by ESIS and the related ones by INDAC play an important role in the Community and represent a focal point for the European radiation shielding activities and should be continued in the future.
- 2.2 One of the objectives of these activities should be that of maintaining an up-to date, high level competence in this field, so as to be able to provide advice and service on shielding problems to the various design groups and enterprises in the Community.
- 2.3 Another very important objective is to provide, in conjunction with member countries laboratories, clear guidance on the accuracy of nuclear data required for shielding purposes, and to make the greatest use of both integral and differential data in meeting these requirements.
- 2.4 The Committee therefore recommends that a programme point on a Service for Shielding be explicitly included in the next pluriannual programme, which should clearly reflect the above mentioned objectives.
- 2.5 In particular, with reference to point 2.2, the activities should continue to deal with shielding code assessment and with shielding information collection and dissemination.
- 2.6 As concerns the objectives of point 2.3, the Committee recommends to emphasize work on sensitivity studies, benchmark experiments and their interpretation, and the evaluation of a few selected nuclear data.
- 2.7 The Committee sees no point in a further distinction between ESIS and INDAC activities and recommends that they are presented as a single programme point.
- 2.8 The Committee considers that for the timely fulfillment of these activities it would be highly desirable to rely on a manpower of the order of 15 people.
- 2.9 In order to ensure that the programme in this area be most efficient and well coordinated with the national programmes it is considered important that it should be covered by an appropriate ACPM, with a composition ensuring the adequate technical background.

Ispra, 27/28 January 1976



### 3. PROJECT : TRAINING AND EDUCATION

#### 3.1. BACKGROUND

The programme "Training and Education is part of the pluriannual programme 1973/76 and has as its aim the organisation of training courses for people outside the Commission. The first courses were held in autumn 1974, and during 1975 ten courses of total duration 13,5 weeks were organised. About 250 people attended and the total fees received were 40 K.U.A.

The experience of 1974 and 1975 has shown :

- there exists an interest from industrial and state organizations in courses offered by the Ispra Establishment
- the running expenses, including publicities , invited speakers expenses etc, are covered by the receipts from fees.

One of the recognized roles of the Commission is that of education : indeed a special division within Directorate C of the General Directorate for Research, Science and Education has been created to this purpose.

In addition the Commission is also concerned with providing relationships with developing countries. With this in mind and also with the aim of helping the Commission services, the J.R.C. has organized training courses for people outside the Commission for many years.

Besides, the courses do give the Ispra Establishment the opportunity to disseminate information on its own activities.

#### 3.2. TECHNICAL DESCRIPTION

It is proposed to :

- organize courses on topics for which there is a sufficient in-house competence for lecturing. Speakers from other research centres, universities and industry will also be invited to participate as necessary
- adapt the courses for people of university degree standard.

The subjects for the courses will be chosen from the area of the activities of the future pluriannual programme :

- Nuclear Energy
- Non-electrical Applications of Nuclear Energy
- New Forms of Energy
- Environment and Ressources

and eventually from the fields

- Reference and Standard Materials
- Service Activities

It is intended to organise about 25 course weeks per year with approximate 50 % participation of Ispra staff members as lecturers.

### 3.3. MANPOWER AND COSTS

PROGRAMME : SERVICE AND SUPPORT ACTIVITIES				
PROJECT 3 : TRAINING AND EDUCATION				
	1977	1978	1979	1980
RESEARCH STAFF	5	5	5	5
INVESTMENTS (K.U.A.)	-	-	-	-
RUNNING COSTS (K.U.A.)	60	60	60	60
CONTRACTS (K.U.A.)	-	-	-	-
RESOURCES (K.U.A.)	30	30	30	30
EXPECTED INCOME (K.U.A.)	10	10	10	10

Note : Obviously the total manpower is spread over many staff.

#### 4. PROJECT : SAFEGUARDS

##### 4.1. BACKGROUND

A special task of control in the field of fissile materials has been entrusted within the Commission to the Safeguards Directorate, which is a part of the General Directorate Energy (GD XVII).

In view of its technical competence as well as of the guarantee of the independance of judgement that it can offer, the JRC is providing the necessary R&D support to the activities of the Safeguards Directorate.

The activity of the Joint Research Centre is co-ordinated with similar work carried out by national organizations in the framework of the European Safeguards R&D Association (ESARDA).

The secretariat of the Association is held by the JRC Ispra.

In the framework of the current research programme, considerable support has already been given to the Safeguards Directorate. Due to the large number of technical problems to be solved for the implementation of its tasks, the Safeguards Directorate has requested the JRC to maintain support for the coming years. Consequently this activity is presented as a special topic of the next pluriannual programme.

##### 4.2. TECHNICAL DESCRIPTION

This support of the JRC lies in particular in the following areas :

1. Control Systems
2. Measurement Techniques
3. Surveillance Techniques
4. Special Problems in the Reprocessing Plants.

Most of the activity will be carried out at the Ispra Establishment with a contribution by the Transuranium Institute (Karlsruhe Establishment of the JRC).

##### 4.2.1. Control Systems

Most of the activity will be directed to supporting the Safeguards Directorate in fundamental work for the preparation of the facility attachments and their actual implementation in the plants. Studies of the nuclear plants, evaluation of different control procedures and statistical studies will be required. The problems related to physical inventory taking and verification will be particularly investigated.

#### 4.2.2. Measurement Techniques

Most of the activity will be directed to supporting the Safeguard Directorate in the application of non-destructive techniques. The non-destructive techniques, mainly based on neutron and gamma measurements, are particularly important for the fissile material determination in finished fuels and heterogeneous materials (scraps and waste) which cannot be subjected to classical chemical analysis.

Support will be given in the following areas :

- Evaluation of the measurement methods used by plant operators.
- Adaption of existing techniques to specific problems of the Safeguards Directorate.
- Preparation of special instrumentation and its maintenance.
- Advice in the field of instrumentation.
- Training of personnel in the use of non destructive assay techniques.
- Definition and preparation of standards.
- Definition of procedures to be applied in non destructive measurements.

Support will be also given in the field of analytical chemistry techniques, mainly for the implementation of sampling techniques and for the evaluation of analytical procedures used by plant operators.

Support is also foreseen for the execution of routine analyses.

#### 4.2.3. Surveillance Techniques

In the framework of safeguards, surveillance techniques include sealing and identification techniques, cameras and television circuits. The application of these techniques makes possible a considerable reduction in the inspection effort.

The support will be mainly given in the field of sealing and identification techniques. The identification technique, developed at Ispra, is based on the detection, by ultrasonic investigation, of random distribution of inclusions or defects in different matrices.

The proposed activities concern support on the application of seals to different safeguards problems, the improvement of the ultrasonic instrumentation used for seal identification, the automation of ultrasonic data treatment, the study of new applications of seals, and the use of ultrasonic techniques for surveillance in place of cameras and television.

#### 4.2.4. Special problems in Reprocessing Plants

The activities will be oriented to solving some problems specific to this type of installation, such as :

- Calibration of input tanks
- Sampling representativity and storage
- Plutonium plating
- Destructive analysis of waste streams
- Dynamic inventories.

#### 4.3. MANPOWER AND COSTS

PROGRAMME : SERVICE AND SUPPORT ACTIVITIES				
PROJECT 4 : SAFEGUARDS				
	1977	1978	1979	1980
RESEARCH STAFF	19	19	19	19
INVESTMENTS (K.U.A.)	-	-	-	-
RUNNING COSTS (K.U.A.)	150	150	150	150
CONTRACTS (K.U.A.)	-	-	-	-
RESOURCES (K.U.A.)	100	100	100	100
EXPECTED INCOME (K.U.A.)	5	5	5	5

## 5. PROJET : TECHNICAL EVALUATIONS IN SUPPORT TO THE COMMISSION ' ACTIVITIES

### 5.1. BACKGROUND

Applied systems analysis techniques which firstly evolved from studies on large military systems in the USA have been in a rapidly growing state of development and are now used in various fields, particularly in the technological field and for the analysis of the relationships of technology with environment and society.

The importance of applied systems analysis is acknowledged worldwide e.g. by the creation of an "International Institute for Applied Systems Analysis" (IIASA), in Vienna at the United Nations level.

In Europe applied systems analysis was introduced after a considerable delay. Among the Institutions with major interests in this field, the following are to be noted: Harwell Research Centre, University of Sussex (SPRU), University of Grenoble, the nuclear centres of Karlsruhe and Jülich, Zentrum Berlin für Zukunftsforschung, the Politecnico in Milan, the Battelle Institute Geneva.

At the Ispra Establishment some systems analysis studies have been done in the past few years within the frame of the Environment Protection, Reactor Safety, Raw Material Recycling and Fissile Material Control programmes and in support to the Commission activities. In particular technico-economical evaluations have been done on reactor fuel cycles and other energy related topics, strategy studies for the power plant installation policy, modelling of the Community energy system and modelling of several physical and technological systems.

A considerable part of the activities above has been performed upon request of various General Directorates of the Commission in Brussels. In fact, one of the tasks of the Commission services is to study the Community policy in various sectors, to forecast developments, to indicate targets. This is especially true for the industrial, scientific and technological policy, for the energy policy, for the policy on the environment and for the regional policy. In these fields it is desirable that a systematic frame and some tools for the analysis are available, to enable the Commission to get the right overview of the necessary information and to evaluate the collected data.

For this purpose system analysis is helpful. It will allow to study the structure of the system in hand, to collect the relevant data and to forecast the consequences that various policies may induce. Techniques such as computer modelling and data handling, system optimization and simulation techniques, decision analysis, cost benefit studies and technical assessments are valuable tools for the purpose. The JRC can execute these analyses in various fields, having in its Ispra establishment both the multidisciplinary competence's for performing the assessment work and the specific competences for treating the data obtained by the systems analysis techniques. Good reasons may be advocated for this activity to be performed in the JRC rather than elsewhere. Although technical assessment work can be performed for the Commission by several specialized institutes of the member countries and is indeed often done through contracts assigned by the various Commission services, the JRC has the unique characteristic of being an internal, permanent, independent technical adviser for the Commission.

The JRC can on the one hand , digest compare and put under a European point of view information collected and work produced mainly on a national basis, on the other hand it can ensure that methods and techniques made available by contracts with external institutes are understood and kept available at any time after the end of the contract. This is particularly important for all the studies required to support the Commission services in elaborating the various sectorial policies. In this case the work has to be periodically updated and data and techniques kept permanently at the disposal of the Commission. The action of the JRC as technical support for the Communities sectorial policies does not therefore replace the work made through contracts with specialized institutes, but it is complementary to it and will often be performed in parallel and in collaboration with these institutes.

A JRC programme on "Technical evaluations in support to the Commission Activities" has been going on since the middle of 1973 within the frame of the present multiannual programme.

By the decision of the Council of Ministers on June 18, 1973, the programme is divided in two parts :

- studies in support of General Directorates by means of systems analysis techniques
- prospective studies on the evolution of electronic components for computers.

An Advisory Committee attended by representatives of the General Directorates has been set up with the task of making a periodical selection and establishing priorities among the various needs. The requests formulated up to now have exceeded by far the possibilities corresponding to the personnel allocated to the programme. The subjects ranged from various sectors of industry, to the energy field and to the environment; the potential usefulness of the JRC system analysis support activity was also recognized for other fields as regional development , transport, agriculture, etc. A first choice had therefore to be made, taking into account the following main criteria.

Whenever possible, some convergency of the interests of the various General Directorates has been sought; the possibility of harmonizing the work done in this programme with that being performed within the frame of other JRC research programmes has been considered; the opportunity of coupling the short or medium term jobs with longer term developments in order to provide some continuity and some basic general support has also been taken into account. In addition, the choices have been made taking into account the priorities expressed by the General Directorates and the possibilities of performing efficient work at the JRC considering the existing competences and their possible gradual broadening.

During a first period the activity in the Programme was split in three parts: systems analysis studies, conceptual design of a fusion reactor, studies on the evolution of electronic components for computers. However, gradually the systems analysis studies took the major part of the volume of the programme and they were concentrated on two main fields : the energy field and the transport field, the latter actually essentially concerning the subjects relevant to the energy field.

Some other activities were also performed in the fields of the nuclear siting, of the environment and of the resources : these activities were partly carried out within the frame of the corresponding JRC own programmes.

## 5.2. TECHNICAL DESCRIPTION

This work is done upon specific request of the various services. It is programmed yearly by the Advisory Committee of General Directorates representatives established in 1973.

Hence, during the next programme, assessments and evaluations can be requested in many fields, and a description of activities can not be made. However, on the basis of past experience and of the requests formulated up now within the frame of the current programme, one can indicate a few main fields of activities likely to be part of the future work. The first concerns the energy field and deals with the analysis of the Community's energy system with special attention given to the nuclear sector. A second one deals with the assessment studies in the field of application of advanced informatics techniques. A third chapter deals with the problem of resources for the Community; in particular a specific study for a model of the agriculture-food industry system is foreseen. A fourth chapter includes works on environmental pollution problems, to be used as a technical background for regulations in the field.

### 5.2.1. Analysis of the Community's energy system

As a continuation of the support given until now to the General Directorate for Energy (DG XVII) for the elaboration of the Nuclear Target Programme for the European Community, to be periodically established according to art. 40 of the EURATOM Treaty, assessment studies will be performed.

They will deal with the perspectives of nuclear power for electricity production, evaluating the consequences of the various policy alternatives. Non electrical uses of nuclear energy will as well be considered in order to have the correct evaluation of constraints on and consequences of the use of nuclear energy.

In particular, once the energy demand growth hypothesis and the policy to be followed for the penetration of the various energy sources are established, the fuel cycle requirements as a function of time are calculated: quantities of natural uranium and separative work, reprocessing and fabrication needs, etc. In addition, money investments and discharged wastes are also evaluated; the possible bottlenecks are determined and the influence of the timing of the decision process is assessed.

Updating and improvement of computer programs set up for the purpose is foreseen as well as the development of new calculation tools, following specific requests

The objectives of the activity is threefold :



- to provide DG XVII with calculation methods suited for a direct and easy use by the DG's services. In this way they will be able to deal themselves with day-to-day questions.
- to give advice to DG's services on more involved and long term questions concerning the technical aspects of the Communities energy policy.
- to establish periodic reference topical reports to be used as technical addenda to the Target Programme.

The above activity has a permanent periodic nature, linked to the Target programme publications. In addition and to satisfy as well the requests of the General Directorates for Industry (DG III), for Transport (DG VII) and for Research, Science and Education (DG XII) a broadening of the field is possible.

If deemed useful to have an overall energy assessment similar to the one undertaken for the Target programme for nuclear energy, a support similar to the one mentioned above for nuclear energy will be requested for the other energy sectors, thus implying methods to be established and assessments to be performed for a larger field encompassing the overall energy system.

By the end of 1976 a model based on an energy flow scheme will be operational at the JRC Ispra. It will allow the calculation of the energy balances at various levels up to the primary sources, for a given demand at the consumption level. Time dependent effects such as delays and stock variations, will be included. Starting from this the work of the JRC-Ispra shall be programmed, both for the content and the timing, in such a way as to progress in parallel with the indirect action on energy modelling lead by DG XII. A direct collaboration with the various national institutes engaged in the research is foreseen and in particular the various achievements of the indirect action will be used and in some cases directly incorporated in the JRC model.

The space dependent problems of the energy system have also to be considered to some extent in order to evaluate fully the consequences of the various policy choices. In particular they are concerned with the regional distribution of the sites for power plants and fuel cycle facilities and with the transport of the various energy carriers and of the wastes. Models of the various energy transport systems have to be elaborated in order to evaluate the impact of the various alternatives on the overall system.

#### 5.2.2. Evaluation of advanced applications of informatics

Advanced informatics techniques may be of great importance in several fields. The Commission services, in elaborating proposals for sectorial policies of the Community, needs advice and assessments concerning the feasibility and the impact of the various applications.

It is proposed to perform these analyses upon request, on the basis of the experience available at the JRC.

### 5.2.3. System Studies on Renewable and non Renewable Resources

problems of renewable and not renewable resources will be treated by the help of computer models in order to provide information on the consequences on the resource available of various policies. Alternative industrial managements of the resources such as recycling and/or substitution, will be considered; the importance of consumption rates and cost levels will be assessed.

A particular effort under this heading will be made in the elaboration of a model for the agricultural-food industry system which is of interest to the General Directorates for Agriculture (DG VI) and for Industry (DG III).

The aim of the work is to develop and implement a mathematical model which describes the "agriculture food industry" system in the CEE, as a tool for the management of the agricultural resources of the Community (short and long term evolution).

The system is considered at a low level of aggregation, so as to represent in detail the complex correlations among its sectors.

The first phase of the work consists in establishing a scheme of the flux of products (measured in physical units), which defines the structure of the system in stationary conditions, by means of "input coefficients" (normalized input-output ratios) characterizing each technology and "input-output" matrices based on the Leontiev formalism.

The main features of this phase are : the choice of the criteria for homogeneous and effective classification (technologies grouped into industries in turn associated into characteristic sectors), the accurate description of the intercorrelations in the presence of a large number of recycles and feedbacks, as well as the collection and consistency testing of a large body of data.

The main source of data will be the OSCE in Luxemburg; the data should be compared, complemented and harmonized with information derived from National Organizations; for some sectors it can be also foreseen that data provided by advanced direct detection methods will be used (e.g.: teledetection of earth resources by instrumentation on aircraft).

In the second phase of the work the code describing the flux diagram of the system will be made operational, through the inclusion of time-dependent parameters as a lag in product flow, stock variation, etc.

System simulation and optimization as well as decision analysis techniques will be used to implement the ability of the model to describe propagation of output variable perturbations through the system, according to various products flow policies subjected to the appropriate constraints.

A complementary application of the static model for the system is foreseen within the frame of the study on the propagation of heavy metal pollution from soil to man proposed in the programme "Environment and Resources".

A considerable enlargement of the usefulness and range of application of the model would be obtained by coupling to the products flow-diagram a cost analysis, converting the material balance into value terms. Since this development implies a large increase in the complexity of the global model, as well as a sound basis in economics, it should be preceded by an extensive feasibility study, to set the actual validity and practical limits of such an extended model. A part of this study might be the elaboration of test models for a single sector of the system of appropriate relevance. When required, economic background and support will be provided through contracts with specialized organizations and by consulting experts in the field.

#### 5.2.4. Assessments Studies on Pollution Problems

In support to the activity of the "Environment and Consumer Protection Service" two kinds of study are requested to back-up the Commission environmental policy :

- computer simulation of pollutant propagation in physical systems
- assessment of the technical aspects of the discharge of specific pollutants and study of the consequences of possible regulations.

Examples of the first kind of studies performed in the present programme are the analysis of the mercury pathway by a dynamic simulation program and the model for the management of the water quality in a river using mathematical optimization techniques. An example of the second kind of study is the assessment of the pollution problems of paper industry including the analysis of the economic consequences of possible regulations.

Similar studies will be requested in the future, concerning other pollutants and other industries. They will be carried out and planned on the basis of the manpower available at the JRC and will be largely integrated by the activities performed by national organizations under contract of the Environment and Consumer Protection Service. The role of the JRC Ispra will, in some cases, be important in order to ensure continuity and interconnection among the various studies and in particular to make the calculation methods obtained through the contracts really be, and remain, available to the Commission.

### 5.3. PLANNING

As indicated before the details of the work have to be established by the Advisory Committee of General Directorates representatives at the beginning of each year on the basis of the requests formulated by the Commission services.

However, it can be anticipated for the "Analysis of the Community's energy system" that in the first two years some models and computer programs for sectorial systems will be developed, together with updating and improving the TOTEM computer program. In the second part of the programme, TOTEM will be coupled with the models of sectorial systems, or a complete new model will be developed.

For the general energy model of the Community, in the first two years the attention will be focused on three points : simulation of conversion plants, the study of various constraints, the study of the space dependent aspects. Later the effort will be shifted to the study of the sectorial optimizations and the feedback loops and to the connection with the economic system.

In parallel, assessment studies will be done all the time by using the most updated available tools.

In the elaboration of the model of the agricultural food industry system the main phases of the work are :

- |                                      |           |
|--------------------------------------|-----------|
| - flux diagram for stationary system | 1977-1978 |
| - data collection and harmonization  | 1978-1979 |
| - time dependent model               | 1978-1980 |
| - extended model (cost analysis)     | 1979-1980 |

MANPOWER AND COSTS

PROGRAMME : SERVICE AND SUPPORT ACTIVITIES

PROJECT 5 : TECHNICAL EVALUATIONS IN SUPPORT TO THE COMMISSION

	1977	1978	1979	1980
RESEARCH STAFF	13	13	13	13
INVESTMENTS (K.U.A.)	-	-	-	-
RUNNING COSTS (K.U.A.)	10	10	15	15
CONTRACTS (K.U.A.)	25	25	25	25
RESOURCES (K.U.A.)	TOTALLY FUNDED BY THE GENERAL BUDGET OF THE COMMISSION			
EXPECTED INCOME (K.U.A.)	-	-	-	-