

ASSESSMENT OF INDIRECT AND CUMULATIVE IMPACTS AS WELL AS IMPACT INTERACTIONS

Volume 3: Guidelines



EUROPEAN
COMMISSION

A great deal of additional information on the European Union is available on the Internet.
It can be accessed through the Europa server (<http://europa.eu.int>).

Cataloguing data can be found at the end of this publication.

Luxembourg: Office for Official Publications of the European Communities, 2000

Volume 3: ISBN 92-828-8047-8

Volumes 1–3: ISBN 92-828-8048-6

© European Communities, 2000

Reproduction is authorised provided the source is acknowledged.

Printed in Belgium

Guidelines for the Assessment of Indirect and Cumulative Impacts as well as Impact Interactions

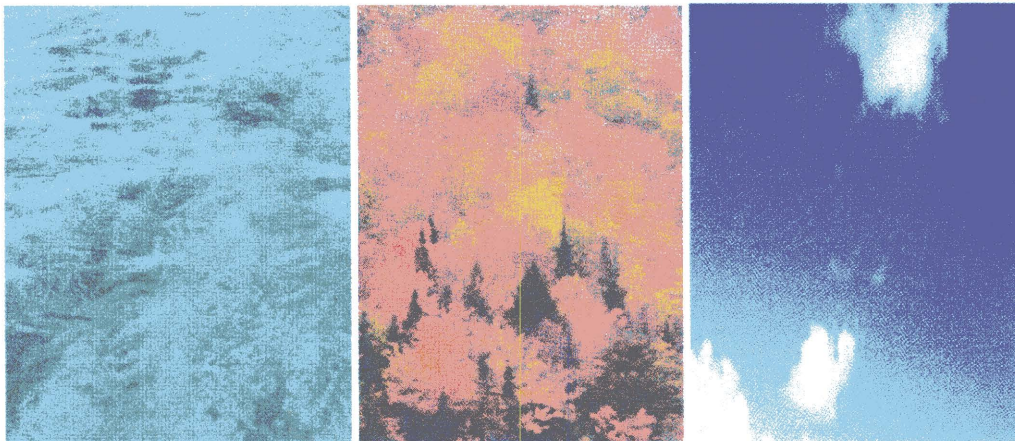

MAY 1999

NE80328/D1/3

EC DG XI

Environment, Nuclear Safety & Civil
Protection

Guidelines for the Assessment of Indirect and Cumulative Impacts as well as Impact Interactions

Author	L J WALKER	<i>L.J. Walker</i>
	J JOHNSTON	
Checker	H NAPIER	<i>pp FM Russell</i>
Approver	D CLARK	<i>[Signature]</i>

NE80328/D1/3

May 1999

This report has been prepared for in accordance with the terms and conditions of The European Commission contract, dated 30/12/96. Hyder cannot accept any responsibility for any use of or reliance on the contents of this report by any third party.

Hyder 

PREFACE

These Guidelines consider *The Assessment of Indirect and Cumulative Impacts as well as Impact Interactions* within the Environmental Impact Assessment (EIA) process. The study has been commissioned by the European Commission: Directorate-General XI (Environment, Nuclear Safety and Civil Protection). It presents the results of research and consultations conducted by Hyder, in the form of guidelines which advise practitioners of EIA on the often complicated issues of cumulative and indirect impacts, as well as impact interactions. The Guidelines give advice on how to approach these kinds of impacts during the various stages of EIA, how to adapt the approach to a specific project and suggests methods and tools for identifying and assessing indirect and cumulative impacts, as well as impact interactions.

EXECUTIVE SUMMARY

Introduction

These Guidelines consider the Assessment of Indirect and Cumulative Impacts as well as Impact Interactions within the Environmental Impact Assessment (EIA) process. It presents the results of research and consultations conducted by Hyder, commissioned by the European Commission: Directorate-General XI (Environment, Nuclear Safety and Civil Protection).

These Guidelines are intended for use by the Environmental Impact Assessment (EIA) practitioner and developer. The aim is to provide guidance on practical methods and approaches to assess indirect and cumulative impacts of a project as well as impact interactions. The Guidelines are not intended to be formal or prescriptive but are designed to assist EIA practitioners in developing an approach which is appropriate to a project, and to consider these impacts as an integral part of the EIA process.

Although these guidelines are primarily addressing the EIA at the project level, the reader interested in the assessment of indirect and cumulative impacts as well as impact interactions at the more strategic level of plans, programmes or policies will find these guidelines useful and to a large extent applicable.

The Guidelines have been designed to apply to a wide range of projects and to assist in the EIA process throughout the Member States. They give advice on how to approach these kinds of impacts during the various stages of EIA, how to adapt the approach to a specific project and suggests methods and tools for identifying and assessing indirect and cumulative impacts, as well as impact interactions.

Including an assessment of the indirect and cumulative impacts, and interactions in an EIA is required by legislation, contributes towards sustainable development, is good practice and aids the decision making process.

Indirect and Cumulative Impacts and Impact Interactions: A Definition

A key problem identified in the study was how to define indirect and cumulative impacts and impact interactions. The definitions of these three types of impact overlap, although there are no agreed and accepted definitions. For the purposes of these guidelines, definitions have been developed:

Indirect Impacts: Impacts on the environment, which are not a direct result of the project, often produced away from or as a result of a complex pathway. Sometimes referred to as second or third level impacts, or secondary impacts.



Cumulative Impacts: Impacts that result from incremental changes caused by other past, present or reasonably foreseeable actions together with the project.

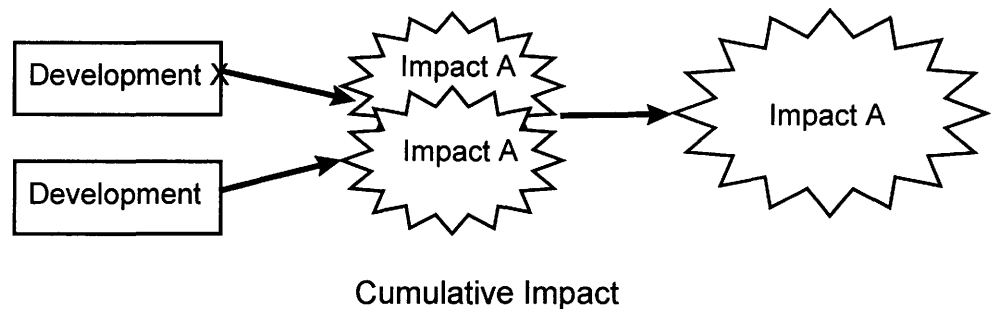

Impact Interactions: The reactions between impacts whether between the impacts of just one project or between the impacts of other projects in the areas.

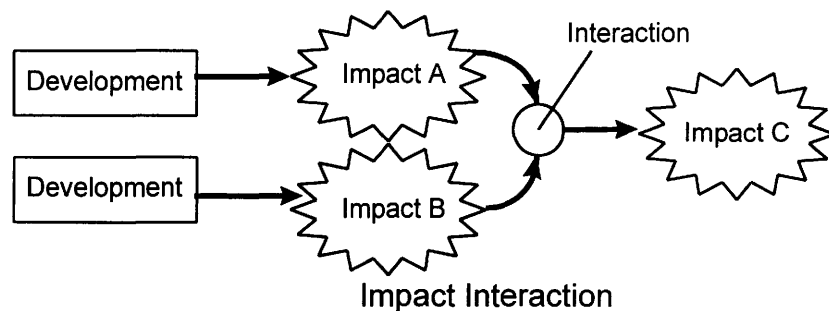

Adopting an Integrated Approach

The assessment of indirect and cumulative impacts, and impact interactions should not be thought of as a separate stage in the EIA process. Indeed the assessment of such impacts should be an integral part of all stages of the process. Establishing an appropriate project team is also of key importance.

The purpose of these Guidelines is not to recommend a single method for assessing indirect and cumulative impacts and impact interactions, but to suggest various approaches which the practitioner can adapt and combine to suit the particular project.

These Guidelines provide information on eight methods and tools which were selected from case studies and literature research. These generally fall into two groups:

Scoping and Impact Identification Techniques - these identify how and where an indirect or cumulative impact or impact interaction would occur.

Evaluation techniques - these quantify and predict the magnitude and significance of impacts based on their context and intensity.

During the EIA process it may be that a combination of techniques are used, or that approaches are adopted at different stages of the project. Examples of both categories are set out below:

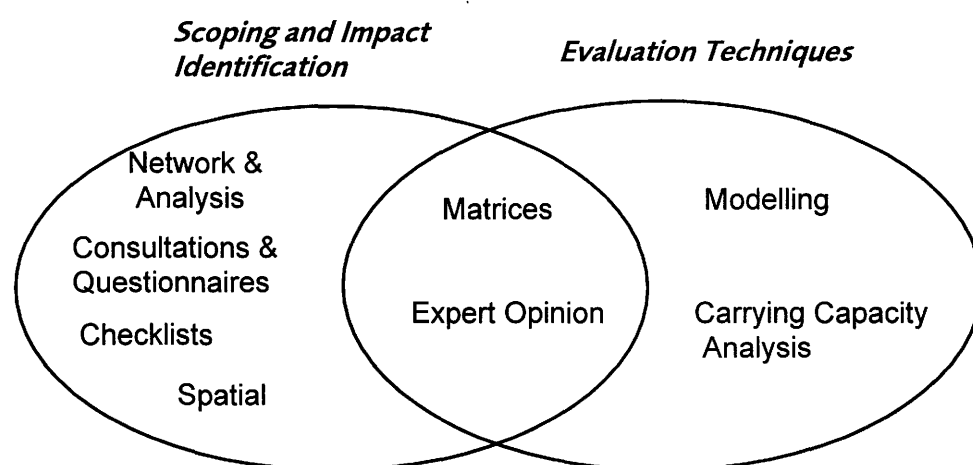

Methods and Tools for Assessment of Indirect and Cumulative Impact as well as Impact Interaction

There are a number of factors which will influence the approach adopted for the assessment of indirect and cumulative impacts and impact interactions for a particular project. The method should be practical and suitable for the project given the data, time and financial resources available. Key points to consider when choosing the method(s) include:

- the nature of the impact(s)
- the availability and quality of data
- the availability of resources (time, finance and staff)

The following table provides a summary of each of the methods contained in the Guidelines.

The diagram which follows sets out the key stages for assessing indirect and cumulative impacts as well as impact interactions.

CONSIDERATIONS IN THE IDENTIFICATION AND INDIRECT AND CUMULATIVE IMPACTS AND IMPACT

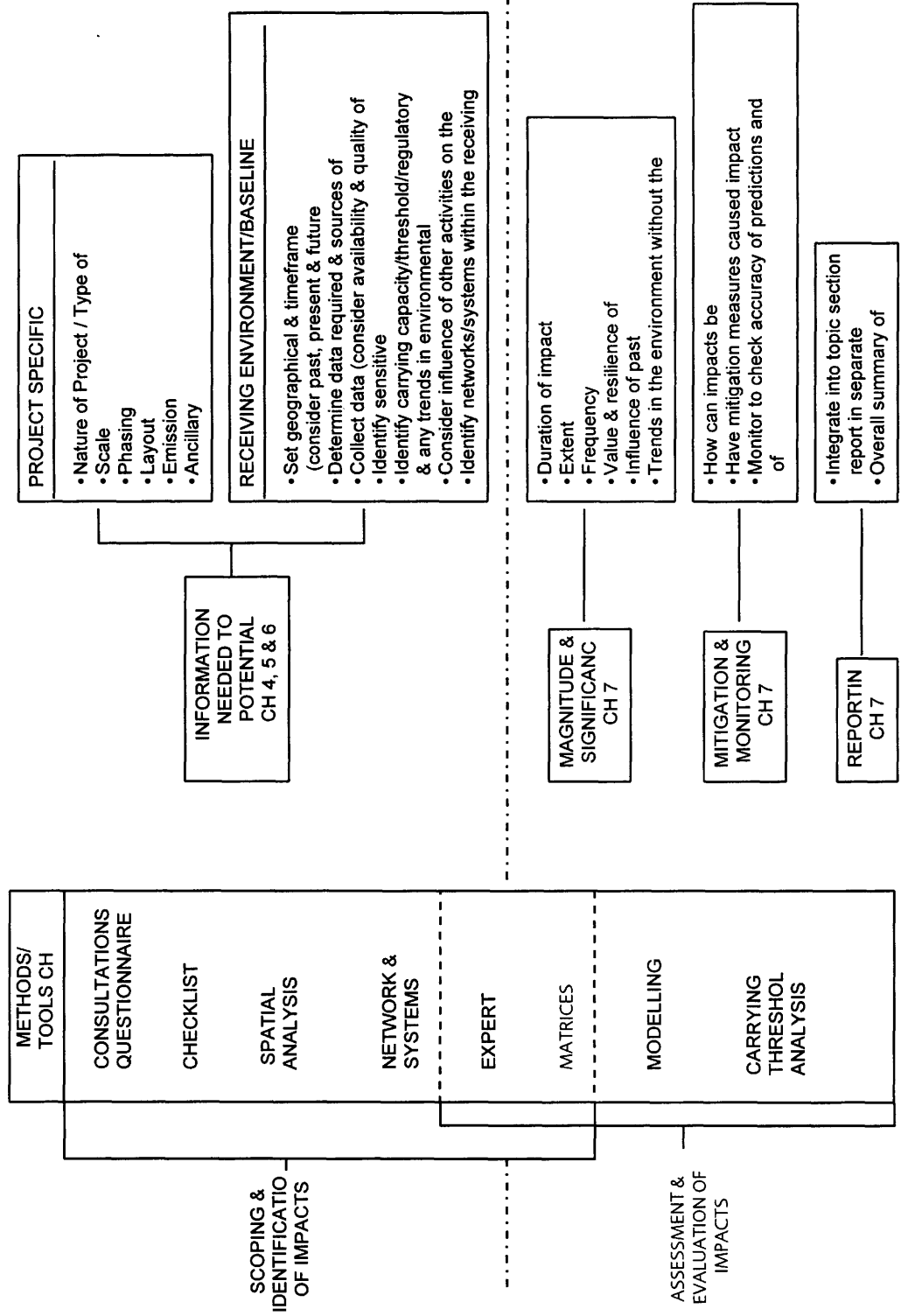

Summary of Methods for Assessing Indirect and Cumulative Impacts and Impact Interactions

Method	Description	Advantages	Disadvantages	Cumulative Impacts	Indirect Impacts	Impact Interactions	Identification	Evaluation
Expert Opinion	A means of both identifying and assessing indirect and cumulative impacts and impact interactions. Expert Panels can be formed to facilitate exchange of information of different aspects of the impacts of a project.	<ul style="list-style-type: none"> • Can consider such impacts as an integral part of the assessment. 	<ul style="list-style-type: none"> • Some specialists or experts may be remote from the main project team. 	✓	✓	✓	✓	✓
Consultations and Questionnaires	A means of gathering information about a wide range of actions, including those in the past, present and future which may influence the impacts of a project.	<ul style="list-style-type: none"> • Flexible • Considers potential impacts early on. • Can be focused to obtain specific information. 	<ul style="list-style-type: none"> • Prone to errors of subjectivity • Questionnaire can be time consuming, and risk of poor response. 	✓	✓	✓	✓	✗

Summary of Methods for Assessing Indirect and Cumulative Impacts and Impact Interactions

Method	Description	Advantages	Disadvantages	Cumulative Impacts	Indirect Impacts	Impact Interactions	Identification	Evaluation
Checklists	Provide a systematic way of ensuring that all likely events resulting from a project are considered. Information presented in a tabular format.	<ul style="list-style-type: none"> • Systematic method • Can develop 'standard' checklist for similar projects. 	<ul style="list-style-type: none"> • Can allow oversight of important effects • Nature of cause-and-effect relationships not specified. 	✓	✓	✗	✓	✗
Spatial Analysis	Uses Geographical Information Systems (GIS) and overlay maps to identify where the cumulative impacts of a number of different actions may occur, and impact interactions. Can also superimpose a project's effect on selected receptors or resources to establish areas where impacts would be most significant.	<ul style="list-style-type: none"> • GIS flexible & easy to up date. • Can consider multiple projects and past, present & future actions. • Allows clear visual presentation 	<ul style="list-style-type: none"> • GIS can be expensive & time consuming. • Difficult to quantify impacts. • Problems in updating overlays. 	✓	✗	✓	✓	✗

Summary of Methods for Assessing Indirect and Cumulative Impacts and Impact Interactions (cont.)

Method	Description	Advantages	Disadvantages	Cumulative Impacts	Indirect Impacts	Impact Interactions	Identification	Evaluation
Network and Systems Analysis	Based on the concept that there are links and interaction pathways between individual elements of the environment, and that when one element is specifically affected this will also have an effect on those elements which interact with it.	<ul style="list-style-type: none"> Mechanism of cause and effect made explicit. Use of flow diagrams can assist with understanding of impacts. 	<ul style="list-style-type: none"> No spatial or temporal scale. Diagrams can become too complex. 	✓	✓	✓	✓	✗
Matrices	A more complex form of checklist. Can be used quantitatively and can evaluate impacts to some degree. Can be extended to consider the cumulative impacts of multiple actions on a resource.	<ul style="list-style-type: none"> Provides a good visual summary of impacts. Can be adapted to identify and evaluate to some degree indirect & cumulative impacts and impact interactions. Matrices can be weighted/ impacts ranked to assist in evaluation. 	<ul style="list-style-type: none"> Can be complex and cumbersome to use. 	✓	✓	✓	✓	✓

Summary of Methods for Assessing Indirect and Cumulative Impacts and Impact Interactions (cont.)

Method	Description	Advantages	Disadvantages	Cumulative Impacts	Indirect Impacts	Impact Interactions	Identification	Evaluation
Carrying Capacity Analysis	Based on the recognition that thresholds exist in the environment. Projects can be assessed in relation to the carrying capacity or threshold determined, together with additional activities.	<ul style="list-style-type: none"> Addresses accumulation of impacts against thresholds. Considers trends in the environment. 	<ul style="list-style-type: none"> Limited to data available. Not always able to establish the threshold or carrying capacity for a particular resource or receptor. 	✓	✓	✗	✗	✓
Modelling	An analytical tool which enables the quantification of cause-and-effect relationships by simulating environmental conditions. This can range from air quality or noise modelling, to use of a model representing a complex natural system.	<ul style="list-style-type: none"> Quantifies cumulative effects Geographical and time-frame boundaries are usually explicit Addresses specific cause-and-effect relationships 	<ul style="list-style-type: none"> Often requires large investment of time and resources Can be difficult to adapt some models to a particular project. Depends on baseline data available. 	✓	✓	✓	✗	✓

Scoping

The general principles of scoping can be readily applied to the assessment of indirect and cumulative impacts as well as impact interactions. Throughout the various stages of the scoping exercise it is important for the practitioner to be conscious of the need to address such impacts.

Important factors which need to be considered when scoping the proposed assessment of indirect and cumulative impacts and impact interactions is the setting of the geographical or 'spatial' boundary and the temporal or 'time frame' boundary. Indirect and cumulative impacts as well as impact interactions may well extend beyond the geographical site boundaries of the project. Consideration should also be given to historical or potential future impacts. Mapping the geographical and time boundaries can be a useful tool to show areas of potential overlap and therefore where indirect and cumulative impacts as well as impact interactions may occur.

When considering baseline data an important factor will be to determine if additional data needs to be collected to allow assessment of indirect and cumulative impacts and impact interactions.

Standard scoping methods can be adapted to allow for the consideration of indirect and cumulative impacts as well as impact interactions. Suitable tools for the identification of such impacts are:

- checklists
- consultations
- mapping overlay
- network and systems analysis

The scoping exercise will identify the potential impacts considered to be significant and which require further assessment. At this point in the EIA it will be necessary to decide which 'tools', techniques or methods will be used to assess and evaluate the significance of the impacts

Information Needed For the Assessment: The Project

In order to enable the potential indirect and cumulative impacts and impact interactions to be identified and assessed, detailed information on the proposed development should be obtained. The key characteristics of the project will be important in influencing such impacts. This may include information on project phasing, the scale of the project, the site layout, emissions to land, air and water, ancillary development and proposed mitigation measures.

Information Needed for the Assessment : The Receiving Environment

Particular attention needs to be given to defining the baseline conditions of the affected environment. These baseline conditions then provide the context for evaluating the environmental impact of a project, and therefore the indirect and cumulative impacts as well as impact interactions.

The database required to assess indirect and cumulative impacts as well as impact interactions is likely to be extended in comparison to the information collected for direct impacts in terms of the geographical and time boundaries. The important factor will be to identify data requirements early on in the assessment process and to consider how the data will be used to assess indirect and cumulative impacts as well as impact interactions before the data collection process begins.

Data collection should be focused on determining the current and future status of the environmental resource, historical trends, existing regulatory standards and development plans and programmes. Determining the carrying capacity or resource threshold can also assist in assessing the significance of indirect and cumulative impacts as well as impact interactions.

Assessing the Impacts - An Overview

Once the impacts have been identified the next step will be to ascertain the magnitude of the impacts and their significance. Establishing significance criteria for indirect and cumulative impacts as well as impact interactions may be more complex than for direct impacts.

Consideration will need to be given to appropriate mitigation measures for indirect and cumulative impacts as well as impact interactions. In addition it should be recognised that indirect and cumulative impacts and impact

interactions can be caused by mitigation measures themselves, resulting in 'impact shifts'.

The assessment of indirect and cumulative impacts as well as impact interactions is an iterative process in which the potential for such impacts is re-examined through all stages of the project.

As with Environmental Assessment in general, there are often uncertainties and problems when assessing indirect and cumulative impacts and impact interactions. Any assumptions used in the assessment should therefore be documented.

The results of the assessment of indirect and cumulative impacts and impact interactions need to be reported in the Environmental Statement either by integrating the assessment into each topic section or by producing a separate chapter. Use of summary tables and figures should also be considered which may be more easily understood by the decision maker and public.

ACKNOWLEDGEMENTS

Thanks are given to the following organisations for their helpful assistance in the compilation of this report.

Euronet, Bristol, UK

VTT Communities and Infrastructure, Helsinki, Finland.

Soil and Water, Helsinki, Finland.

SITO, Helsinki, Finland.

Euroconsultants S.A., Thessalonika, Greece.

Professor Papachristou, Aristotle University of Thessalonika, Greece.

Paraskevopoulos & Geordiadis Ltd., Athens, Greece.

Froelich & Sporbeck, Bochum, Germany.

Bundesanstalt für Gewässerkunde, Koblenz, Germany.

Herr Edmund Spindler, Hamm, Germany.

Alan Busse, Envirotec, London, UK.

Ove Arup & Partners, Edinburgh and London, UK.

Agri pro, Lisbon, Portugal.

National Power, Coventry, UK.

CONTENTS

1. INTRODUCTION	1
1.1 OBJECTIVE OF THE GUIDELINES	1
1.2 LEGISLATION	2
1.2.1 <i>Environmental Impact Assessment</i>	2
1.2.2 <i>Integrated Pollution Prevention and Control</i>	3
1.3 BACKGROUND TO THE RESEARCH FOR PRODUCTION OF THE GUIDELINES	4
1.4 STRUCTURE OF THE GUIDELINES	4
2. BACKGROUND TO INDIRECT AND CUMULATIVE IMPACTS AND IMPACT INTERACTIONS	6
2.1 INDIRECT AND CUMULATIVE IMPACTS AND IMPACT INTERACTIONS: A DEFINITION	6
2.1.1 <i>Cross Media Impacts</i>	8
2.2 WHY ASSESS INDIRECT AND CUMULATIVE IMPACTS AND IMPACT INTERACTIONS?	8
2.2.1 <i>Introduction</i>	8
2.2.2 <i>Towards Sustainable Development</i>	9
2.2.3 <i>Good Practice</i>	9
2.3 INTEGRATING ASSESSMENT OF INDIRECT AND CUMULATIVE IMPACTS AND IMPACT INTERACTIONS INTO THE PROJECT	10
2.3.1 <i>Adopting an Integrated Approach</i>	10
2.3.2 <i>The Project Team</i>	11
2.3.3 <i>The Project Co-ordinator</i>	11
2.3.4 <i>Project Co-ordination Group</i>	12
2.4 SUMMARY	13
3. METHODS AND TOOLS	14
3.1 INTRODUCTION	14
3.2 SELECTING THE 'TOOLS' AND METHODS FOR THE PROJECT	20
3.3 EXPERT OPINION	20
3.3.1 <i>Introduction</i>	20
3.3.2 <i>Advantages and Disadvantages</i>	21
3.3.3 <i>Application of the Method</i>	21
3.3.4 <i>Case Studies</i>	22
3.4 CONSULTATIONS AND QUESTIONNAIRES	22
3.4.1 <i>Introduction</i>	22
3.4.2 <i>Advantages and Disadvantages</i>	23
3.4.3 <i>Application of the Method</i>	24
3.4.4 <i>Case Studies</i>	24
3.5 CHECKLISTS	26
3.5.1 <i>Introduction</i>	26
3.5.2 <i>Simple Impact Identification Checklist</i>	27
3.5.3 <i>Descriptive Checklists</i>	28
3.5.4 <i>Geographical or Receptor Based Checklist</i>	28
3.5.5 <i>Advantages and Disadvantages</i>	29
3.5.6 <i>Application of Method</i>	29
3.5.7 <i>Case Studies</i>	30

3.6 SPATIAL ANALYSIS: OVERLAY MAPPING AND GEOGRAPHICAL INFORMATION SYSTEMS (GIS)	36
3.6.1 Introduction	36
3.6.2 Advantages and Disadvantages	36
3.6.3 Application of the Method	37
3.6.4 Case Studies	38
3.7 NETWORK AND SYSTEMS ANALYSIS	39
3.7.1 Introduction	39
3.7.2 Impact Chains	40
3.7.3 Advantages and Disadvantages	41
3.7.4 Application of the Method	41
3.7.5 Case Studies	42
3.8 MATRICES	47
3.8.1 Introduction	47
3.8.2 Simple Matrices	47
3.8.3 Weighted Matrices	48
3.8.4 Stepped Matrices	49
3.8.5 Advanced Network Matrices	51
3.8.6 Advantages and Disadvantages	51
3.8.7 Application of the Method	52
3.9 CARRYING CAPACITY OR THRESHOLD ANALYSIS	53
3.9.1 Introduction	53
3.9.2 Trends Analysis	54
3.9.3 Advantages and Disadvantages	55
3.9.4 Application of Method	55
3.9.5 Case Studies	56
3.10 MODELLING	57
3.10.1 Introduction	57
3.10.2 Air Quality Modelling	57
3.10.3 Water Quality Modelling	58
3.10.4 Noise Modelling	58
3.10.5 Ecological Modelling	58
3.10.6 Visual Modelling	59
3.10.7 Advantages and Disadvantages	59
3.10.8 Application of the Method	59
3.10.9 Case Studies	60
4. SCOPING.....	63
4.1 INTRODUCTION	63
4.1.1 The Importance of Scoping	63
4.1.2 The Importance of Consultation	63
4.1.3 The Requirement for Scoping	63
4.1.4 Scoping for Indirect and Cumulative Impacts, and Impact Interactions	64
4.2 THE SCOPING PROCESS	64
4.2.1 Setting the Boundaries or 'Limits' for the Assessment	64
4.2.2 Mapping the Boundaries	67
4.2.3 Collecting the Baseline Data	68
4.2.4 Consideration of Alternatives	68
4.2.5 Identifying the Impacts	69
4.2.6 The Way Forward – Assessing the Impacts	70

4.3 SUMMARY	70
5. INFORMATION NEEDED TO ASSESS THE IMPACTS: THE PROPOSED PROJECT	73
5.1 BACKGROUND	73
5.2 INFORMATION CONCERNING THE PROJECT	73
5.2.1 <i>The Nature of the Project</i>	73
5.2.2 <i>Project Phasing</i>	74
5.2.3 <i>Scale of the Project</i>	74
5.2.4 <i>Site Layout</i>	75
5.2.5 <i>Emissions to Air, Water and Land</i>	75
5.2.6 <i>Ancillary Development</i>	76
5.2.7 <i>Proposed Mitigation Measures</i>	77
5.3 SUMMARY OF ITEMS TO CONSIDER	78
6. INFORMATION NEEDED FOR THE ASSESSMENT: THE RECEIVING ENVIRONMENT... 79	79
6.1 BACKGROUND	79
6.2 DEFINING THE BOUNDARIES OF THE ASSESSMENT AND BASELINE CONDITIONS	79
6.2.1 <i>Setting the Boundaries - the Need for Review</i>	79
6.2.2 <i>Trans-Boundary Impacts</i>	80
6.3 COLLECTING DATA	80
6.3.1 <i>Determining Data Requirements</i>	80
6.3.2 <i>Data Sources</i>	81
6.3.3 <i>Using Indices</i>	82
6.3.4 <i>Identifying Sensitive Receptors</i>	82
6.3.5 <i>'Carrying Capacity', Resource Thresholds and Stress Factors</i>	82
6.3.6 <i>Trends</i>	83
6.3.7 <i>Regulatory Standards</i>	83
6.4 THE INFLUENCE OF OTHER ACTIVITIES	84
6.5 SUMMARY OF ITEMS TO CONSIDER	84
7. ASSESSING THE IMPACTS - AN OVERVIEW	86
7.1 INTRODUCTION	86
7.2 SCOPING – AN ONGOING PROCESS OF REVIEW	86
7.3 MAGNITUDE AND SIGNIFICANCE OF THE IMPACT	86
7.3.1 <i>Introduction</i>	86
7.3.2 <i>Modelling</i>	87
7.3.3 <i>Matrices</i>	88
7.3.4 <i>Carrying Capacity and Threshold Analysis</i>	88
7.4 MITIGATION	88
7.5 MONITORING	89
7.6 PROBLEMS AND UNCERTAINTIES	89
7.6.1 <i>Boundaries</i>	89
7.6.2 <i>Baseline Conditions</i>	89
7.6.3 <i>Understanding Interactions and Pathways</i>	90
7.6.4 <i>Assumptions</i>	90
7.7 REPORTING	90
7.7.1 <i>Use of Tables</i>	90
7.7.2 <i>Use of Schematic Diagrams</i>	90

7.7.3 Other Methods	91
7.7.4 Avoidance of Double Counting	91
7.8 SUMMARY	91

LIST OF FIGURES

Figure 2.1	Flow Diagram Illustrating Direct Impacts
Figure 2.2	Flow Diagram Illustrating Cumulative Impacts
Figure 2.3	Flow Diagram Illustrating Impact Interactions
Figure 2.4	How the Assessment of Cumulative and Indirect Impacts, as well as Impact Interactions can apply to Various Stages of the EIA Process
Figure 2.5	The Project Team
Figure 3.1	Methods and Tools for Assessment of Indirect and Cumulative Impacts as well as Impact Interactions
Figure 3.2	The compilation of an overlay map from various component maps
Figure 3.3	An Example of how Impact Chains can be Used to Illustrate Wider Impacts and Impact Interactions
Figure 3.4	Systems of Interactions: Effects of Channel Widening on Water Quality (Bundesanstalt fur Gewasserkunde)
Figure 3.5	Method Stages Used for Spatial and Network Analysis of Ecosystem
Figure 3.6	An advanced Stepped Matrix used for a Hypothetical Port Development (Adapted from Sorenson 1971)
Figure 3.7	Regional Winter Populations of Elk in Finland Between 1973 and 1995 (Source Game and Fishing Research Institute, Finland)
Figure 3.8	Predicted Salt Deposition from Existing and Planned Cooling Towers at Killingholme Power Station (Powergen 1995)
Figure 4.1	The Selection of Geographical Boundaries for Impact Study Areas
Figure 4.2	Time Chart Illustrating Past, Present and Future Development which Could be Included when Considering the 'Time Boundary' of a Project
Figure 4.3	Flow Diagram Showing the Scoping Process and How it Can Include Cumulative and Indirect Impacts, as well as Impact Interactions
Figure 5.1	Impact Interactions, in the Form of Interaction Between Two Industrial Emissions
Figure 7.1	A Schematic Diagram

LIST OF TABLES

Table 3.1	Summary of Methods for Assessing Indirect and Cumulative Impacts and Impact Interactions
Table 3.2	Example of a Simple Checklist
Table 3.3	Example of Descriptive Checklist for a Power Station Development
Table 3.4	Checklist Used for Identifying Impacts of the Turku Central Treatment Works
Table 3.5	Table of Cumulative Effects: High Street to Glasgow Cross (from Strathclyde Crossrail Environmental Statement)
Table 3.6	Example of Simple Matrix
Table 3.7	Example of a Weighted Matrix
Table 3.8	Example of Stepped Matrix (taken from Froelich and Sporbeck)

APPENDICES

APPENDIX 1 -	METHODOLOGY.....	A1-1
APPENDIX 2 -	CASE STUDIES	
CASE STUDY A -	NESTOS RIVER PROJECT, WEST THRACE, GREECE.....	A2 -1
CASE STUDY B -	CARDIFF WASTE WATER TREATMENT WORKS, UNITED KINGDOM....	A2 -5
CASE STUDY C -	HIGHWAY E18: LOHJA - SALO, FINLAND.....	A2 -10
CASE STUDY D -	CENTRAL SEWAGE TREATMENT PLANT, TURKU, FINLAND.....	A2 -14
CASE STUDY E -	STRATHCLYDE CROSSRAIL, UNITED KINGDOM.....	A2 -18
CASE STUDY F -	REGINA TO STROMONA SECTION OF THE EGNATIA MOTORWAY, GREECE	A2 - 26
CASE STUDY G -	SECURING THE KIEL CANAL (SECTION RENDSBURG EAST), GERMANY	A2 -29
CASE STUDY H -	B452 REICHENSACHSEN BYPASS, GERMANY	A2 -35
CASE STUDY I -	KILLINGHOLME CCGT POWER STATION EXTENSION, UNITED KINGDOM.....	A2 -39
CASE STUDY J -	RETHIMNO CITY WASTE WATER TREATMENT WORKS, GREECE.....	A2 -45

ABBREVIATIONS

GLOSSARY

BIBLIOGRAPHY

USER GUIDE

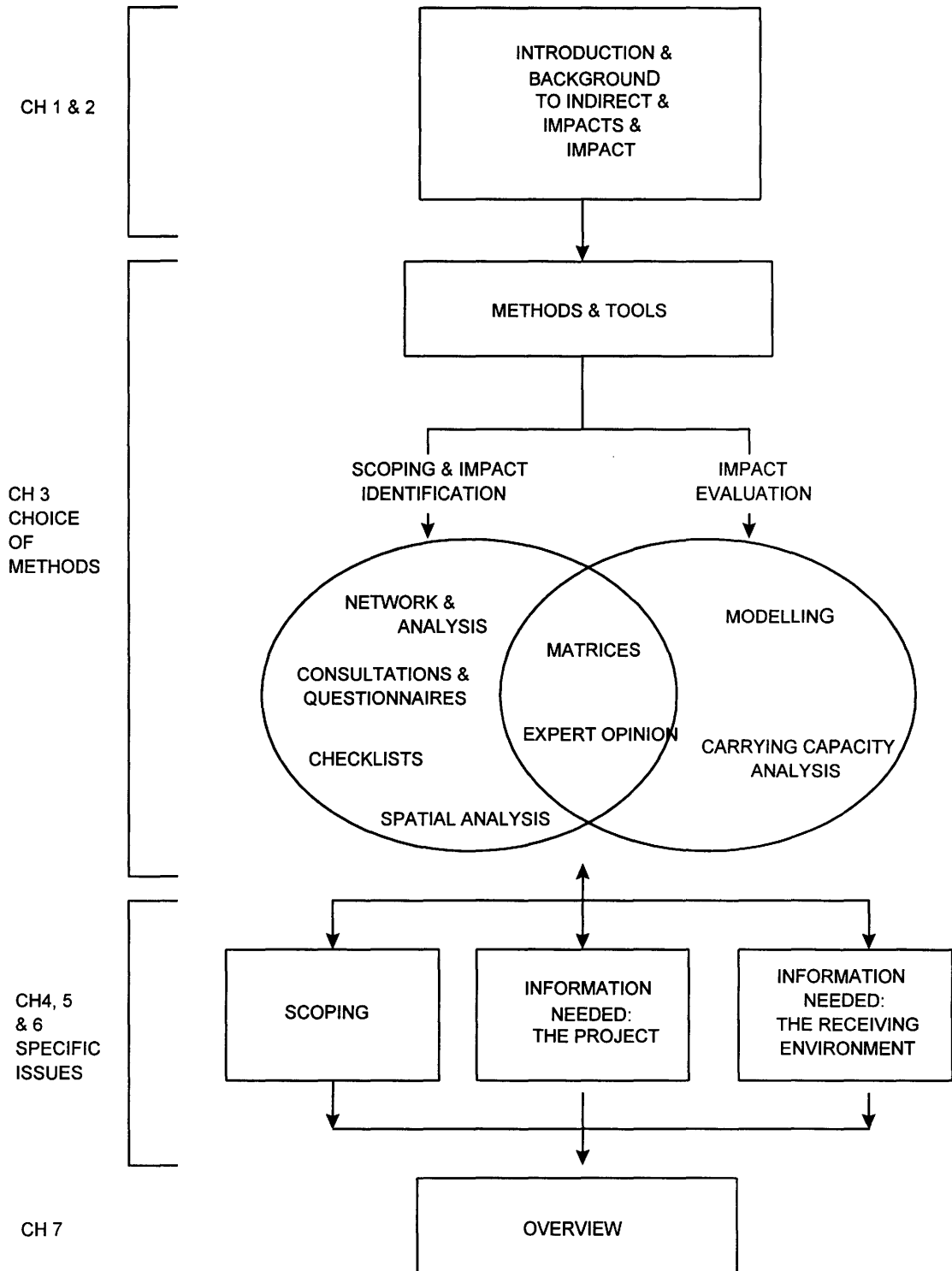

1. INTRODUCTION

1.1 *Objective of the Guidelines*

The Guidelines are intended for use by the Environmental Impact Assessment (EIA) practitioner and developer. The aim is to provide guidance on practical methods and approaches to assess indirect and cumulative effects of a project as well as impact interactions. It is hoped that the guidelines can be used and adapted to suit specific projects as required. The Guidelines are not intended to be formal or prescriptive but are designed to assist EIA practitioners in developing an approach which is appropriate to a project, and to consider these impacts as an integral part of the EIA process.

Although these Guidelines are primarily addressing EIA at the project level, the reader interested in the assessment of indirect and cumulative impacts as well as impact interactions at the most strategic level of plans, programmes or policies will find these Guidelines useful and to a large extent applicable.

The Guidelines have been designed to apply to a wide range of projects and to assist in the EIA process throughout the Member States. They explain the concept of indirect and cumulative effects as well as impact interactions and include information and advice to assist the EIA practitioner throughout the various stages of the established EIA process in identifying, assessing and reporting these impacts within the Environmental Statement. These guidelines also provide advice which is relevant to information required by EC Directive 96/61/EC concerning integrated pollution prevention and control (IPPC Directive) as discussed in Section 1.2.2 in detail.

The methodologies identified within these Guidelines are intended to be:

- adaptable to varying project types
- adaptable to varying environmental conditions
- adaptable to the various EIA systems operating in the Member States
- adaptable to Annex I and II projects
- cost effective and
- internationally acceptable.

1.2 Legislation

1.2.1 Environmental Impact Assessment

EC Directive 85/337/EEC on the assessment of the effects of certain public and private projects on the environment (henceforth referred to as the EIA Directive) and the amendment (11/97/EC) require that EIA is carried out for certain types of major projects which are judged likely to have significant environmental effects. The EIA Directive requires consideration of the direct impacts and of any indirect, secondary and cumulative effects of a project. It also requires consideration of the interactions between the environmental factors listed. The following tables are extracts from the Directive.

EC Directive (85/337/EEC) (as amended) - Article 3

The environmental impact assessment shall identify, describe and assess in an appropriate manner, in the light of each individual case and in accordance with the Articles 4 to 11, the direct and *indirect effects* of a project on the following factors:

- human beings, fauna and flora,
- soil, water, air, climate and the landscape,
- material assets and cultural heritage,
- *the inter-action between the factors mentioned in the first and second indents.*

EC Directive (85/337/EEC) (as amended) - Annex III Selection Criteria Referred to in Article 4 (3)

The characteristics of projects must be considered having regard in particular to:

- the size of the project,
- *the cumulation with other projects,*
- the use of natural resources
- the production of waste
- pollution and nuisances
- risk of accidents, having regard in particular to substances or technologies used.

EC Directive (85/337/EEC) (as amended) - Annex IV Information Referred To In Article 5 (1)

3. A description of the aspects of the environment likely to be significantly affected by the proposed project, including, in particular, population, fauna, flora, soil, water, air, climate factors, material assets, including the architectural and archaeological heritage, landscape and the *inter-relationship between the above factors*.
4. A description ⁽¹⁾ of the likely significant effects of the proposed project on the environment resulting from:
 - the existence of the project,
 - the use of natural resources
 - the emission of pollutants, the creation of nuisances and the elimination of waste, and the description by the developer of the forecasting methods used to assess the effects on the environment.

⁽¹⁾This description should cover the direct effects and any *indirect, secondary, cumulative, short, medium and long term, permanent and temporary, positive and negative effects of the project*.

This requirement has been included in legislation by some individual Member States. Where it has not been specifically translated into legislation in the other Member States these Guidelines are intended to encourage good practice in addressing such impacts.

1.2.2 Integrated Pollution Prevention and Control

EC Directive 96/61/EC concerning integrated pollution prevention and control (IPPC Directive) aims to establish an authorisation system requiring most medium-sized and large industrial installations to obtain an integrated operating permit that states limit values for emissions to air, water and land.

There is some overlap with the IPPC Directive and the EIA Directive. The IPPC Directive lays down measures designed to prevent or, where that is not practicable, to reduce emissions to air, water and land from activities listed in Annex 1. The objective of the IPPC Directive is to achieve a high level of protection of the environment taken as a whole, without prejudice to the EIA Directive and other relevant community provisions.

The following table is an extract from the Directive.

EC Directive 96/61/EC - Article 2

For the purposes of this Directive

- 'pollution' shall mean the direct or *indirect* introduction as a result of human activity, of substances, vibrations, heat or noise into the air, water or land which may be harmful to human health or the quality of the environment, result in damage to material property, or impair or interfere with amenities and other legitimate uses of the environment.
- 'emission' shall mean the direct or *indirect* releases of substances, vibrations, heat or noise from individual or diffuse sources in the installation into the air, water or land.

1.3 Background to the Research for Production of the Guidelines

The Guidelines are based on the results of a study commissioned by the European Commission, Directorate - General XI (Environment, Nuclear Safety and Civil Protection) which was undertaken by Hyder, an international Environmental Consultancy, in association with EURONET, a pan-European research and consultancy network. Additional input was provided by European partners based in Germany, Greece, Portugal and Finland and an Expert Panel made up of leading members of the European EIA Community.

Details of the methodology are provided in Appendix 1.

1.4 Structure of the Guidelines

The User Guide illustrates the layout of the Guidelines (see page xx).

These Guidelines have been produced to assist the EIA practitioner and the developer in identifying and assessing indirect and cumulative impacts, as well as impact interactions as part of the EIA process. The Guidelines are therefore structured to provide firstly an understanding of indirect and cumulative impacts, as well as impact interactions. Suggested tools and methods for identifying and assessing impacts are explained in Chapter 3 using examples. This is followed by guidance on how to integrate such assessments into the EIA process through scoping and data collection.

The Guidelines also include ten detailed case studies that review selected Environmental Statements from five Member States. These case studies illustrate the various approaches and methods which are being used to assess indirect and cumulative impacts, as well as impact interactions. These case studies are intended to illustrate the range of techniques currently being used.

However, it is important to recognise that for these projects, other approaches may also have been successful and therefore they are not necessarily suggested as 'best case' examples.

2. BACKGROUND TO INDIRECT AND CUMULATIVE IMPACTS AND IMPACT INTERACTIONS

2.1 *Indirect and Cumulative Impacts and Impact Interactions: A Definition*

A key problem identified in the research study was how to define indirect and cumulative impacts, and impact interactions. The definitions of these three types of impact overlap and consequently, most of the literature available on the subject classifies indirect impacts and impact interactions as components of cumulative impact. However, there are no agreed and accepted definitions. For the purposes of these Guidelines, which identify indirect and cumulative impacts, and impact interactions as discrete impact types, definitions have been developed which are illustrated by examples given below. More detailed examples are also given throughout the Guidelines. Although the definitions overlap, they are a useful starting point for the guidance.

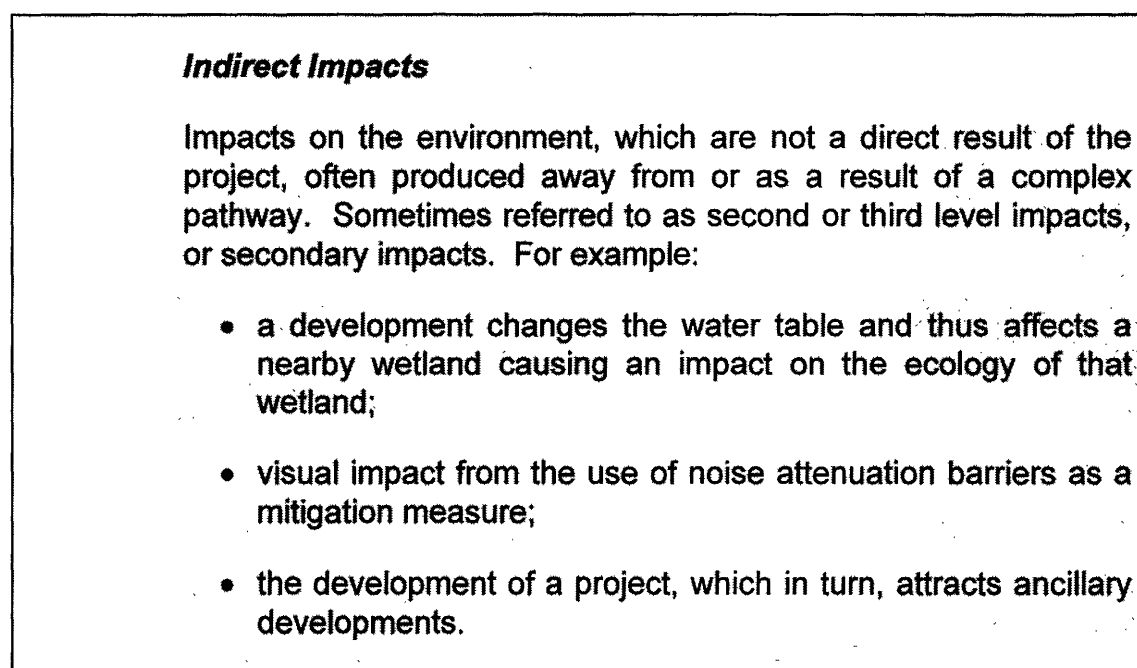

Figure 2.1 Flow Diagram Illustrating Indirect Impacts

Cumulative Impacts

Impacts that result from incremental changes caused by other past, present or reasonably foreseeable actions together with the project. For example:

- incremental noise from a number of separate developments;
- combined effect of individual impacts, e.g. noise, dust and visual, from one development on a particular receptor;
- Several developments with insignificant impacts individually but which together have a cumulative effect, e.g. development of a golf course may have an insignificant impact, but when considered with several nearby golf courses there could be a significant cumulative impact on local ecology and landscape.

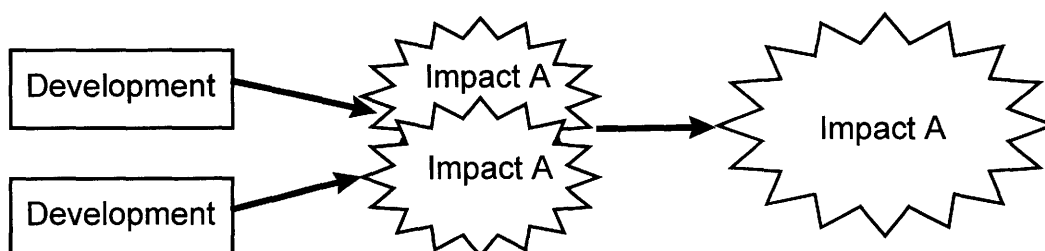

Figure 2.2 Flow Diagram Illustrating Cumulative Impacts

Impact Interactions

The reactions between impacts whether between the impacts of just one project or between the impacts of other projects in the area.

- a chemical plant producing two streams of waste that are individually acceptable but react in combination producing highly significant levels of pollution;
- emissions to air from one project reacting with emissions from an existing development.
- two major developments being constructed adjacent to one another and during overlapping time periods will have many interactive impacts, from land use issues to construction and operational noise.

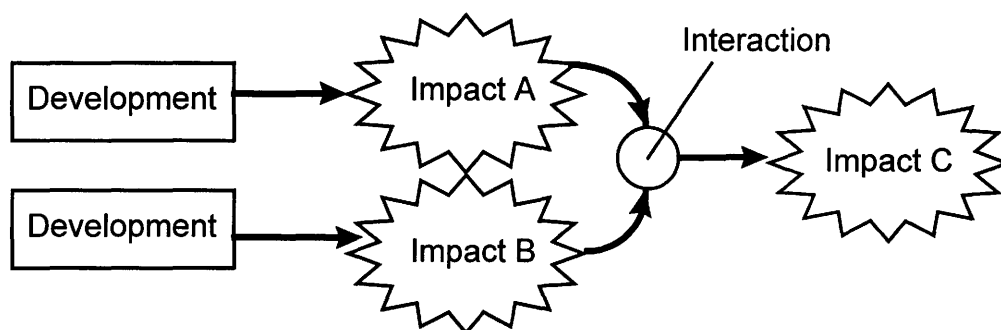

Figure 2.3 Flow Diagram Illustrating Impact Interactions

2.1.1 Cross Media Impacts

An impact which directly affects one environmental medium may also have an indirect impact on other media (sometimes referred to as cross media impacts). This indirect effect can sometimes be more significant than the direct effect. For example, in some cases, changes in noise or vibration levels may have a profound effect on nesting birds and badgers. Whilst the additional noise may not constitute a significant increase when using simple assessment methods, the indirect impacts on the ecology may be profound.

Visual intrusion may also have an indirect impact on the amenity value of sites of historical interest. Again, in the absence of the analysis of indirect impacts, visual intrusion may not be considered as significant. However, the indirect impacts may be considered as being substantial.

2.2 Why Assess Indirect and Cumulative Impacts and Impact Interactions?

2.2.1 Introduction

There are four main reasons why indirect and cumulative impacts and impact interactions should be included in an EIA. These are:

- It is required by legislation
- It contributes towards sustainable development
- It is good practice
- It aids the decision making process.

These are discussed in more detail below.

2.2.2 *Towards Sustainable Development*

The environmental effects which can result from indirect and cumulative impacts, and impact interactions can be significant. The objective of the assessment of indirect and cumulative impacts and impact interactions will be to identify and focus on the significant impacts. It will also ensure that these impacts are taken into consideration in the decision-making process.

The assessment of these effects assists in promoting sustainable development. That is development that meets the needs of the present without compromising the ability of future generations to meet their own needs (World Commission on Environment and Development 1987).

Environmental Assessment can be used on both a local and wider scale to promote the sustainable development of an area. Strategic Environmental Assessment (SEA) could be carried out by decision makers during the formulation of policies, plans and programmes. SEA can be utilised either in a sectoral context (e.g. forestry) or specific area-wide context (e.g. regional or national). Project environmental assessments, on the whole, do not fully consider the cumulative impacts caused by several projects or the sub-components of a project.

By introducing the Environmental Impact Assessment earlier into the decision-making process and encompassing all of the projects of a certain type or within a certain area it will be possible to ensure that alternatives are considered more fully. This will mean that the potential indirect and cumulative impacts and impact interactions could be identified and assessed much sooner. Such an approach is an important step towards sustainable development.

The problem with assessing such impacts at an earlier stage of the development process is that there will be a lack of detail of the nature, scale and location of future development. Often the baseline data will not be available for all of the area concerned. The impacts predicted to occur and therefore the assessment of them will be imprecise.

The assessment of indirect and cumulative impacts and impact interactions is not an alternative for strategic assessment. It is possible for both approaches to consider indirect and cumulative impacts, as well as impact interactions. Both types of assessment can consider, for example, the cumulative impacts of projects in the same area. The strategic assessment may be sectoral based, with the objective of assessing impacts from the same types of projects. In comparison the project assessment may assess the impacts of different actions in the same area.

2.2.3 *Good Practice*

The assessment of indirect and cumulative impacts and impact interaction should be recognised and promoted as good practice by policy-makers, EIA practitioners and decision-makers within the Member States. The practitioner

should therefore aim to assess indirect and cumulative impacts, and impact interactions at all stages of the project and to present the findings in the Environmental Statement. The Environmental Statement should be presented in a comprehensive, clear and objective manner, clearly understood by the developer, determining authority and the public. As with assessment of direct impacts, the assessment of indirect and cumulative impacts, and impact interaction should use systematic analysis based on practicable techniques and tools.

The direct impacts of a project can generally be predicted with certainty. However, the assessment of indirect and cumulative impacts and interactions may be met with uncertainties and may be based upon assumptions. In such situations the EIA practitioner will need to ensure that any assumptions made as part of the assessment are made clear.

In undertaking EIA of cumulative and indirect impacts and impact interactions it is important to realise the constraints, which are brought upon the assessment. The assessment should then be based on the best available data or technique at the time. The assessment will not and indeed cannot be, in many situations, a perfect assessment. However the potential for impacts will at least be considered, rather than omitted from the decision making-process all together. Such assessment is therefore of value to the project and the environment.

2.3 *Integrating Assessment of Indirect and Cumulative Impacts and Impact Interactions into the Project*

2.3.1 *Adopting an Integrated Approach*

The assessment of indirect and cumulative impacts and impact interactions should not be thought of as a separate stage to the EIA process. Indeed the assessment of such impacts should be an integral part of all stages of the process. The potential for these impacts to occur should be considered whilst undertaking the following:

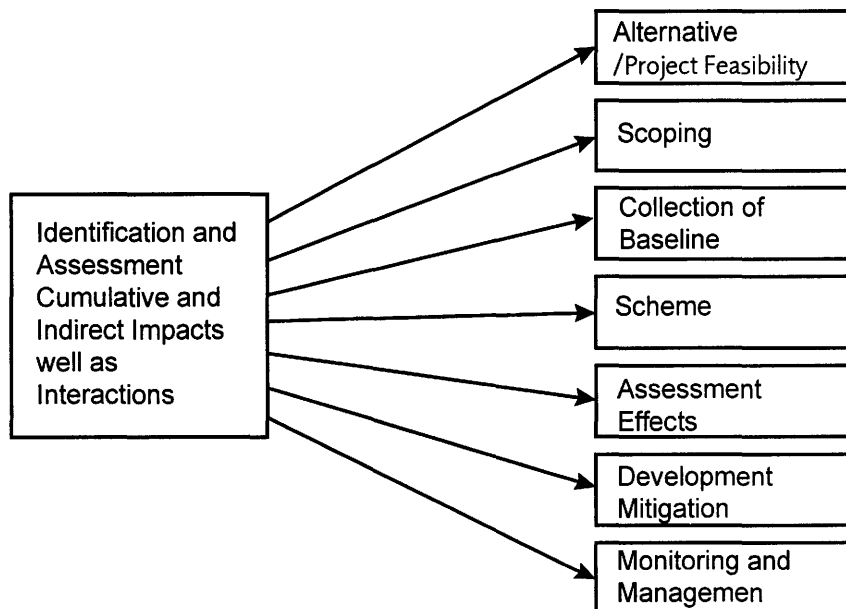

Figure 2.4 How the Assessment of Cumulative and Indirect Impacts as well as Impact Interactions can Apply to Various Stages of the EIA Process.

The assessment of indirect and cumulative impacts and impact interactions should be an iterative process, similar to that used in the assessment of direct impacts. In both cases the results of the assessment process should input into the design of the scheme and the development of mitigation measures.

Further details on scoping, baseline data and other points to consider during the assessment are given in more detail in Chapters 4, 5, 6 and 7.

2.3.2 *The Project Team*

EIA is a multi-functional activity. Establishing the right team for the project in the initial stages is important for EIA, and therefore also the assessment of indirect and cumulative impacts, and impact interactions.

Where environmental skills are available 'in house' it may be appropriate to supplement these with internal/external specialists to undertake assessments for certain topics or to co-ordinate and oversee the project (see Figure 2.5)

2.3.3 *The Project Co-ordinator*

The objective should ultimately be to assemble a multi-disciplinary project team, led by an individual with extensive experience in the practice of EIA. The team leader or project co-ordinator should preferably have some formal training in EIA, its application and practice. A project co-ordinator should take on a

number of responsibilities, such as client liaison, monitoring of the programme and general project management. In terms of the assessment of indirect and cumulative impacts and impact interactions the co-ordinating role would include:

- Managing the project team and ensuring that the specialists appointed work together as a team and are aware of requirement for the assessment of potential indirect and cumulative impacts, and impact interactions
- Consulting with non-statutory and statutory bodies to obtain their views on the potential for indirect and cumulative impacts as well as impact interactions, and to obtain information on other proposed developments within the area of the project.
- Identifying the potential for indirect and cumulative impacts as well as impact interactions by acting as the 'link' between the specialists engaged on the project and providing an overview and judgement on the level of assessment required and development of appropriate mitigation measures.

The key to the successful assessment of indirect and cumulative impacts and impact interactions is to co-ordinate the project team to ensure that the specialists are able to feed into the process to enable consideration of the potential for impacts between disciplines. A project leader or co-ordinator with an overall perspective will therefore play an important role within the team.

2.3.4 Project Co-ordination Group

The establishment of a group which meets regularly to discuss the environmental impacts of the project, their assessment and possible mitigation measures can provide a useful forum, particularly with respect to indirect and cumulative impacts and impact interactions. The group could include key specialists, the project co-ordinator, the developer and consultees.

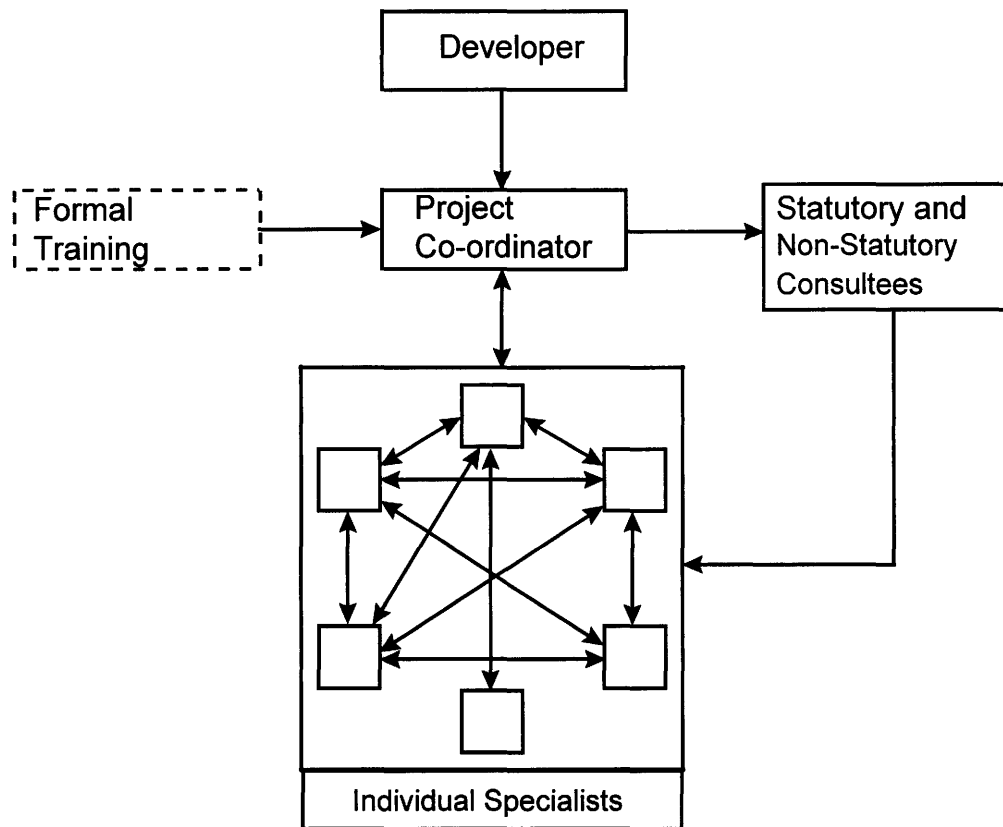

Figure 2.5 The Project Team.

2.4 Summary

The definitions of indirect and cumulative impacts and impact interactions often overlap. Including an assessment of the indirect and cumulative impacts and interactions in an Environmental Impact Assessment is good practice, contributes towards sustainable development and aids in the decision making process.

An integrated approach to indirect and cumulative impacts as well as impact interactions should be adopted through all the stages of the project. Establishing an appropriate project team is also of key importance.

3. METHODS AND TOOLS

3.1 Introduction

The purpose of these Guidelines is not to recommend a single method for assessing indirect and cumulative impacts and impact interactions, but to suggest various approaches which the practitioner can adapt and combine to suit the particular project which is the subject of the EIA.

These Guidelines provide information on eight methods and tools which were selected from case studies and literature research. Those selected were considered to be the most appropriate for use by practitioners. The methods and tools described in this Guidance generally fall into two groups. These are:

- **Scoping and Impact Identification** techniques - these *identify how and where* an indirect or cumulative impact or impact interaction would occur.
- **Evaluation** techniques - these *quantify and predict* the magnitude and significance of impacts based on their context and intensity.

During the EIA process it may be that a combination of techniques are used, or that certain approaches are adopted at different stages of the project. Examples of both categories are set out below:

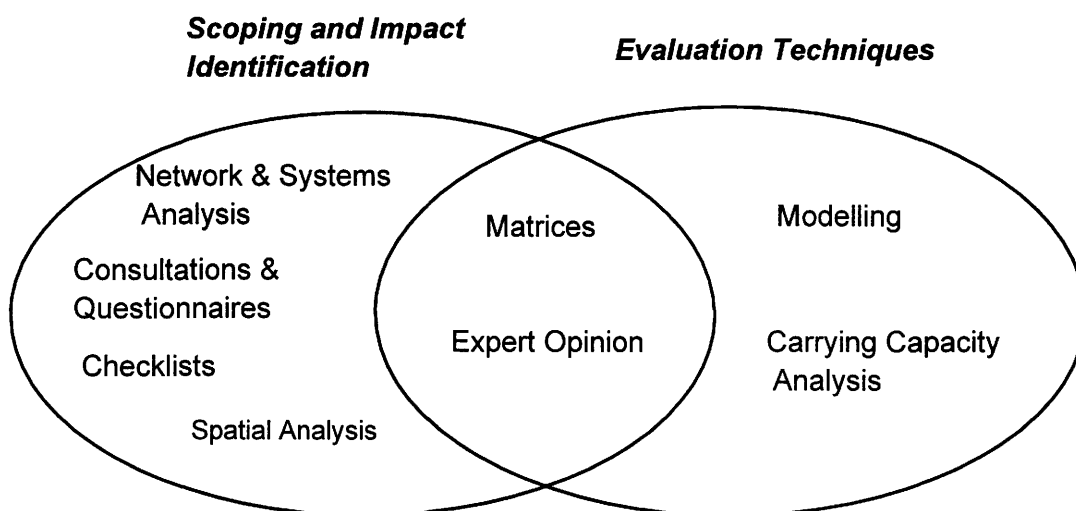

Figure 3.1: Methods and Tools for Assessment of Indirect and Cumulative Impacts as well as Impact Interactions.

This chapter provides a detailed description of each of the eight methods. For each method information is included on their advantages and disadvantages. Examples are given along with suggested steps to apply the method. Each

method is illustrated with case studies developed from the review of a number of Environmental Statements. An overview of the methods contained within this chapter is given in the following table.

The table suggests which methods are best suited to the assessment of cumulative impacts, indirect impacts or impact interactions.

Table 3.1 Summary of Methods for Assessing Indirect and Cumulative Impacts and Impact Interactions

Method	Description	Advantages	Disadvantages	Cumulative Impacts	Indirect Impacts	Impact Interactions	Identification	Evaluation
Expert Opinion	A means of both identifying and assessing indirect and cumulative impacts and impact interactions. Expert Panels can be formed to facilitate exchange of information of different aspects of the impacts of a project.	<ul style="list-style-type: none"> • Can consider such impacts as an integral part of the assessment. 	<ul style="list-style-type: none"> • Some specialists or experts may be remote from the main project team. 	✓	✓	✓	✓	✓
Consultations and Questionnaires	A means of gathering information about a wide range of actions, including those in the past, present and future which may influence the impacts of a project.	<ul style="list-style-type: none"> • Flexible • Considers potential impacts early on. • Can be focused to obtain specific information. 	<ul style="list-style-type: none"> • Prone to errors of subjectivity • Questionnaire can be time consuming, and risk of poor response. 	✓	✓	✓	✓	✗

Table 3.1 Summary of Methods for Assessing Indirect and Cumulative Impacts and Impact Interactions (cont.)

Method	Description	Advantages	Disadvantages	Cumulative Impacts	Indirect Impacts	Impact Interactions	Identification	Evaluation
Checklists	Provide a systematic way of ensuring that all likely events resulting from a project are considered. Information presented in a tabular format.	<ul style="list-style-type: none"> • Systematic method • Can develop 'standard' checklist for similar projects. 	<ul style="list-style-type: none"> • Can allow oversight of important effects • Nature of cause-and-effect relationships not specified. 	✓	✓	✗	✓	✗
Spatial Analysis	Uses Geographical Information Systems (GIS) and overlay maps to identify where the cumulative impacts of a number of different actions may occur, and impact interactions. Can also superimpose a project's effect on selected receptors or resources to establish areas where impacts would be most significant.	<ul style="list-style-type: none"> • GIS flexible & easy to up date. • Can consider multiple projects and past, present & future actions. • Allows clear visual presentation 	<ul style="list-style-type: none"> • GIS can be expensive & time consuming. • Difficult to quantify impacts. • Problems in updating overlays. 	✓	✗	✓	✓	✗

Table 3.1 Summary of Methods for Assessing Indirect and Cumulative Impacts and Impact Interactions (cont.)

Method	Description	Advantages	Disadvantages	Cumulative Impacts	Indirect Impacts	Impact Interactions	Identification	Evaluation
Network and Systems Analysis	Based on the concept that there are links and interaction pathways between individual elements of the environment, and that when one element is specifically affected this will also have an effect on those elements which interact with it.	<ul style="list-style-type: none"> • Mechanism of cause and effect made explicit. • Use of flow diagrams can assist with understanding of impacts. 	<ul style="list-style-type: none"> • No spatial or temporal scale. • Diagrams can become too complex. 	✓	✓	✓	✓	✗
Matrices	A more complex form of checklist. Can be used quantitatively and can evaluate impacts to some degree. Can be extended to consider the cumulative impacts of multiple actions on a resource.	<ul style="list-style-type: none"> • Provides a good visual summary of impacts. • Can be adapted to identify and evaluate to some degree indirect & cumulative impacts and impact interactions. • Matrices can be weighted/ impacts ranked to assist in evaluation. 	<ul style="list-style-type: none"> • Can be complex and cumbersome to use. 	✓	✓	✓	✓	✓

Table 3.1 Summary of Methods for Assessing Indirect and Cumulative Impacts and Impact Interactions (cont.)

Method	Description	Advantages	Disadvantages	Cumulative Impacts	Indirect Impacts	Impact Interactions	Identification	Evaluation
Carrying Capacity Analysis	Based on the recognition that thresholds exist in the environment. Projects can be assessed in relation to the carrying capacity or threshold determined, together with additional activities.	<ul style="list-style-type: none"> Addresses accumulation of impacts against thresholds. Considers trends in the environment. 	<ul style="list-style-type: none"> Limited to data available. Not always able to establish the threshold or carrying capacity for a particular resource or receptor. 	✓	✓	✗	✗	✓
Modelling	An analytical tool which enables the quantification of cause-and-effect relationships by simulating environmental conditions. This can range from air quality or noise modelling, to use of a model representing a complex natural system.	<ul style="list-style-type: none"> Quantifies cumulative effects Geographical and time-frame boundaries are usually explicit Addresses specific cause-and-effect relationships 	<ul style="list-style-type: none"> Often requires large investment of time and resources Can be difficult to adapt some models to a particular project. Depends on baseline data available. 	✓	✓	✓	✗	✓

3.2 *Selecting the 'Tools' and Methods for the Project*

There are a number of factors which will influence the approach adopted for the assessment of indirect and cumulative impacts and impact interactions for a particular project. The method should be practical and suitable for the project given the data, time and financial resources available. It should also be able to provide a meaningful conclusion from which it would be possible to develop, where necessary, mitigation measures and monitoring. Key points to consider when choosing the method(s) include:

- the nature of the impact(s),
- the availability and quality of data,
- the availability of resources (time, finance and staff).

The method chosen should not be complex, but should aim at presenting the results in a way that can be easily understood by the developer, decision-maker and the public.

3.3 *Expert Opinion*

3.3.1 *Introduction*

Cumulative Impacts	Indirect Impacts	Impact Interactions	Identification	Evaluation
✓	✓	✓	✓	✓

The technical input of project team members always forms an intrinsic part of the Environmental Assessment process. For this reason, the selection of appropriate project team members is an essential part of any project. These Guidelines describe a number of methods for identifying and assessing impacts. However, it is not possible to conduct any of these without the use of expert opinion. Expert opinion, although not a method as such, is effectively a 'tool' for the assessment of indirect and cumulative impacts as well as impact interaction.

Exchange of views and the effective liaison between members of the project team are of primary importance, especially with respect to indirect impacts, cumulative impacts and impact interactions. With these kind of impacts a number of different scientific disciplines are often required to analyse the network of interactions which occur.

It is the responsibility of the project co-ordinator to facilitate the exchange of ideas between team specialists, and ultimately to produce an Environmental Statement which integrates their expertise. There may be a tendency for experts to complete their own chapters of an Environmental Statement in isolation from other experts. This runs against the nature of many cumulative and indirect impacts, and impact interactions, because they often involve more than one scientific discipline or environmental receptor. Care should be taken to ensure that when producing the Environmental Statement, that effective communication is translated into the report.

3.3.2 *Advantages and Disadvantages*

The advantage of assembling a project team of experts led by a co-ordinator will be that indirect and cumulative impacts as well as impact interactions can be considered as an integral part of the Environmental Assessment process. Regular team meetings with interaction between specialists will also facilitate identification of such impacts.

The disadvantage of this approach to project organisation may be that specialist and experts forming part of the team are remote from the core team. However, this disadvantage can to some extent be overcome by good project co-ordination.

3.3.3 *Application of the Method*

Expert opinion should be an integral part of the Environmental Assessment process. It is therefore important to take the following into consideration to ensure that experts are appointed to the team and input into identifying and assessing indirect and cumulative impacts as well as impact interactions.

Using expert opinion alone may be sufficient to identify and assess indirect and cumulative impacts as well as impact interactions for simple projects. However for more complex projects expert opinion may be used to apply other methods or 'tools' also included in these Guidelines.

Expert opinion is a method that can be applied for all project types and all environmental conditions. It is a tool which can be applied throughout a project. The number of experts, and the areas of experience they cover, can be adapted to suit each particular project as required.

The key activities will therefore be to:

- appoint an experienced project co-ordinator;
- identify requirements for specialists and appoint experts where necessary;

- ensure co-ordination between the members of the project team;
- involve experts in the project team in using other 'tools' to identify and assess indirect and cumulative impacts as well as impact interaction.

3.3.4 Case Studies

The importance of a project co-ordinator and appointment of specialists is illustrated in the following case study of the Nestos River Project (See Appendix 2A for full details).

Case Study: Nestos River Project, West Thrace, Greece

Expert opinion was used during the Environmental Impact Assessment of the Nestos River Project.

The identification and assessment of indirect and cumulative impacts as well as impact interactions was based on the experience of the project co-ordinator and the specialists appointed to the project team. This approach was facilitated by close interaction between members of the project team. This allowed exchange of ideas and enabled the project co-ordinator an overall perspective of the indirect and cumulative impacts and their significance to the project.

3.4 Consultations and Questionnaires

3.4.1 Introduction

Cumulative Impacts	Indirect Impacts	Impact Interactions	Identification	Evaluation
✓	✓	✓	✓	✗

Consultations and questionnaires are information gathering techniques which can assist in defining the scope of the assessment and in identifying where and how indirect and cumulative impacts and impact interactions may occur. They are therefore often used at the Scoping stage of a project.

Consultation is a key element in the Environmental Assessment process and can be carried out through meetings or correspondence. It is a way of obtaining data for use in the assessment. It is also useful in determining the views and concerns of those consulted regarding the project and therefore in identifying the key issues. Consultees may typically be:

- the relevant statutory and non-statutory authorities,
- experts in a particular subject matter associated with the project and its potential impacts,
- local businesses and the local community who may be affected by the project.

Questionnaires are another method for obtaining information, particularly from businesses, local interest groups and residents who may be potentially affected by a proposed project. They can either form the basis of an interview or be used as postal questionnaires.

Both consultations and questionnaires assist in the collection of baseline data and enable a greater understanding of the potential project impacts, resources affected and possible mitigation measures.

Consultation, which will be carried out anyway as part of the assessment, is a tool that can be used to obtain information wherever possible on:

- other actions in the past, present and future which may impact on the project,
- resources and opinions and concerns on the potential impacts of the project.

Questionnaires can be used to complement the consultations and obtain specific information not always readily available.

The number of consultees, frequency of meetings or discussions and the extent and detail of information requested in questionnaires will need to be determined based on each individual project. However, both methods or 'tools' can be useful in identifying indirect and cumulative impacts, as well as impact interactions.

3.4.2 *Advantages and Disadvantages*

Using the consultation process to gather information on potential indirect and cumulative impacts and impact interactions enables these potential impacts to be considered early on in the assessment process. There can be problems, however, in that the appropriate data is not always available, some consultations can be time consuming which may add to the project costs. There may also be an issue of confidentiality if obtaining data on other developments.

Questionnaires can be time consuming and labour intensive if there are large numbers of people or businesses to contact. It may, in some cases, be more appropriate to approach the relevant community groups who would act as a channel for the information. There is also the risk of poor response to the questionnaire, therefore not providing sufficient information that can be readily used and relied upon in the assessment.

3.4.3 Application of the Method

The practitioner should consider carefully who would be able to provide information which may be useful to the assessment of indirect and cumulative impacts and impact interactions. When carrying out the consultations the practitioner should specifically request information such as:

- what are the sensitive resources/environmental elements in the study area?
- what is the threshold beyond which there will be significant environmental impacts for any particular resource?
- what actions are there in the past, present and future which may influence the impacts of the project?

In order to rationalise the data collection it will be useful to specify the geographical boundary and time frame. It may be necessary however, to re-consult if the design of the project has significantly changed or the study area is no longer appropriate. If the assessment is taking place over a long period of time there may be a change in baseline conditions or other actions which may influence the impacts of the project so the consultation process would need to be repeated.

The data that is collected, together with any opinions on the potential impacts, can be analysed to identify where indirect or cumulative impacts or impact interactions may occur. Other methods should then be used to assess such impacts.

Questionnaires are particularly useful to obtain socio-economic information. The questionnaire should be designed to ensure that the data that is gathered will be suitable for use in the assessment.

Consultations and questionnaires are tools which can be used to help identify where impacts would occur for a wide range of project types through data collection. They can be used for all project types and environmental conditions. They are particularly useful at the scoping stage of a project. Both tools can be adapted to suit a particular project in terms of the number of consultees and details of any questionnaire. Questionnaires are particularly useful in identifying impacts of a socio-economic nature. They are also appropriate for large scale projects where there are a large number of interested bodies or members of the public who are consulted.

3.4.4 Case Studies

Extracts from the following case studies illustrate how this method has been used in practice. The case studies are given in full in Appendix 2 B, C and D.

Case Study 1: Cardiff Waste Water Treatment Works (WWTW), UK

Cumulative and indirect impacts were identified through extensive and ongoing consultation with statutory and non-statutory organisations throughout the assessment. The consultation exercise was used to collect baseline environmental data and the opinions and concerns of those consulted. On a number of occasions joint meetings were held with various statutory bodies in order to identify key issues.

Several potential significant impacts of a cumulative nature were identified as a result of the project in combination with other future developments in the area, in particular a new road which was planned adjacent to the WWTW and an ecologically sensitive area (the Severn Estuary Site of Special Scientific Interest (SSSI), Special Protection Area (SPA), Special Area of Conservation (SAC) and Ramsar site).

Consultations with the planning authority and nature conservation authority identified the need to assess the impact from both the WWTW and the road scheme on the ecology (birds could experience disturbance from the cumulative impacts of noise and the physical presence of the projects), landscape and traffic levels. The cumulative assessment considered the impacts from a number of scenarios which were if:

- the WWTW was built before the road
- both projects were built at the same time
- the WWTW was built after the road

It was through the continued liaison with consultees that the potential cumulative impacts were identified and then assessed.

Case Study 2: E18 Highway, Lohja to Salo, Finland

The project concerned the proposed construction of a new road between the settlements of Lohja and Salo. The potential for indirect impacts such as the severance and change in movement patterns caused as a result of the road was identified. Questionnaires were distributed to residents, owners of summer cottages in the area, and local businesses, for their opinions on the road link and impact that it may have on them.

The information gathered from the questionnaire and meetings provided the basis for the assessment of the indirect impacts on the communities. For example, the indirect impacts on bus companies currently operating in the area was considered. The assessment used data gathered from the questionnaires on existing routes, travel times and customer base and considered this against the possible new route and diversions that the buses would have to make. From this it was possible to ascertain how the passengers, and therefore the businesses would be affected.

Case Study 3: Central Sewage Treatment Plant, Turku, Finland

Questionnaires were used in this project to gather baseline information on the environmental 'values' of the residents in the area likely to be affected by the sewage treatment plant and their concerns regarding the project.

The information gathered focused on what was important to residents, for example good air quality, quiet roads and uncluttered views. This was taken together with the assessment of the direct impacts of the project and where more than one such impact affected the residential area, for example odour from the works and the visual intrusion of the stack, the overall cumulative impact on humans was considered.

3.5 Checklists

3.5.1 Introduction

Cumulative Impacts	Indirect Impacts	Impact Interactions	Identification	Evaluation
✓	✓	✗	✓	✗

Checklists and matrices are similar in that they both use a tabular format for presenting information. However, the checklist is more simplistic and provides a way of systematically ensuring that all likely impacts are considered. For ease of definition these Guidelines are based on the assumption that checklists are used for identifying impacts and therefore they do not attempt to weight or

attach significance to impacts as matrices can do. They are best described as a tool that acts as a 'prompt' for the practitioner.

There are a number of types of checklist which are often used to identify direct impacts. These can also be applied to identify cumulative impacts in particular. Successful use of this tool however, relies on the experience of the practitioner in identifying the activities and key sensitive resources.

Checklists are often used as a tool for identifying impacts at the Scoping stage of a project, providing a structured approach for the practitioner to follow. However, use of a checklist does not mean that other activities, such as consultations, are not required during Scoping.

The exact form of the checklist can vary according to the type and detail of information required. For example they can be developed to:

- enable comparison of alternative options
- take into consideration past, present and future actions
- consider impacts on environmental parameters or components (e.g. air quality, ecology, landscape);
- consider impacts on sensitive receptors or geographical areas (e.g. a residential area).

All types of checklist use a tabular format to present information which considers the potential impact of activities of a project on the different components of the environment.

3.5.2 *Simple Impact Identification Checklist*

In its simplest form, a checklist can identify which resource/environmental component would be affected by a particular activity through the use of, for example, a tick to confirm this. Where there is no impact this is shown by leaving the box blank. On this resource-based approach, two or more effects indicate a cumulative impact. An example of a simple checklist is shown below. A more detailed example is illustrated in the Case Study for the Sewage Treatment Plant at Turku in Finland (Appendix 2D).

	Potential Impact from Construction Activities				
Resource	Site Clearance	Earth Moving	Lay foundations	Import materials	Cumulative impacts
Air Quality	✓	✓			✓
Water Quality		✓			
Landscape	✓	✓		✓	✓
Ecology	✓				
Noise	✓	✓	✓	✓	✓
Archaeology	✓				
Traffic	✓	✓	✓	✓	✓

✓ = impact

Table 3.2 Example of a Simple Checklist.

3.5.3 Descriptive Checklists

Descriptive information can also be included in checklists which are specific to impacts on certain components. This provides more information on the nature and magnitude of the impacts rather than just identifying whether they would occur or not. The information contained within each box can be quantitative or qualitative. The identification of the incidence of cumulative impacts is again essentially reliant upon expert opinion.

The following table is an example of a descriptive checklist, taking into consideration past, present and future actions.

Resource	Past Activities	Present Activities	Project Impact	Future Activities	Cumulative Impact
Groundwater	Contamination from industrial use	Contamination from surface water percolation	Excavation of site would result in mobilisation of contaminants	Contamination from surface water percolation	Contamination exceeds standards
Air quality	No significant impact from emissions	Emissions from existing power station within standards	Additional emissions	Emissions from existing power station within standards	Combined emissions of two power stations result in significant impact

Table 3.3 Example of a Descriptive Checklist for a Power Station Development.

3.5.4 Geographical or Receptor Based Checklist

Checklists are most commonly used to identify impacts on environmental components. The tool can also be adapted to consider how various impacts of a project, or a number of projects, can combine to affect a geographical area or receptor. An example of this approach is given in the Strathclyde Crossrail project case study where the cumulative impacts on a particular area were considered (Appendix 2E).

3.5.5 *Advantages and Disadvantages*

Checklists provide a simple way of identifying where impacts are likely to occur as a result of certain activities associated with a project and any other developments where appropriate. The main advantage of a checklist approach is that it is structured and will therefore help to avoid overlooking potential impacts.

This approach can allow relatively easy comparison of alternatives or options for a project at the early stages. It is also possible to develop standard checklists for certain project types. These can then be modified according to individual project and site characteristics. Checklists can be adapted to take into consideration past, present and future activities.

The checklist approach is probably best suited to instances where Environmental Statements are written for the same kinds of project on a frequent basis. For example, a practitioner working predominantly within the road construction industry could use a checklist developed for exactly this purpose.

Checklists do however, have the potential to either be incomplete in their coverage and to miss important effects, or to cover too wide a range of effects, which can prove difficult to manage. Care also needs to be taken to avoid double counting of impacts.

Another limitation of checklists is that they may not indicate the likelihood of an impact or prioritise impacts. This problem can be avoided by editing the complete list of identified impacts down to a manageable size for interpretation and presentation. Checklists are also prone to pigeon-holing impacts into certain categories, whereas in reality, an impact may be part of a complex system.

3.5.6 *Application of Method*

Developing a checklist will be dependant upon a number of activities. The steps to be followed are:

- consider and list the activities associated with project;
- identify and list the sensitive resources;
- identify and list other past, present and future actions which may also affect resources;
- identify where impacts arising from activities may occur and show on checklist. This may be carried out by completing boxes with a qualitative assessment (descriptive checklist) or by using a symbol to indicate an impact (simple checklist);

- identify cumulative impacts by identifying if a number of different activities (including those from other developments) impact on a single resource or receptors.

Checklists can be used for all types of projects and environmental conditions. They are particularly useful at the scoping stage and as a tool to compare options. They can also be adapted to assess impacts on a particular environmental parameter, or alternatively on a geographical area or receptor. They can also be adapted to address both physical and socio-economic impacts.

3.5.7 Case Studies

Extracts from the following case studies illustrate how this method has been used in practice. The case studies are given in full in Appendix 2D and E.

Case Study 1: Turku Central Sewage Treatment Plant, Finland

During the scoping exercise a simple checklist was used to identify impacts. The following checklist shows how a number of activities will impact on a single resource. For example, ground preparation work, treatment of waste water, treatment of sludge, traffic and disturbances in operation will all impact on air and climate, resulting in a cumulative impact.

The table also demonstrates that certain impacts on environmental parameters can result in a cumulative impact, and this is identified in the final column of the table which shows impacts on the overall amenity of human beings. For example, the treatment of waste water and also treatment of sludge will result in cumulative impacts which will affect human beings in terms of quality of life (recreation and in terms of health, smells, etc.).

Table 3.4 Checklist Used for Identifying Impacts of the Turku Central Sewage Treatment Works

	Impacts on environment						Impacts on built environment						Impacts on human beings				
	Soils and Geology	Surface and groundwater	Air and climate	Flora and fauna	Urban structure and planned land use	Buildings and structures	Landscape and townscape	Cultural heritage	Health, smells, noise and vibration	Quality of life and recreation	Economic life and employment	Use of natural resources					
Construction																	
ground preparation work	√	√	√			√		√	√	√		√					
surface structures					√	√	√	√	√	√							
Operation																	
treatment of waste water		√	√	√	√			√	√								
intake and removal of air								√	√								
treatment of sludge			√		√			√	√								
Transport																	
traffic			√		√			√	√								
Exceptional circumstances																	
disturbances in operation		√	√	√				√	√			√					

√ Indicates which issues the project is assumed to have an impact on. The lack of the symbol indicates that the impact will not occur or that it is likely to be insignificant.

Case Study 2 Strathclyde Crossrail, Glasgow, UK

The Environmental Statement included a separate Chapter which adopted a linear approach to the assessment by dividing the route of the Crossrail into a number of sections, determined by the sensitivity of the receptors within these areas. The assessment then considered the combined impacts on these sensitive receptors.

The conclusions of the assessment were used to produce a preliminary table of results in which all receptors for all subject areas were listed, together with the assessment made. This process revealed that, while some localities or features were reported in several subject areas, some features were reported only once. To provide a manageable assessment of cumulative effects, the cumulative assessment process concentrated on the key geographical areas and receptors. This acknowledges that a variety of receptor types located in the same area may be considered together.

The Chapter did however note that for some aspects of the appraisal, the significance of the effects has been reported at an area-wide level and could not be attributed to a specific site.

The Environmental Statement included a summary of the key environmental effects in tabular form, which can be used for reporting purposes as explained in section 7.7.1. An extract from the table of cumulative impacts (Appendix J of the Environmental Statement) is reproduced for information.

Table 3.5. Table of Cumulative Effects: High Street to Glasgow Cross (from Strathclyde Crossrail Environmental Statement)

	Traffic, Movement & Access	Noise & Vibration	Air Quality & Electromagnetic Radiation	Water Resources & Contaminated Land	Nature Conservation	Townscape & Visual	Cultural Heritage	Socio-economic Issues	Construction Activities
General Corridor Wide Effects	General improvement to accessibility on east side of city centre.	Not significant. The ambient noise level is controlled by road traffic noise	Changes in air quality likely to be not significant to minor beneficial	No significant effects are envisaged	No significant effects are envisaged	Overall moderate adverse effect on townscape and visual amenity	Moderate adverse effect on setting of Conservation Area	Improvement in pedestrian accessibility to socio-economic resources on east side of city. Moderate to minor beneficial	
High Street/ College Goods Yard	Kings Car Park removed. Moderate adverse. Loss of 20 spaces from SRC car park. Minor adverse.						Encroachment on area of high archaeological interest. Major to moderate adverse effect.	Loss of Kings street Car Park. Moderate adverse. Loss of land from Scottish Studio Engravers. Minor adverse.	Temporary loss of Hunter Street car park. Access arrangements to Scottish Studio Engravers adversely affected.
High Street Station	Walking distance increased by 80m. Minor adverse. Mobility impaired persons access from High Street Station to platforms.							Loss of eight archway units on Molendinar Street. Minor adverse.	

Table 3.5 Table of Cumulative Effects : High Street to Glasgow Cross (Cont.)

	Traffic, Movement & Access	Noise & Vibration	Air Quality & Electromagnetic Radiation	Water Resources & Contaminated Land	Nature Conservation	Townscape & Visual	Cultural Heritage	Socio-economic Issues	Construction Activities
Bell Street	Severed to road traffic. Traffic re-routed on local network. Potential improvements for access to remaining properties. Perceptual changes to pedestrian route along Bell St. Minor adverse effect.					Demolition of Stables Block - moderate adverse effect on the local townscape. Moderate to minor adverse effect on properties overlooking the alignment.	Listed building demolished - major adverse effect. Setting of Conservation Area and remaining buildings affected - moderate adverse effect.	Loss of 29 residential units on Bell St. - minor adverse effect. Minor adverse effect on businesses in Bell St./Hunter St./Gallowgate from severance of Bell St.	Access to Bell St. Limited during demolition of Stables Block. Utilities affected with construction of new railway embankment. Increased HGV movements.

3.6 *Spatial Analysis: Overlay Mapping And Geographical Information Systems (GIS)*

3.6.1 *Introduction*

Cumulative Impacts	Indirect Impacts	Impact Interactions	Identification	Evaluation
✓	✗	✓	✓	✗

Overlay mapping and GIS are methods for identifying the spatial distribution of impacts, and can assist in identifying where cumulative impacts and impact interactions may occur as a result of a project. Both methods involve the preparation of maps or layers of information which are then superimposed on one another. This can be to provide a composite picture of the baseline environment, identifying the sensitive areas or resources; to show the influences of past, present and future activities on a project or receiving environment; and to identify where several impacts can cumulatively affect one particular receptor.

Manual overlay mapping uses a series of transparent maps with different information shown on each which are then superimposed. The areas where there are overlaps of information can be determined, these therefore being the areas where there are potential significant cumulative impacts or where impact interactions may take place. GIS is a computer-based system into which data is input and layers of information created representing different resources or impact distributions. These are overlain within the system and again the areas of potential cumulative impacts or interactions identified.

The methods can be used to produce maps of the cumulative impact on a specific receptor from one project, or can map the impacts from a number of projects on receptors. They can also be used to show previous impacts, and to predict future impacts.

3.6.2 *Advantages and Disadvantages*

Both manual overlay mapping and GIS provide an invaluable visual aid for the practitioner, and greatly assist in identifying where impacts, which may be cumulative or interactive in nature, may occur. Manually preparing maps or overlays is generally relatively inexpensive and quick. However there are

some restrictions with what can be represented manually, and there is the increased possibility of inaccuracies in the mapping.

Using GIS allows the rapid construction of multi-layered electronic maps and can be regarded as the high-tech equivalent of overlay mapping. As a system for spatial analysis, it allows a wide range of environmental components to be input into the same computer model which can then be selected according to which are required. GIS can also be useful in dealing with large areas.

This approach has several advantages over traditional overlay mapping. Maps are static and therefore difficult and expensive to keep up to date. They are also inflexible. GIS has much greater flexibility, because a paper map can be produced from the electronic base with exactly the right information to meet the need of the user. An additional benefit with regards to cumulative impacts is that once a base GIS has been prepared, further developments can be added as and when necessary. Impacts can therefore be combined in an additive way, or certain process equations used to account for impact interactions. Because GIS data is stored in digital form, analysis and modelling also become possible.

GIS generally provides a more sophisticated analysis and is able to handle large amounts of data easily. The data however, has to be in the correct format for use and interpretation by the GIS. On the whole, unless there is a system already available for use with a project it can be expensive to buy, set up and run a GIS package. There is also a need for skilled staff to operate the system.

With both tools it is possible to assign a weighting. With the overlay technique, shading will identify areas with the greatest potential impact. Similarly, numerical weighting can be used in GIS for each map area. Both techniques will however depend on the use of expert opinion or statistical information (if available).

3.6.3 *Application of the Method*

The baseline environmental data for the assessment should be collected, together with information on other actions in the area which may affect the impacts of the project. For the identification of cumulative impacts arising from one project on a particular receptor the steps set out here should be followed:

- map the extent of the receptor, for example residential areas, within the study area chosen;
- establish the spatial distribution of the direct impacts and map these on individual maps;

- overlay the impact maps onto the receptor map. Where the extent of the different impacts can be seen to overlap on a residential area those living there will experience a cumulative impact from the project.

When considering the cumulative impacts from different projects the baseline conditions should be mapped as before. Information on other projects, such as their location and distribution of impacts if known, which may affect the resources should also be mapped. The maps showing the areas of influence of the other actions should be overlain on the map of the project and particular resource, for example a river. From this the areas where the project, together with other developments will potentially cumulatively affect the resource can be established. The diagram below illustrates how this works:

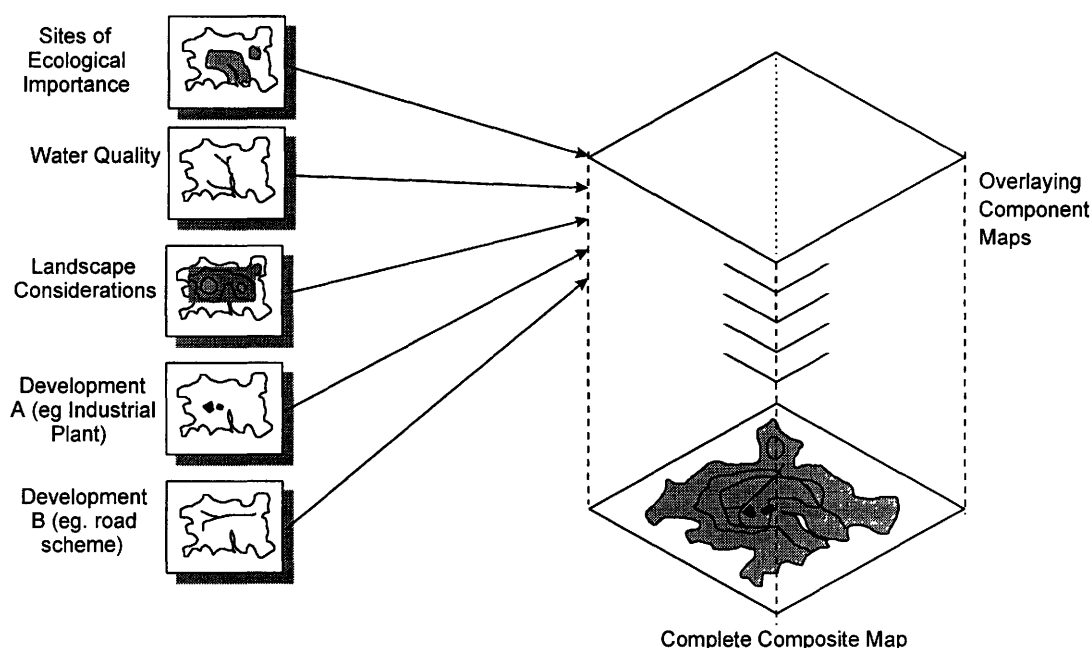

Figure 3.2 The Compilation of an Overlay Map from Various Component Maps.

Spatial analysis can be applied to a range of projects and environmental conditions. GIS is particularly suited to large scale or complex projects and for projects where analysis or modelling is required. However, GIS can be expensive and it is often not appropriate for small scale projects. For such smaller scale simple projects overlay techniques are more suitable.

Both tools are best suited for identifying physical impacts in terms of geographical location.

3.6.4 Case Studies

An extract from the following case study illustrates how this method has been used in practice. The case study is given in full in Appendix 2F.

Case Study 1: Regina to Stromona Section of the Egnatia Motorway between Greece and Turkey

Baseline data collected during the preparation of the Environmental Statement for this major highway development was used to develop a GIS system. Climatic and topographical data, in addition to information regarding important local ecological and archaeological sites, was collected for a 30km wide corridor along the route of the road.

Many archaeological sites were identified close to the route chosen for the road which would not be directly affected by construction. These sites however, had the potential to be affected by acid deposition as a result of sulphur dioxide (SO₂) and nitrogen oxides (NO_x) produced by vehicles using the road and carried in the form of 'acid rain'. The highest concentrations of these pollutants were not necessarily confined to the road where they were emitted by the traffic.

The GIS was used to map the dispersion of acid rain based on climatic and topological data. The dispersion data was superimposed on the map of the archaeological resources. This identified the extent of the impact of where sites may be at risk from decay as a result of the acid rain patterns. A number of changes were made to the final choice of routes on the basis of the GIS findings.

3.7 Network and Systems Analysis

3.7.1 Introduction

Cumulative Impacts	Indirect Impacts	Impact Interactions	Identification	Evaluation
✓	✓	✓	✓	✗

When identifying where possible indirect and cumulative impacts and impact interactions may occur as a result of a project the cause and effect relationship should be established. The network analysis assessment method is based on the concept that there are links and interaction pathways between individual elements of the environment, and that where one element is specifically affected this will also have an effect on those elements which interact with it.

Network and systems analysis identifies the pathway of an impact using a series of chains (networks) or webs (system diagrams) between a proposed

action and the receptor of an impact. Analysing the response of a receptor to a particular action and identifying where there are knock-on effects on other receptors or environmental elements enables consideration of indirect impacts and interactions between both the actions of a project and the impacts themselves. Cumulative impacts can also be identified in network and systems diagrams where different actions or developments can affect the same environmental element or receptor.

Feedback can be incorporated into such a model, which is often then known as loop or network analysis. The diagram is constructed based around a core or composite network, with a series of loop diagrams providing information about certain feedback mechanisms which are operating.

This approach is sometimes used at the Scoping stage of a project. It can also be used to compare alternative options.

3.7.2 Impact Chains

The basic component of network and systems analysis is the impact chain. Impact chains illustrate the process of cause and effect including the knock-on effects on other environmental receptors. They can be linked together to construct more complex diagrams, which include a wider range of indirect impacts and more impact interactions. The diagram below gives an example of how a simple impact chain can be constructed.

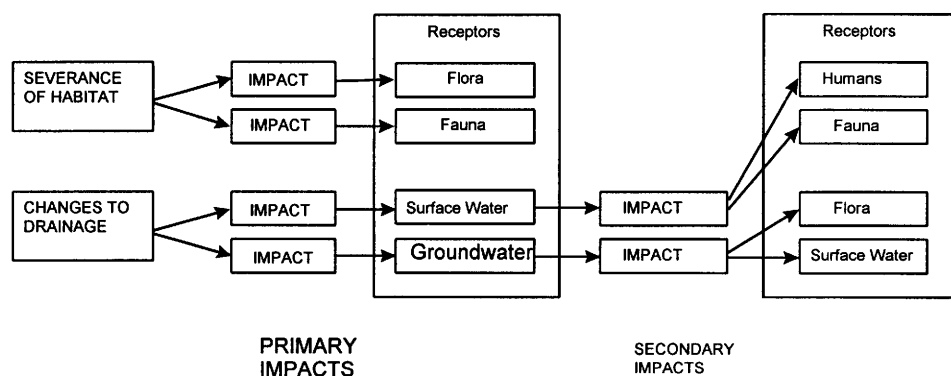

Figure 3.3: An Example of how Impact Chains can be Used to Illustrate Indirect Impacts and Impact Interactions.

Several indirect impacts can develop as a result of a direct impact. The chain therefore becomes more complex. The method allows the identification of follow-on impacts on other elements, resulting from impact interactions between the individual system elements.

If appropriate and if sufficient data is available, it is possible to include quantitative measurements in the network diagram using a common unit (usually energy). This technique constitutes a simple form of modelling and allows the evaluation of effects and their interactions.

3.7.3 *Advantages and Disadvantages*

The main advantage of using network and systems analysis is that it makes explicit the multiple and often complicated nature of impacts resulting from a project. This is particularly true of indirect impacts and impact interactions which would not always be apparent using simpler forms of analysis.

Network diagrams clearly illustrate the interaction pathways between the elements of the environment. In particular, the mechanisms of cause and effect are made apparent. This allows the practitioner to select which processes should be looked at in further detail. Although network analysis may not be quantitative, it will still provide a good basis for choosing which processes should be quantified or modelled in further detail, should this be possible.

Because network analysis uses such a holistic approach to impact assessment, it has the potential to require a slightly higher time or cost input. However, this investment can be worthwhile considering the additional impacts which the method has the capacity to identify.

3.7.4 *Application of the Method*

Developing a network or system analysis will be dependant upon a number of activities. The steps that could be followed are:

- consider and list the activities associated with project;
- identify and list the sensitive resources;
- select either a network approach or a systems approach depending on nature of the assessment. A simple network may be appropriate for the Scoping stage or alternative site assessment. For a more detailed assessment the sensitivity of the receptors and the nature of the activities associated with the project will be important factors. A complex systems analysis is unlikely to be appropriate for a simple project. Conversely a project in a particularly sensitive area may benefit from the use of a more complex analysis technique;
- identify pathways from direct impacts on resources;

- identify 'knock on' effects on other receptors or environmental elements;
- identify if different actions or different developments can impact on the same resource;
- if appropriate consider a loop to show feedback;
- if appropriate use quantitative techniques as a simple form of modelling to evaluate the effects.

Networks and systems analysis can be used for a variety of project types and environmental conditions. Simple networks are particularly suitable for scoping and to compare options. A more complex analysis will be better suited to a large scale project or a project in a particularly sensitive location. Both tools can be used to consider physical as well as socio-economic aspects.

Although networks and systems analysis can apply to all projects, for large scale projects which affect a number of ecosystem types (for example linear projects such as major highway or railway schemes) the separate analysis required for each ecosystem could result in a complex assessment.

3.7.5 Case Studies

Extracts from the following case studies illustrate how this method has been used in practice. The case studies are given in full in Appendix 2 G and H.

Case Study 1: Securing the Keil Canal (Section Rendsburg East)

Network analysis was used to assess the effects of stabilising the banks of a 5km section of the Kiel Canal, in Germany. A series of flow diagrams were prepared which illustrated the impact relationships between the effects of various activities of the project, and each element of the receiving environment. Elements included ecosystem types, (such as floodplains and natural wetlands) and land use functions (social receptors).

Figure 3.4 illustrates the network of impacts initiated by one action of the channel widening process (the physical effect of channel widening) on one particular element of the environmental system (water quality). The process was subsequently repeated with each of the actions on the left of the diagram.

From the diagrams, it was possible to examine specific impact chains and select those of importance for further evaluation. For example, the proposed widening of the canal would increase the water surface and volume of water. These changes would affect the flow velocity which in turn would influence the water quality. Water quality then interacts with a highly complex ecological system. Changes in the relative size of the non-euphotic zone will alter bacteria populations and hence the balance of oxidising and decomposing material. This process has potentially major consequences for the fauna and flora of the canal.

The flow diagram showed a very complex system of indirect impacts and impact interactions, in particular illustrating the central functions of flora and fauna within the environment. The large number of interaction paths shown between the elements demonstrates that an impact on one of the key elements has a high potential to cause major change in an overall system.

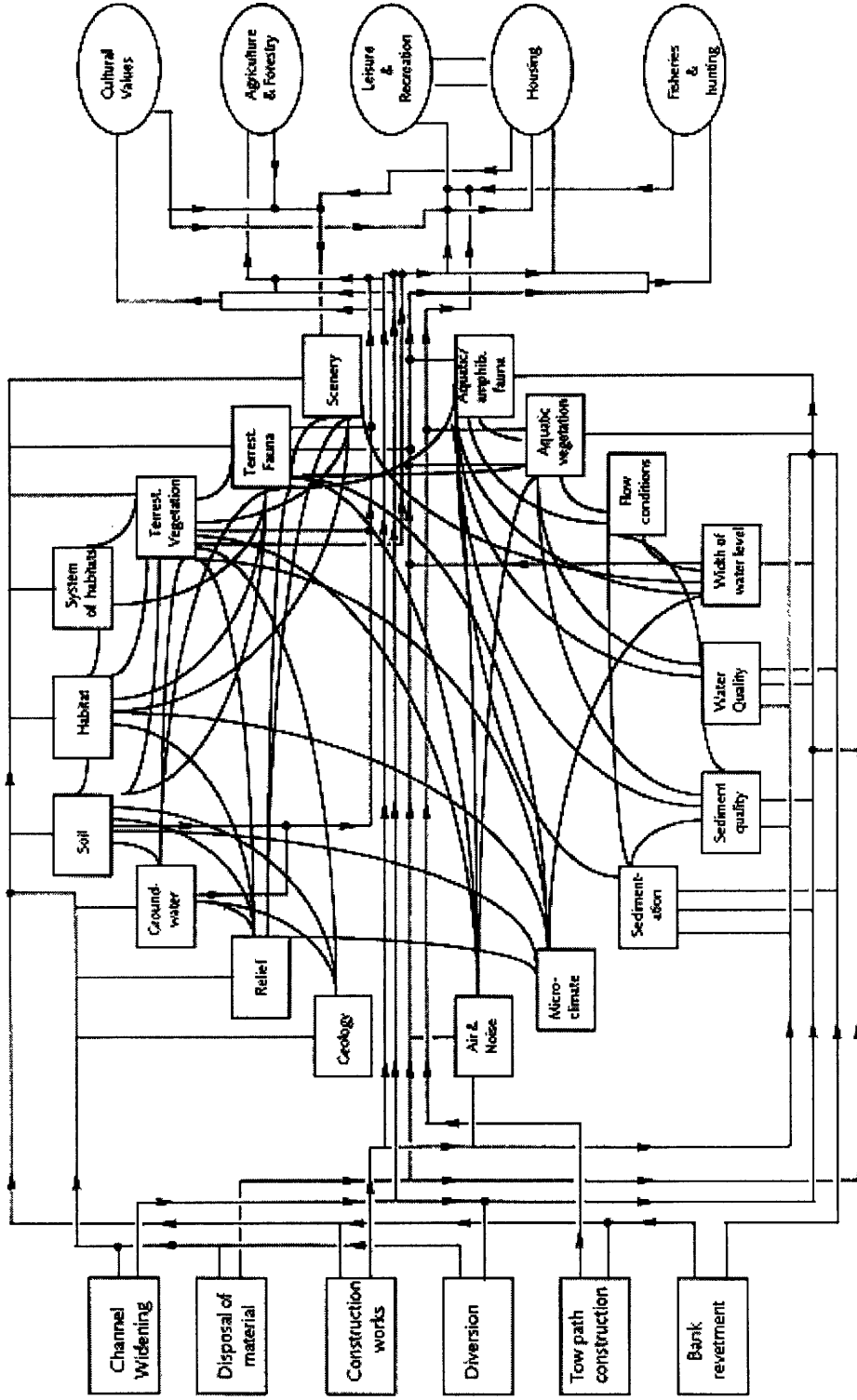

Adapted from Bundesanstalt für Gewässerkunde

Figure 3.4 System of Interactions: Effects of Channel Widening on Water Quality (Bundesanstalt für Gewässerkunde)

Guidelines For The Assessment Of Indirect And Cumulative Impacts And Impact Interactions

Case Study 2: B452 Reichensachsen Bypass, Germany

A number of route options were considered for the B452 Reichensachsen Bypass. Consultations and surveys were used to establish the baseline conditions of the study area, and the most sensitive receptors identified. These were surface and groundwater, landscape and flora and fauna, residential areas and historic features associated with the town.

A network analysis, based on defining interaction groups was used. This identified the links between ecosystem components which are sensitive to change in the environment and those that react to those changes. From this the impact pathways were defined. The network analysis was used to refine and extend the geographical boundaries of these sensitive areas in a way that allowed for the indirect impacts. For example, the network analysis for the wetland areas revealed that where the groundwater in the wetland would be affected this would in turn impact upon the soil, ecology, flora and fauna of the area. On this basis the extent of the sensitive wetland area was modified to take into account these interactions.

Once these spatial aspects had been redefined, four alternative route options were then overlain on the maps. For each route, the direct impacts which would be likely to occur were apparent, in addition to the indirect impacts resulting from interactions.

**Spatial Analysis and Network Analysis
of Ecosystem Interactions**

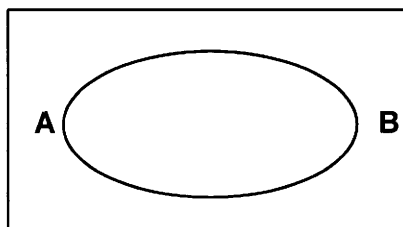

1. Define the study area for the assessment.

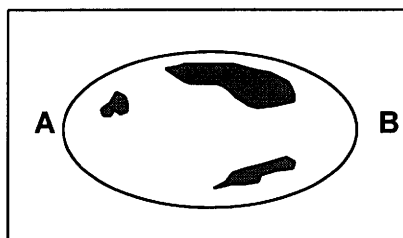

2. Undertake baseline surveys and consultations
Determine sensitive areas and ecosystem type
within the study area.

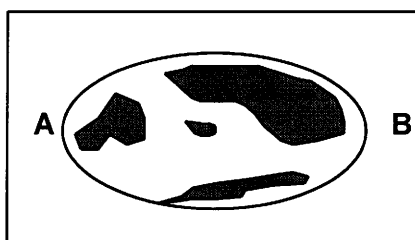

3. Carryout network analysis for ecosystem types
and refine the extent of the sensitive areas.

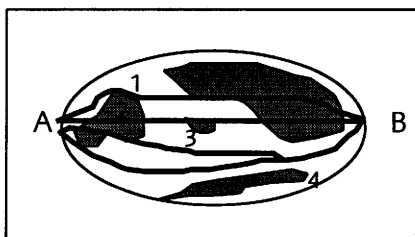

4. Overlay route options onto the study area. Asses
impacts of options.

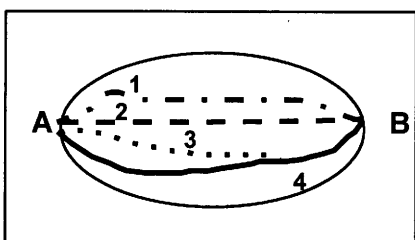

5. Determine the route option with the least
environmental impacts on the sensitive areas
i.e. Route 4.

Adapted from Sporbeck et al.

Figure 3.5 Method Stages used for Spatial and Network Analysis of Ecosystem.

3.8 Matrices

3.8.1 Introduction

Cumulative Impacts	Indirect Impacts	Impact Interactions	Identification	Evaluation
✓	✓	✓	✓	✓

Matrices are similar to checklists in that they use a tabular format for presenting information. The matrix is however, more complex and can best be described as a 2-dimensional checklist. Matrices can be used to evaluate to some degree the impacts of a project's activities on resources, and can also be extended to consider the cumulative and indirect impacts, as well as impact interactions on a resource. Matrices can not be used in themselves to quantify the actual significance of impacts; this can only be done using other methods. It is however possible to weight matrices to reflect factors such as duration, frequency and extent. They can also be used to score or rank impacts. If weighting or scoring are used, the criteria must be clearly set out. This approach relies on expert opinion to provide ranks/weights for each project with respect to each environmental effect.

By looking for patterns in the finished matrix, for example columns or rows with numerous impact strikes, it is possible to develop a clear picture of how impacts combine in a cumulative way on a particular environmental receptor. In doing so, probable impact interactions can also be identified.

Matrices can be used during the Scoping stages of impact assessment. They are also useful tools to summarise and present impacts within the Environmental Statement.

3.8.2 Simple Matrices

Simple matrices can be organised to cross reference the different phases of a project (e.g. construction, operation and decommissioning) against elements of the environment or sensitive receptors. Cumulative impacts may for example be considered in a separate column by including the effects of past, present and future actions on resources, alongside the range of effects caused by the action of immediate concern. The following is an example of a simple matrix using symbols. Numerical scores could be used equally well to show the approximate scale or magnitude of the impact.

Potential Impact Area	Proposed Action			Past Actions	Other Present Actions	Future Actions	Cumulative Impact
	Construction	Operation	Mitigation				
Landscape	*	**	+			*	**
Ecology	**		+	*			**
Water Quality	*			**			**
Land Use	***	***			*	*	***
Cultural Heritage	*			**		*	***

*low adverse effect ** moderate adverse effect ***high adverse effect
+ beneficial effect

Table 3.6 Example of a Simple Matrix

3.8.3 Weighted Matrices

By introducing weighting into a matrix it allows the ranking of impacts. It also provides a tool for assessing complex effects. However, use of such complex approaches may make interpretation of the results difficult for others.

Weighting an impact will be subjective and it is therefore important that the assessment explains assumptions made and the criteria used. Weighted matrices allow the magnitude of impacts to be used quantitatively. A weight is assigned to each environmental component, indicating its importance. The impact of the project on each component is then assessed and scored. Weighting or scoring can also be used to give an overall total score for the project or alternative options. Extreme caution should be practised if these weights are to be used additively during the comparison of project options or to determine combined impact values as the rankings do not work in a strict additive way. The following is an example of a weighted matrix developed to compare alternative sites.

Environmental Component	A Relative Weighting (Total 100)	Construction		Operation	
		B	A x B	B	A x B
Air	10	3	30	2	60
Water	35	6	210	6	210
Noise	8	3	24	8	64
Landscape	10	5	50	1	10
Ecology	27	2	54	4	108
Total Cumulative Impact	100		368		452

A = relative weighting of environmental component (total 100)
B = Score of impact

Table 3.7 Example of a Weighted Matrix

3.8.4 *Stepped Matrices*

Stepped matrices are a more advanced type of matrix that considers how the various activities of a project relate to the environmental resource or parameter. It shows resources against functions of the environment. This approach therefore shows how one action can impact on a resource, which can then cause changes on another resource. Table 3.8 is an example of a stepped matrix developed by Froelich and Sporbeck for a road scheme.

3.8.5 Advanced Network Matrices

This is a complex method which can be considered as both a stepped matrix and a network. It identifies the activities of the project and assesses the impact on the resource (the matrix part of the method). However this is then considered in greater depth (the network part of the method). It is therefore a tool which is flexible in its use.

This tool provides a way of linking the matrix and the cause and effect impact chains. It integrates into one diagram a matrix and a network of consequent impacts. The initial impact can be followed through successive stages of cause and effect until it reaches what is considered the final impact. The following is an example of such a matrix:

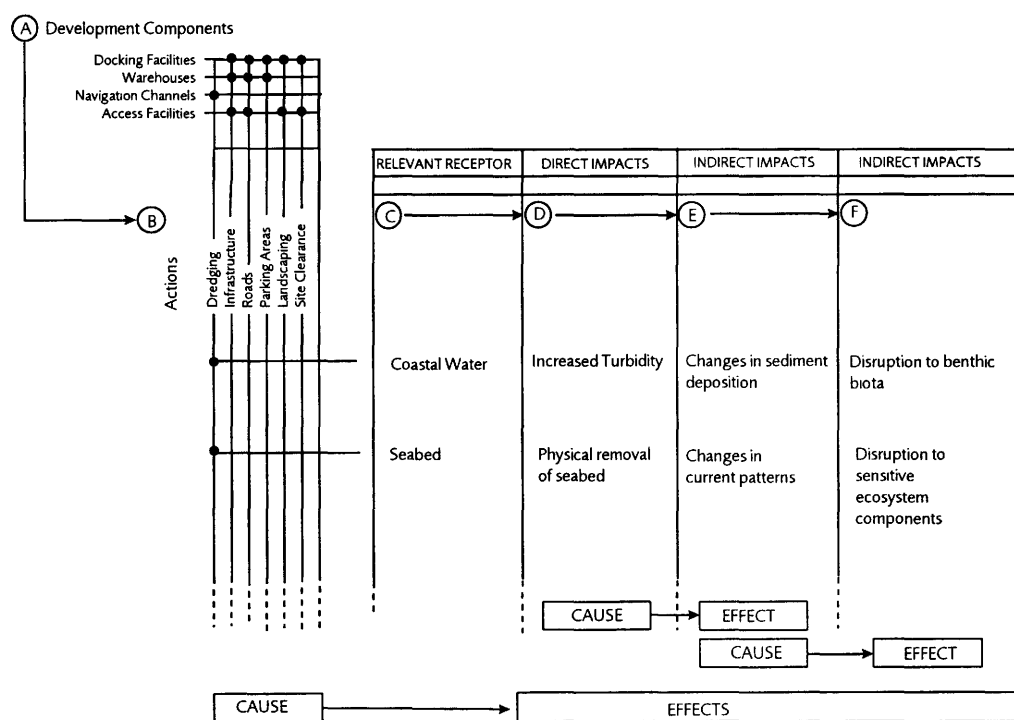

Figure 3.6: An advanced Stepped Matrix used for a Hypothetical Port Development. (Adapted from Sorenson 1971)

Although this tool provides a more comprehensive approach to impacts identification than many of the simpler methods, it is still not quantitative. It does not identify the magnitude of the impacts or their interrelationships, and neither does it assess the significance of the impacts. In addition, compilation of such a matrix can be time consuming. However, its main advantage is its ability to trace the indirect impacts of proposed developments.

3.8.6 *Advantages and Disadvantages*

Using a standard matrix format will help to ensure that potential impacts are not overlooked. Matrices provide a good visual summary of impacts. They can be adapted to report indirect and cumulative impacts as well as impact interactions in a comprehensive format.

Matrices are a useful tool for presenting results, for example from subjective assessments, or from numerical modelling. This is because they are easy to interpret.

Matrices can be designed to include the potential for interactions and can combine the impacts from various actions or from a number of projects. They can also be used to compare alternative options. Matrices can however be complicated and cumbersome to use.

3.8.7 *Application of the Method*

Developing a matrix will be dependant upon a number of activities. The steps that could be followed are:

- consider and list the activities associated with project;
- identify and list the sensitive resources;
- select an appropriate matrix depending on the nature of the assessment. A simple matrix may be appropriate for the Scoping stage or alternative site assessment. For a more detailed assessment the sensitivity of the receptors and the nature of the activities associated with the project will be important factors. A complex matrix is unlikely to be appropriate for a simple project. Conversely a project in a particularly sensitive area may benefit from the use of a more complex matrix;
- identify where impacts arising from activities may occur on the matrix;
- identify cumulative impacts by identifying if a number of different activities (including those from other developments) impact on a single resource or receptors.
- for more complex matrices, extend the matrix to give cause and effect relationships or impact chains.

Matrices can be applied to a range of projects and environmental conditions by selecting a matrix which is appropriate; for example, a simple matrix would be suitable for scoping or option assessment. A more complex matrix would be

better suited to a larger scale project or a project in a particularly sensitive location. The choice of matrix must therefore be appropriate to the nature of project and the receiving environment. Matrices can be adapted and can be applied to consider both physical and socio-economic impacts.

3.9 Carrying Capacity or Threshold Analysis

3.9.1 Introduction

Cumulative Impacts	Indirect Impacts	Impact Interactions	Identification	Evaluation
✓	✗	✗	✗	✓

Carrying capacity analysis, sometimes also referred to as Threshold Analysis, is based on the recognition that natural thresholds exist in most natural and man-made systems. The recognition and use of these inherent limits can be useful when considering cumulative impacts from development.

It can also be used to test the sustainability of a project. In an ecological sense the carrying capacity could be the level of environmental stress which populations or ecosystem processes can sustain without permanent damage. In a social context, it could mean the limits for the concentration of development within a particular area that the infrastructure can support.

In order for carrying capacity analysis to be effective, limiting factors must be selected which best represent the environmental parameter of most concern for a particular resource. For example, the area of remaining forest area within a valley could be the most important factor in determining whether the number of individuals of a certain bird species reaches their minimum viable population. The minimum viable amount of forest which can support the bird population becomes the threshold against which the impact of deforestation associated with the project is assessed.

Thresholds can be derived from expert opinion or surveys. Mathematical equations can sometimes be used to estimate the critical level. Thresholds can also be set by regulatory authorities. Some examples of thresholds are:

- emission standards (e.g. air and water quality);
- wildlife populations;
- recreational carrying capacity (e.g. total number of visitors a site can support).

By identifying these limits, projects can be systematically assessed in terms of their additional environmental impacts in relation to carrying capacity. The

threshold approach is therefore highly applicable to the evaluation of cumulative impacts.

3.9.2 Trends Analysis

Trends analysis is intrinsically linked to carrying capacity analysis. It is the interpretation over time, of the status of an environmental resource and is, therefore, an analysis of the results of past actions.

The trends analysis could include trends data presented numerically such as fish stocks or numbers of endangered species, or the pattern of abundance and distribution of habitats, such as ancient woodland.

In most cases the trend is determined relative to a critical environmental threshold. In practice, factors such as the status of resources, ecosystems and human communities over time are the most commonly encountered subjects. The study of these usually results in the graphical projection of past and future conditions.

Figure 3.7 shows the trend in the regional winter populations of Elk in Finland. From this information, an impression of the extent that the different populations would be affected by a particular project could be determined.

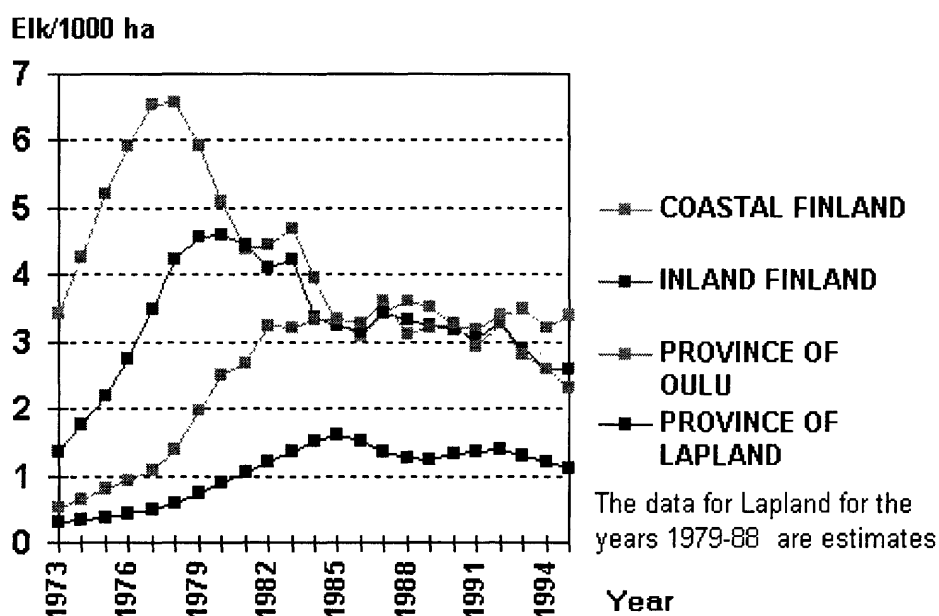

Figure 3.7 Regional Winter Populations of Elk in Finland Between 1973 and 1995. (source: Game and Fishing Research Institute, Finland).

It is the ability of trends analysis to quantify the impacts of development over time, leading to the establishment of a pattern, which can assist in the assessment of cumulative impacts. For example, trends analysis may identify if a resource has already been significantly affected in the past and as a result is now near a state of total loss. By identifying cause and effects in the past it will

also assist in predicting impacts from future actions. Numerical analysis could also be carried out in line with an historical study to identify any peaks or troughs.

Adverse effects caused by a number of projects, each with similar impacts can be identified, and appropriate environmental baselines can be established based on natural environmental thresholds. Trends analysis can be used by planning authorities to monitor the progression of development in an area and to limit its growth where necessary.

The presentation of trends can be fairly simple, e.g. a line graph, or quite complex, e.g. using 3-dimensional graphics or video simulation.

3.9.3 *Advantages and Disadvantages*

Regulatory thresholds are generally more commonly used when considering the cumulative impacts of emissions from a number of developments. This is because the threshold is easily established, the background data is more readily available and details of emissions from other developments are available, particularly if they are emissions that have had to be licensed. It must be recognised though, that there are often situations where it is not possible to obtain the relevant data on other developments.

When considering the threshold or carrying capacity whether in relation to social or ecological indicators, obtaining the relevant information, such as the threshold value and the influence of other developments, is not always easy. Often, unless there is a detailed ongoing monitoring programme of the particular resource or environmental element, there will not be suitable information in order to assess the additional impact of the proposed project.

In cases where environmental data is available over long periods of time, trends analysis can assist greatly in the quantification of cumulative impacts. However, data sets which span an appropriately long time period are not always available. The most complete sets of data usually exist for natural ecosystem parameters, such as species populations, due to a long standing interest in nature conservation. In cases where there are gaps in data, it becomes important to use appropriate statistical methods to ensure the proper interpretation of trends.

3.9.4 *Application of Method*

If using the threshold method to determine the cumulative impacts of a number of developments on a particular resource or element of the environment, a number of steps should be followed:

- establish the baseline conditions;
- identify other actions where impact zones will overlap with the project including their emissions and activities;
- assess impacts against the threshold set

One way of using threshold analysis to analyse cumulative impacts is to formulate a checklist which includes thresholds of concern. Environmental receptors can be listed and a threshold of concern entered beside each one. The project can then be assessed on the basis of how many times it exceeds the thresholds of concern. Alternative project options can also be considered in the same way along with the impacts arising from a number of projects considered together. Using a checklist, as a way of determining where projects may exceed a threshold, is described in more detail in Section 3.5.

Carrying capacity or threshold analysis can be applied to physical and socio-economic impacts. They can be applied to a range of projects and environmental conditions but are best suited where regulatory thresholds exist. Most often these methods are used for natural ecosystem parameters, such as species populations. The analysis can be adapted to suit a particular project. A line graph would be suitable for a small scale project but 3 dimensional graphics may be appropriate for a complex project or a project in a sensitive environment.

3.9.5 Case Studies

Extracts from the following case studies illustrate how this method has been used in practice. The case studies are given in full in Appendix 2 I and A.

Case Study 1: Extension to Killingholme Power Station, UK

The project concerned an extension to an existing power station at Killingholme. There is also another power station in close proximity operated by a different company. When consultations were carried out for the proposed extension the issue of the cumulative impacts of noise from all three power generating facilities was raised.

A threshold of 44_{L10} dB(A), imposed by the environmental health department of the local authority, was already in existence which should not be exceeded by the combined noise levels of the two existing power stations. This threshold was also imposed on the extension. A cumulative noise impact assessment of the three facilities was carried out and the project designed so that the threshold would not be exceeded.

Case Study 2: Nestos River Project, West Thrace, Greece

The project addressed the cumulative impact of the construction of three dams on the Nestos River. The study area was based on the hydrological basin of the river.

During data collection the project co-ordinator identified that previous and current land use practices were impacting upon the delta system - for example pumping of groundwater for irrigation was resulting in increased sea water intrusion. The project team therefore identified the need to establish baseline conditions and assess possible impacts taking into consideration these trends.

3.10 Modelling

3.10.1 Introduction

Cumulative Impacts	Indirect Impacts	Impact Interactions	Identification	Evaluation
✓	✓	✓	✗	✓

There is a wide range of models which can be used in the assessment of impacts, including indirect and cumulative impacts and impact interactions. Models can be relatively simple, considering one aspect of the environment, or complex, predicting the behaviour of a natural system.

Modelling is an analytical tool which enables the quantification of impacts which can affect the environment by simulating environmental conditions. Often models use computer technology to predict the chemical or physical effects of a particular action within the environment.

A mathematical model lends itself to the spatial and temporal analysis of aspects of the environment such as air and water quality, water volume and flows, noise levels and airborne deposition on soils and vegetation.

Other types of model include socio-economic models, species habitat models and expert systems which allow the impact of a project to be determined through a programme of decisions.

3.10.2 Air Quality Modelling

There are a number of different models available for assessing the impact of a project on air quality. They can be used to consider the cumulative impacts of a number of projects in an area, the interactions between emissions and enable some assessment of indirect impacts resulting from emissions.

For example, the case study prepared below for Killingholme Power Station, shows how two different models were used to assess the potential cumulative impacts and indirect impacts of a project.

3.10.3 Water Quality Modelling

Dispersion models are available which can assess the cumulative impacts of a particular pollutant from a number of different point sources and simulate the dispersion of that pollutant under different tidal or flow conditions. The model can be run to establish what additional impact certain sources of pollutant will have, relative to the overall water quality criteria. Typical factors that are modelled are dissolved oxygen, coliform bacteria, sediment or chemical concentration. Data such as tidal conditions and flow regimes however, will be needed to undertake such assessments.

3.10.4 Noise Modelling

There are existing models to predict noise levels for a development which can be adapted to consider the cumulative impacts of noise from more than one source.

An example of this is a model used for the E18 Highway in Finland to assess the noise levels if the new road were to intersect the existing road or if they were to be routed close to one another.

Factors such as the wind direction and speed, details of the topography of an area, the project location and any mitigation measures which may be employed, should be included in the model.

3.10.5 Ecological Modelling

The cumulative effects of impacts on species populations or habitats can be examined using models which represent component processes of natural ecosystems. Simulation models provide a simplified representation of dynamic, complex systems which often have many interacting components. As with other models, they are extremely consuming in terms of time and resources. The accuracy of simulation also depends largely on the environmental data available and the relationships between factors which are assumed within the model.

Applications of ecological modelling which have been used successfully are mainly in the field of forestry. In these cases the fragmentation of forest has had a certain discernible effect on biodiversity, populations of a particular species or stream bed conditions within the area. Variables considered by such a model might include the effect of habitat loss, genetic isolation and edge effects. However, the methods are equally applicable to numerous other ecosystems where models exist.

Because simulation models focus on cause and effect linkages, they can generally differentiate additive and interactive processes. As such they offer

one of the best prospects for analysing specific pathways of cumulative environmental change.

3.10.6 Visual Modelling

Modelling of the cumulative visual impacts of a number of projects in one particular area can be achieved through the creation of photomontages. These can be generated manually or on computer and can provide an idea of the overall impact on the landscape. The assessment will, however, be subjective as it is not possible to quantify the impact on the landscape.

3.10.7 Advantages and Disadvantages

The accuracy of the model is only as good as the baseline environmental data which is used to construct it and input into it. It is difficult for any model to realistically address every intricacy of the natural system. Models also have a reputation for being pessimistic in their outcome and data can be manipulated relatively easily. This should be considered when reviewing the model output as there may be a likelihood of impacts proving to be less severe than predicted.

Developing a new model is generally demanding in terms of cost, expertise, time and possibly data. For this reason it is best suited to larger and more complex projects. It is therefore often more appropriate to use a model that has been used previously and is therefore established and accepted.

Noise, air dispersion and hydrodynamic models are well developed and generalised in form and are therefore suited to the analysis of cumulative impacts on a routine basis.

Modelling results can be combined with overlay techniques effectively, for example to assess different options. Modelling is also a particularly useful tool for simulating impacts over time and geographically.

3.10.8 Application of the Method

In general the steps set out below can be followed for modelling of most environmental factors:

- establish baseline conditions and any regulatory standards;
- identify the model that is suitable for the assessment and which can consider emissions/impacts from other projects;
- collect the data necessary for input into the model, e.g. wind speed, wind direction, topography, mitigation measures;
- collect data on emissions from the project and the other actions which are to be taken into account in the assessment;

- run the model for the different scenarios to be considered to enable comparison;
- assess the indirect, cumulative impacts or impact interactions against the baseline and any regulatory standards.

Modelling can be applied to a range of project types and environmental conditions. Most often models are used to predict impacts on specific physical environmental parameters, although for some projects they can be used to predict socio-economic impacts.

Models can be adapted to suit a particular project with simple models being used for smaller scale projects and more complex models for large scale and complex projects.

3.10.9 Case Studies

Extracts from the following case studies illustrate how this method has been used in practice. The case studies are given in full in Appendix 2 I, C and J.

Case Study 1. Killingholme CCGT Power Station Extension, UK

An Environmental Statement was prepared to assess the effects of constructing an extension to the existing Power Station at Killingholme, Humberside, UK.

A potential cumulative impact identified during meetings with consultees was deposition of airborne salt on new landscaping and other sensitive vegetation caused by the new power station in addition to that already produced by the existing power station. Emissions from cooling towers include saline carry-over droplets, which will have the approximate composition of the estuarine water that is used in the cooling process. Chase Hill Wood, to the east of the existing power station is an oak woodland but designated as a Site of Nature Conservation Interest due to the colony of purple orchids which it supports.

The computer model VISPACT was used to assess the distance that the saline plume was carried. This model predicted the frequency with which a water plume would form and also the frequency with which the plume may touch the ground (ground fogging), and therefore cause salt deposition. The cumulative effects of both the existing and new power stations and the adjacent National Power development were considered in the same model. The results showed that deposition levels of the combined emissions from the existing and proposed extension would not increase over existing levels and were shown on a contour map (Figure 3.8). The assessment also used operational experience in concluding that ground fogging was not found to occur more than a few hundred metres from low-level towers. The effects on vegetation were therefore taken to be negligible. No noticeable effects on the salinity of the soil would be expected from the forecast deposition rates, and therefore no adverse impacts were predicted on the colony of purple orchids.

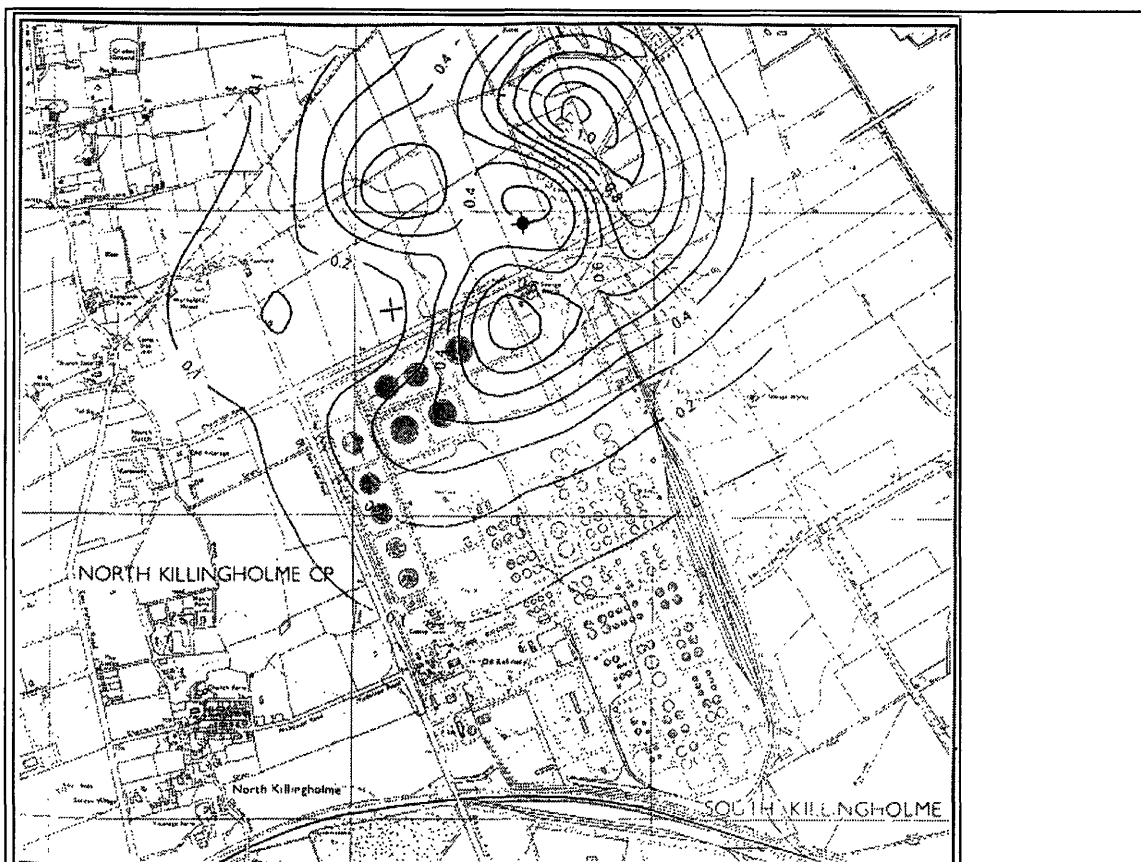

Fig.3.8 Predicted Salt Deposition from Existing and Planned Cooling Towers at Killingholme Power Station (Powergen 1995)

To fulfil the requirements of the Integrated Pollution Control application, and the Environmental Assessment, the effects of NO_x and SO_2 emissions were assessed. The assessment was undertaken based on Guideline and Limit concentrations for nitrogen dioxide and sulphur dioxide which have been set in EC Directives and are implemented in the UK through the Air Quality Regulations 1989.

The assessment used a computer model, the UK-ADMS (United Kingdom - Advanced Dispersion Modelling System) to predict the concentrations of nitrogen dioxide and sulphur dioxide at ground level as a result of the operation of the proposed plant extension. As part of the assessment additional model runs were carried out for the two existing power stations so that the relative increase in NO_x and SO_2 could be determined. The model took account of local weather conditions, and geography, and was also run to determine the dispersion during specific meteorological conditions.

The predicted increase in concentrations and dispersion of NO_x and SO_2 were found to be within the guideline values, even when taking the cumulative effects of the emissions from the proposed extension and the two existing power stations.

Case Study 2: Highway E18 Lohja - Salo, Finland Noise modelling was used to assess the combined impact of noise where the proposed motorway route would run alongside the existing road for part of its length, passing a number of residential areas. The predicted noise levels from both roads were modelled to establish where there would be a significant increase, both with and without noise attenuation barriers. The results of the assessment were illustrated on noise contour maps, the contours representing the predicted noise levels from the roads. Using this method, more than one scenario could be considered e.g. with or without mitigation measures, or at different levels of traffic flow.

Case Study 3: Rethimno City Waste Water Treatment Works, Crete

Data was collected on existing discharges to the coastal environment. This included data on discharges from a nearby tannery and abattoir.

The Environmental Assessment used a computer model to predict the impact of the discharges on the local beaches under various conditions. The model took into consideration the impact of pre-treatment at the abattoir and tannery, with transfer of waste from these sites for treatment and discharge at the new Waste Water Treatment Works site. The model was used to compare the current discharges to the proposed future situation with the new Waste Water Treatment Works.

4. SCOPING

4.1 Introduction

4.1.1 *The Importance of Scoping*

Scoping is a well established principle in EIA and much guidance has already been produced on this subject. The purpose of this section of the Guidance on indirect and cumulative impacts and impact interactions is to suggest how the assessment of these impact types can be integrated into the scoping process for a project.

The objective of undertaking scoping is to identify issues that are to be addressed in the EIA and to focus the assessment on the most potentially significant impacts. It will also assist in consultations, identifying the requirement for baseline surveys and studies, and in determining appropriate methods for the assessment. Scoping must commence early in the EIA process, at a stage when alternatives can still be considered and mitigation measures can still be incorporated into the project design.

Scoping is generally accepted to be one of the main factors in a successful EIA. It is an iterative process that will focus the assessment and the range of issues to be considered.

4.1.2 *The Importance of Consultation*

The developer is reliant, amongst others, upon the local authorities for obtaining information and data for the assessment of potential indirect and cumulative impacts as well as impact interactions. It is therefore strongly recommended to the developer to make use of the provision of the amended EIA Directive to request information on the scope of the assessment and on future activities foreseen, so that these impacts can be properly assessed.

The competent authorities should then advise the developer in establishing the boundaries of the assessment for indirect and cumulative impacts as well as impact interactions.

4.1.3 *The Requirement for Scoping*

Although there is no requirement for scoping under the terms of the EIA Directive (85/337/EEC), the amended Directive (11/97/EC) does require the competent authorities, at the request of the developer, to give opinions as to what should be addressed within an EIA – essentially to give a scoping brief. Consultation with other interested parties should augment these opinions. However, any opinions obtained from the competent authorities should not be considered as prescriptive and do not preclude the authority from requiring the developer to submit further information at a later stage.

4.1.4 *Scoping for Indirect and Cumulative Impacts, and Impact Interactions*

The general principles of scoping can readily be applied to the assessment of indirect and cumulative impacts and impact interactions. Throughout the various stages of the scoping exercise it is important for the practitioner to be conscious of the need to address such impacts as appropriate to the project. By being aware of the potential for such impacts at an early stage the collection of baseline data, assessment methods and resources required can be tailored to include for these. Decisions made at the scoping stage of the EIA are of fundamental importance to the project as they determine, in the most part, what will follow.

4.2 *The Scoping Process*

This section provides guidance on how the assessment of indirect and cumulative impacts, and impact interactions can be incorporated practically into the scoping of any project. More detailed information is included in Chapter 3 which describes the 'tools' or methods that are mentioned in this section.

The key elements of the scoping process covered in this section are:

- setting geographical and time frame boundaries for the assessment;
- mapping the boundaries;
- collecting the baseline data;
- assessing the impacts;
- consideration of alternatives.

4.2.1 *Setting the Boundaries or 'Limits' for the Assessment*

An important factor that needs to be considered when scoping the proposed assessment of indirect and cumulative impacts and impact interactions is setting a boundary or 'limit' for the project. Boundaries cannot be prescriptive and must be drawn up on a project by project basis. The process of determining such boundaries should involve the project team and, if appropriate, interested parties at the earliest stages in the scoping process. There are basically two types of boundary that need to be considered:

- a geographical or 'spatial' boundary
- and the temporal or 'time frame' boundary.

Geographical or 'Spatial' Boundaries

Indirect and cumulative impacts and impact interactions may well extend beyond the geographical site boundaries of the project. Determining the geographical boundaries will therefore be a key factor in ensuring the impacts associated with a project are assessed comprehensively wherever possible.

Geographical boundaries will depend on:

- the nature of the project;
- the nature of the impacts;
- sensitivity of the receiving environment;
- availability of data;
- natural boundaries.

For example, the geographical boundary for an air quality assessment of a sewage treatment works may be determined by the presence of a residential area. In comparison, the geographical boundary for impacts on traffic as a result of a new major industrial development may cover a much wider geographical area based on the local or even regional road network.

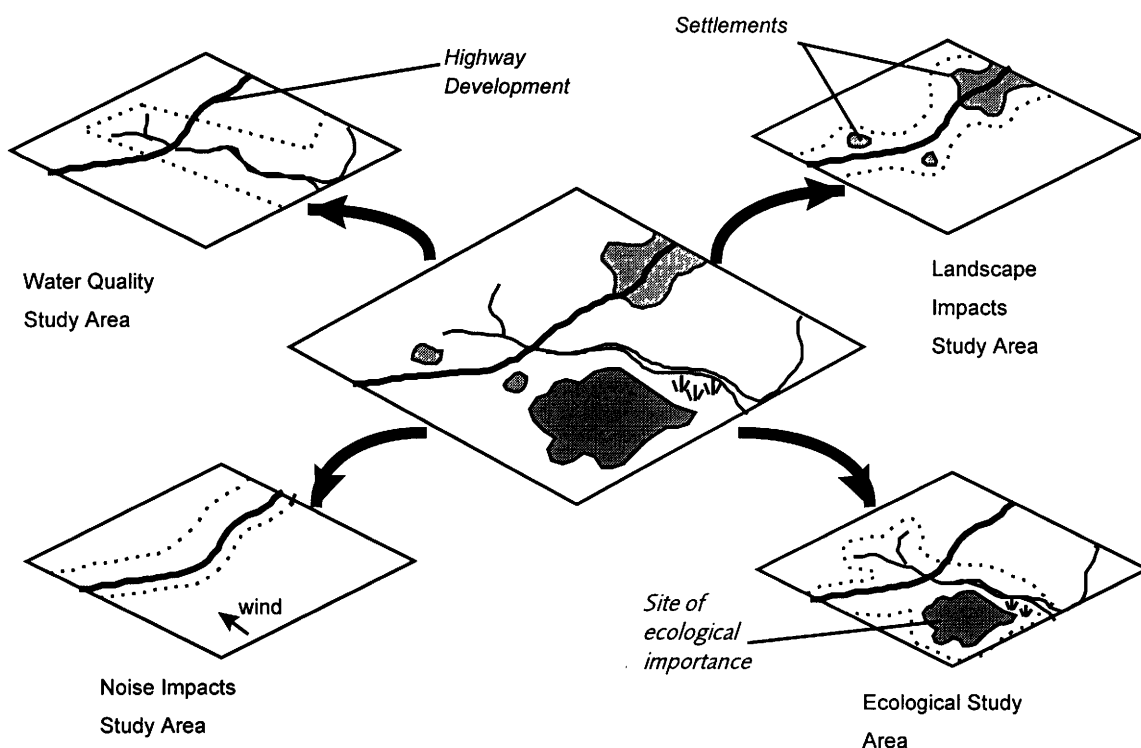

Figure 4.1 The Selection of Geographical Boundaries for Impact Study Areas.

Additional data may need to be gathered to cover wider spatial boundaries, taking into account the potential for impacts to affect areas further away from the site than if just the direct impacts were considered. Consideration should be given to the distance that an impact can travel, and any interaction networks.

The appropriate boundary for the assessment should also depend upon the nature of the impact and the resource being affected. Where possible, natural boundaries (such as river catchments) rather than administrative boundaries should be used.

To assist in identifying where overlaps occur in study areas for different resources, and where cumulative or indirect impacts or impact interactions may arise manual overlays or GIS systems can prove to be useful tools. These tools are explained in greater detail in Chapter 3.

Considering the Past, Present and Future

Consideration should be given to historical or potential future impacts which may affect the assessment. Activities in the past, present and future can all have a bearing on the project being assessed and will influence the time frame set for the EIA. Setting time frames or 'boundaries' will allow for the inclusion of past and future developments which could lead to indirect or cumulative impacts or impact interactions.

Time boundaries will depend upon:

- historical use of the area, e.g. industrial activities or landfill;
- information available;
- the local, or national planning horizons for future development;
- lifespan of the project from construction to decommissioning.

These are considered in more detail below.

In practical terms, the extent of the assessment in terms of how far into the past and into the future will be dependent upon the availability and quality of information. Past activities can often be identified from historical maps, present activities from current maps, and future development activities from development plans.

How far back in time information needs to be considered will depend on the project and the historical use of the area. For example, in an area where there has been a history of long term pollution from industrial activities or landfill it may be necessary to set the time limit as far back as 50 or even 100 years. Setting the time boundary in terms of future developments can be based on information provided from the relevant planning authorities during consultation and from information contained within development plans produced by local or perhaps national authorities. In setting the future time boundary it is suggested that in general, beyond 5 years there is too much uncertainty associated with most development proposals. It is therefore recommended that in the majority of cases the limit does not exceed 5 years into the future.

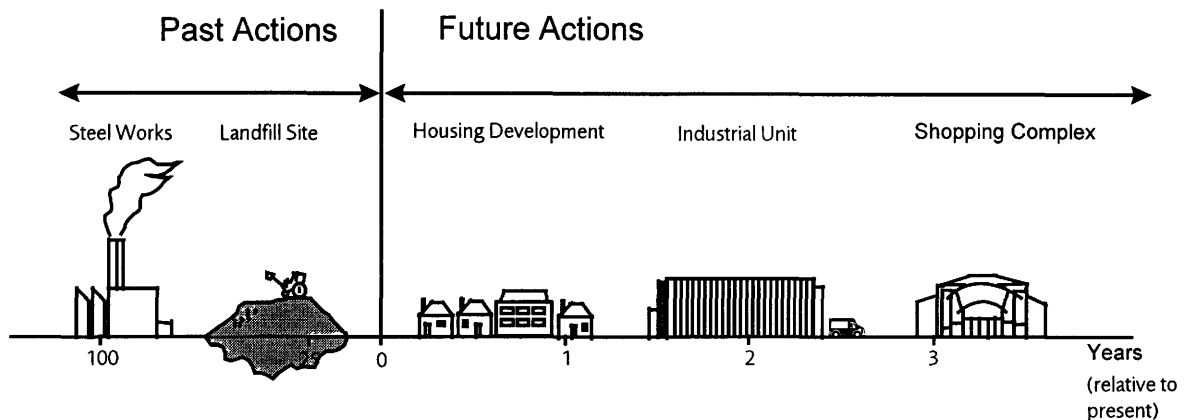

Figure 4.2 Time Chart Illustrating Past and Future Development which could be Included when Considering the ‘Time Boundary’ of a Project.

The lifespan of the actual project, from construction through to decommissioning and restoration, may be considered reasonable upon which to base the assessment of these impact types, particularly where there may be a set lifespan, for example for a quarry or landfill. However, this can prove to be more difficult for projects which do not have such specific lifespans such as roads.

There are limitations in defining the area and time boundary that would be affected by the project. For example, it is only reasonable to consider current events and those that will take place in foreseeable future. Furthermore, the assessment can only be based on the data that is readily available. There needs to be a cut off point at which it can be said that the impacts cannot be reasonably attributed to the project. This should be established. For example, this may be the point beyond which there can no longer be any reasonable mitigation. Within the Environmental Statement the cut off point used for the assessment should be defined.

4.2.2 Mapping the Boundaries

Mapping geographical and time boundaries can be a useful tool for the practitioner to show areas of potential impact which may overlap, and therefore where indirect and cumulative impacts or impact interactions may occur.

For example, the geographical boundaries can be mapped to indicate which areas will be considered in the assessment for each topic, or environmental parameter. In considering the ‘time boundary’ past, present and future land uses can be mapped in a similar way. This mapping exercise can be a relatively simple method, for example using a manual overlay technique with transparent sheets or alternatively, for a more complex project, a Geographical Information System (GIS). (See Chapter 3).

Professional judgement will be required to interpret the information and determine the potential for indirect and cumulative impacts and impact interactions, and in deciding which should be investigated further. At this stage

it should be possible to discount activities for which the time scales do not coincide or those which would affect a different resource. Even where there has been shown to be overlapping of boundaries or other activities close to the proposed project it may not be necessary to include them in further assessment.

4.2.3 *Collecting the Baseline Data*

During the scoping stage the practitioner will need to consider what baseline data will be required. Some baseline data will be collected at this stage which will assist with identifying potential impacts and sensitive receptors. Deficiencies in data will also be identified resulting in requirements for any additional surveys.

The important factor with respect to indirect and cumulative impacts as well as impact interactions will be to determine at this early stage in the project if additional data needs to be collected or surveys conducted to allow assessment of these impact types.

4.2.4 *Consideration of Alternatives*

Consideration of alternatives is not specifically required to be reported within the Environmental Statement by EIA Directive 85/337/EEC. However, the 1997 amendment to the Directive (97/11/EC) requires a developer to submit '*an outline of the main alternatives studied...and an indication of the main reasons for his choice, taking into account the environmental effects.*'

Consideration of alternatives is usually undertaken at the feasibility stage of the project. Alternative options can often apply to the development site or the process to be chosen. The decision about the choice of site is based on consideration of as many types of environmental impacts as possible for which there is data available. Other factors to be considered include cost effectiveness and potential for mitigation.

Suitable tools for the consideration of alternatives are:

- expert opinion;
- checklists;
- consultations and questionnaires;
- spatial analysis;
- network & systems analysis;
- matrices;
- carrying capacity or threshold analysis.

Details of how to use these 'tools' to consider alternative options are included in detail in Chapter 3.

4.2.5 Identifying the Impacts

The methods and approaches as briefly described here are intended to give the practitioner an insight into how indirect and cumulative impacts and impact interactions can be considered and identified as part of the scoping process. Full details of the methods described are given in Chapter 3.

Each individual project will, because of its nature and location, result in different potential direct impacts. Similarly, this will also be the case for indirect and cumulative impacts as well as impact interactions. The potential impacts will result from a combination of factors such as the sensitivity of the site and its surroundings, and the nature of the proposed development. As with the assessment of direct impacts, the practitioner will need to consider the potential impacts identified and determine which of those impacts are significant, requiring a more detailed assessment as part of the full EIA.

There are a variety of well documented methods used to identify impacts, the most common being checklists and matrices. These standard scoping methods can be adapted and expanded to allow for the consideration of indirect and cumulative impacts, and impact interactions.

Suitable tools for the identification of indirect and cumulative impacts and impact interactions are:

- checklists;
- consultations;
- mapping overlay;
- network and systems analysis;
- expert opinion.

The potential for non-direct impacts may be identified during consultations with statutory and non-statutory consultees. Statutory bodies may, for example, be able to advise on planned future development which could result in indirect and cumulative impacts and impact interactions.

An alternative method for identifying such impacts is network or systems analysis, which considers the interrelationships between direct impacts of a project. A mapping overlay method described in Chapter 3 is also a useful technique.

Although often not considered a 'method' as such, expert opinion is the key to the successful use and interpretation of all aforementioned approaches. Expert opinion is often used itself to identify indirect and cumulative impacts and interactions.

4.2.6 *The Way Forward – Assessing the Impacts*

The scoping exercise undertaken will have identified the potential impacts considered to be significant and which require further assessment. At this point in the EIA it will be necessary to decide which 'tools', techniques or methods will be used to assess and evaluate the significance of the impacts. Guidance on different methods is given in Chapter 3.

The potential for an indirect or cumulative impact, or impact interaction may have been identified during the scoping study, however there may be a lack of available data for a detailed assessment. A value judgement will need to be made at this stage of the assessment to determine whether collection of the additional data can in fact be justified. In such instances the following factors need to be taken into account in the decision making process:

- project costs;
- programme;
- requirements of the project developer;
- and requirements of the determining authority.

However, the aim should always be where reasonable and appropriate to carry out an assessment, using the best available data or techniques at the time. This will at least allow the impact to be considered as part of the decision-making process. It will also enable the issue to be addressed in the project design and through development of mitigation measures, where necessary.

4.3 **Summary**

This Chapter on Scoping has demonstrated the value of considering the assessment of indirect and cumulative impacts and impact interactions at the early stages of the project. It has also suggested useful tools and methods which can be adapted to suit the needs and circumstances of the project. Figure 4.3 below illustrates the steps in the scoping process.

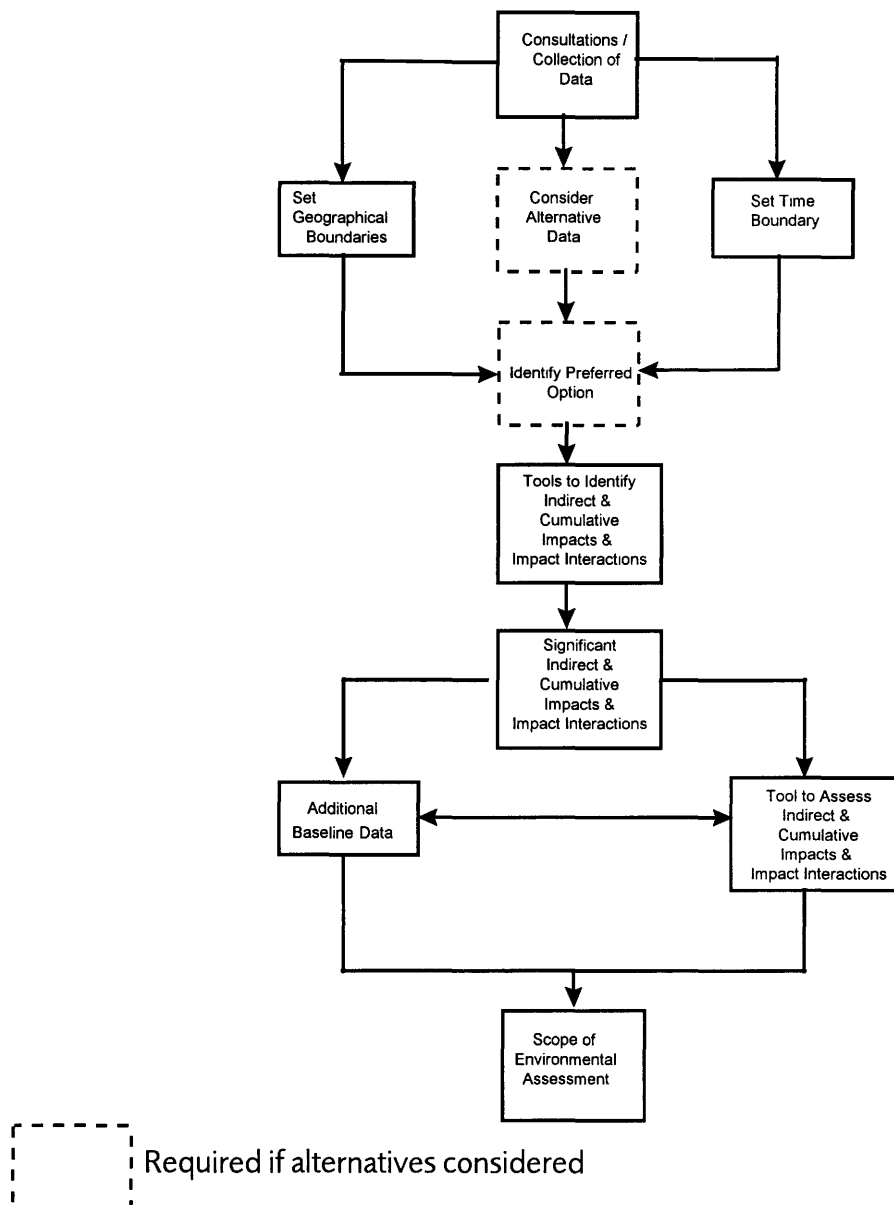

Figure 4.3 Flow Diagram Showing the Scoping Process and How it can Include Cumulative and Indirect Impacts, as well as Impact Interactions.

A Scoping Report which draws together the various stages and approaches described and shown above will prove a useful document. It can be used if appropriate to circulate to consultees and the public so that they can comment on the scope of the EIA. Ideally it should form the Terms of Reference for the required EIA studies, giving a clear indication of the scope and approach to be adopted.

It has been identified where the scoping exercise can be used or expanded to take into consideration the assessment of indirect and cumulative impacts, and impact interactions by the following:

- as an integral part of alternative option assessments;
- through consulting with statutory and non statutory consultees;
- through considering past, present and future land uses;
- by setting the 'time limit' and geographical boundaries for the EIA;
- by considering the requirement for additional data collection;
- by consciously considering the potential and then identifying indirect and cumulative impacts and impact interactions, and from this identifying those that are considered significant and warrant further assessment;
- by considering alternative options;
- by determining appropriate 'tools or methods to be used in the EIA;
- by addressing potential impacts in project design and the development of mitigation.

5. INFORMATION NEEDED TO ASSESS THE IMPACTS: THE PROPOSED PROJECT

5.1 *Background*

Before the assessment of environmental impacts can be carried out certain basic information about the project will need to be established. Some of this information will be of particular relevance in the consideration of indirect and cumulative impacts and interactions. This Chapter identifies the type and detail of information about the development proposals that should be obtained, where possible and practical, to enable the assessment to reflect the potential impacts more fully.

The key factors to be considered concerning a project are:

- the nature of the project;
- project phasing;
- the scale of the project;
- the site layout;
- emissions to land, air and water;
- ancillary development;
- proposed mitigation measures.

These are discussed in more detail below.

Chapter 6 is concerned with the information on the receiving environment that may be required for the assessment of indirect and cumulative impacts and impact interactions.

5.2 *Information Concerning the Project*

5.2.1 *The Nature of the Project*

It is essential to consider the nature of the project as this influences the type of impacts that are likely to occur. It is important to determine its key physical characteristics as these are important in influencing indirect and cumulative impacts and impact interactions.

For example, the impacts associated with a project to develop a new road differ greatly from the development of a power plant. The road, being a linear type of development, would have a different 'spatial', or geographical distribution of impacts when compared to the single location development of the power plant. Linear projects are more likely to sever environmental resources and therefore

interaction networks or diagrams (described in Chapter 3) may be particularly useful for assessing the impacts.

However, severance would not be such a key issue for all types of linear projects. Projects such as overhead cables would cause little on-the-ground severance when compared to constructing a road along the same route.

Information on the nature of the project should be obtained from the developer and operator. It would also be useful to consider the information gained from previous construction and operational experience as this may help in identifying some of the less obvious potential indirect and cumulative impacts and impact interactions. All this however, needs to be taken in the context of the receiving environment.

5.2.2 *Project Phasing*

The various phases of a project should be considered carefully and the activities likely to occur at each phase established when considering indirect and cumulative impacts and impact interactions.

For example the extraction of limestone, brings with it different characteristics particularly during the operational and restoration phases when compared to a road project where the construction phase may be of particular importance. Phasing can also influence the assessment of indirect and cumulative impacts and interactions in terms of when the activities are scheduled to occur. The case study prepared for Cardiff Waste Water Treatment Works (see Chapter 3) illustrates how phasing of development can result in different cumulative impacts.

When assessing impacts associated with potential future activities it should be noted that the prediction of impacts and their significance would be based on less reliable environmental information. Furthermore details of methodologies for certain activities, e.g. for decommissioning may be unclear. It is important that the assumptions on which the assessment has been based are made explicit in the Environmental Statement so that the decision maker is fully aware of the background to the assessment.

5.2.3 *Scale of the Project*

The scale of a project can also play an important part in influencing the type and distribution of impacts. This is already recognised within the basic framework of Annex II of the EIA Directive. This requires that projects within some of the categories should be of a certain scale and therefore likely to have significant impacts, before they become subject to a formal Environmental Assessment.

The influence of scale on the potential impacts from projects of a similar type can be illustrated by comparing two housing projects. For example, a relatively small scale housing project of 250 houses would have less impact than one with one for 1000 houses in the same location. Obviously the land take will be that much greater for the larger scale housing project. Other issues also have

to be considered such as the types and quantities of resources used, the generation of wastes, emissions and traffic. These factors can all influence the potential for indirect or cumulative impacts or impact interactions occurring and the significance of the impacts.

5.2.4 Site Layout

Layout of the development within a chosen site can also affect possible indirect and cumulative impacts and interactions, particularly when considered with other developments in the area. The location of an access road to a development which follows, in part, an already heavily used road may cumulatively result in unacceptable traffic congestion and noise. In another example the locating of a noisy operation close to other existing developments emitting noise may have an adverse cumulative impact on a nearby residential area.

5.2.5 Emissions to Air, Water and Land

Projects during their various phases will create emissions of some sort to air, water and land, whether this is air pollution, noise, discharge of cooling water, disposal of construction material etc. At the beginning of the assessment, the nature of emissions at each phase should be considered and where possible quantified. Consideration needs to be given to the likelihood of emissions interacting with other elements in the environment.

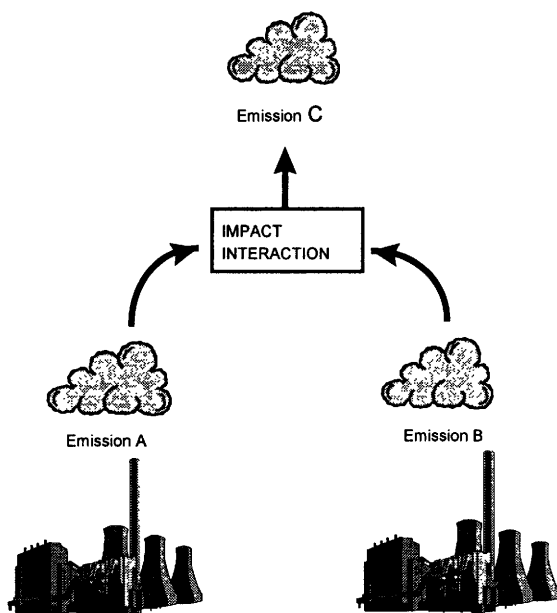

Figure 5.1 Impact Interactions , in the Form of Interaction between two Industrial Emissions.

There is also the cumulative aspect of emissions, not only from just one project, but also where emissions from a particular project could combine with those

from other developments and cumulatively have a significant adverse effect on a particular receptor.

Emissions from the proposed project need to be considered in the context of both the receiving environment and other existing or future development in the area. Information on emissions from other existing developments and developments likely to be built in the near future could be obtained from the regulatory authorities. This information would assist in identifying where possible interactions, cumulative or indirect impacts would occur. Development plans and consultation with the planning authority could also provide information on future development.

However, it should be noted that it is only practical to consider in the assessment future development which can reasonably be forecast. Further details on future development as part of the receiving environment is given in Chapter 6.

The IPPC Directive sets 'emission limit values', expressed in terms of specific parameters, concentration and/or level of emissions, which may not be exceeded during one or more periods of time. Emission limit values may also be laid down for certain groups, families or categories of substances.

The IPPC Directive requires the issue of permits for installations that fall under the legislation. Such permits are required to include emission limit values for pollutants likely to be emitted from the installation concerned in significant quantities, having regard to their nature and their potential to transfer pollution from one medium to another (land, water and air).

In all circumstances, the conditions of the permit shall contain provisions for the minimisation of long-distance or transboundary pollution and ensure a high level of protection of the environment as a whole.

5.2.6 Ancillary Development

Some projects bring with them their own related developments, often referred to as ancillary development. For example, a power station would also require the development of a sub-station and cables to carry the power that has been generated. These may be constructed and operated by a different developer and could be assessed as a separate project, but are inextricably linked to the original project. The cumulative impacts of the project and ancillary development could potentially be significant.

If however, the ancillary development is not included in the assessment the Environmental Statement may not identify such a degree of adverse impact. By not including the ancillary development the assessment would therefore not fully reflect the environmental impacts of the whole project.

Information on ancillary development associated with the project, which may be controlled by another developer, should be obtained where possible at the scoping stage. This information will enable potential indirect and cumulative impacts and impact interactions arising from that development to be considered as early as possible in the Environmental Assessment. If insufficient information is available to allow an assessment, this should be reported in the Environmental Statement to ensure that it is considered as part of the decision-making process.

Types of ancillary development that should be considered where possible in the Environmental Assessment include:

- access roads;
- pipelines for supply or removal (gas, water, sewers);
- power supply (overhead lines or buried cables);
- pumping stations;
- electricity sub-stations;
- quarries or borrow pits for the supply of materials;
- construction compounds;
- disposal sites.

5.2.7 Proposed Mitigation Measures

At the early stages of the assessment there will not be detailed information on the type and location of mitigation measures for a project. However, past experience or research should be able to give a good understanding of the measures that are likely to be implemented when considered together with the information on the project and receiving environment.

The assessor should be aware that some mitigation measures that would be implemented to reduce or avoid impacts can themselves cause their own impacts. These are often classified as indirect impacts or are sometimes referred to as 'impact shifts'. Noise barriers, for example, aimed at reducing the impacts of traffic noise on a residential area can also create a visual impact. The original impact of noise being shifted to become one that is now visual in nature.

It is important to consider mitigation measures early on in the assessment so that the best mitigation for a direct impact can be achieved without causing significant indirect impacts.

5.3 Summary of Items to Consider

In order to enable the potential indirect and cumulative impact and impact interactions to be identified and assessed, detailed information on the proposed development should be obtained wherever possible and practical to do so. This would assist in providing a complete picture of the environmental impacts associated with the development.

A checklist would be a useful tool in ensuring that the following items have been considered when undertaking the EIA for indirect cumulative impacts, as well as impact interactions:

- what key activities are associated with each phase of the project?
- what is the scale of the project?
- what is the proposed layout of the development?
- are there emissions to air, water or land?
- when will the emissions occur?
- what existing emissions are there that may interact in some way (including cumulatively) with the proposed emissions?
- what ancillary development is there associated with the project?
- what are the likely mitigation measures?

6. INFORMATION NEEDED FOR THE ASSESSMENT: THE RECEIVING ENVIRONMENT

6.1 Background

Baseline information on the receiving environment is of key importance to allow evaluation of indirect and cumulative impacts and impact interactions to take place. Particular attention needs to be given to defining the baseline conditions of the affected environment. These baseline conditions then provide the context for evaluating the environmental impacts of a project, and therefore indirect and cumulative impacts, as well as impact interactions.

The requirement for baseline information should be considered in terms of the need to assess indirect and cumulative impacts and impact interactions. For example, by identifying where there are relationships between certain features of the environment which can act as interaction pathways and therefore can result in indirect impacts. Network and systems analysis can be a useful way of identifying where indirect impacts are likely to occur (see Chapter 3 for more details).

Data collection to establish the baseline conditions for the assessment is of key importance as this data will be used to evaluate the significance of the impacts resulting from the project. Throughout the Environmental Impact Assessment process the requirement for data will need to be continuously reviewed.

6.2 Defining the Boundaries of the Assessment and Baseline Conditions

6.2.1 Setting the Boundaries - the Need for Review

Setting the geographical and time boundaries have been discussed in the Scoping Chapter (Chapter 4) of these Guidelines. Determining the baseline conditions and defining the study area are both inter-linked. For practical reasons a preliminary study area should be defined at the early stages. However, this must be subject to modifications according to the nature of the baseline conditions and consideration of indirect and cumulative impacts and impact interactions. For example, if only the direct impacts were assessed without interaction pathways being considered, the study area may well be smaller.

It is important that information is gathered wherever possible to enable an informed picture to be built up of the nature of the receiving environment. A certain amount of information should be gathered at the scoping stage to allow the key environmental impacts to be identified, including those indirect, cumulative or interactive in nature. However, following Scoping it is likely that there will be a requirement for collection of additional data to complete the Environmental Impact Assessment.

6.2.2 *Trans-Boundary Impacts*

Some indirect and cumulative impacts and impact interactions have the potential to cross administrative boundaries. These could be international boundaries or boundaries between local authorities within a country. This can be especially relevant in cases where pollutants are dispersed in either air or water media over relatively large geographical areas. For example, the cumulative effect of acid rain as an indirect impact of emissions from other countries has been identified as a major contributory factor in the decline of pine forest in Scandinavia.

Socio-economic impacts may also cross administrative boundaries. For example, infrastructure development (such as tunnels or bridges) which links different administrative areas may have a profound and sudden indirect or cumulative impact on traffic patterns and other socio-economic factors on a wide scale.

Project scoping and especially the selection of an appropriate geographical boundary and therefore the area for the collection of baseline data, should where possible take into consideration this potential for trans-boundary impacts. Using natural boundaries, such as watersheds, is often a more appropriate approach to impacts affecting natural ecosystems than using the local political or administrative areas. The project consultation process should be designed in a co-operative way, so that expert opinion is included from as wide a range as necessary, irrespective of boundaries.

Trans-boundary impacts are relevant to the assessment of indirect and cumulative impacts as well as impact interactions. In carrying out an assessment at the project level it must be recognised that it may not be possible to assess trans-boundary impacts in detail. However, where possible, trans-boundary impacts should be identified and quantified so that this will at least be taken into account during the decision-making process.

6.3 *Collecting Data*

6.3.1 *Determining Data Requirements*

Data collection is required to allow an assessment of all impacts of the project. In terms of data collection, the key issue for the scoping exercise is to focus the Environmental Impact Assessment (and therefore additional data collection) on the sensitive receptors, or environmental parameters. The important factor is therefore to identify the data requirements to enable the assessment of the direct impacts as well as indirect and cumulative impacts, and impact interactions. The database required to assess indirect and cumulative impacts and impact interactions is likely to be extended in comparison to the information collected for direct impacts, in terms of the geographical and time boundaries as explained in Chapter 4.

As part of the Scoping exercise as much baseline data as possible will be collected. However, following this initial data collection exercise, it is likely that additional data will be required for the Environmental Impact Assessment.

Obtaining additional data may sometimes be seen as expensive and a cause of delays to the project programme. The important factor will therefore be to ensure that data requirements are identified systematically and early on in the assessment process. The availability and quality of existing data should be assessed in the scoping stage.

In deciding the requirement for baseline data the practitioner will need to consider how the data will be used to assess indirect and cumulative impacts, as well as impact interactions, before the collection process begins. This will include consideration of the type of data and the level of detail required for the assessment. For example, a detailed ecological survey may be appropriate to assess the direct impacts on the proposed development site. However to assess indirect or cumulative impacts or impact interactions it may be more appropriate to collect data on designated sites of ecological interest within the surrounding area or 'geographical boundary'.

6.3.2 Data Sources

Through the collection of baseline data the status of resources and sensitive receptors or impact factors can be established. As previously mentioned in Chapter 4, which is concerned with Scoping, baseline data can be obtained in a number of ways and from a number of sources:

- consultation with statutory and non-statutory authorities;
- review of development plans and resource management plans;
- regulatory standards;
- surveys and sampling;
- existing databases; and
- local businesses and communities.

Surveys and sampling may be required where there is no available data or the existing data is out of date. The area that is surveyed should be defined taking into consideration the potential for indirect and cumulative impacts and impact interactions to take place. Data which is gathered on the local community and businesses can also assist in identifying these impact types and can provide valuable information for assessing the socio-economic impacts of a development. Questionnaires and public meetings are two of the methods that have been used in practice in Finland for such purposes (for further details refer to Chapter 3).

The information collected from the above sources is required to determine the existing status of the environmental resource, current trends, existing regulatory requirements and development plans and programmes.

6.3.3 *Using Indices*

As with the assessment of direct impacts, the availability of baseline data for indirect and cumulative impacts and impact interactions will inevitably vary. It may therefore be appropriate to use accepted indices (for example biological indicators or water quality parameters) for baseline data. Indicators are often used in assessing direct impacts. However, the indicator may need to be different to assess indirect or cumulative impacts, or impact interactions. For example, local impacts on a river near a construction site can be assessed using an environmental parameter such as dissolved oxygen. A number of parameters may however be more appropriate to assess indirect or cumulative impacts some distance downstream.

6.3.4 *Identifying Sensitive Receptors*

Sensitive environmental parameters, 'receptors' or resources may be identified by means of designation under statute by the relevant authorities, for example, a Special Protection Area or Scheduled Ancient Monument. Alternatively they may be a sensitive area which falls within certain categories, for example, an aquifer for potable water, noise sensitive area or air quality action zone. Particular consideration needs to be given to the sensitive receptors as they could be affected by direct impacts from a project only to a slight degree. However, the impact of an indirect impact, cumulative impact or impact interaction may be significant.

In addition, a resource which may be designated for its ecological interest may also be important for economic and cultural reasons. Therefore an impact on that resource could cumulatively have a significant adverse impact on the local community.

6.3.5 *'Carrying Capacity', Resource Thresholds and Stress Factors*

The important factor will be to establish how environmental resources will respond to impacts and therefore to establish their 'carrying capacity'. There is often a limiting factor in the threshold of a particular resource. The 'threshold', or 'carrying capacity' can be defined as the level at which the resource can no longer function adequately or as before, beyond which the resource can not be sustained.

The additional impact or 'stress' imposed on the resource therefore needs to be considered for each environmental parameter. This will need to take into consideration the existing impacts as well as the proposed activities. This can be important when assessing the cumulative impacts of a number of developments in an area. To establish environmental resources affected and existing stress levels it will be necessary to identify key activities and possible future activities that are likely to occur.

Indicator species are often used to assist in determining existing stress levels and the threshold of a resource. However, if use of indices is not appropriate, a more general assessment may be useful. The objective is to identify at what point indirect or cumulative impacts, or impact interactions would result in a

significant impact. By determining the carrying capacity of a resource, determining the significance of indirect and cumulative impacts as well as impact interactions can be assisted.

Information on the carrying capacity and limiting factors should be obtained through consultation with authorities or agencies, particularly those responsible for regulating emissions, and from data contained within area wide plans.

6.3.6 Trends

Current trends within the environment also play a part, particularly when considering what the situation in the future may be in relation to baseline conditions. It will be important to investigate how the environment has been affected in the past and, if possible, to identify any trends that are occurring and why. This will help to establish the baseline conditions and also possibly identify other actions that may result in indirect or cumulative impacts, or impact interactions. For example, there may a trend of continual improvement in the water quality of a river and the Environmental Impact Assessment should therefore take into account, wherever possible, the likelihood that the future water quality will be an improvement on the existing situation. This is closely linked with the section below which is concerned with other actions that may affect the environment and which should be taken into consideration when assessing indirect and cumulative impacts and impact interactions.

Trends analysis will take into consideration the historical context as significant impacts may result from cumulative impacts over time. This historical information will help to define the baseline more accurately. The historical information will also help to evaluate any indirect and cumulative impacts as well as impact interactions according to how the resource has responded in the past, and therefore in determining the resource threshold.

6.3.7 Regulatory Standards

Regulatory standards can be useful in establishing baseline conditions. In some cases they can determine the level of emissions permitted if they apply to existing or proposed developments. Regulatory standards, which are often concerned with emissions such as noise or pollutants to air or water, may not be the actual existing baseline for the area. However, it will be important to consider such standards in the assessment of indirect and cumulative impacts and interactions as they influence development activity and can often affect the way in which a project can operate.

The case study of Killingholme power station (Appendix I) shows how the standard for noise levels generated in the area, imposed by the local environmental health department, played a part in the assessment of the cumulative impacts of the proposed new development. Noise from the new development had to be considered together with the existing power station present in the same area.

6.4 *The Influence of Other Activities*

Considering other actions which can affect the environment can also assist in defining the condition of the receiving environment and the development pressures on the environment. Both cumulative impacts and interactions can occur as a result of other development in the locality of the project, whether it be existing development or development planned for the future. The case study on Cardiff Waste Water Treatment Works, presented in Appendix B, illustrates the assessment of the cumulative effects from planned future development adjacent to the project. This is an example of the assessment of different types of development on particular receptors. Cumulative impacts can also arise as a result of existing development or activities in a particular area with similar environmental effects, such as those illustrated by the Killingholme Power Station case study (see Appendix I).

Data on other activities which may result in indirect and cumulative impacts and interactions can be obtained from planning authorities, regulatory authorities and from the review of development and resource management plans. Although, as stated before, the assessment can only be based on the available information, and in the case of development in the future, that which can reasonably be presumed to go ahead. Another issue to be considered is that the proximity of development (past, present or planned) to a particular project does not always provide the criteria for inclusion in the assessment. What should be borne in mind is whether the other development affects the resources which would be affected by the project. If this is not the case it will not be necessary to include it in the assessment.

Other development or activities which benefit the environment should also be taken into consideration in the assessment of indirect and cumulative impacts and impact interactions. This will again influence the future baseline conditions of the area. The overall net effect of all activities on the environment should be used in the assessment.

By establishing this information, the limits of the study area can be refined to take into account, where possible and practical, the influences of other development. It should, however, be remembered that the purpose of defining boundaries (both geographical and time) is to assist in rationalising the assessment. Nonetheless some impacts may not in reality always conform to the assumed boundaries of the study area.

6.5 *Summary of Items to Consider*

Defining the baseline conditions of the receiving environment provides the context for evaluating the environmental impacts of a project. Given below is a brief outline of the steps that should be taken to enable potential indirect and cumulative impacts and impact interactions to be assessed as part of the project.

- identify early on the availability and quality of baseline data;

- identify the requirement for additional baseline data - consider how the data will be used to assess indirect and cumulative impacts, as well as impact interactions and the type of data and level of data required;
- focus additional data collection on sensitive receptors;
- ensure that the data collection exercise is extended to the geographical and time boundaries set to assess indirect and cumulative impacts, as well as impact interactions;
- focus data collection on determining the current and future status of the environmental resource, historical trends, existing regulatory standards and development plans and programmes;
- consider the use of indices if appropriate - different indices may be appropriate to assess direct impacts compared to indirect and cumulative impacts, as well as impact interactions;
- determine the carrying capacity or resource threshold - this can help in assessing the significance of indirect and cumulative impacts, as well as impact interactions;
- establish trends to define the baseline condition more accurately to assist in determining the resource threshold;
- consider the importance of Regulatory Standards;
- identify and consider impacts from other activities in the area.

7. ASSESSING THE IMPACTS - AN OVERVIEW

7.1 Introduction

Details of the methods available for the assessment of indirect and cumulative impacts and impact interactions, and how they can be incorporated into the project assessment have been given in Chapter 3. Chapter 3 has also shown that there are a number of key stages in assessing these impacts at the project level:

- identifying where indirect and cumulative impacts and interactions will potentially occur;
- identifying the cause and effect relationship – the pathway that impacts will follow which will show how project activities will impact on the existing environment;
- determining the response of the resource to a change in the environment, including assessing the magnitude and the significance of the impacts;
- developing mitigation measures to address the impacts; and
- developing monitoring programmes to gauge the indirect and cumulative impacts, and impact interactions, and establishing mechanisms for addressing significant impacts if identified.

7.2 Scoping – An Ongoing Process of Review

The importance of Scoping in identifying the potential and likely significance of indirect and cumulative impacts and impact interactions has already been addressed within the Guidelines (see Chapter 4). However, Scoping is an iterative process. As the project develops from feasibility to outline detailed design and development of mitigation measures, the potential for indirect and cumulative impacts and impact interactions needs to be constantly reviewed and re-examined. This is because further indirect and cumulative impacts and impact interactions may become apparent during the project planning. For example, mitigation measures designed to address direct impacts may result in indirect impacts (or 'impact shifts').

7.3 Magnitude and Significance of the Impact

7.3.1 Introduction

Once the impacts have been identified the next step will be to ascertain the magnitude of the impact and its significance (see sections 7.3.2 to 7.3.4 for further details). Establishing significance criteria for indirect and cumulative impacts, as well as impact interactions may be more complex than for direct impacts as broader issues can be expected to apply.

The indirect or cumulative impact or impact interaction should be quantified, if possible and practical to do so. An example would be the percentage of habitat lost or increase in a particular pollutant.

Where it is not possible to undertake a detailed quantitative assessment, a qualitative assessment can be carried out. In the case of a qualitative assessment, the magnitude of the impact can be ranked, e.g. high, medium or low, according to set criteria.

Other factors to take into consideration when assessing the magnitude of these impact types are:

- what changes would occur anyway in the environment if the project did not go ahead?
- how have past actions contributed to the current baseline condition?

When determining the significance of an impact, as well as taking into account the magnitude, consideration needs to be given to:

- the duration, i.e. will the impact be temporary or permanent;
- the extent, e.g. the percentage of a habitat that may be lost;
- the frequency of the impact;
- the 'value' and resilience of the receptor affected; and
- the likely success of mitigation.

Thresholds used to determine significance will vary depending on the environmental parameter and its importance. The criteria used in the assessment should be clearly stated.

7.3.2 Modelling

Modelling is an analytical tool which enables the quantification of cause and effect relationships by simulating environmental conditions. The most common form of modelling is computer based and predicts the chemical and physical impacts of a particular action on the environment.

Mathematical modelling lends itself to the spatial and time frame analysis of environmental elements such as air quality, water quality, noise levels, and dispersion and deposition of emissions. Providing there is suitable baseline information the cumulative impacts from more than one project can often be assessed using modelling.

Photomontages can be considered as another form of modelling. In this case it is the modelling of the visual impact of, say, a number of developments in the same geographic area. Due to the nature of the landscape, the assessment can only be qualitative.

7.3.3 Matrices

Matrices can be used to show the interactions between impacts and their significance through the use of a ranking system. They cannot however, be used in themselves to quantify the actual significance of the impacts, which can only be done by using other methods. Weighting of matrices to reflect factors such as duration, frequency and extent can be used to 'score' or rank impacts, however the criteria used should be clearly set out.

7.3.4 Carrying Capacity and Threshold Analysis

This approach considers the capacity of a resource and its resilience to environmental change. This can be particularly useful when assessing the cumulative impact of a number of actions or developments on one resource, if it is possible to ascertain the threshold or limiting factor.

Thresholds are also set by regulatory authorities for levels of emissions. These too can be used in assessing the magnitude and significance of an impact.

7.4 Mitigation

Mitigation and its relationship to indirect and cumulative impacts and impact interactions can be considered in two ways. These are:

- mitigation of these impact types; and
- indirect or cumulative impacts or impact interactions that are caused by mitigation measures (also known as an 'impact shifts').

Impacts caused by mitigation measures themselves have been previously mentioned (Chapter 5). The scope for actual mitigation is an important factor to be considered.

For example, mitigation of an indirect impact needs to examine the cause and effect pathway and identify where it is best to implement the measures to avoid, reduce or remedy the impact. It may be more appropriate to put measures in place at the 'cause' end of the impact or at the receptor end.

When considering mitigation measures to address cumulative impacts from a number of projects there may be a need for co-operation between developers. For example, funding for the mitigation measures may need to come from a number of sources.

It must also be recognised that mitigating indirect and cumulative impacts as well as impact interactions may be different from mitigating direct impacts. Detailed guidance can not be given as mitigation will have to be considered on a project by project basis.

7.5 Monitoring

The assessment of indirect and cumulative impacts and impact interactions is an iterative process in which the potential for such impacts is re-examined through all stages of the project.

Monitoring of impacts is the last step and once a project has commenced, provides an opportunity to check the accuracy of the predictions and ensure that the mitigation measures implemented are effective. There are inherent uncertainties associated with assessing impacts which are not a direct result of the project and may also be linked to other projects or activities.

When undertaking any monitoring of impacts there should be indicators against which the magnitude and significance can be gauged. Furthermore there needs to be an appropriate time-frame for the monitoring programme, particularly as some impacts are not immediately apparent. The geographical scale of the monitoring should also be appropriate to the nature of the impact and resource being monitored.

When monitoring mitigation measures there should be a measure of the efficiency in avoiding, reducing or remedying the impacts. Where necessary this should highlight problem areas and ways in which the measures can be made more effective.

7.6 Problems and Uncertainties

As with environmental assessment in general, there are often uncertainties and problems when assessing indirect and cumulative impacts and impact interactions. This can be due to a number of factors.

7.6.1 Boundaries

When identifying a geographic boundary which is suitable for the assessment there is always the issue of where the cut-off point is for areas to be included. The boundary should be practical given the resources and data available for the assessment. The time-scale which is to be considered for the past and reasonably foreseeable impacts is often limited by a shortage of data. Furthermore there is an inherent uncertainty associated with activities outside the control of the project being assessed. Boundaries should be treated as useful tools in rationalising the scope of the assessment but they should also be flexible if possible.

7.6.2 Baseline Conditions

There can also be problems associated with data when establishing baseline conditions for the assessment. Suitable data may not exist or be unavailable, the data may be incomplete or at an inappropriate scale. Obtaining information on activities from the past, present and future can be difficult.

Obtaining baseline information where there are trans-boundary impacts, whether local, regional or national, can also prove to be problematic. Some

authorities will have suitable data available others will not. Furthermore different thresholds may be set for particular levels of emissions or impacts on resources.

7.6.3 *Understanding Interactions and Pathways*

Where there are interactions and pathways it is important that the system response is understood. This understanding will enable the assessment to reflect as accurately as possible the impacts that will arise as a result of a particular action. Complex interactions will give rise to non-linear responses which are not always clearly understood and therefore will be difficult to assess.

7.6.4 *Assumptions*

Any assumptions used in the assessment should also be well documented so that the decision maker is fully aware of the basis on which the assessment was made.

7.7 **Reporting**

The results of the assessment of the indirect and cumulative impacts and impact interactions need to be reported in the Environmental Statement. There are two key approaches for reporting these impacts:

- integrating the assessment into each topic section; or
- producing a separate chapter

7.7.1 *Use of Tables*

In addition to the above, it may also be useful to have a summary, setting out the overall impacts which should be considered cumulatively for individual receptors. This could be presented in tabular format which focuses on the receptor, as shown in the extract from the Environmental Statement prepared for the Strathclyde Crossrail project (see Chapter 3). By presenting the information in such a manner it clearly shows where receptors will experience more than one type of impact. This is a useful tool to convey the overall impacts to the decision makers and public.

7.7.2 *Use of Schematic Diagrams*

Information may also be reported as a schematic diagram as shown in Figure 7.1 below.

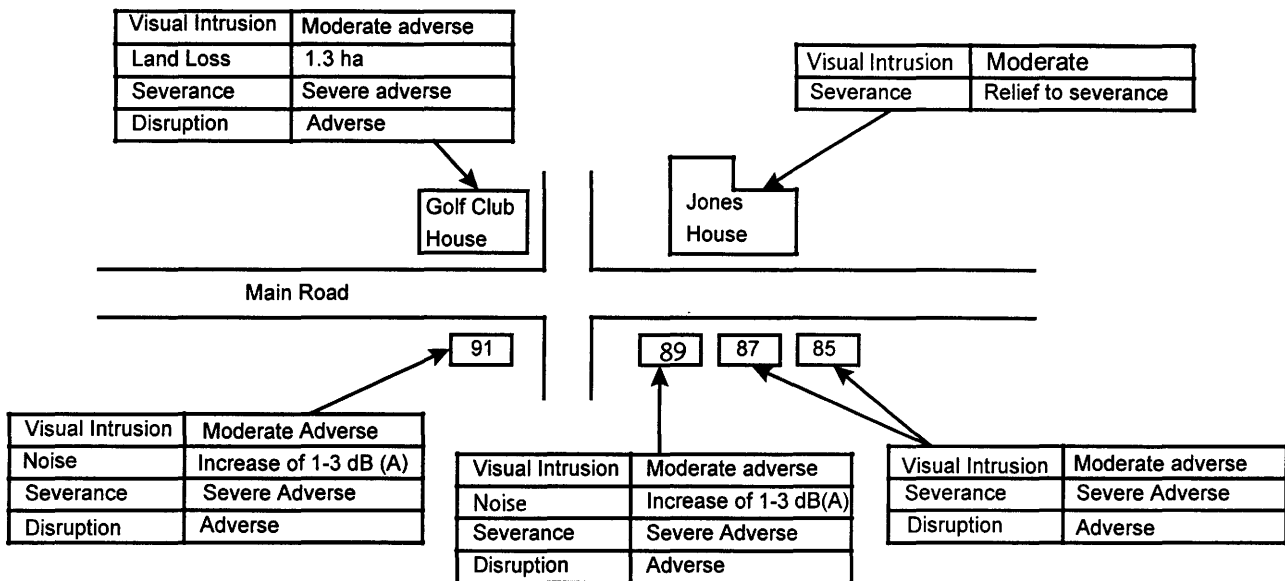

Figure 7.1 A Schematic Diagram

7.7.3 Other Methods

Other methods of reporting indirect and cumulative impacts, as well as impact interactions are matrices (using quantitative or qualitative information or indices), figures and maps. Examples are again included in Chapter 3. Whichever ‘tool’ is used to report the assessment, it is important that the Environmental Statement reports the assumptions that were made. It is also useful to describe the process of the analysis and interpret the results.

7.7.4 Avoidance of Double Counting

Indirect and cumulative impacts and impact interactions can often affect more than one environmental element or receptor, which could lead to such impacts being assessed more than once, therefore being double counted. This can lead to uncertainty about the actual significance of the impact. A summary table can help overcome this by providing a list of all the impacts identified. This would highlight any impacts that have been double counted.

7.8 Summary

There are a variety of methods associated with identifying and assessing indirect and cumulative impacts and impact interactions, some of which will be more suitable for one particular project than another.

In practice, the individual methods outlined in Chapter 3 have been found to be used in combination with other methods. This is because there are those which identify how and where such impacts will occur and those which evaluate the impacts.

The key factors when selecting the tools or methods to be used for a project are:

- what are the resources available for the assessment?
- what is the nature of the impact?
- is the 'tool' appropriate for the project? Should a combination of 'tools' be used at different points in the project?
- is suitable data available for particular methods?
- will it provide a meaningful evaluation and present the results in a clear manner?

Attention should also be paid to how the indirect and cumulative impacts and impact interactions should be presented in the Environmental Statement. Showing the overall impacts in a table or as a schematic diagram could enable them to be more easily understood by the decision maker and public.

APPENDIX 1 - METHODOLOGY

APPENDIX 1 - METHODOLOGY

The study leading up to the production of the Guidelines comprised three main stages:

Stage 1. Review of Legislation and Literature

An investigation was undertaken into the EIA legislation currently in use throughout the Member States of the European Union (EU). The legislative review focused on the legal requirements for the assessment of indirect and cumulative effects of a project as well as the interactions and how the relevant requirements of the EC Directive (85/337/EEC) have been translated into national law. The study also included an extensive literature review of existing procedures, guidance, techniques and research findings.

Stage 2. Review of Current Practices

To investigate current practice within the EU of the assessment of indirect and cumulative effects of a project as well as the interactions, the study included a review of a total of 60 Environmental Statements, 12 from each partner country (Germany, Finland, Greece, Portugal, UK). For each country this included Environmental Statements for 4 projects from Annex I of the EIA Directive and 8 projects from Annex II.

A review of each Environmental Statement was undertaken which focused on the assessment of indirect and cumulative effects, as well as the interactions. Questionnaires were also sent to the authors. Following this, more detailed discussions were held with a selected number of authors to obtain additional information on the approaches used for identifying and assessing these impacts.

The analysis of the case studies found that only a small number of those reviewed assessed cumulative impacts, indirect impacts or impact interactions in a comprehensive, scheme-wide manner. However, in many cases there was an assessment to some extent of indirect and cumulative impacts as well as impact interactions, although often the assessment was not comprehensive.

The conclusions drawn from the case study analysis was that there was not a consistent approach to the assessment of indirect and cumulative impacts and impact interactions. This could be attributed to a number of factors. These include a lack of practical comprehensive methods and techniques which can be applied to projects that do not require significant additional resourcing or costs. In addition there appears to be a general lack of information and training on how to approach such issues. In some Member States the relevant requirements of the EIA Directive have not yet been translated into national legislation. In addition, the research found that a lack of sufficient baseline data to meaningfully undertake such assessments was also a contributing factor.

Stage 3. Development of the Guidelines

The Guidelines have been developed based on the findings of the literature review and the detailed investigation of the case studies. The Guidelines are therefore founded on, but not entirely limited to, the European experience of EIA in practice.

APPENDIX 2 - CASE STUDIES

A. Nestos River Project, West Thrace, Greece	A2-1
B. Cardiff Waste Water Treatment Works and Outfall, UK	A2-5
C. Highway E18: Lohja - Salo, Finland	A2-10
D. Central Sewage Treatment Plant, Turku, Finland	A2-14
E. Strathclyde Crossrail, Glasgow, UK	A2-18
F. Regina to Stromona section of the Egnatia Motorway, Greece	A2-26
G. Securing the Keil Canal (Section Rendsburg East), Germany	A2-29
H. B452 Reichensachsen Bypass, Germany	A2-35
I. Killingholme Power Station Extension, UK.	A2-39
J. Rethimno City Waste Water Treatment Works, Crete, Greece	A2-44

CASE STUDY A - NESTOS RIVER PROJECT, WEST THRACE, GREECE

Methods Used: Trends Analysis, Expert Opinion

Background to the Project

The Environmental Statement assessed the environmental impact of construction and operation of three dams on the Nestos River. The study area extended from the Bulgarian borders to the delta estuary and was based upon the hydrological basin of the Nestos river.

The proposed dams would be used to produce hydro electric power and to control river flows and irrigation. Water transport would operate during the night time period.

The delta of the Nestos River is a Ramsar site and characterised by sensitive forest and wetland ecosystems. The area is also valued for its landscape interest.

At the time of the Environmental Statement, the first dam had already been constructed.

Overview of the Methodology

The Environmental Assessment was undertaken by a team of specialists and co-ordinated by a project manager.

A Scoping Report was not produced for the project. However, the Ministry required that the Environmental Statement consider the cumulative impacts of the three dams and the indirect impact of the development downstream of the dams. The Environmental Statement therefore considered impacts in a wider area surrounding the dams and the designated delta area.

Potential indirect and cumulative impacts were identified and discussed by the project team and project co-ordinator during team meetings where the views of specialists could be exchanged. The magnitude of these impacts was also assessed. This information was presented in an impact table. Indirect and cumulative impacts were considered as an integral part of the assessment of impacts for each topic (e.g. land use).

The Environmental Statement included a separate chapter for each topic (sensitive receptor) which describe the existing environment and assessed the of impacts (including indirect and cumulative impacts). Although not produced in the Environmental Statement, the following table has been compiled to show, in a summarised form, the type of impacts that were identified and how they were addressed within the Environmental Statement.

Table 1 Types of Potential Indirect and Cumulative Impacts Identified

Impact	Comment
Impact on bird populations of the delta area (designated Ramsar site)	Ministry required Environmental Assessment of wider area to consider the downstream impacts of the dams on the delta, and therefore indirectly on the bird populations.
Impacts from ancillary development associated with construction and operation of the three dams	<p>The Environmental Statement addressed impacts from excavation of quarry material for construction of the dams - this included assessment of disposing of the unsuitable overburden material.</p> <p>Environmental assessment of the ancillary developments included construction of access roads to allow construction of the dams and new bridges to provide access to areas affected by flooding of the reservoirs.</p>

Detailed examples of indirect and cumulative impacts identified within the Nestos River study area are outlined below:

Example 1 - Impact on Delta Area

Collection of Baseline Data

The Environmental Assessment utilised information available from the environmental work undertaken for the first dam (constructed in 1983). However, this information mainly related to planning and socio-economic issues. The Environmental Assessment also utilised environmental data collated previously for the other two proposed dams.

A significant amount of data was available to the project team on the delta area as a result of the Ramsar designation. Where possible the project also utilised data from consultants with existing knowledge and previous experience of working in the area.

During collection of the baseline data the project co-ordinator identified that current land use practices were impacting upon the delta system. For example, it was identified that the current practice of pumping groundwater for irrigation was resulting in sea water intrusion. As part of the assessment the project team therefore concluded that there was a need to assess and predict environmental impacts that would occur without the proposed project in order to establish accurate baseline conditions and environmental trends. The Environmental Assessment therefore used the method of trends analysis.

The study area selected for collation of baseline data was determined separately for each of the environmental parameters assessed, based on expert opinion. For example, land use data was obtained from aerial photographs for a corridor along the Nestos River which extended downstream from the proposed dams. The study area was extended at the delta to cover a wider area of interest beyond the designated Ramsar site.

Assessment and Reporting of Impacts

The identification and assessment of indirect and cumulative impacts was based on expert opinion of the specialist members of the project team. The assessment also used the existing baseline data and information available on impacts that had resulted from current practices. This related primarily to the impact on flora and fauna of the delta.

The assessment took into consideration current trends and practices to identify cumulative and indirect impacts. For example, the assessment considered the cumulative impacts associated with embankments that had been constructed close to the estuary and the influence that these were having on the flooding regime of the delta.

The cumulative and indirect impacts were reported as an integral part of the assessment for each environmental parameter.

Example 2 :Indirect Impacts of Ancillary Developments

Collection of Baseline Data

The Environmental Statement took into consideration impacts resulting from ancillary activities associated with the scheme. The need to assess such impacts was therefore considered during data collection.

Assessment and Reporting of Impacts

The project team and project co-ordinator identified a number of ancillary activities that would result in indirect impacts as a result of the proposed dam constructions. These included the provision of access roads to the dam sites to allow their construction, construction of road bridges and roads to maintain access to areas which would be isolated by flooding of the reservoirs, quarrying activities for construction materials for the dams and disposal of the unsuitable overburden excavated to allow quarrying of the stone for the dams.

The impacts of these ancillary or secondary elements of the project were reported as an integral part of the assessment of the impacts on each environmental parameter.

Evaluation of the Methodologies Used and Implications to the Project

The identification and assessment of impacts was based on the experience of the project co-ordinator and the specialists appointed to the project team. This approach was facilitated by close interaction between members of the project team. This allowed exchange of ideas and enabled the project co-ordinator an overall perspective of the indirect and cumulative impacts and their significance to the project.

Establishing the environmental trends resulting from the current management of the delta was considered a fundamental part of the Environmental Assessment.

Although a short timescale was imposed on the project team to complete the Environmental Assessment, the project co-ordinator considered that it was satisfactorily completed within the timescale. The project co-ordinator considered the implications to resourcing and programming the project were not significant as the requirement to assess indirect and cumulative impacts had been identified and allowed for at the start of the project.

Although assessment of the cumulative impacts required additional baseline data, this was available as a result of the previous studies undertaken for the Ramsar site and the previous environmental work for the dams.

CASE STUDY B - CARDIFF WASTE WATER TREATMENT WORKS, UNITED KINGDOM

Method Used: Consultations

Background to the Project

The Environmental Statement was prepared to assess the effect of constructing a new Waste Water Treatment Works (WWTW) and outfall. The WWTW would occupy an area of approximately 20 hectares which is currently derelict, previously having been used for the disposal of slag from a former steel works. The site lies on the outskirts of the City of Cardiff and is surrounded by mainly heavy industrial uses, with residential properties and other mixed land uses beyond. Adjacent to the site is the Severn Estuary, designated as a Ramsar Site, Special Protection Area (SPA), and at the time, under submission for a Special Area of Conservation (SAC).

Overview of the Methodology

The Environmental Statement for the WWTW identified a number of potential indirect and cumulative effects.

The method adopted was based on the identification of the key impacts primarily from an extensive consultation process during the scoping stage. On a number of occasions joint scoping meetings were held with the statutory bodies which included relevant departments of the local planning authority (Development Control and Environmental Health), the Environment Agency (water environment), Countryside Council for Wales (nature conservation and landscape) and Cardiff Bay Development Corporation (responsible for promoting development and regeneration of Cardiff Bay). The initial scoping meetings focused on identifying sources of baseline data, potential impacts (including cumulative and indirect impacts) and mitigation proposals. The scoping meetings also established links to facilitate exchange of information as the project progressed. Joint meetings were held with the statutory bodies following scoping to allow exchange of information and ideas.

During the Environmental Impact Assessment the extensive consultation exercise was used to collect baseline data from both statutory and non statutory bodies, taking into consideration the possible indirect and cumulative impacts identified from the Scoping stage. As consultations were ongoing, further sources of data were identified and information collected using an ongoing review process. Areas of deficiency in data were identified and where required further baseline surveys were undertaken.

Further impacts were however identified as more detailed design information on the project became available and as a result of data gathering, ongoing

consultation and co-ordination and review of the various impacts and their relationships throughout all stages of the assessment process.

The cumulative and indirect impacts were assessed using the same approach and significance criteria developed and adopted for the direct impacts. The impacts were identified within a number of different chapters of the Environmental Statement and discussed and incorporated within the overall assessment of the effect on each receptor (e.g. ecology, traffic etc.).

Although not produced in the Environmental Statement, the following table has been compiled to show in a summarised form the type of cumulative impacts that were identified and how they were addressed within the Environmental Statement.

Table 1 Types of Potential Cumulative and Indirect Impacts Identified

Impact	Comment
Development of the WWTW together with an adjacent new Peripheral Distributor Road (PDR)	Assessment of potential impacts for selected sensitive receptors and for different construction scenarios. Potential environmental impacts identified at the initial consultation stage and addressed in the ES.
Combined impacts of construction of the WWTW, peripheral road, Cardiff Bay Barrage and relocation of a heliport on overwintering birds	Identified as an issue at the initial consultation and scoping stage and considered by consultees as a strategic issue. Strategic Environmental Assessment considered to be outside the scope of the regulations for the WWTW development. ES therefore only addressed how other projects could result in changes and importance in feeding areas for overwintering birds.
Associated sewerage network to transfer flows to the new WWTW	Identified the potential for impacts and the need for Environmental Assessment. Impacts were not identified and assessed within the ES and could therefore not be considered during the decision making process.
Disposal of spoil from construction on a nearby site	Not considered as a significant issue in ES. Due to changes in the design this became a significant issue following publication of the ES. A separate ES was prepared to assess the impacts of spoil disposal. These impacts were therefore not considered as part of the decision making process for the WWTW.
Loss of mudflats from construction of the outfall	Addressed in the ES as resulting impact on macroinvertebrate communities which are food sources for overwintering birds.
Construction of sea defences for the WWTW	Addressed in the ES as resulting impact on erosion and accretion of mudflats which are feeding areas for overwintering birds.

Detailed examples of indirect and cumulative impacts identified within the Cardiff WWTW study area are identified below:

Example 1: Cumulative Impact - Construction of the WWTW and a Peripheral Distributor Road adjacent to the site

Collection of Baseline Data

Planning permission had been granted for a new peripheral distributor road, a short section of which would form the southern boundary of the WWTW. The road would therefore lie between the proposed WWTW and the Severn Estuary. No decision however, had been made on the timescale for construction due to lack of funding.

In early scoping meetings, information was requested on planned future development in the vicinity of the WWTW. Statutory consultees advised on the proposals to develop the road and commented on the scope of the Environmental Statement for the WWTW. They indicated that the ES should take into consideration and assess the cumulative environmental impacts associated with the development of the WWTW and the new road during both the construction and operation phases.

Information was obtained from the relevant statutory bodies on the road proposals. This information included detailed engineering information and drawings for the Environmental Statement and details of mitigation measures (including landscaping proposals adjacent to the WWTW site).

Assessment and Reporting of Impacts

Although not documented, a judgement appears to have been made that the cumulative impacts of the two schemes relate to only some of the sensitive receptors within the receiving environment. These were ecology (in relation to disturbance to the overwintering bird population of the adjacent Severn Estuary); traffic (in relation to cumulative impacts on traffic mainly during the construction phases); and visual impacts (in relation to the impact on the landscape character of the area in general and to account for views of the WWTW from the proposed new road and landscaping proposals).

In the absence of information on the likely construction programme, the assessment addressed the following possible scenarios:

- Construction of the WWTW road prior to construction of the road
- Construction of the WWTW and road simultaneously
- Construction of the WWTW after construction of the road

The assessment of the cumulative impacts of the two developments was reported within a sub section of each of the three relevant chapters of the Environmental Statement.

Example 2:

Cumulative Impact - Construction of the Cardiff Bay Barrage, WWTW and nearby Heliport

Collection of Baseline Data

During the initial Scoping meeting statutory consultees raised concern with respect to the number of development proposals in the area and their combined potential effect on the adjacent Severn Estuary and its designations. Particular concern related to the potential disturbance to overwintering bird populations. Schemes identified as a result of consultation included the Cardiff Bay Barrage project, which was already under construction at the time, and the proposed relocation of a heliport, in addition to the WWTW and peripheral distributor road.

Although consultees commented on the need for strategic environmental assessment this was considered to lie outside of what could reasonably be expected of a single developer.

Information was obtained from the relevant bodies (Cardiff Bay Development Corporation, the British Trust for Ornithology and Countryside Council for Wales) on the ongoing surveys and assessment of the disturbance impact of the Cardiff Bay barrage project on the numbers and distribution of overwintering birds.

Assessment and Reporting of Impacts

The WWTW Environmental Statement was limited to assessing the potential impact on areas which may in the future be used for bird feeding grounds, due to populations being displaced as a result of the other development projects, as well as on areas known to be used at the time of the assessment.

The assessment of the cumulative impacts of a number of developments on the ecology of the area was undertaken and reported as an integral part of the assessment of the WWTW. This assessment used the significance criteria and methodology already developed for ecological impacts.

Evaluation of the Methodology Used and Implications to the Project

The consultation method was a useful and successful approach in determining other development projects in the area and in identifying at an early stage in the assessment, the potential for indirect and cumulative impacts.

Meetings with consultees at the scoping stage of the project facilitated the identification of such impacts and sources of baseline data at this early stage of the process. Further potential impacts were identified as part of the data collection and assessment stages of the project.

The success of such an approach was largely due to ongoing consultation and establishing close links with statutory and non statutory bodies. This provided a forum for the exchange of information, review of the project and reassessment throughout the Environmental Assessment and overall project co-ordination to draw together specialist inputs and identify further impacts.

The case study demonstrates the usefulness of joint consultation to facilitate the exchange of ideas, co-ordination of specialist inputs and the need for indirect and cumulative effects to be reassessed as the project progresses to the publication of the Environmental Statement and beyond.

By identifying possible cumulative and indirect impacts at the Scoping stage of the project it was possible to ensure that these issues were taken into consideration during data collection and assessment. Although consideration of the impacts required additional data to be collected, the implications to resourcing and programming of this project were considered not to be significant, largely due to the free exchange of information and the co-operation of those in ownership of the data .

CASE STUDY C - HIGHWAY E18: LOHJA - SALO, FINLAND

Methods Used: Consultations & Questionnaires, Expert Panel, Modelling and Matrix

Background to the Project

A number of options for the provision of a direct motorway link between Lohja and Salo have been considered, two of which have been developed and studied in further detail. The two options are to either upgrade and improve the existing road (referred to as Option A in this case study) or to provide a new motorway (referred to as Option B in this case study). An Environmental Assessment of the two options was carried out to establish what the possible environmental impacts would be and to assist in determining the preferred route. The scheme was categorised as a development which falls under Annex 1 of the EA legislation and for which an Environmental Statement is a mandatory requirement.

Detailed design of the road options had not been carried out at the time of the Environmental Assessment. The assessment was therefore only able to consider the impacts of the two routes in principle.

Overview of the Methodologies

The Environmental Assessment was undertaken by a team of specialists and co-ordinated by a project manager.

The assessment of the two options considered possible cumulative and indirect impacts. A scoping study was undertaken to identify the most important issues, but no formal scoping document prepared. Detailed consultations with statutory bodies and the public were carried out.

An Environmental Group, comprising a panel of experts associated with various aspects of the project, was set up to consider the environmental issues arising from the project. The Group met on a regular basis to discuss the potentially significant impacts and possible solutions which included the consideration of indirect and cumulative impacts. A matrix identifying the significant issues was used as the basis of the scoping exercise and for discussions by the Environment Group. The main sensitive receptors that were identified as potentially experiencing significant impacts included human beings, ground and surface water and wildlife.

The potential cumulative impacts of noise arising from the existing road and the proposed new road were identified, as were possible indirect impacts on the communities and their structure from possible severance and change in traffic movement patterns.

Baseline information on the natural resources of the study area had already been collected for previous studies undertaken. Further information was collected for the assessment of the potential impacts on the community structure. This comprised questioning residents, owners of summer cottages in the area and local businesses for their opinions on the road link and the impacts that the two options may have on them.

A number of different methods were used to assess the various indirect and cumulative impacts that were identified through the Environment Group discussions. The assessment of the indirect and cumulative effects was based on the same significance criteria as that used for the direct impacts. Information on the local community, based on that provided by the questionnaires, public meetings and meeting with the local authorities, was used in the assessment of indirect impacts on the community. The potential cumulative impacts of noise generated by two roads in close proximity was assessed by carrying out noise modelling.

The table below has been compiled to show in a summarised form some of the indirect and cumulative impacts that were identified in the assessment.

Table 1 - Some Potential Indirect and Cumulative Impacts Identified

Impact	Comment
Indirect impact on surface and ground water quality from salting of road.	Issue identified at scoping stage and assessed impacts of both options, based on expert opinion.
Indirect impact on level of water in lake above the road.	Identified as a potential issue after scoping stage based on expert opinion. Geology of area contains lots of fissures, lake could potentially drain if road affected bedrock of lake and water table.
Indirect impact on community structure	Used questionnaires to gather information on use of facilities and identify local concerns. Provided basis for assessment.
Indirect impact from mitigation - e.g. bridges constructed to allow deer/elk to cross; and noise barriers	Not considered in detail at this stage only in principle. No detailed design of structures/mitigation measures available.
Cumulative impact from noise of existing road and Option B, with and without mitigation.	Identified at scoping stage and assessed using noise modelling. Noise contour maps produced.

Detailed examples of indirect and cumulative impacts identified within the E18 Highway study area, are outlined below.

Example 1: Indirect Impacts on Community and Businesses

Collection of Baseline Data

The scoping stage of the assessment identified that the impacts on communities were potentially significant. Questionnaires and meetings with residents, businesses and local authorities were used to gather information on the opinions and concerns of residents and business operators who would be affected by the provision of the motorway and its links, during both the construction and operation phase.

Assessment and Reporting of Impacts

Both options would affect the flow of traffic and movement in the communities along the route, in particular Route Option B would divert traffic away from some communities (including businesses) and also result in some severance of communities in other areas. The motorway would have both an immediate impact on movement and the use of some facilities, and a more subtle impact apparent only over time.

The information gathered from the questionnaires and meetings provided the basis for the assessment of the indirect impacts on the communities. For example, the indirect impacts on bus companies currently operating in the area was considered. The assessment used data on existing routes, travel times and customer base and considered these against the possible new routes and diversions that the buses would have to make and how the passengers, and therefore the business, would be affected.

Example 2: Cumulative Impacts of Noise

Collection of Baseline Data

Route Option B would run alongside the existing road for part of its length passing a number of residential areas. Existing background noise levels were determined at certain receptor points.

Assessment and Reporting of Impacts

The combined impacts of noise from the existing road and potential new motorway on receptors were assessed. The predicted noise levels from both roads were modelled to establish where there would be a significant increase, both with and without mitigation (noise barriers).

The results of the assessment were illustrated on noise contour maps, the contours representing the predicted noise levels from the roads.

Evaluation of the Methodologies Used and Implications to the Project

The questionnaires were a useful tool for gathering baseline information on the local communities that would be affected, and assisted in identifying potential indirect impacts, particularly characterising the spatial impacts. However, assessment of the indirect impacts on a community are more difficult to accurately predict. Pre-determining the response of human beings is itself problematic, particularly when considering the more long-term impacts, where there may often be outside influences not associated with the road affecting the outcome.

An expert panel can bring useful knowledge from previous experience in assessing relevant types of impact. It is also useful in that as the project develops and mitigation measures are considered these can be designed to minimise any indirect impact that they might have. Monitoring of communities affected by roads would provide important data to be used in similar circumstances.

Modelling enables the predicted impacts to be quantified, and is particularly useful in assessing the cumulative impacts of more than one development in the same area. It also allows for more than one scenario to be considered whilst using the same baseline data, for example in this case with or without mitigation measures, or with higher levels of traffic using one particular route. The results for the different scenarios can then be compared.

A disadvantage of the modelling method is that it can be costly, particularly if the baseline data is not readily available; where cumulative impacts need to be considered for long lengths of road; and, where there may be a large number of receptors.

CASE STUDY D - CENTRAL SEWAGE TREATMENT PLANT, TURKU, FINLAND

Methods Used: Consultations and Questionnaires, and Checklist

Background to the Project

A new waste water treatment facility for the city of Turku, South Finland was required. Two sites in the city centre were assessed, one located underground beneath a prison; the other on an area of open ground.

All the main sewerage infrastructure was in place and therefore there was no need to include the provision of pipelines in the Environmental Assessment. It was not possible to include the effects of the new facility on the existing small waste water treatment facilities on the edge of Turku due to the fact that they were outside the boundary of the municipality.

The project was classified as a development falling under the Annex II category.

Overview of the Methodologies

The Environmental Assessment was carried out by a team of specialists co-ordinated by a project manager.

Scoping of the assessment was carried out to identify the impacts that were considered to be significant, this included the use of a checklist. The local authorities assisted in the scoping process providing baseline information on the study areas as well as their concerns and views on the potential impacts of the project. A formal scoping document was produced which was discussed with the local authorities and environmental departments, and also presented to the public. Following this the final scope of the assessment was agreed.

The following checklist was used to assist in identifying the potential significant impacts on natural resources, the built environment, human beings and society. The potential for cumulative impacts on the amenity of people was identified.

Data was gathered through consultations and meetings with statutory bodies and through questionnaires. These were used to gather information on the values of those in the localities of the two site options, for example on land use, townscape, air quality and odour, noise and traffic. The information provided a baseline against which the cumulative impacts on human beings resulting from the project could be assessed.

The assessment examined the potential impacts predicted to occur as a result of the construction and operation of the waste water treatment facility on either of the sites.

	Impacts on environment						Impacts on built environment				Impact on Human Beings and Society			
	Soils and Geology	Surface and groundwater	Air and climate	Flora and fauna	Urban structure and planned land use	Buildings and structures	Landscapes and townscape	Cultural heritage	Health, smells, noise and vibration	Quality of life and recreation	Economic life and employment	Use of natural resources		
Construction														
ground preparation work	✓	✓	✓			✓	✓		✓	✓		✓		
surface structures					✓	✓	✓			✓				
Operation														
treatment of waste water		✓	✓	✓	✓			✓	✓					
intake and removal of air								✓	✓					
treatment of sludge			✓		✓			✓	✓					
Transport														
traffic			✓		✓			✓	✓					
Exceptional circumstances														
disturbances in operation		✓	✓	✓				✓	✓			✓		

✓ Indicates which issues the project is assumed to have an impact on. Where a symbol is not present, this indicates that a significant impact is not likely to arise.

The table below has been compiled to show in a summarised form some of the indirect and cumulative impacts that were identified in the assessment.

Table 1 - Some Potential Indirect and Cumulative Impacts identified

Impact	Comment
Indirect impacts from decommissioning of pumping stations.	Impacts considered briefly in principle.
Cumulative impact of odour from a combustion plant and the WWTW facility.	Combustion plant planned for development in the same area as one of the site options for the WWTW facility. Detailed odour assessment carried out after the ES was submitted.
Cumulative impacts on human beings from a variety of impacts resulting from the project.	Identified as a potentially significant impact at the scoping stage and assessed in the ES.

A detailed example of cumulative impacts identified within the study area of the Turku WWTW are outlined below.

Example 1: Cumulative impacts on human beings

Collection of Baseline Data

Baseline information on the values of people in the areas likely to be affected by the project was gathered mainly through the use of questionnaires. Other information, for example the existing volume of traffic on certain roads, was obtained through consultation with the local authority and other statutory bodies.

Assessment and Reporting of Impacts

Calculations of the noise generated, particularly by construction traffic and excavation, were made and noise levels predicted for both site options. The municipality had identified the routes traffic would take; and the traffic levels were calculated for these routes in comparison to existing levels.

The visual impact of the facility, in particular the stack, at both locations was considered. Photomontages were prepared to provide an impression of the visual impact of the facility and its effects on the townscape.

The various impacts of noise, odour and visual intrusion were considered together in terms of the overall cumulative impact on humans (the receptor)

within the study areas, and the significance of these impacts taken together assessed.

Evaluation of the Methodologies Used and Implications to the Project

The information provided by the responses to the questionnaires was useful in that it assisted in identifying the important environmental elements for the people in either of the localities close to the two site options. For example, uncluttered views, quiet roads or good air quality. A disadvantage of basing an assessment on 'values' is that it becomes very subjective. The assessment of the overall impact on humans drew together the individual impacts and provided a useful guide for comparison of the two site options.

The checklist was a useful way of identifying where potential cumulative impacts may occur at the early stage of the assessment. The consideration of the cumulative impacts on people played an important part in discussions surrounding the project.

CASE STUDY E - STRATHCLYDE CROSSRAIL, UNITED KINGDOM

Methods Used: Checklists, Consultations and Questionnaires

Background to the Project

The scheme comprises a new passenger rail route across Glasgow City centre. The scheme would be 3.5km in length which includes two new sections of railway and an existing section of freight line to be electrified. Along the route there would be five stations (new and modified). Ancillary development associated with the scheme includes the erection of overhead line equipment, signalling, lighting and signage for each station. The sewerage network would have to be diverted as part of the scheme, and a pumping station located at one of the stations would have to be relocated. The route across the city centre would pass through areas of industry, commercial development and residential areas, and would cross the River Clyde. There are a number of listed buildings along the route, which also runs through a Conservation Area.

The Environmental Statement was prepared to accompany the application for consent to develop the railway, which will be made under the Private Legislation Procedure (Scotland) Act 1936.

Overview of the Methodologies

A formal Scoping Report was prepared and circulated to over eighty statutory and non statutory consultees including Strathclyde Regional Council, Glasgow District Council, Members of Parliament, Community Councils and Railtrack. This Scoping Report identified potential indirect and cumulative impacts and impact interactions that would be addressed within the Environmental Statement. The Scoping Report included a separate section on the proposed assessment of secondary and cumulative effects. These included the effects on car parking provision at stations where travel patterns change as a result of the CrossRail, the release of operating capacity on the rail network and the ability to re-route trains and operate the network more efficiently, and the need for and effects of additional infrastructure which may be required (depots, extensions to existing platforms). The Scoping Report noted that by their nature, these effects, and their assessment, could only be considered once the detailed scheme design and assessment of first order effects were fully underway. The report also noted that, in addition, any assessment of secondary effects was likely to be of a broad qualitative nature. The Scoping Report set out the proposed structure for the Environmental Statement and identified the Chapter assessing the Interaction of Effects and Cumulative Effects as a key Chapter which would draw together the assessment work.

Baseline data was collected taking into account the assessment of potential indirect and cumulative impacts and impact interactions. However, the author advised that the availability of data, particularly data from the Regional Traffic Model and data relating to modal transfer, influenced which indirect and cumulative impacts and impact interactions were considered in depth. A professional judgement was made with respect to which issues justified further data collection, for example detailed assessment for wider traffic impacts and car parking issues was not undertaken as a result of insufficient data being available to enable modelling of the impacts.

The indirect impacts were considered as an integral part of the assessment using the same approach and significance criteria as for the direct impacts. Although not produced in the Environmental Statement, the following table has been compiled to show in a summarised form the types of indirect impacts that were identified within the main topic Chapters and how they were addressed in the Environmental Statement.

Table 1 Types of Potential Indirect Impacts Identified

Impact	Comment
Knock-on effect of regeneration	A review was undertaken of development plans for the area. The effects were not specifically addressed in detail in the Environmental Statement.
Access to businesses as a result of severance and displacement of car parking	No specific method was adopted for an overall assessment. Data was however used from car park surveys based on capacity and level of usage.
Wider traffic movement impacts	Considered impact on city-wide traffic patterns with reference to SITM model. A detailed assessment was not undertaken.
Greenhouse gas emissions	Considered effects from energy used from operating trains but the benefits from the switch from car to rail were not able to be quantified.
Air quality	No traffic model was available to predict the effects of modal transfer due to insufficient traffic data. Only a limited assessment was undertaken.
Access to community and commercial resources improved	Used a questionnaire to gather information on local business activities, and consultations with interest groups.
Temporary access, routing and parking issues during construction	Based on expert opinion and worst case assumptions. The Environmental Statement included a table of construction compounds and roads affected and examined specific areas and construction impacts on them.

A separate Chapter addressed the interaction of effects and cumulative effects. The introduction to this Chapter stated that cumulative effects are those which result from the “incremental impact of an action when added to other past,

present and reasonably foreseeable actions. Essentially, cumulative effects can be viewed as being the consequence of multiple sources of disturbance that affect valued environmental resources.”

The assessment method given for this Chapter stated that the assessment is based on the concept that all impacts (air quality, noise, visual intrusion etc.) ultimately have an effect in the following three broad areas which comprise the principal elements of the environment:

- Amenity: encompassing both public use and perception;
- The resource base: natural resources and land; and
- Material assets: infrastructure, buildings or historical/ cultural features.

The Chapter recognised that such effects maybe long or short term, reversible or irreversible, adverse, neutral or beneficial. The impacts in any identified location were assessed in terms of their likely effects on these three constituent elements based on the significance of the impacts identified in the preceding Chapters. The conclusions of the assessment were used to produce a preliminary table of results, in which all receptors for all subject areas were listed, together with the assessment made. This process revealed that, while some localities or features were reported in several subject areas, some features were reported only once. To provide a manageable assessment of cumulative effects, the process concentrated on the key geographical areas and receptors. This acknowledges that a variety of receptor types located in the same area may be considered together.

The Environmental Statement included a summary of the key environmental impacts in tabular form (an extract from the table of cumulative impacts (Appendix J of the Environmental Statement) is reproduced for information). Four geographic areas were selected to correspond with the coverage of the map based Figures. An overall assessment of the interaction between a number of effects on a particular receptor were also described in the Chapter. Noise, socio-economic issues, townscape, visual intrusion and cultural heritage were identified as being the subjects which were likely to have important cumulative effects over the length of the proposed scheme. The introductory section of the Chapter states that where the cumulative assessment results in an overall level of significance greater than the individual level the potential for consideration of further mitigation measures are to be highlighted.

Detailed examples of indirect and cumulative impacts within the Strathclyde Crossrail study area are identified below.

Example 1: Indirect Impact - Traffic, Movement and Access

Collection of Baseline Data

Potential indirect impacts on traffic, movement and access were identified through the Scoping process. Within the Scoping Report the potential principal issues were identified as: ensuring adequate provision for the interchange with other forms of public transport; car parking; access and movement for pedestrians, cyclists and the mobility impaired in relation to the proposed development and ensuring that road traffic generated by the proposed development did not have an adverse impact on its immediate locality. The Scoping Report also noted that with respect to strategic issues, the effects of improved access to the city centre and across the city, such as pedestrian movements between Central and Queen Street Stations, were positive benefits of the scheme which would be reported.

The assessment of potential direct and indirect impacts used information supplied by Strathclyde Passenger Transport Executive (SPTEx) and Strathclyde Regional Council (SRC) Roads. This took into consideration the assessment of effects undertaken in the Strathclyde Transport Development Study Scheme Appraisal Report. Data used included car park surveys in 1992. The assessment used the SPTEx multi-modal model to some extent. However, the data available was insufficient and the model could be used to assess the detailed effects on traffic movements and access. Due to the lack of quantitative data, significance criteria was not developed or applied and the assessment was based on whether the scheme would be adverse or beneficial.

Assessment of Impacts and Reporting

The assessment considered the impact on local roads and pedestrians. This included an assessment of impacts from the severance of Bell Street which would result in existing traffic having to use Gallowgate and one of the interconnecting streets to Bell Street. As a result the change in traffic movements in these interconnecting streets may have an adverse effect on the access arrangements for businesses serviced from them. Conversely, access to and from the residential property served by the west end of Bell Street may be improved.

The assessment also considered the loss of off-street parking spaces and identified that further studies may be required to determine the extent and displacement of parked vehicles to other locations and the consequent impact on traffic flows.

With respect to future developments, the effect of the Millennium plan which was at the time being developed for the city centre, was considered. It was identified that this strategy could potentially significantly alter the provision of

public transport, pedestrian and vehicular circulation. The proposals which were current at the time were reviewed in the vicinity of all stations in order to ascertain the potential effect on the Strathclyde CrossRail. It was considered that the effects of the proposals on traffic, movement and access would be relatively limited.

The report concluded that the CrossRail was expected to bring about a modal shift from the private car to the railway network, however this effect was not quantified.

Example 2: Cumulative Effects - High Street, Glasgow Cross

Collection of Baseline Data

The approach to the assessment included delineation of sections based on the sensitivity of the receptors. The direct impacts, which were predicted for each geographical section, were then considered together in order to determine the different types of impacts and the significance of such impacts on an individual receptor (for example a business), or more commonly, a group of receptors (e.g. a residential area).

Within the High Street, Glasgow Cross Area the route was divided into three sections for which cumulative impacts were considered. These were:

- College Lands/ Parsonage Square/ Bell Street
- Gallowgate to London Road
- Saltmarket, Osborne Street

Within each of these sections the Environmental Statement addressed the three principal elements of the environment (amenity, the resource base and material assets as previously described).

Assessment of Impacts and Reporting

Within the College Lands/ Parsonage Square/ Bell Street sections the Environmental Statement identified potential impacts as a result of visual intrusion to residential properties, a change in accessibility as a result of the severance of Bell Street and the public perception of the proposed pedestrian underpass. Improved access to High Street Station was also identified as a positive impact within this area.

The assessment concluded that there would be no impact on material resources. However the potential was identified for disturbance to the valuable archaeological resource at Bell Street; relocation of 29 flats; demolition of part

of a listed Stables Block (historical interest) in Bell Street; loss of a car park and land from a business; and loss of railway arches also used for business.

The extract from Table J shows in more detail impacts identified and assessed for this area. The Environmental Statement concluded that overall the impact of the scheme would be mitigated by the overall strategic benefits.

Evaluation of the Methodologies Used and Implications to the Project

The consultation exercise and Scoping study was used to identify the potential indirect and cumulative impacts and impact interactions. Such impacts were considered and assessed as an integral part of the EA.

The Environmental Statement included a specific Chapter on Impact Interactions and Cumulative Effects. With a linear scheme, such as a railway development, considering impacts within a defined geographical area enabled consideration to be given to the combined effect of a number of impacts on a localised area. An indication of the number and different types of impact which a receptor, or group of receptors, may experience could thus be identified. The geographical areas were defined according to the evaluation of their sensitivity to change.

The geographical area approach is useful for linear type developments, such as railways, roads, pipelines and road schemes. The approach provides a clear explanation of the predicted impacts within a specific locality and, as such, is a useful tool in terms of conveying the effects of the scheme to the public who are likely to be interested in the impacts for possibly only a short section of a route. One problem however, which is recognised within the Environmental Statement, is its difficulty addressing and reporting impacts on an 'area wide' scale.

The author advised that assessment of indirect and cumulative impacts, as well as impact interactions were identified at the Scoping stage of the project and therefore these were not considered to result in any additional resourcing requirements. The author did however, advise that the availability of suitable data was important in determining which indirect and cumulative impacts and impact interactions were able to be considered and assessed in depth. For example, further assessment of wider traffic issues and the effect of loss of parking spaces and the resulting displacement could have been assessed if sufficient data had been available.

The author advised that although throughout the project indirect and cumulative impacts and impact interactions were consciously considered, they were only considered in detail towards the end of the scheme design process and therefore had little influence on design issues.

Extract from Appendix J.1.: Table of Cumulative Effects: High Street to Glasgow Cross

	Traffic, Movement & Access	Noise & Vibration	Air Quality & Electromagnetic Radiation	Water Resources & Contaminated Land	Nature Conservation	Townscape & Visual	Cultural Heritage	Socio-economic Issues	Construction Activities
General Corridor Wide Effects	General improvement to accessibility on east side of city centre.	Not significant. The ambient noise level is controlled by road traffic noise	Changes in air quality likely to be not significant to minor beneficial	No significant effects are envisaged	No significant effects are envisaged	Overall moderate adverse effect on townscape and visual amenity	Moderate adverse effect on setting of Conservation Area	Improvement in pedestrian accessibility to socio-economic resources on east side of city. Moderate to minor beneficial	
High Street/ College Goods Yard	Kings Car Park removed. Moderate adverse. Loss of 20 spaces from SRC car park. Minor adverse.						Encroachment into an area of high archaeological interest. Major to moderate adverse effect.	Loss of Kings street Car Park. Moderate adverse. Loss of land from Scottish Studio Engravers. Minor adverse.	Temporary loss of Hunter Street car park Access arrangements to Scottish Studio Engravers adversely affected.
High Street Station	Walking distance increased by 80m. Minor adverse. Mobility impaired persons access from High Street Station to platforms.							Loss of eight archway units on Molendinar Street. Minor adverse.	

Extract from Appendix J.1.: Table of Cumulative Effects: High Street to Glasgow Cross (cont)

	Traffic, Movement & Access	Noise & Vibration	Air Quality & Electromagnetic Radiation	Water Resources & Contaminated Land	Nature Conservation	Townscape & Visual	Cultural Heritage	Socio-economic Issues	Construction Activities
Bell Street	Severed to road traffic. Traffic re-routed on local network. Potential improvements for access to remaining properties. Perceptual changes to pedestrian route along Bell St. Minor adverse effect.					Demolition of Stables Block - moderate adverse effect on the local townscape. Moderate to minor adverse effect on properties overlooking the alignment.	B listed building demolished, Major adverse effect. Setting of Conservation Area and remaining buildings affected - moderate adverse effect.	Loss of 29 residential units on Bell St. - minor adverse effect. Minor adverse effect on businesses in Bell St./Hunter St./Gallowgate from severance of Bell St.	Access to Bell St. Limited during demolition of Stables Block. Utilities affected with construction of new railway embankment. Increased HGV movements.
Precious Recording Studio			Electromagnetic radiation sensitive location					Demolition of two units rendering studio inoperable. Moderate adverse effect.	
Saltmarket and Osborne Street						Moderate visual intrusion to upper 2 storeys of residential properties		Partial demolition of Kenmar Sports Shop. Moderate adverse effect.	Areas affected during station construction.
Saltmarket Place							Changes to setting of Conservation Area. Minor adverse .	Changes in amenity of residential units. Moderate adverse.	Temporary landtake from gardens and car park

CASE STUDY F - REGINA TO STROMONA SECTION OF THE EGNATIA MOTORWAY, GREECE

Method Used: Geographical Information System (GIS), Checklists, Networks, Consultation and Modelling

Background to the Project

There are proposals to construct a major road scheme between Igoumenitsa and Thessalonika that will provide a link between Greece and Turkey. The area is already popular for tourism, and the objective of the road construction is to improve access to this region and therefore facilitate tourism and associated economic benefits. The selected route crosses a coastal plain which is predominantly flat and largely undeveloped. The area is of particular interest for sites of archaeological importance.

The Environmental Statement assessed one part of the proposed road development (a 32km section between Thessalonika and Strimona).

Overview of the Methodology

The Environmental Statement was undertaken by a team of in-house and specialist sub consultants, co-ordinated by a project leader. The assessment utilised checklists, networks, consultations and physical and mathematical modelling to identify and assess potential indirect and cumulative impacts, as well as impact interactions. Checklists were considered to be the key tool used in identifying such impacts.

Although no formal Scoping Report was prepared for the scheme, the project team carried out an informal Scoping exercise and consulted with the authorities and statutory bodies. Public meetings and participation was an important element of the project.

Different study areas were used depending on the particular environmental parameter that was assessed. For example, for some parameters a 30km wide corridor was selected for collection of baseline data, In some other cases the study area extended as far as the Greek border.

A significant amount of baseline data was collected for the scheme and this was used to develop a Geographical Information System (GIS) specifically for the project. Information entered onto the GIS included climate and topographical data. The GIS covered a wide area that extended beyond the proposed road alignment.

The Environmental Statement took into consideration planned developments (this included new settlements and agricultural developments) when carrying out the impact assessments. However, it acknowledged that although the impact on proposed development could be assessed, once operational the road would encourage further growth of the region that could not be predicted at the time of the Environmental Assessment.

The Environmental Statement included a separate chapter for each topic (sensitive receptor) which described the existing environment and assessed the impacts identified.

Although not produced in the Environmental Statement, the following table has been compiled to show in a summarised form examples of the type of impacts that were identified and how they were addressed in the Environmental Statement.

Table 1 Types of Potential Impact Interactions and Indirect Impacts Identified

Impact	Comment
Impact of traffic emissions on archaeological sites	Potential for exhaust emissions to take part in chemical reactions to produce other compounds (secondary pollutants) whose environmental effects are different.
Impact of traffic emissions on agriculture	Potential for deposition of particulate pollution (lead) in areas used for agriculture resulting in introduction into the food chain. This potential indirect impact was considered by the project team to be widely recognised and the assessment therefore referred to existing research and assessments on this subject.

Detailed examples of indirect and cumulative impacts identified within the Egnatia Motorway study are outlined below:

Example 1: Impact Interaction and Indirect Impact on Archaeological Sites

Collection of Baseline Data

Data collection and development of the GIS identified many sites of archaeological interest in the area surrounding the proposed road alignment. Although there would be no direct impact on these features, the potential was identified for indirect impacts as a result of the interaction of pollutants from exhaust emissions. Data was also collected on meteorological conditions for the study area.

Many of the emissions from traffic can react together with pollutants from other sources to form secondary pollutants which can also have significant effects. As they disperse widely in the atmosphere during the time taken for reaction,

the concentrations of secondary pollutants are not always the highest near to the source of the emissions. Their impacts may therefore be spread over large areas and not confined to the locality of the traffic that emitted the pollutants.

The main precursors of acid deposition are sulphur dioxide (SO₂) and nitrogen oxides (NO_x) emitted into the atmosphere from both natural and made sources. The vehicle contribution is mostly of NO_x. However NO_x may influence the rates of photochemical oxidation of both SO₂ and NO_x. Oxides of nitrogen react with other chemicals with acidic properties in the air, contributing to 'acid rain' which may cause damage to buildings - in this case archaeological sites.

Assessment and Reporting of Impacts

The Environmental Assessment used the GIS to identify archaeological sites which may indirectly be affected during construction (due to dust emissions) and operation of the road (vehicle emissions). Where significant impacts were identified, minor amendments were made to the route corridor to mitigate this impact during operation. In addition, vegetation screens were proposed prior to commencement of the construction of the road to act as a barrier to dust generated from the construction works.

Detailed laboratory testing to predict the magnitude of impacts was not undertaken. The project team considered that the operational impacts of the road could not be properly addressed based on the existing knowledge on this subject and due to time constraints on the project.

Evaluation of the Methodology Used and Implications to the Project

The GIS was a key element of the Environmental Assessment in terms of managing significant quantities of baseline data. It was also useful for predicting emission dispersion patterns and therefore potential impacts on archaeology (in addition to other environmental parameters). Modelling of the predicted emissions was also important in determining impacts resulting from interactions of the emissions.

The requirement to assess the indirect and cumulative impacts was considered at the commencement of the project. The project co-ordinator therefore considered that the implications to resourcing and programming of the project were addressed at this early stage. The GIS used to assess these impacts was a major part of the project and resourcing to develop this was significant. However, due to the scale of the project this was considered justifiable.

CASE STUDY G - SECURING THE KIEL CANAL (SECTION RENDSBURG EAST), GERMANY

Method Used: Network Analysis

Background to the Project

The Environmental Statement was prepared to assess the effects of stabilising the banks of a 5km section of the Kiel Canal. This would be achieved by setting back the banks and extending the canal cross section. The reason for the proposed works was due to the size of ships using the canal having increased, which has contributed to the erosion of the sub-water slopes and soil transportation. This in turn affected the stability of the banks and the safety of the canal for water traffic and other users.

The project required the dredging of spoil from both above and below the water level to extend the canal profile on both banks, but with the majority of the works taking place on the south bank. Dredged material would be used wherever possible on the new embankments. The remaining dry material would be deposited on land at tips at Osterrönfeld and Hochfeld and the wet spoil deposited to an approved spoil area at Flemhude See, 20km away.

The works on the southern bank would necessitate the demolition of a group of buildings and the clearing of trees and vegetation. Vegetation would also have to be cleared on the northern bank. A bridge and building would have to be removed and rebuilt, and services diverted (electrical lines/cables). The lower reaches of a tributary, the Wehrau Brook, would have to be diverted as a result of the works.

Section 3 of the Environmental Impact Assessment Act, Bundesgesetzblatt 1990, required that the Waterways and Shipping Administration, as the responsible authority, carry out an Environmental Assessment. The developer of the project, Neubauamt Nord-Ostsee-Kanal was required to submit the Environmental Statement, project description and compensation plan to the approving authority.

The stretch of the canal to be stabilised includes that to the west of Rendsburg to the Audorfer See. There are a number of buildings along this part of the canal, together with agricultural land. The town of Rendsburg is located in the north of the Investigation Area (IA), the villages of Osterrönfeld and Schacht-Audorf in the south. The canal is crossed by a railway line, with a ferry operating below the bridge. The Wehrau Brook flows into the canal on the south side.

Overview of the Methodology

The Environmental Statement was prepared by a team of specialists and coordinated by a project manager.

Scoping was carried out to determine both the spatial and temporal extent of the study, and to define the content of the assessment. The scoping process included meeting with consultees, the responsible authority and the developer to discuss the project. The need to consider specific impact interactions was not identified at the scoping stage, this emerged following the establishment of the existing conditions within the Investigation Area. The assessors, not the developers or planners, considered that it was necessary to look at interactions. No further data, over and above that required for the assessment of the direct impacts, was collected in order to make the assessment of the interactions.

The Environmental Assessment carried out identified a number of impact interactions and indirect impacts that could arise as a result of the scheme. These impacts were established as a result of undertaking a network analysis. A flow diagram was prepared which illustrated the impact relationships between the effects of the various activities associated with implementing the project, the individual elements of the receiving environment and land use functions (social receptors). The flow diagram showed a very complex system of interactions, in particular illustrating the central functions of flora and fauna within the environment. The large number of interaction paths shown between the elements demonstrates that an impact on one of the key elements has a high potential to cause major change in an overall ecosystem.

A specific chapter within the Environmental Statement addressed the interactions within specific sectors of the environment, for example soil, vegetation, landscape, leisure and recreation and water. The assessment of the significance of the interaction impacts was based on the significance criteria used when considering the direct impacts. The significance was based on the degree of change (intensity of impact), duration of the impact and the spatial extension of the impact.

The author advised that it would have been possible to have modelled some of the interactions to try and quantify them, but it would have been very complicated and time consuming (and therefore a lot more costly). The interactions found were presented in the report in both text and diagram format, a separate chapter set out the assessment of the impact interactions and the diagram, which is reproduced here, shows the interrelations and responses within the system.

Although not produced in the Environmental Statement, the following table has been compiled to show in a summarised form the type of interactions that were identified and how they were assessed.

Table 1 - Some of the Potential Impact Interactions and Indirect Impacts Identified

Impact	Comment
Loss of vegetation during construction from setting back of the canal banks, diversion of the Wehrau Brook, and storage and disposal of removed earth and dredge spoil.	Identified as an issue through the network analysis. The interaction diagram shows that terrestrial vegetation influences elements of the environment including landscape, fauna, microclimate and groundwater, which in turn are related to and therefore affect other elements of the environment
Disposal of spoil from dredging to Osterrönfeld and Hochfeld tips.	Identified as an issue through the network analysis. The relief of the tip areas will be changed by the disposal of dredged material, and the existing soils would be sealed by the new material placed on top of them. The nature of the flora and fauna which will colonise the areas may be different to what existed previously. The change in soil properties may also influence the volume and quality of water seeping from the dredged material, in turn affecting the quantity and quality of ground water.
Impact on water quality.	Identified as an issue through the network analysis. The systems diagram shows the links between volume of water, flow conditions, water quality, sedimentation and aquatic vegetation and fauna.

Detailed examples of indirect and cumulative impacts identified within the Kiel Canal study area are given below:

Example 1: Impact Interactions and Indirect Impacts - Vegetation

Collection of Baseline Data

Interactions were defined as the cause-effect interrelations between and within components of the ecological system which might be direct or indirect.

Vegetation surveys were undertaken to determine the habitat type and identify any endangered species. Surveys of the fauna present within the study area were also carried out. This data was used to determine the various habitats within the study area and the interaction pathways of the components of the habitat.

Assessment and Reporting of Impacts

The loss of vegetation would occur as a result of the setting back of the banks, the storage and disposal of spoil, the diversion of the Wehrau Brook and the construction of a berm road. The direct impacts on the vegetation would, as a result of the interactions between the elements, impact on the associated fauna which depend on the vegetation. There would be a correspondent change in

the habitat network, which would also influence the landscape and amenity of the area.

The damage caused during construction from the compaction of soil, change in groundwater level and changes in the micro-climate caused by the removal of vegetation would also impact on the habitat networks, causing shifts in the composition of the animal and plant communities. The shifts themselves influence the whole respective habitat and function in the ecological system.

These impact interactions and indirect effects were identified as a result of establishing the baseline conditions of the individual elements of the study area and carrying out a network analysis to identify how the individual elements relate to each other. The various activities during construction and operation of the extended canal were considered in terms of what effects they would have on those elements, and therefore other elements as a result of the interaction pathways. The role of the elements in terms of their effects on land use activities was also considered.

Example 2: Impact Interactions and Indirect Impacts - Water Quality

Collection of Baseline Data

The baseline conditions of the water quality within the canal had already been established for the assessment of the direct effects of setting back of the banks and dredging the canal.

Assessment and Reporting of Impacts

The proposed widening of the canal would increase the water surface and volume of water. Increases in the water body would affect the flow velocity which in turn would influence the water quality. Water quality is affected by a highly complex ecological system. The increase in mean depth and change to the slope gradient will affect the light penetration within the canal. If the euphotic zone becomes smaller the influence of algae on the oxygen and nutrient budget decreases, resulting in a reduction of the biogenic oxygen input. The relative enlargement of the non-euphotic zones would bring about an enhanced influence of bacteria on the oxygen budget and an increase in the oxidising and decomposing material. These interactions would be likely to reduce the oxygen content in the lower water layers of the canal, and therefore influence the structure of the flora and fauna within the canal.

From the network analysis and identification of the interaction pathways the impacts on activities reliant on water quality, for example recreation and fishing, were established. It was not possible to quantify the extent of the impact interactions and indirect impacts due to the lack of suitable models, time and money.

Evaluation of the Methodology Used and Implications to the Project

The network analysis and interaction diagram show that where impacts from projects are initially thought to be uncomplicated they can cause complex ecosystem reactions with significant impacts on the environment. The interaction diagram illustrates the interaction pathways between the elements of the environment clearly and which can be linked to specific activities associated with the project and their subsequent impacts on uses within the study area.

A disadvantage of the method is that it does not enable any quantification of the impacts in either a spatial or temporal scale.

The methodology used to assess the impact interactions and indirect impacts was felt by the author to provide a good understanding of the effects of the scheme on the receiving environment. The assessment of these interactions also assisted in fulfilling the requirements of the planning authority to consider the effects of the scheme on the environment.

The network analysis method did not require significant time or cost inputs over and above those required for the basic assessment. However, the author commented that such a method may identify the need for further compensation/mitigation (e.g. reinstatement costs) which the developer will have to bear.

The assessment of the impact interactions did not, in itself, influence the project but the Environmental Statement as a whole did influence the solution and the discussions with the planners. Discussions were also held with interest groups who were happy with the level of assessment carried out.

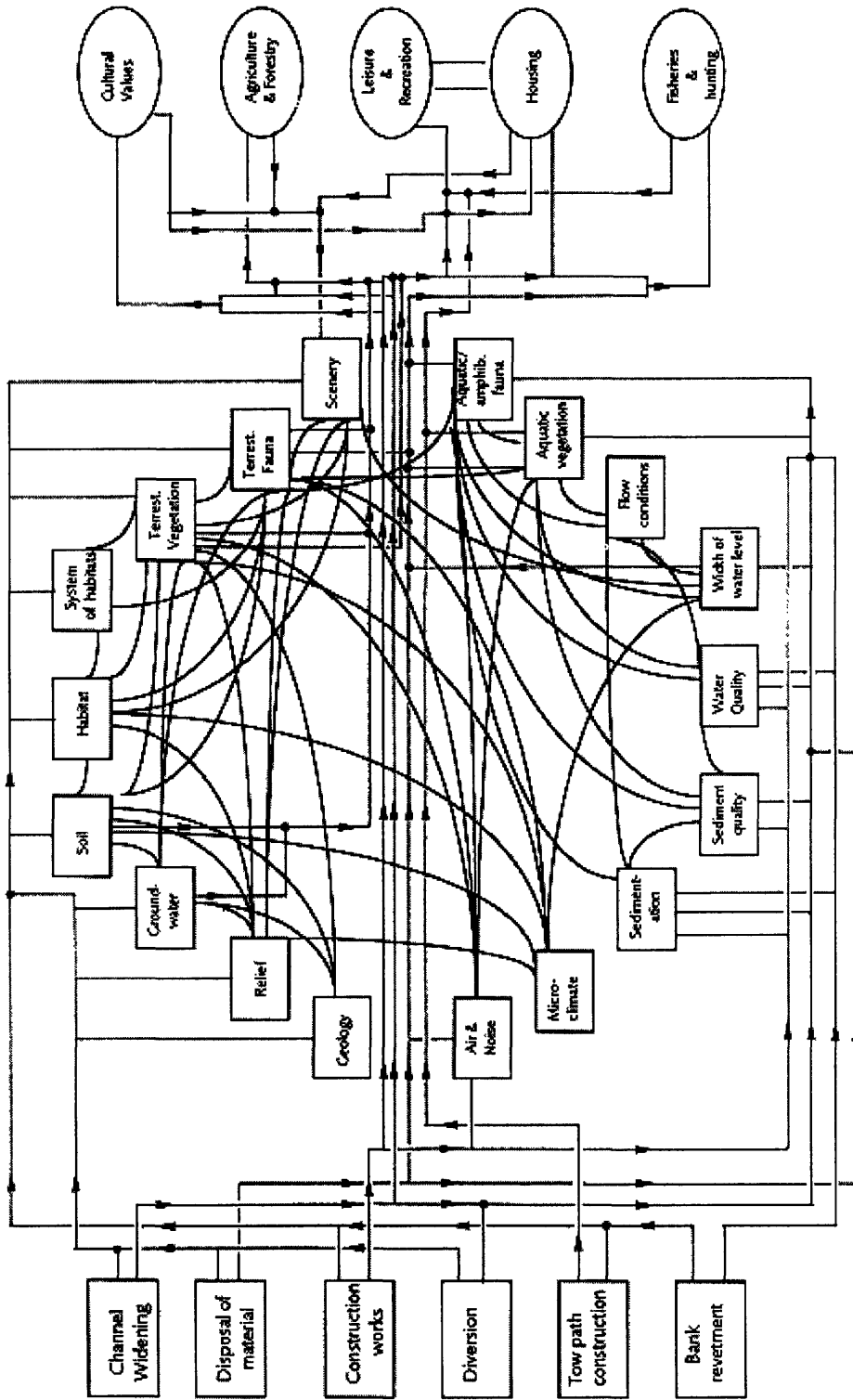

Adapted from Bundesanstalt für Gewässerkunde

CASE STUDY H - B452 REICHENSACHSEN BYPASS, GERMANY

Methods Used: Network Analysis, Overlay Mapping

Background to the Project

Traffic through the town of Reichensachsen, which is an historic settlement, has increased considerably and a bypass is required to relieve the effects of heavy traffic on the town and its residents. An Environmental Assessment was carried out to establish the route of least environmental impact, the findings of which were presented in the Environmental Statement. The scheme was categorised as a development which falls under Annex 1 of the EA legislation and for which an Environmental Statement is a mandatory requirement.

No details on the road design were available at the time of the assessment and as such only possible route options were addressed.

Overview of the Methodology

The Environmental Assessment was undertaken by a team of specialists and co-ordinated by a project manager.

Scoping of the Environmental Assessment was carried out. This comprised preparing a scoping document with the developer, meeting with the relevant authorities to discuss the project and scope of the assessment, and updating the scoping document. Within the document, the main issues of the project and a description of the likely major impacts were set out. In addition, an outline of the analysis that was to be done for each receptor, including analysis of the interactions, was given. The requirement to consider the impact interactions, as defined in the Environmental Assessment legislation, was expressed by the planning authorities.

A study area of 500ha was used in the assessment of the impacts of the proposed route options. The study area had already been defined for the project prior to the need to consider impact interactions. Information from consultations and surveys was used to establish the baseline conditions of the study area. Relevant environmental standards for the area were also established. The sensitive receptors were identified as being surface and groundwater, landscape, flora and fauna, residential areas and historic features associated with the town, and the ecosystems classified in terms of the impact interaction groups.

The Environmental Assessment examined the potential impacts predicted to occur as a result of construction activities, the physical presence of the road itself and the operation of the road.

The assessment was based on the classification of ecosystem types (interaction groups) in accordance with the approach developed by *Sporbeck et al.* This identifies the links between ecosystem components which are sensitive to a change in the environment and which react to those changes. From this the impact pathways can be defined. For each interaction group a network analysis, which included the use of matrices was undertaken to determine the overall extent of the sensitive areas and likely impacts.

The ecosystems within the study area sensitive to changes to individual elements were mapped to establish the spatial areas and route options. The route options were superimposed over the map to show where impacts would occur (see attached figure), including direct impacts and indirect impacts resulting from the interactions. The route options were then superimposed onto a map of the sensitive areas of the study area by means of an overlay to identify the route likely to have the least impact.

Impact interactions and indirect impacts were reported in a separate chapter within the Environmental Statement, supported by illustrations.

Although not produced in the Environmental Statement, the following table has been compiled to show in a summarised form some of the indirect impacts and impact interactions that were identified.

Table 1 - Some Potential Impact Interactions and Indirect Impacts Identified

Impact	Comment
Indirect impact from noise barriers	Considered in principle within the ES. Specific details were not available as the assessment was based on possible route options only. There would be an impact shift where the mitigation measure for minimising noise would cause an impact by creating a physical barrier for fauna needing to cross the road. It would also create a visual impact.
Impact interaction - severance of a wetland ecosystem by the road.	Used network analysis and matrix to identify the impact interactions from routing a road across a wetland habitat.

Detailed examples of indirect and cumulative impacts identified within the Reichensachen Bypass study area are outlined below:

Example 1: Impact Interactions - Impact on wetland ecosystem

Collection of Baseline Data

A survey of the study area, together with consultations, established the baseline conditions. One of the ecosystem types that was identified was classified as a wetland.

Assessment and Reporting of Impacts

A network analysis for the wetland was carried out to identify the interaction pathways and areas sensitive to a change in the individual elements. For example, where the groundwater in the wetland would be affected this would in turn impact upon the soil ecology, flora and fauna of the area. Further linkages between impacts on the ecosystem and visual elements of the landscape were also demonstrated.

The extent of the sensitive wetland area was modified to take account of the interactions and mapped. The route options for the road were then overlain on the maps to determine where the impacts would occur directly and also indirectly, resulting from the interactions likely to occur.

Evaluation of the Methodologies Used and Implications to the Project

The level and complexity of the assessment of the interactions depends upon the receiving environment and therefore influence the method used to assess such impacts. If there are ecosystems (interaction groups) with strong relationships between individual elements a more complex assessment will usually be required.

One of the main issues associated with using this method is that often there are not 'typical' ecosystems occurring within the study area which can be easily classified according to the defined categories. In addition, the method does not quantify the extent of the impacts arising from the interactions which would cause difficulties in determining the significance of the impacts. It also does not allow for the differentiation between indirect effects and interactions.

Network analysis and a matrix were used for this project to assist in determining the potential impacts. The assessment of the interactions and indirect impacts provided a more complete understanding of the impacts associated with the route options, and therefore enabled the comparison of the options to be based on more comprehensive information. The methodology did however, in this case, result in the developer incurring further costs from the more detailed level of assessment undertaken.

The mapping of the ecosystem types and the predicted extent of the associated interactions, together with the use of the overlay of the options provided a clear visual presentation of the likely spatial impacts.

Spatial Analysis and Network Analysis of Ecosystem Interactions

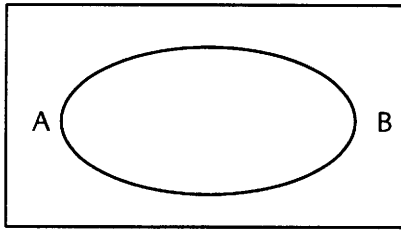

1. Define the study area for the assessment.

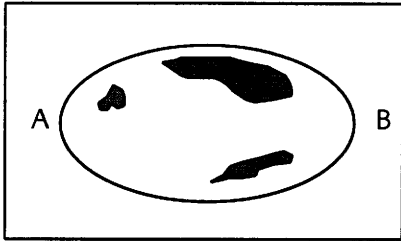

2. Undertake baseline surveys and consultations
Determine sensitive areas and ecosystem type
within the study area.

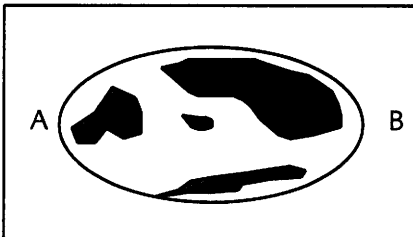

3. Carryout network analysis for ecosystem types
and refine the extent of the sensitive areas.

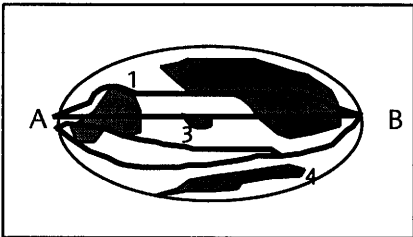

4. Overlay route options onto the study area. Assess
impacts of options.

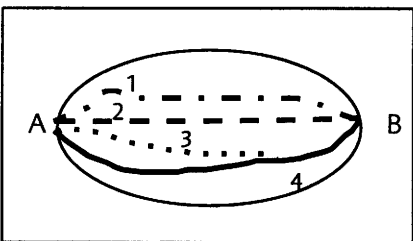

5. Determine the route option with the least
environmental impacts on the sensitive areas
i.e. Route 4.

Adapted from Sporbeck et al.

CASE STUDY I- KILLINGHOLME CCGT POWER STATION EXTENSION, UNITED KINGDOM

Methods Used: Modelling, Threshold Analysis

Background to the Project

The Environmental Statement was prepared to assess the effects of constructing an extension to the existing Combined Cycle Gas Turbine (CCGT) Power station at Killingholme, Humberside. The extension, once built, would occupy an area of approximately 7 hectares, and would be located on land currently used for landscaping for the existing power station. The site lies on the south bank of the Humber Estuary, parts of which are designated as a Site of Special Scientific Interest (SSSI), within an area surrounded mainly by heavy industrial uses and power generation works. The nearest population concentrations lie some 5km to the south and west of the power station site.

The Environmental Statement was required under the Electricity and Pipeline Works (Assessment of Environmental Effects) Regulations 1989 (section 36), and submitted to the Secretary of State for Trade and Industry, together with the application for the power station, for approval.

A large amount of the infrastructure which serves the existing power station would be utilised for the extension, including the access road, cooling water pipe, fuel infrastructure and transmission lines. The existing sub-station, which provides the connections into the National Grid, would be extended.

Overview of the Methodologies

PowerGen, the scheme developer, co-ordinated the Environmental Statement and specialist sub-consultants were used where required. Key impacts were therefore identified using PowerGen's previous experience of constructing and operating similar plant, in particular the existing power station on the site, and from a scoping and consultation exercise.

Although no formal Scoping Report was prepared for the scheme, a comprehensive consultation exercise was carried out with a number of statutory and non statutory organisations. Scoping meetings were held with the local planning authority (Development Control and Environmental Health), Her Majesty's Inspectorate of Pollution (emissions), National Rivers Authority (water/environment), English Nature (nature conservation) and the Lincolnshire Trust for Nature Conservation (regional/ local nature conservation sites).

The consultation meetings confirmed the potential indirect and cumulative impacts, as well as impact interactions which had been identified and were proposed to be assessed by PowerGen.

Indirect and cumulative impacts and impact interactions were identified within a number of chapters of the Environmental Statement and discussed and incorporated within the overall assessment of the effect on the receptor (e.g. air quality, ecology, noise etc.).

Although not produced in the Environmental Statement, the following table has been compiled to show in a summarised form the type of impacts that were identified and how they were addressed within the Environmental Statement.

Table 1 - Potential Indirect and Cumulative Impacts and Impact Interactions Identified

Impact	Comment
Effects of salt deposition on vegetation.	Identified as an issue from the previous assessment of the existing power station. Addressed in the ES. Modelling to identify the range and level of deposition of salt carried out. Consultees identified potentially vulnerable habitats close to the proposed extension.
Effects of Nitrogen deposition on habitats.	As above.
Impact on local economy from increased use of local services, accommodation and plant hire.	Addressed briefly in the ES.
Combined noise generated by the existing and proposed power station.	Identified as an issue through consultation. Existing PowerGen power station and National Power power station were already subject to a combined noise limit of 44 _{L10} dB(A). The cumulative noise impact was assessed based on calculations and an appropriate noise condition was discussed and agreed with the local planning authority.
Salt deposition of the proposed development together with that from the emissions from the existing cooling towers.	Identified as part of scoping and also requested by consultees. Used VISPACT model to predict rate of dispersion.
Predicted relative increase in concentrations of NO _x and SO ₂ of the combined emissions from the adjacent power stations and the proposed extension.	Identified at scoping stage as potential issue, based on previous experience. Assessed within the ES and used modelling to predict the dispersion of the emissions
Reaction of emissions with the atmosphere to generate low-level ozone.	Identified as a potential issue at scoping stage, based on previous experience. Detailed assessment was not undertaken in the ES.

Detailed examples of indirect and cumulative impacts identified within the power station study area, are given below:

Example 1: Indirect and Cumulative Impact - Salt Dispersion and Deposition on Vegetation

Collection of Baseline Data

Emissions from cooling towers include saline carry-over droplets, which will have the approximate composition of the estuarine water that is used in the cooling process. Chase Hill Wood, to the east of the existing power station is an oak woodland but designated as a Site of Nature Conservation Interest due to the colony of purple orchids which it supports.

Meetings with consultees identified the issue of potential impacts on sensitive vegetation, particularly within Chase Hill Wood. The effects of salt deposition on planting and vegetation within the existing power station site was also investigated. The impacts of salt dispersion and deposition from both the proposed extension and the cooling towers from the existing power station were assessed together.

Baseline surveys investigated the condition of existing and newly planted trees in Chase Hill Wood and the adjacent Fox Covert and indicated that the trees were stressed, with poor growth, die back and death. However the assessment concluded that this was consistent with the lack of management and overcrowding rather than through salt deposition from the existing cooling towers. The trees within the adjacent Fox Covert, where the woodland is managed, were noticeably more healthy even though subject to comparable rates of saline deposition.

Assessment and Reporting of Impacts

The Environmental Assessment utilised the baseline survey data and investigation of tree growth to predict environmental impacts resulting from the current power stations and in addition, the proposed extension. The assessment concluded that vegetation within the existing site showed good rates of establishment, despite being within a zone which was currently experiencing salt deposition. Furthermore, young trees which are particularly susceptible to the effects of salt deposition, showed good rates of establishment.

The computer model VISPACT was used to assess distance that the saline water plume was carried. This model predicted the frequency with which a water plume would form and also the frequency with which the plume may touch the ground (ground fogging), and therefore cause salt deposition. The Environmental Statement reported that the results showed that deposition levels of the combined emissions from the existing and proposed extension would not increase over current baseline conditions. The results were

illustrated on a contour map. The assessment also used PowerGen's operational experience in concluding that ground fogging was not found to occur more than a few hundred metres from low-level towers.

The effects of the proposed cooling towers were found to slightly increase the salt deposition to some extent but that the rates would not be raised above the highest currently occurring in the area. The effects on vegetation were therefore taken to be negligible. No noticeable effects on the salinity of the soil would be expected from the forecast deposition rates, and therefore no adverse impacts were predicted on the colony of purple orchids.

Example 2: Cumulative Impact - Predicted Relative Increase in Concentrations of NO_x and SO₂

Collection of Baseline Data

To fulfil the requirements of the Integrated Pollution Prevention Control application, and the Environmental Assessment Regulations, the effects of NO_x and SO₂ emissions were assessed. The assessment undertaken was based on Guideline and Limit concentrations for nitrogen dioxide and sulphur dioxide which have been set in EC Directives 85/203/EEC and 80/779/EEC, and implemented in the UK through the Air Quality Regulations 1989. Situated next to the existing PowerGen power station there is a second similar plant operated by National Power.

The assessment utilised existing air quality data collected and held by both PowerGen and National Power to establish background levels of NO_x and SO₂. The baseline data therefore included the emissions from the existing power stations in the immediate vicinity of the proposed development.

Assessment and Reporting of Impacts

A computer model, the UK-ADMS (United Kingdom - Advanced Dispersion Modelling System), was used to predict the concentrations of nitrogen dioxide and sulphur dioxide at ground level as a result of the operation of the proposed plant extension. As part of the assessment additional model runs were carried out for the two existing power stations so that the relative increase in NO₂ and SO₂ could be determined. The model took account of local weather conditions and geography, and was also run to determine the dispersion during specific meteorological conditions.

The predicted increase in concentrations and dispersion of NO_x and SO₂ were found to be within the guideline values, even when taking into account the cumulative effects of the emissions from the proposed extension and the two existing power stations.

Example 3: Impact Interactions - Generation of Ozone

Collection of Baseline Data

The potential to increase low level ozone as a result of the proposed power station extension was identified at the scoping stage. It is possible to generate low-level ozone through a series of complex reactions with sunlight, trace hydrocarbons and nitrogen oxides. Low-level ozone can cause adverse health effects when present at ground level. The proposed extension to the power station would emit nitrogen oxides.

Monitoring of the levels of low-level ozone had been carried over a number of years at nearby power station sites. The existing concentrations at the site were categorised as good or very good, based on Department of Environment guidelines, and were well within acceptable limits.

Assessment and Reporting of Impacts

The assessment took into account the existing low-level ozone concentrations at the site, and also considered detailed research on the chemical reactions involving combustion products from power stations and low-level ozone. Operational experience and expert opinion were used in the assessment. This concluded that the combustion gases would be diluted to levels undetectable above background over short distances. There would therefore not be any increase in the concentration of low-level ozone attributable to the power station extension.

Evaluation of the Methodologies Used and Implications to the Project

The VISPACT model which was used to assess the indirect and cumulative impacts associated with salt dispersion and deposition on vegetation was the best available at the time of the assessment. However, the author of the Environmental Statement expressed concerns that the model, although a useful predictive technique, can be over pessimistic in predictions when compared with operational experience.

The UK-ADMS computer modelling assessment used to assess the cumulative impact of relative increases in concentrations of NO_x and SO₂ took account of the additional contribution that the proposed extension would make compared with the existing power stations. The model assumed that the existing stations would emit NO_x at their consent limits, and therefore provided predictions that were pessimistic. Again the model used is a useful predictive technique and was at the time of the assessment considered to provide the most accurate predictions of emissions and dispersion. However, the potential for over pessimistic results should be given consideration in assessing cumulative impacts, for instance from a number of similar developments.

The assessment of impact interactions to generate ozone was based on operational experience and research into similar operations.

PowerGen commented that, as the developer and co-ordinating author of the Environmental Statement, the need to address indirect and cumulative impacts and impact interactions was identified by specialists within the project team through an informal Scoping process. These issues and the suggested approach to the assessment were then discussed and agreed in meetings with statutory and non statutory consultees.

Although assessment on indirect and cumulative impacts and impact interactions required additional baseline data, this was readily available as a result of continual monitoring of the existing power stations in the area and operational experience. Similarly the need for additional modelling runs had been considered and allowed for during the Scoping stage. The implications to the resourcing and programme of the project were not considered to be significant as these issues had been identified and allowed for at the start of the project.

CASE STUDY J - RETHIMNO CITY WASTE WATER TREATMENT WORKS, GREECE

Method Used: Modelling, Checklists, Consultations and Expert Opinion

Background to the Project

An Environmental Statement was prepared for a new Waste Water Treatment Works (WWTW) and outfall close to the town of Rethimno, on the island of Crete. The works would treat a population equivalent of 60,000 with a design population of 90,000 (summer 2028). Prior to construction of the works, waste water was discharged untreated to the foreshore.

The town of Rethimno is a popular tourist area and the WWTW would be constructed to meet the standards of the Urban Waste Water Treatment Directive (91/271/EEC).

The Environmental Statement for the WWTW included assessment of a new buried 500m outfall, and a new sewerage system (pipelines and pumping stations) to transfer waste water to the new works. The key impacts identified related to the marine environment due to the nature of the development and importance of the area for tourism.

Prior to the production of the Environmental Statement, an alternative site assessment had been undertaken which involved detailed Environmental Assessment of three site options.

Overview of the Methodology

The Environmental Statement was undertaken by a team of in-house and specialist sub consultants, co-ordinated by a project leader.

Although no formal Scoping Report was prepared for the scheme, the project team consulted with the authorities and statutory bodies on commencement of the project.

The extensive experience of the project team in carrying out Environmental Assessments of previous WWTW was used to identify the potential for indirect and cumulative impacts.

Site visits and consultations were used to collect baseline data from the authorities, taking into consideration the indirect and cumulative impacts. The study area was defined by existing and proposed conditions. As the key

impacts were identified as marine issues, the data collection was focused primarily on this.

The project utilised checklists and consultations to identify and assess potential indirect and cumulative impacts, as well as impact interactions. The checklists employed in the study were dictated by Greek legislation. These checklists are generic examples for sewage treatment works. Public participation was also a significant part of the project.

The Environmental Statement took into consideration planned developments when carrying out the impact assessments. In this case there were proposals to develop on one side of the town and the assessment of the project therefore considered its potential impacts on this proposed development.

Although not produced in the Environmental Statement, the following table has been compiled to show in a summarised form examples of the type of indirect and cumulative impacts that were identified and how they were addressed in the Environmental Statement.

Table 1 Types of Potential Cumulative and Indirect Impacts Identified

Impact	Comment
Effect of existing discharges and impact of the discharge from the WWTW	During initial investigations and site visits the project team identified existing discharges from a tannery and abattoir close to the site. This impact was addressed in design of the scheme and in the Environmental Statement using modelling.
Associated sewerage network to transfer flows to the new WWTW	The impact from ancillary developments was identified at the commencement of the project. Impacts were addressed in the Environmental Statement.

Detailed examples of indirect and cumulative impacts identified within the Rethimno City WWTW are outlined below:

Example 1: Cumulative Impact - Discharges from Tannery and Abattoir

Collection of Baseline Data

Site investigations and data collection during the early stages of the project identified existing sources of discharge. These included a tannery and an abattoir. Discharges from these two operations were significant in terms of the quality of the effluent.

The project team identified that treatment of the tannery and abattoir effluent would need to be addressed in the design of the WWTW. With provision of pre-treatment on site, the effluent could be transferred to the new WWTW for

treatment and disposal through the new outfall. This would have the advantage of allowing greater control of the combined discharges from both operations.

In conjunction with the proposed design philosophy, the project team identified the need to address the impacts associated with this in the Environmental Statement.

Collection of baseline data also contributed to the development of a coastal model to provide information on the dispersive processes in the vicinity of the proposed outfall and its effect on the local beaches.

Assessment and Reporting of Impacts

The Environmental Assessment used a computer model to predict the impact of the discharge on the local beaches under various conditions. The model took into consideration the impact of pre-treatment at the abattoir and tannery, with transfer of waste from these sites for treatment and discharge at the new WWTW site. The model was used to compare the current discharges to the proposed future situation with the new WWTW.

Example 2: Indirect Impact - Provision of a Sewerage Network

Collection of Baseline Data

A new sewerage network would be required to transfer flows from the existing crude discharges, the tannery and the abattoir to the new WWTW. Due to the location and elevation of the works, pumping stations would also be required.

The Environmental Statement took into consideration impacts resulting from these ancillary activities associated with the scheme. The need to assess such impacts was therefore considered during data collection.

Assessment and Reporting of Impacts

Assessment of these ancillary developments included the potential for odour generation from one of the pumping stations that was located in an urban amenity area.

The assessment also addressed the new pipelines that would be required to transfer effluent from the tannery and the abattoir to the WWTW site. This addressed the visual impact and routing of the pipeline, and as a result this was constructed below ground level.

Evaluation of the Methodology Used and Implications to the Project

The identification and assessment of impacts was based on the previous experience of the project co-ordinator and the project team. Where potential

cumulative and indirect impacts had been identified by the team, these were assessed using both modelling techniques and expert opinion.

The requirement to assess the indirect and cumulative impacts was considered at the commencement of the project and the project co-ordinator therefore concluded that the implications to resourcing and programming of the project were not significant.

ABBREVIATIONS

CCGT	Combined Cycle Gas Turbine
dB	Decibel
EIA	Environmental Impact Assessment
ES	Environmental Statement
GIS	Geographical Information System
ha	Hectare
NO _x	Nitrogen oxide
SAC	Special Area of Conservation
SEA	Strategic Environmental Assessment
SO ₂	Sulphur dioxide
SPA	Special Protection Area
UK	United Kingdom
WWTW	Waste Water Treatment Works

GLOSSARY

Ancillary Development	Additional development related to a particular project, particularly referring to services which supply it.
Annex I Project	Directive 85/337. Annex I includes projects likely to result in significant environmental impacts. e.g. crude oil refineries, thermal power stations, motorways, integrated chemical installations, ports and inland waterways and incinerators. An Environmental Statement is compulsory for these projects.
Annex II Project	Refers to the status of a project with respect to EC Directive 85/337. Whether an ES should be provided for a particular project is at the discretion of the relevant authority.
Baseline Studies	Studies of existing environmental conditions which are designed to establish the baseline conditions against which any future changes can be measured or predicted.
Carrying Capacity	An imprecise term which can mean a number of different things in different contexts. It can refer to the population of humans or animals which can be supported by a given environment. Alternatively, it could refer to the capacity of the environment to tolerate stress or pollution.
Ecosystem	A community of interdependent plants and animals together with the environment which they inhabit and with which they interact.
Environmental Impact Assessment (EIA)	A process by which information about the environmental impacts of a project are collected, both by the developer and from other sources, and taken into account by the relevant decision making body before a decision is given on whether the development should proceed.
Environmental Statement	A document which sets out the assessment of the likely effects of the project on the environment.
Geographical Information System	A computerised data system that stores, retrieves, manipulates and displays

(GIS)	spatial/environmental information.
Indicators/Indices	A means by which various thresholds are translated into measurable terms. They help describe environmental quality and allow the measurement of progress.
Mitigation	Any process, activity or design to avoid, reduce or remedy adverse environmental impacts likely to be caused by a development project.
Monitoring	A combination of observation and measurement of a development , which is aimed at detecting new development trends; at maintaining an ongoing check on performance or compliance with laws/conditions; or providing a warning of changes that might affect a development.
Receptor/Sensitive Receptor	A component of the natural or man made environment such as water, air, a building, or a plant that is potentially affected by an impact.
Scoping	An initial stage in determining the nature and potential scale of the environmental impacts arising from the proposed development, and assessing what further studies are required to establish their significance.
Strategic Environmental Assessment (SEA)	The formalised, systematic and comprehensive process of evaluating the environmental effects of a policy, plan or programme.
Sustainable Development	Development which fulfils the resource needs of the current generation, without compromising the needs of future generations. It is an imprecise term, but can be taken as meaning development that promotes economic, social and environmental benefits in the long term.
Threshold	The point after which an environment, organism, society or economy is clearly affected and degrades. Ideally, the assessment should prevent any impacts arising from a development from causing established thresholds to be reached or exceeded.

BIBLIOGRAPHY

Barrow, C. J. (1997). *Environmental and Social Impact Assessment*. London: Arnold.

Burris, R. K, and Canter, L. W. (1997). Facilitating Cumulative Impact Assessment in the EIA Process. *International Journal of Environmental Studies*. **53**, 11-29.

Davies, K. (1992). *An Advisory Guide on Addressing Cumulative Environmental Effects under the Canadian Environmental Assessment Act: A Discussion Paper*. Final Draft. Prepared for the Federal environmental Assessment Review Office.

Department of the Environment - Planning Research Programme. (1995). *Preparation of Environmental Statements for Planning Projects that Require Environmental Assessment - A Good Practice Guide*. London: HMSO

Glasson, J., Therivel, R, and Chadwick, A. (1994). *Introduction to Environmental Impact Assessment*. London: UCL Press.

Julien, B. Fenves, S. J. and Small, M. (1992). An Environmental Impact Identification System. *Journal of Environmental Management*. **36**, 167-184.

Smit, B. and Spaling, H. (1995). Methods for Cumulative Effects Assessment. *Environmental Impact Assessment Review*. **15** (1), 81-106.

Southerland, M. T. (1995). Methods, Techniques, and Tools for Analyzing Cumulative Effects. *National Association of Environmental Professionals. Environmental Challenges: The Next 20 Years, NAEP 20th Annual Conference Proceedings*, Washington DC. 874-896.

US Council on Environmental Quality. (1997). *Considering Cumulative Effects under the National Environmental Policy Act*. US Executive Office of the President.

Assessment of indirect and cumulative impacts as well as impact interactions

Volume 3: Guidelines

Luxembourg: Office for Official Publications of the European Communities

2000 — 179 pp. — 21 x 29.7 cm

Volume 3: ISBN 92-828-8047-8

Volumes 1–3: ISBN 92-828-8048-6

Price (excluding VAT) in Luxembourg: Volume 3: EUR 25

Volumes 1–3: EUR 57.50

Venta • Saig • Verkauf • Πωλησεις • Sales • Vente • Vendita • Verkoop • Venda • Myynti • Försäljning

BELGIQUE/BELGIE

Jean De Lannoy
Avenue du Roi 202/Koningslaan 202
B-1190 Bruxelles/Brussel
Tel (32-2) 538 43 08
Fax (32-2) 538 08 41
E-mail jean.de.lannoy@infoboard.be
URL: <http://www.jean-de-lannoy.be>

La librairie européenne/De Europese Boekhandel
Rue de la Loi 244/Wetstraat 244
B-1040 Bruxelles/Brussel
Tel. (32-2) 295 26 39
Fax (32-2) 735 08 60
E-mail mail@libeurop.be
URL: <http://www.libeurop.be>

Montieur belge/Belgisch Staatsblad
Rue de Louvain 40-42/Leuvenseweg 40-42
B-1000 Bruxelles/Brussel
Tel (32-2) 552 22 11
Fax (32-2) 511 01 84

DANMARK

J. H. Schultz Information A/S
Herstedevang 12
DK-2620 Albertslund
Tel (45) 43 63 23 00
Fax (45) 43 63 19 69
E-mail schultz@schultz.dk
URL: <http://www.schultz.dk>

DEUTSCHLAND

Bundesanzeiger Verlag GmbH
Vertreibsabteilung
Amsterdamer Straße 192
D-50735 Köln
Tel (49-221) 97 66 80
Fax (49-221) 97 66 82 78
E-Mail vertreib@bundesanzeiger.de
URL: <http://www.bundesanzeiger.de>

ΕΛΛΑΔΑ/GREECE

G. C. Eleftheroudakis SA
International Bookstore
Panepistimiou 17
GR-10564 Athina
Tel (30-1) 531 41 80/1/2/3/4/5
Fax (30-1) 323 98 21
E-mail elebooks@netor.gr

ESPAÑA

Boletín Oficial del Estado
Tratado, 27
E-28017 Madrid
Tel (34) 915 38 21 11 (Libros),
913 84 17 15 (Suscrip)
Fax (34) 915 38 21 21 (Libros),
913 84 17 14 (Suscrip)
E-mail clientes@com.boe.es
URL: <http://www.boe.es>

Mundi Prensa Libros, SA

Castello, 37
E-28001 Madrid
Tel (34) 914 36 37 00
Fax (34) 915 75 38 98
E-mail: libros@mundiprensa.es
URL: <http://www.mundiprensa.com>

FRANCE

Journal officiel
Service des publications des CE
28, rue Drouot
F-75727 Paris Cedex 15
Tel (33) 140 58 77 31
Fax (33) 140 58 77 00
E-mail: europublications@journal-officiel.gouv.fr
URL: <http://www.journal-officiel.gouv.fr>

IRELAND

Government Supplies Agency
Publications Section
4-5 Harcourt Road
Dublin 2
Tel (353-1) 661 31 11
Fax (353-1) 475 27 60
E-mail opw@iol.ie

ITALIA

Licosa SpA
Via Duca di Calabria, 1/1
Casella postale 552
I-50125 Firenze
Tel (39) 055 64 83 1
Fax (39) 055 64 12 57
E-mail licosa@licosa.com
URL: <http://www.licosa.com>

LUXEMBOURG

Messagerie du livre SARL
5, rue Raiffesen
L-2411 Luxembourg
Tel. (352) 40 10 20
Fax (352) 40 06 61
E-mail mail@mdl.lu
URL: <http://www.mdl.lu>

NEDERLAND

SDU Servicecentrum Uitgevers
Christoffel Plantijnstraat 2
Postbus 20014
2500 EA Den Haag
Tel (31-70) 378 98 80
Fax (31-70) 378 97 83
E-mail, sdu@sdul.nl
URL: <http://www.sdu.nl>

ÖSTERREICH

**Manz'sche Verlags- und
Universitätsbuchhandlung GmbH**
Kohlmarkt 16
A-1014 Wien
Tel (43-1) 53 16 11 00
Fax (43-1) 53 16 11 67
E-Mail bsstellen@manz.co.at
URL: <http://www.manz.at>

PORTUGAL

Distribuidora de Livros Bertrand Ld.ª
Grupo Bertrand, SA
Rua das Terras dos Vales, 4-A
Apartado 60037
P-2700 Amadora
Tel (351) 214 95 87 87
Fax (351) 214 96 02 55
E-mail dlo@bp.pt

Imprensa Nacional-Casa da Moeda, SA
Rua da Escola Politécnica nº 135
P-1250-100 Lisboa Codex
Tel (351) 213 94 57 00
Fax (351) 213 94 57 50
E-mail: spoc@icnm.pt
URL: <http://www.icnm.pt>

SUOMI/FINLAND

**Akateeminen Kirjakauppa/
Akademiska Bokhandeln**
Keskuskatu 1/Centraigatan 1
PL/PS 128
FIN-00101 Helsinki/Helsingfors
P/fn (358-9) 121 44 18
F/fax (358-9) 121 44 35
Sähköposti: sp@akateeminen.com
URL: <http://www.akateeminen.com>

SVERIGE

BTJ AB

Traktorvägen 11
S-221 82 Lund
Tel (46-46) 19 00 00
Fax (46-46) 30 79 47
E-post: bju-pub@btj.se
URL: <http://www.btj.se>

UNITED KINGDOM

The Stationery Office Ltd
Orders Department
PO Box 276
London SW8 5DT
Tel (44-171) 870 80 05-522
Fax (44-171) 870 80 05-533
E-mail: book.orders@theso.co.uk
URL: <http://www.tsonline.co.uk>

ISLAND

Bokabud Larusar Blondal
Skólavordustig, 2
IS-101 Reykjavik
Tel (354) 552 55 40
Fax (354) 552 55 60
E-mail bokabud@smnet.is

NORGE

Swets Norge AS

Ostenjoveien 18
Boks 6512 Etterstad
N-0606 Oslo
Tel (47-22) 97 45 00
Fax (47-22) 97 45 45
E-mail: kytnerid@swets.nl

SCHWEIZ/SUISSE/SVIZZERA

Euro Info Center Schweiz
c/o OSEC
Stampfenbachstraße 85
PF 492
CH-8035 Zurich
Tel (41-1) 365 53 15
Fax (41-1) 365 54 11
E-mail: eca@osec.ch
URL: <http://www.osec.ch/secs>

BÁLGARÍA

Europress Euromedia Ltd
59, blvd Vitosha
BG-1000 Sofia
Tel (359-2) 980 37 66
Fax (359-2) 980 42 30
E-mail: Milena@mbox.cit.bg

ČESKÁ REPUBLIKA

ÚSIS

NIS-prodejna
Havekova 22
CZ-130 00 Praha 3
Tel (420-2) 24 23 14 86
Fax (420-2) 24 23 11 14
E-mail: vojanova@usiscr.cz
URL: <http://usiscr.cz>

CYPRUS

**Cyprus Chamber of Commerce
and Industry**
PO Box 1455
CY-1500 Nicosia
Tel (357-2) 66 95 00
Fax (357-2) 66 10 44
E-mail: demetrap@ccc.org.cy

ESTI

Eesti Kaubandus-Tootuskoda
(Estonian Chamber of Commerce and Industry)
Toom-Kooli 17
EE-0001 Tallinn
Tel (372) 646 02 44
Fax (372) 646 02 45
E-mail: emto@koda.ee
URL: <http://www.koda.ee>

HRVATSKA

MediTrade Ltd

HR-10000 Zagreb
Tel (385-1) 481 94 11
Fax (385-1) 481 94 11

MAGYARORSZÁG

Euro Info Service

Hungexpo Európa Ház
PO Box 44
H-1441 Budapest
Tel (36-1) 264 82 70
Fax (36-1) 264 82 75
E-mail: euromio@euromio.hu
URL: <http://www.euromio.hu>

MALTA

Miller Distributors Ltd

Malta International Airport
PO Box 25
Luqa LQA 05
Tel (356) 66 44 88
Fax (356) 67 67 99
E-mail: qwrth@usa.net

POLSKA

Ars Polona

Krakowskie Przedmiescie 7
Skw pocztowa 1001
PL-00-950 Warszawa
Tel (48-22) 826 12 01
Fax (48-22) 826 92 40
E-mail: books119@arspolona.com.pl

ROMÂNIA

Euromedia

Strada Franceza Nr 44 sector 3
RO-70749 Bucuresti
Tel (40-1) 315 44 03
Fax (40-1) 315 44 03
E-mail: mnedelcu@pcnet.pcn.ro

ROSSIYA

CCEC

60-Ietuya Oktyabrya Av 9
117132 Moscow
Tel (7-095) 135 52 27
Fax (7-095) 135 52 27

SLOVAKIA

Centrum VTI SR

Nám Slobody, 19
SK-81223 Bratislava
Tel (421-7) 54 41 83 64
Fax (421-7) 54 41 83 64
E-mail: europ@vti.sk
URL: <http://www.silk.stuba.sk>

SLOVENIJA

Gospodarski Vestnik

Dunajska cesta 5
SLO-1000 Ljubljana
Tel (386) 613 09 16 40
Fax (386) 613 09 16 45
E-mail: europ@gvestnik.si
URL: <http://www.gvestnik.si>

TURKIYE

Dunya Infotel AS

100, Yil Mahallesi 34440
TR-80050 Bagcilar-Istanbul
Tel (90-212) 829 46 89
Fax (90-212) 829 46 27
E-mail: infotel@dunya-gazete.com.tr

AUSTRALIA

Hunter Publications

PO Box 404
3067 Abbotsford, Victoria
Tel (61-3) 94 17 53 61
Fax (61-3) 94 19 71 54
E-mail: pdavies@ozemail.com.au

CANADA

Les Éditions La Liberté Inc.

3020, chemin Sainte-Foy
G1X 3V6 Sainte-Foy, Québec
Tel (1-418) 658 37 63
Fax (1-800) 567 54 49
E-mail: liberte@mediom.qc.ca

Renouf Publishing Co. Ltd

5369 Chemin Canotek Road Unit 1
K1J 9J3 Ottawa, Ontario
Tel (1-613) 745 26 65
Fax (1-613) 745 76 60
E-mail: order.dept@renoufbooks.com
URL: <http://www.renoufbooks.com>

EGYPT

The Middle East Observer

41 Shenf Street
Cairo
Tel (20-2) 392 69 19
Fax (20-2) 393 97 32
E-mail: inquiry@meobserver.com
URL: <http://www.meobserver.com>

INDIA

EBIC India

3rd Floor, Y. B Chavan Centre
Gen J Bhosale Marg
400 021 Mumbai
Tel (91-22) 282 60 64
Fax (91-22) 285 45 64
E-mail: ebic@gasbm01.vsnl.net.in
URL: <http://www.ebicindia.com>

JAPAN

PSI-Japan

Asahi Sanbancho Plaza #206
7-1 Sanbancho, Chiyoda-ku
Tokyo 102
Tel (81-3) 32 34 69 21
Fax (81-3) 32 34 69 15
E-mail: books@psi-japan.co.jp
URL: <http://www.psi-japan.co.jp>

MALAYSIA

EBIC Malaysia

Level 7, Wisma Hong Leong
18 Jalan Perak
50450 Kuala Lumpur
Tel (60-3) 21 62 62 98
Fax (60-3) 21 62 61 98
E-mail: ebic-kl@mol.net.my

MÉXICO

Mundi Prensa Mexico, SA de CV

Río Pánuco No 141
Colonia Cuauhtémoc
MX-06500 Mexico, DF
Tel (52-5) 533 56 58
Fax (52-5) 514 67 98
E-mail: 1015452361@compuserve.com

PHILIPPINES

EBIC Philippines

19th Floor, PS Bank Tower
Sen Gil J Puyat Ave cor Tindalo St.
Makati City
Metro Manila
Tel (63-2) 759 66 80
Fax (63-2) 759 66 90
E-mail: ecppcom@globe.com.ph
URL: <http://www.ecpp.com>

SOUTH AFRICA

Eurochamber of Commerce in South Africa

PO Box 781738
2146 Sandton
Tel (27-11) 884 39 52
Fax (27-11) 883 55 73
E-mail: info@eurochamber.co.za

SOUTH KOREA

The European Union Chamber

of Commerce in Korea
5th Fl., The Shilla Hotel
202, Jangchung-dong 2 Ga, Chung-ku
100-392 Seoul
Tel (82-2) 22 53-5631/4
Fax (82-2) 22 53-5635/6
E-mail: euccok@euccok.org
URL: <http://www.euccok.org>

SRI LANKA

EBIC Sri Lanka

Trans Asa Hotel
115 Sri chittampalam
A. Gardiner Mawatha
Colombo 2
Tel (94-1) 074 71 50 78
Fax (94-1) 44 87 79
E-mail: ebicsl@trm.com

THAILAND

EBIC Thailand

29 Vessava Building, 8th Floor
Sri Chulom
Ploenchit
10330 Bangkok
Tel (66-2) 653 06 27
Fax (66-2) 655 06 28
E-mail: ebicthk@ksc15.th.com
URL: <http://www.ebicthk.org>

UNITED STATES OF AMERICA

Bernan Associates

4611-F Assembly Drive
Lanham MD20706
Tel (1-800) 274 44 47 (toll free telephone)
Tel (1-800) 865 34 50 (toll free fax)
E-mail: query@bernan.com
URL: <http://www.bernan.com>

ANDERE LANDER/OTHER COUNTRIES/
AUTRES PAYS

**Bitte wenden Sie sich an ein Büro Ihrer
Wahl/ Please contact the sales office
of your choice/ Veuillez vous adresser
au bureau de venue de votre choix**
Office for Official Publications
of the European Communities
2, rue Mercier
L-2985 Luxembourg
Tel (352) 29 29-4265
Fax (352) 29 29-42758
E-mail: info@cec.eu.int
URL: <http://eur-pp.eu.int>

Price (excluding VAT) in Luxembourg: EUR 25 (Vol. 3)
EUR 57.50 (Vols 1-3)

ISBN 92-828-8047-8



OFFICE FOR OFFICIAL PUBLICATIONS
OF THE EUROPEAN COMMUNITIES

L-2985 Luxembourg

