



Commission of the European Communities

energy

**BASIC CHARACTERISTICS FOR LOW-COST
HOUSES IN ORDER TO REDUCE
THE ENERGY CONSUMPTION FOR HEATING**



Report
EUR 10285 EN

Blow-up from microfiche original

Commission of the European Communities

energy

**BASIC CHARACTERISTICS FOR LOW-COST
HOUSES IN ORDER TO REDUCE
THE ENERGY CONSUMPTION FOR HEATING**

A. DUPAGNE
UNIVERSITE DE LIEGE
Laboratoire de Physique du Bâtiment
Avenue des Tilleuls, 15
B-4000 LIEGE (BELGIQUE)

Contract No. EEA-5-060-B(G)

SYNTHESIS REPORT

Directorate-General Science, Research and Development

1985

EUR 10285 EN

Published by the
COMMISSION OF THE EUROPEAN COMMUNITIES

**Directorate-General
Information Market and Innovation**

**Bâtiment Jean Monnet
LUXEMBOURG**

LEGAL NOTICE

Neither the Commission of the European Communities nor any person acting on behalf of the Commission is responsible for the use which might be made of the following information

SUMMARY

In collaboration with CSTC, Belgium, TNO, Netherlands and BRE, UK a practical energy saving design methodology, based on a steady state simulation model for the behaviour of houses (LPB 3-4) has been developed in the First Energy Conservation R + D Programme (1975 - 1979). This methodology has been used for the design and construction of eight houses. The aim of this project was to validate the existing steady state model and to improve the design methodology by including simulation of the dynamic thermal behaviour of buildings (LPB 5) and by developing a conversational computerized version of the design guidelines. Also the investment, operating and maintenance cost has been included.

After detailed design and construction, measurements have been carried out in five of the eight houses. In this monitoring project the measuring methodology was given priority. Simultaneously the design methodology has been computerized and is now available in the form of a users guide.

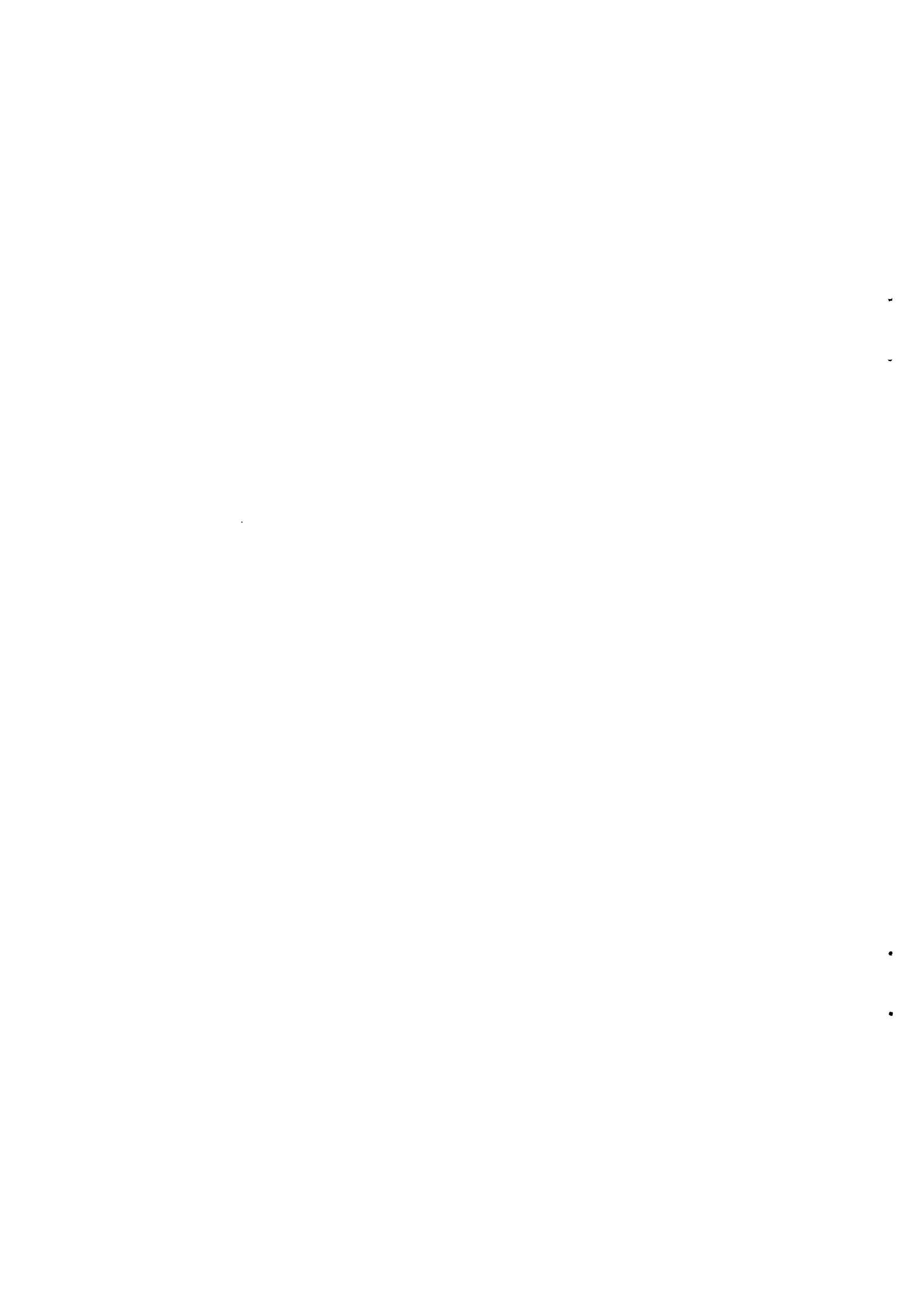

TABLE OF CONTENTS

Foreword

1.	Description of the design process used during the application stage of the research work	1.
	1.1. Data collection	1.
	1.2. Site analysis and settlement layout	1.
	1.3. Feasibility study of the project and outline proposals	2.
	1.4. Detailed fenestration	6.
	1.5. Detailed design	11.
2.	Building of the houses and superintendence	14.
3.	Completion energy inspection of the houses	15.
4.	Monitoring of the Marchin houses	17.
	4.1. Main aspects of the Marchin monitoring	17.
	4.2. Measurement system	18.
	4.3. Measurements	19.
5.	Computerization of the design methodology	21.
6.	Analytical tools	27.
	6.1. Dynamic modelling	28.
	6.2. Degree-day methodology	31.
	6.3. Shading evaluation	42.
7.	Content description of the whole final report	48

1. DESCRIPTION OF THE DESIGN PROCESS USED DURING THE APPLICATION STAGE OF THE RESEARCH WORK

A first research work carried out for the Commission of the European Communities has produced a manual design methodology [1]. Mainly orientated to the conception of low-cost houses, it integrates some fundamental thermal concepts into the design process. The present research work had for target to apply this design method to an actual case, in order to test the practicability of the method, to bring its lacunas to the light and to confront the theoretical estimations of heating energy needs, with actual measurements. The recommended design process has been followed along the conception of 25 houses, among which five have been built.

1.1. Data collection

The work first concerned the collection of any pertinent information necessary to any author of an architectural project, having the Belgian National Housing Society as a client; contacts had been established with the town authorities where the houses would be built, and with the regional and national housing societies.

1.2. Site analysis and settlement layout

Located at about 1.5 km from the centre of Marchin and 10 km from the city of Huy, the site rises with a mean slope of 16% and is orientated North-North-West. This actual site is difficult (but cheap) and the application of the design methodology lets hope to obtain energetic results better than those obtained with plans usually proposed to the Belgian National Housing Society for such a type of site. This badly orientated site offered a good opportunity to devote some intellectual investment in the site analysis.

The contour-lines are mainly orientated so as to allow the houses a good bipolar North-South orientation, the best one to give a good solar recuperation in the winter, without any risk of too high summertime temperatures. This disposition gives moreover the occupants a nice view on the small valley. The breadth of plots usually of 8 m, has been raised up to 10 m, in order to increase the South façade area.

Given the present access roads, the general site is distributed into two sorts of houses : the houses of the first group are accessible by their South-East side, whereas the others by their North-West part. The architectural solution for the first type of houses will be more difficult than for the second one, because the South part must incorporate both the general entrance (not heated) and the living-room, with a window area as large as possible, in order to give the house a good solar recuperation. The garden facing the living-room is directly connected with the road ; this requires special architectural precautions to avoid any loss of intimacy in the living-room.

The most important wind parameters to take into account for thermal considerations are the cold wind prevailing directions, with considerations for the mean wind speed and the wind temperatures having an influence on the heating energy needs, i.e. below 18°C (usually considered as the internal mean consign temperature of no heating). The usual average value of wind speed (already considered in the meteorological data in the design methodology) is 4 m/s. The wind graphs calculated for all the Belgian meteorological stations during the heating season allow to determine two large orientation sectors corresponding to the most unfavourable winds to the infiltration losses. These sectors are respectively North-East and South-West [2]. The settlement layout has taken these wind graphs into account by reducing the exposition of the houses to these winds, offering them so an interesting microclimate.

Sun-path diagrams have been used for the prediction of insolation and the determination of overshadowing by external obstructions, i.e. the ground, the garages or other houses. It is important indeed not to privilege a few houses, better orientated, to the detriment of other houses, which are downwards. Overshadowings periods have been weighted by the related solar radiations, in order to give an energetical point of view to the assessment of relative positions of houses in their own group or the interrelative positions of groups. The maximum resulting solar incident lost energy is 5% maximum, including the 3% reduction caused by the site itself . Figure 1 gives the resulting settlement layout.

1.3. Feasibility study of the project and outline proposals

The first stage of the design methodology consists in a feasibility study of the project. No design is studied, no solution is outlined : the whole architect's attention is only focused on the research of acceptable values of main global parameters (shape factor, heated floor area, volume, global heat loss coefficient). These parameters characterize a projected dwelling which must be acceptable from multiple points of view : technic, energy, costs. The feasibility study allows the architect to see if an architectural solution exists or not : he manages the main global parameters in order to obtain satisfactory results.

The feasibility stage is mainly concerned with :

- the space allocation, related to the architectural program given by the National Housing Society ;
- the study of the shape factor, which is the ratio between the envelope area (i.e. the total gross area of all the fabric elements surrounding the heated space) and the net area of the heated space ;
- calculation of the internal comfort temperature, which is inspired by the human data and weighted according to the occupancy profile ;
- progressive hypotheses on the insulation degree of all the fabric elements (opaque or glazed) and on the glazing factor ;
- calculation of the global heat loss coefficient (W/K) including the envelope and the ventilation losses ;
- calculation of the annual heating energy needs by the use of a graphic method achieved for the Belgian climate and taking the solar gains into account.

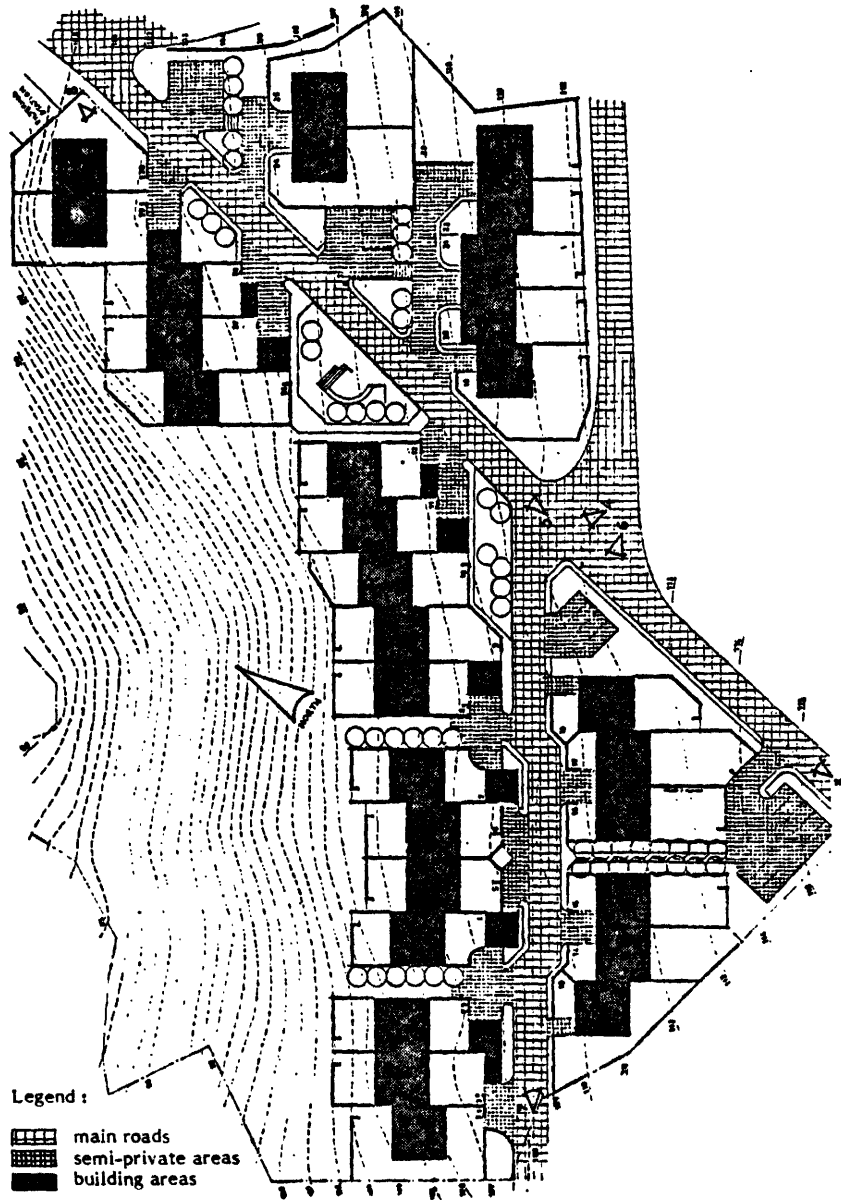

Fig. 1 : Resulting settlement layout of the 30 houses previously foreseen on the site

The final product of the feasibility study consists in a set of global parameters representing a whole set of potential solutions reaching the objectives defined by the client at the inception stage. In other words, the shape factor, the global heat loss coefficient, the glazing factors, etc., have been silhouetted, in order to become a basis of the outlines to be proposed by the architectural team.

On the basis of the conclusions coming from the feasibility study, three types of designs have been drafted for the houses of the lowest part of the site. They respect the same general space allocation: : the South portion incorporates both the general entrance and the living-room, with a window area as large as possible, in order to give the house a good solar recuperation; the cellar level imposed by the ground slope includes two children's bedrooms, unfortunately orientated North-North-West.

The garages are separated from these houses and laid out along the access road, so they don't require additional roads for accessing the house from the street. They don't take from the house large non-recuperating surfaces (orientated South-South-East). Treated as relatively low volumes, they don't give large masks for the solar recuperation in the house; low volumes located between the public road and the private South-South-East garden place screens which, being usual, increase the garden privacy and, being acoustic, act as obstacles against the noise coming from the street.

Fig. 2 gathers the three designs drafted in order to follow the space allocation previously decided :

- For this type of sloping site, the design A (as compact as possible) is very usual in the country, using a tilted roof. The plan is strictly rectangular. The contour lines of the site will be followed by mutual splitting of houses, which decrease the contact of the party-walls.
- The design B proposes a flat roof. A little complexity has just been introduced : party-walls do not have the same length, in order to give the houses the possibility to follow the contour-lines of the site. The split is inside the plan, by the introduction of an oblique wall.
- The third design C proposes another solution to this problem of following the contour-lines : the party-walls have the same length, but the split (also inside the house itself) is realized with rectilinear angles, easier and cheaper to build. In order to increase the daylighting level on the North side of the living-room, a part of the roof has been tilted and offers an additional vertical wall orientated South-South-East, where additional well orientated windows can be placed. Furthermore, the last two designs B and C give other possibilities of orientations and windows, which see the plot of the house itself and not the neighbouring one.

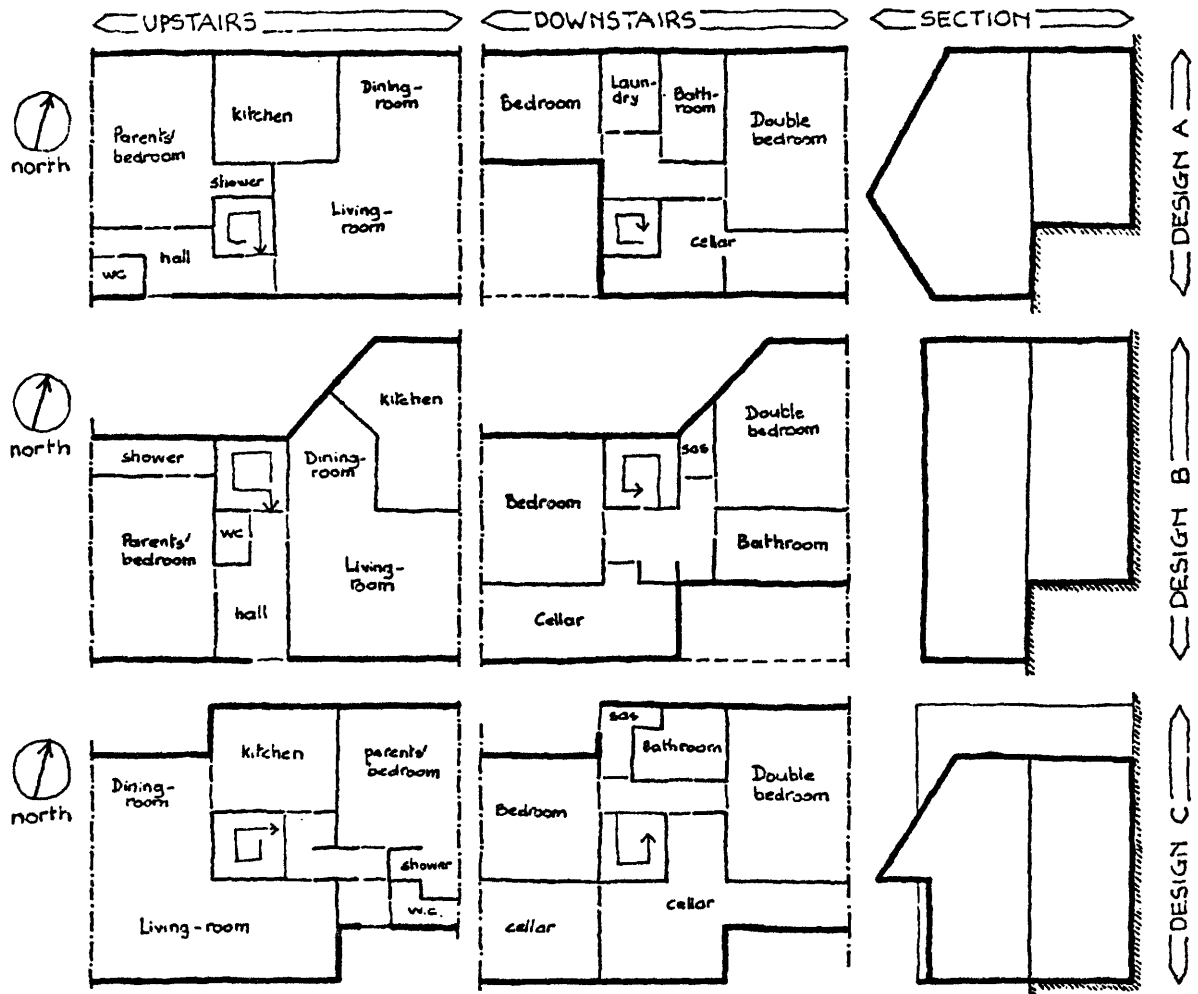

Fig. 2 : First proposed designs in accordance with the conclusions of the feasibility study

For each of the three designs, the global heat loss coefficient (W/K) including air change losses has been calculated. The heating energy needs have also been calculated, in a more detailed way than during the feasibility stage : the monthly recuperating factors and the equivalent degree days (for heating) have been evaluated month by month. The three designs have so been compared with the same fenestration and insulation hypotheses. As we compare the three solutions, we must act several significant differences :

- The shape factor of design A is penalized by the chosen type of roof; the shape factor of B is better, due to the flat roof and the restricted splitting of external walls. The design C shows a relatively poor shape factor, the influence of which will perhaps be eliminated due to the better orientation of windows.
- In design C, only well insulated elements (as tilted roof) are detached from the compact volume and have a nearly negligible influence on its global heat loss coefficient, which is very similar to the one of the second design.
- The better windows orientation of design C shows up clearly in the recuperating factors obtained.
- The annual heating energy needs give preference to the last two designs, the energy consumptions of which remain in a very small range.

As a conclusion of this analysis, the last two designs seem up to now to be the best ones, with the simplified hypothesis that the party-walls were entirely in contact with other neighbour houses.

In order to see the influence of the site configuration, it has been decided to use the same method to calculate the annual heating energy needs of the whole group of 12 houses to be built in the lowest part of the site. These 12 houses are distributed in three groups of 3, 4 and 5 houses; each group has two extreme semi-detached houses and the others are as much in contact as possible, but in respect to the ground contour-lines.

The estimated heating energy needed by the 12 houses for each design solution gives a difference (design C 1.9% better than B) not significant enough to justify any choice on this basis. The choice will be done with the help of other criteria.

On the one hand, the fenestration permitted by design C, more orientated to the South part of the house, will give better daylighting comfort. On the other hand, the introduction of oblique walls in a house plan increases the building costs, due to the more difficult positioning of vertical walls, and the wasted pieces of masonry, cut in order to follow the angles. Rectangular angles are cheaper to be built and more usual in practice.

For these reasons, the design C is then chosen. But a careful eye must be kept on the high recuperating factors obtained, in order to avoid overheating risks, by the right actions. Solar precautions are then to be dimensioned in a way to obtain acceptable summertime temperatures, but without a decreased recuperating factor in winter months.

1.4. Detailed fenestration

a) Fenestration of the South facing windows

From an energy point of view, it is always interesting, in our West-European climates, to increase the South facing windows, which give a good solar recuperation and decrease both the heating energy consumption and the length of the heating season. But overly large South windows without any type of solar protection may give overly high solar gains and as a result, uncomfortable temperature. Thus the extent of the South

fenestration is limited by the overheating risk in the room concerned. Another aspect to consider is the conformance with the Belgian insulation standards, which restrict the value of the global heat loss coefficient. Contrary to French standards, our national standards don't take the solar recuperation into account.

The fenestration of the South windows thus results from a lot of considerations which must be taken into account, such as :

1. conformance with the insulation standards (with the global heat loss coefficient);
2. the appraisal of the acceptable overheating risk;
3. the calculation of the recuperating factor obtained by overcast and cloudless sky conditions;
4. the resulting necessary overshadowing factor (acting only on direct solar radiation);
5. the approach of the maximum accepted temperature by the right dimensioning of the solar protection.

Respect of the insulation standards

In respect of the Belgian insulation standards, an additional aperture of 3 m² has been allocated in the living-room, very often the most occupied room, the most heated and hence the most consuming of heating energy. Furthermore, the large volume of the living-room diminishes the overheating risk, due to a good ventilation easily obtained in summer, if needed.

Appraisal of the overheating accepted risk and the admissible recuperating factor

From a statistical analysis of the climatic data [3], it is possible to determine the apparition frequencies of several climatic conditions. The sensitivity of a house to the solar radiations is approached by the recuperating factor and is supposed to be linear in function of the sky clearness. The statistical evolution of the daily mean temperature without heating can be determined for a period from 1958 to 1975 with weather data measured by the Belgian Meteorological Institute in the meteorological station of UCCLE.

The daily mean temperature without heating t_{WH} is defined as :

$$t_{WH} = t_o + R \cdot \frac{I_{th}}{I_{th \max}}$$

where : t_o (°C) = outdoor air temperature measured for dry air out of any shelter
 R (°C) = recuperating factor due to solar gains
 I_{th} (W/m²) = daily mean total solar radiation on an horizontal plane
 $I_{th \max}$ (W/m²) = the same daily mean total solar radiation on an horizontal plane, but by cloudless sky conditions.

With the help of this definition, tables can be written in order to give, for each month, the number of days when the temperature without heating will be greater or less than a chosen value, in function of the recuperating factor. The duration of the risk has been chosen as 1.0 day maximum for each month ; the maximum recuperating factor becomes, then :

t_{WH}	MAY	JUNE	JULY	AUG	SEPT
27	8.2	5.8	2.8	4.1	6.2
30	11.2	8.7	6	7.1	9.2

Maximum acceptable recuperating factors with a risk of exceeding 27°C and 30°C during one day in each month

The indoor temperature of 27°C is very usually considered as a maximum indoor temperature, but which can be accepted during more than 1 day in a month. The recuperating factors corresponding to 27°C thus must not be considered as absolute barriers not to be crossed. The temperature of 30°C is more representative as a temperature which is very uncomfortable for occupants, the values of associated recuperating factors are to be taken more seriously and - if possible - not to be exceeded.

For cost reasons, we have considered solar protections not on the whole South-South-East glazed surface, but only on the largest window of the living-room. The use of external insulating shutters or solar protection rollers was banished for costs reasons. We have thus designed an overhang outside the window, by using the roof itself.

Calculation of the overshadowing factor and dimensioning of the overhang

In the expression of the recuperating factor of the living-room alone, we can introduce the necessary shading coefficient F , which represents the ratio between the not overshadowed area and the whole window area A . As a first approximation, we can indeed assume that solar protections don't reduce either the diffuse nor the reflected components. We obtain :

$$\bar{F} = \frac{R_{\max} \cdot K - Q_1 - Q_{\text{occ}} - A \cdot \tau_d (I_d + I_r)}{A \cdot \tau_b I_b}$$

- K (W/K) = global heat loss coefficient;
- Q_1 (W) = heat power obtained by solar gains falling on all surfaces, except the overshadowed one, decreased by the longwave losses;
- Q_{occ} (W) = internal heat gains, assumed to be at a constant heat power of 90 W, corresponding to a heavy occupancy profile [4];
- τ_b, τ_d = transmission factor of the glazing for beam (b) or diffuse (d) radiations;
- I_b, I_d, I_r = beam(b), diffuse (d) solar radiations or reflected (r) ones.

The best way to meet this average shading coefficient would be to have graphs giving the monthly value of F for a lot of solar protections. During the computerization of the design methodology, a special effort will be devoted to the appraisal of the shading coefficient. Up to now, it is possible to approach the best F with the help of an hour by hour calculation. With a ventilation rate of 3 ac/h and an overhang of 0.75 m, the room temperature doesn't exceed the value of 30°C, even in July and August. Furthermore, with a ventilation rate of 1 ac/h and the same overhang, the room temperature exceeds 30°C only in July and August. The other overhangs give either a too high risk with 1 ac/h (as 0 and 0.5 m), or too little solar gains (as 1 m). For these reasons, the length of the overhang has been chosen at 0.75 m.

b) Fenestration of North windows

In West-European climates, the heat balance of any North window is always negative, from a strictly heating energy point of view. Thus, any energy conscious architect designs North walls with windows as small as possible. Nevertheless other considerations are to be taken into account in North fenestration, such as the town planning rules, visual comfort and the daylighting level (with the resulting artificial lighting energy needs). These three other aspects of North windows can differently affect the design. In the case of artificial lighting, an optimum fenestration can be found in order to minimize the total energy consumed for both the heating of the room itself and the electricity used for artificial lighting.

Generally speaking, town planning regulations (the respect of which is imperative to receive the authorization to build) take the floor area of the room receiving daylight as the basis for the calculation of the necessary external window area. The minimum glazing (for any orientation) is quite different according to the cities where the building is located : for example, the minimum glazing factor varies from 1/8 in Anderlecht (near Brussels) to 1/6 in Liège.

Daylight prediction and artificial lighting use are important tools in designing the fenestration. Daylight can be handled quantitatively by calculating the daylight factor at the point considered in a room. The split flux method developed by the Building Research Establishment is accurate enough at this design step for predicting the daylight level and the resulting use of artificial lighting. Typical occupancy profiles give information on the periods of any room occupation, when the occupant is supposed to switch automatically the artificial lighting on at the moment when natural lighting becomes insufficient. These switching-on periods correspond to the electrical energy consumed by the installed lighting power, previously defined with the help of the well-known British Zonal Method.

The primary energy balance gathers both the artificial lighting electrical consumption and the heating energy consumption of the room itself. The efficiency of the power station producing electricity has been assumed to be $1/3$, and the efficiency of the whole fuel oil boiler heating system evaluated to be 0.60.

This above mentioned procedure has been applied for the kitchen with :

- no window at all (academic exercise)
- the West window alone
- the West window and a square additional one in the North side, with dimension from 0.6 x 0.6 m to 1.15 x 1.15 m.
- the West window and a rectangular one from 1.15 x 1.15 m till 1.15 x 3.2 m (the maximum aperture).

Figure 3 gathers the results obtained (in kWh/yr). The two curves obtained for the artificial lighting energy consumption and the heating energy consumption are evident : for the artificial lighting, the curve starts from a maximum (no window) and decreases progressively to an asymptotic value. Of course, occupancy hours before sunrise or after sunset always require artificial lighting for any fenestration condition. They represent the minimum asymptotic value of the artificial lighting energy consumption. The heating energy curve is just the opposite : starting from a minimum (no window), it increases more rapidly and continuously. The sum of both curves fortunately presents a minimum ; this minimum value of total energy consumed is not fixed with a high accuracy, because the slope of the curve is very small. Thus the final choice of the right window is rather large, in this case.

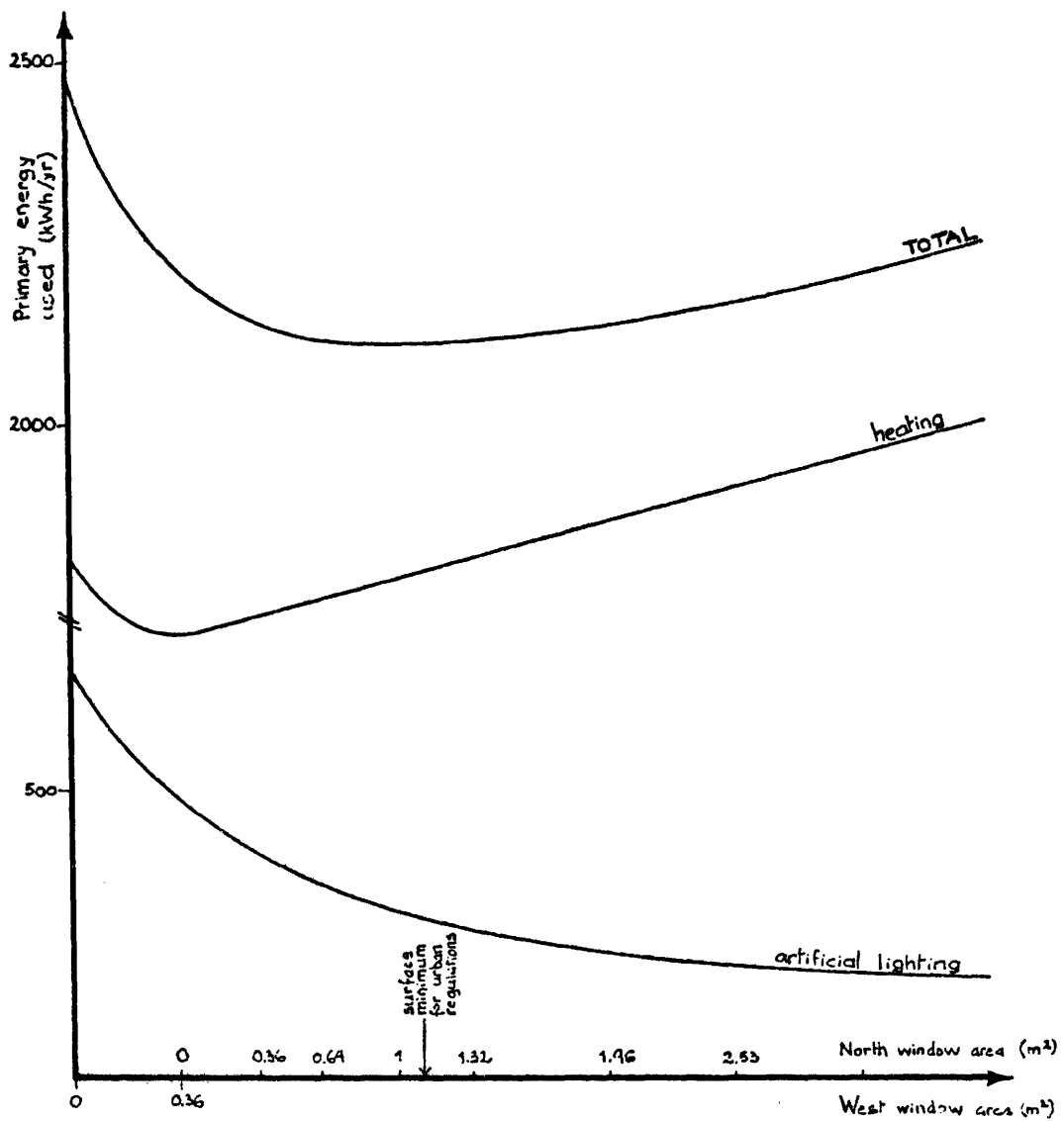

Fig. 3 : Energy balance of the kitchen North window

1.5. Detailed design

The detailed design of the houses included the right dimensioning of the insulating materials thickness and the choice of their positioning in the fabric. This last stage of the design has been carried out, by running the LPB4 program (static and multizone), which has given us the sensitivity of the energy consumption to the insulating materials thickness. The right thickness and positioning have been chosen according to the energy consumption, the cost of the insulation and the respect of the Belgian regulations related to the global heat loss coefficient.

The low price and favorable properties of accessible thermal inertia, high insulating value and good weather resistance makes the multilayered external walls with a facing of plywood or slates the preferred choice :

1. The interior wall, made from heavy concrete blocks, is used for both structural support and provide thermal inertia in the building.
2. Insulating panels placed directly against the interior wall, interlaced with a lattice of wood, provide the thermal resistance of the wall. Two alternate layers allow the panels to cover most of the wall, reducing the potential thermal bridges to the crossing points of the wood lattice.
3. The outer layer is used as a "skin" to protect the insulation from wind and water. This skin is composed here of asbestos cement shingles or wood panels. Between the weather-tight skin and the insulation a small air space is left by using an additional wood strip to assure for easy circulation of air, which keeps both the skin and the insulation behind it dry.

This type of external wall is relying only on usual construction techniques and materials and so remains cheap. But its installation presents the interest of a continuous control during the construction and gives so the guarantee that the expected properties of the materials could actually be realized (for energy saving reasons).

In spite of this type of wall, the connection of window frame with the external wall would put the window as far as possible from inside, in order to minimize usual thermal bridges, to approach the solar radiations recuperating element (the glazing) near outside, to give a better visual comfort, etc. An original, cheap and simple solution has been designed.

The window frame system consists in two sorts of problems : the frame supporting the glazing material in the sash and its connection with the surrounding wall. The problems are rather different and must be differently treated. It is easier to separate the connection to the wall from the window frame, in order to affirm the joints, and treat them by the materials which adequately stuff them. This is the reason why the design team has remodelled the conception of the sill and the jambs by replacing them by an intermediate peripheral frame between the window and the wall. This casing presents a lot of advantages (see Fig. 4) :

1. Used as a mould by the mason during the building of the masonry wall (a), it is taken by the carpenter having thus the right dimensions of the masoned hole in the wall (b).
2. The carpenter can build the casing and the attached window, in his work-room (c). He comes with the whole in the building site and puts it in the wall (d).
3. The casing provides a peripheral support to the window frame (e) which can be put as far as possible from inside, just in the definitive façade plane (f). Thermal bridges are thus reduced to a minimum, as well as the shading mask.

4. In the same time, it provides the internal finishing of the wall hole, where plaster becomes useless.

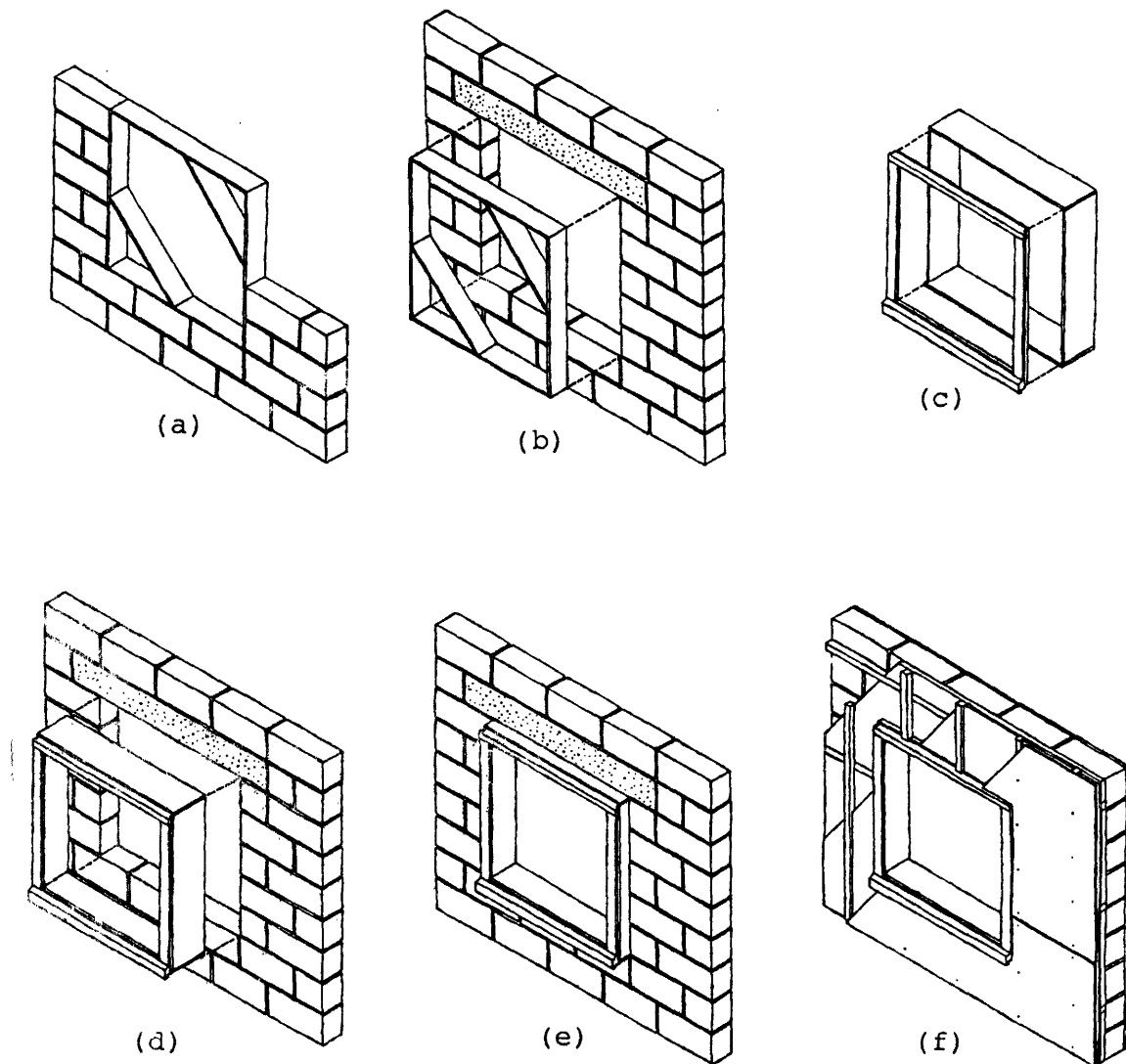

Fig. 4 : Summary of the operations of the window construction details

REFERENCES

- [1] A. DUPAGNE, M. CORNET, Basic characteristics for low-cost houses in order to reduce the energy consumption for heating. Link programme - coordination and consequences for the architectural design (synthesis) - CEC Contract N° 615-78-IEEB, Architectural design handbook : design methodology, February 1981.
- [2] L. MUYLDERMANS, Préoccupation énergétique en urbanisme, Programme National Belge R&D Energie, S.P.P.S., Belgique, 1981.
- [3] L. LARET, Etude de l'influence des paramètres d'isolation des bâtiments sur leur consommation de combustible. Température sans chauffage et modèles de rayonnements. Pertes par le sol. Modèles dynamiques simplifiés. Conditions climatiques extrêmes, Final report of the research IRSIA/CSTC/ULG, convention n° 3279, November 1981.
- [4] J.M. HAUGLUSTAINE, Evaluation of Housing Heat Gains due to Metabolism, Artificial Lighting, Appliances and Domestic Hot Water Use, ICEUM III, Berlin, October 1981.

2. BUILDING OF THE HOUSES AND SUPERINTENDENCE

Walloon budgetary imperatives have reduced the number of houses immediately built (in 1982) from 25 to 5 only, while the other twenty ones will be built later (in 1985). It was important for the research team to have a minimum number of realized houses, in order to be able to make the measurements and so confront the actual results to the theoretically expected ones.

The five houses have been built within 100 days, from August to December 1982. The research team has followed the building works in Marchin, from the energy and the methodology point of view : it has carefully observed the positioning of the insulation layers and -if needed- has given some remarks to the workers, in order to obtain resulting buildings with a thermal quality as close as possible to the expected one, i.e. needing 50% less energy than other common social houses. They indeed must consume 1500 fuel oil liters/yr, in the Belgian climate with an annual amount of 2842 degree-days 18/18. The few problems encountered during the building works concerned especially the difficult rainy conditions during the placing of insulation : additional precautions have thus been taken in order to obtain insulating panels as dry as possible.

The only important problem was the bad care brought by the carpenter during the placing of the frames and casings. Wrong fixings of both the casing in the wall and of the frame in the casing (only nailed, instead of glued and screwed) have emphasized the joints; furthermore no souple material (although imposed) had been introduced between the casing and the wall. In order to correct these errors and to prevent air infiltrations by these two unfilled joints, the research team has required the placing of silicone between the window frame and the casing, and the injection of polyurethane foam between the casing and the wall. Each window has been checked in details to see if these corrections were actually realized.

3. COMPLETION ENERGY INSPECTION OF THE HOUSES.

The research programme had foreseen a completion inspection of the houses just after the end of the building works, in order to analyse the possibility in the field of completion inspection of newly constructed buildings, especially with regards to the energy consumption. Therefore the Belgian Building Research Institute, charged with this task, has undertaken a number of calculations and measurement actions on the real buildings, in order to verify some possible techniques from a methodological point of view [1].

As the main objective was a completion inspection, and as the buildings were newly constructed, the following actions were undertaken in the first campaign :

1. the classical heat loss calculation for the houses, room by room, according to German Standard DIN 4701 (in common use in Belgium), with different assumptions of indoor temperatures;
2. the calculation of the solar recuperating factor of the houses, with different assumptions regarding the shadings;
3. a detailed measurement campaign in 2 houses by using the co-heating technique (electric heaters in each room), in order to relate the energy consumption to the temperatures and the climate;
4. the check of the assumptions on air infiltration by using pressurization tests and tracer gas measurements and by analyzing their relationship.

In addition to the previously mentioned actions, secondary effects were measured : the relative humidity was particularly measured by direct graph readings, during a period of 16 days. A preliminary analysis of the first results can conclude that the weak correlation obtained with the coheating method is probably due to the problems associated with the newly instructed buildings :

1. the influence on the results of the humidity brought during the construction itself, the drying-out process of which is only starting;
2. the too big uncertainty factor of the heat balance of really low-energy houses having low ventilation rates, but high losses to uncontrolled spaces (cellars, ground,...).

The pressurization tests, confirmed by the tracer gas measurements, let assume to have an air infiltration rate of 0,25 ac/h. This value is very low in comparison with the rate of 1 to 1,5 ac/h commonly observed in the context of social houses. The special care during the building works seem to have bore the expected fruits.

In a second campaign, some of these measurements have been repeated, in order to analyze aging effects on the energy consumption parameters [2].

This second report describes the measurements made about one year after the construction of the houses. It contains :

- results of the co-heating tests on envelope performances and on a classical heating system;
- results of the measurements of the U-values;
- results of the ventilation and pressurization measurements.

REFERENCES

- [1] P. CALUWAERTS, D. L'HEUREUX, Completion Inspection Techniques (Energy Aspects), BBRI Devl. n° 4153, Part 1, July 1983.
- [2] P. CALUWAERTS, P. WOUTERS, D. L'HEUREUX, Completion Inspection Techniques (Energy Aspects), BBRI Devl. n° 4153, Part 2, September 1984.

4. MONITORING OF THE MARCHIN HOUSES

The aim of the **completion inspection techniques**, as described hereabove, is the direct estimation of some thermal key parameters. It is the reason why this analysis can be achieved on a short time (a few days only) and by the discussion on a few parameters.

The interest of the **monitoring** stands in the evaluation of the significancy of the parameters; thus any monitoring involves the experimental measurement of their sensitivity and the statistical interpretation of them. During a monitoring, the highest number of data on space and time are to be recorded. All the informations contained in the raw data are to be used as long as possible.

4.1. Main aspects of the Marchin monitoring

Measurements are made on five attached houses, and could be extended to twenty houses. Three of the five houses are occupied; the two unoccupied houses are used as references for the analysis of well defined effects. More than 200 points are to be recorded with the logger. It necessitates a network well organized, in spite of the difficulty of interfacing different appliances having a poor information about their hardware details.

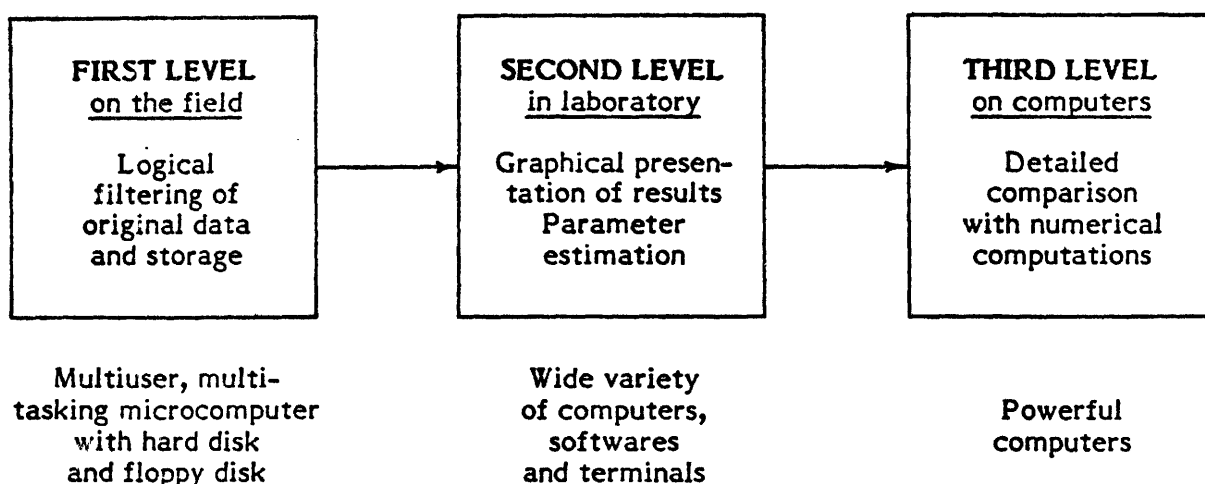

Fig. 1 : Steps of data analysis

A three level data process was designed to use the different available computers in an optimal way (Figure 1). Due to the mass of data to be processed, a general software would be strongly desirable, in order to feed the existing standard library (statistics, simulation...) with the raw data provided by the in situ measurements. Such a kind of software does not exist yet; nevertheless it should be essential at some level of monitoring for a rigorous interpretation.

4.2. Measurement system.

Each room of all the houses has two globe temperature measurements, obtained by thermocouples placed at a 12 cm distance from the wall, in a globe of 3 cm diameter; the living-room is divided in two zones and, so, considered as two rooms. One globe is positioned 1,80 m above the floor, while the second is placed 10 cm below the ceiling. We obtain so at least 20 points in each house. Furthermore two points are recorded with platinum resistance at 1,80 m height : the first one is in the eating zone of the living-room, the other in the little bedroom (downstairs). Thermocouples record also one cellar temperature, the cold water temperature (and the temperature difference with the hot water), the temperature of the hot water supplied by the boiler and two temperature differences measured in the hydronic circuit. Four electric counters are recorded, giving information on the electric consumption of the small power appliances, the high power ones, the artificial lighting and the total electric consumption of the house. Burner runnings are recorded. We obtain thus 33 measurement points in each house. Two flow counters have been added in each house; some other temperature probes have been placed in the unoccupied houses.

The weather station allows six temperature measurements : each point is measured with a thermocouple and with a platinum resistance. There are also, at least, two measurements of total solar intensity on horizontal plane and two rain detectors (one horizontal, the other at a slope of 45 degree in West orientation); the wind orientation and its horizontal velocity are recorded.

The wiring between each probe and the logger is organized in a network as shown on Figure 2.

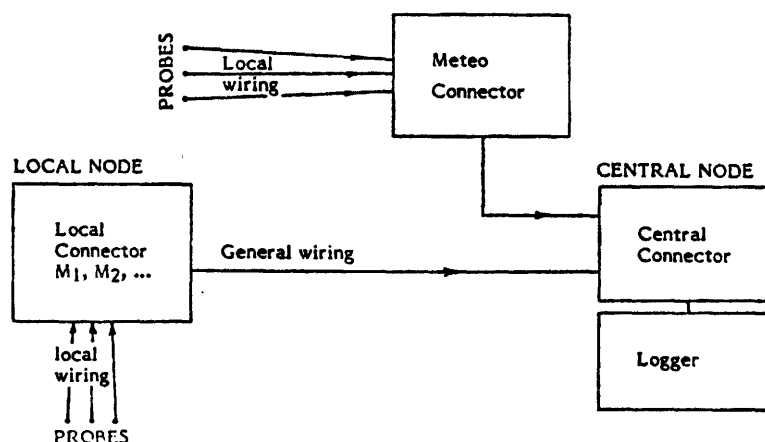

Fig. 2 : Principle of wiring network between probes and logger

The data logging system is built around a rather powerful logger (Solartron ORION), connected with a microcomputer able to work in a multi-tasking and multi-user operating system (MPM II). By the use of a phone and a modem, this system is the source node of a computer network involving the computer of the University (Figure 3).

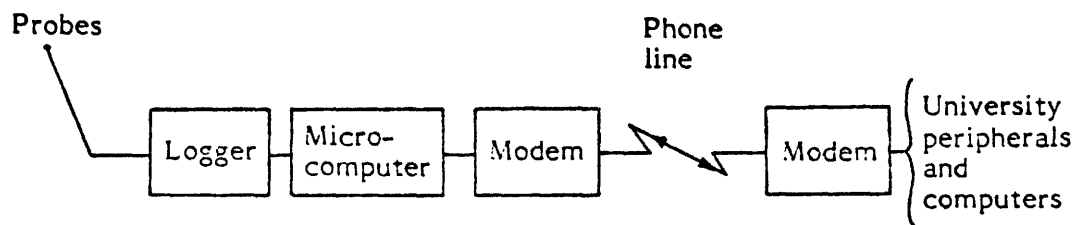

Fig. 3 : Data logging network

The multi-tasking possibilities of the microcomputer allows a real time data process on the site, provided that power failure resets on computer are avoided [1].

4.3. Measurements.

Measurements are made simultaneously in the five houses and in the weather station. The sample frequency of data acquisition is 15 seconds for weather data and 10 minutes for data measured in houses. The recorded values are the hourly mean values and the associated standard deviation. With this information, the general behaviour of the group of five houses can be analyzed as well as the individual behaviour of each house and the zoning effects. The reliability of weather data (a critical measurement) is warranted by the multiplied measurements of similar variables. With the phone line and the modems, all operations on the site can be controlled at any time from the Laboratory.

Measurements confirm the good quality of the thermal resistance of the houses. The continuous insulation placed outside and coupled with a thermal mass easily accessible from inside gives a negligible daily oscillation of t_{ψ_H} . Its measured amplitude of oscillation indeed is varying from 1°C to 2°C maximum in the most sensitive rooms. This thermal behaviour is the guarantee against overheating during the day or against night discomfort. No overheating has been measured during the dog-days of July 1983 : under clear sky conditions and with a peak outdoor air temperature close to 35°C, the peak indoor globe temperatures were recorded only around 28°C.

REFERENCES

- |1| COMMISSION OF THE EUROPEAN COMMUNITIES, R. FERRARO, R. GODOY, D. TURRENT (Performance Monitoring Group), Monitoring Solar Heating Systems : a practical handbook, Pergamon Press, published for the CEC, 1983.

5. COMPUTERIZATION OF THE DESIGN METHODOLOGY.

The research program has foreseen the re-writing of the design methodology on a computer, in order to speed up the calculations (up to now only manual), thanks to the computing power brought by the computer. Of course some large programs exist already on big computers; these programs are quite able to calculate heating (or cooling) loads, heating (or cooling) energy needs, summertime temperatures, etc. But the data required are so complete that these programs become applicable only to buildings which design is finished, i.e. exactly when important modifications are impossible anymore. Any modification on the design must be done as early as possible in the design process, i.e. exactly when the data are not defined yet and the drawings still woolly. This is the reason why the design methodology has brought its major effort on the possibility of simulating the thermal behaviour of a building not designed yet, not drawn yet and just known through its global parameters.

The computer chosen for the support is a microcomputer, more accessible to most architects than mini or big computers. Microcomputers offer a hardware system with very interesting capabilities for a cost remaining accessible to the majority of architects, who can also use it for other software possibilities, such as word processing.

During the feasibility stage, the architect facing the terminal chooses a combination of the main global parameters, i.e. :

1. human parameters (heated floor area, consign temperature and internal gains), deducted directly from the architectural program);
2. geometrical parameters of the building (shape factor, glazing factor, heated volume);
3. thermal parameters of the building (U-values, rate of air change, absorption and transmission values) directly used in the calculation of the global heat loss coefficient.

The building, characterized by the geometrical parameters, will be able to satisfy the client's energy target if its thermal quality allows to obtain satisfactory heating energy needs, for the human parameters previously defined. The whole system (= building + human + climate) giving a good solution will be characterized by a good combination of the different parameters (Figure 1).

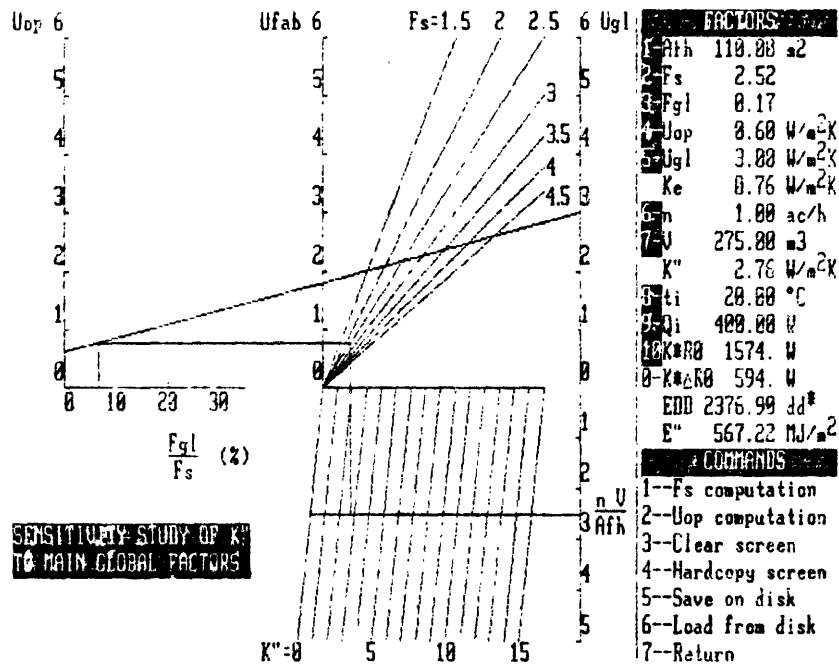

Figure 1 : Sensitivity study of the global heat loss coefficient K'' and the heating energy needs E'' to the main global parameters.

In order to guide the architect to a reasonable choice of geometrical and thermal parameters, sensitivity graphs are drawn on the screen and the user of the program is able to manage parameters which are the direct components of more global parameters. For example, during the calculations of the shape factor F_s , the architect is able to visualize (see Figure 2) the influence of the geometrical options of his future project (plan aspect factor, grouping factor, number of levels, ...). He can also decide, with full knowledge of the consequences of his decisions.

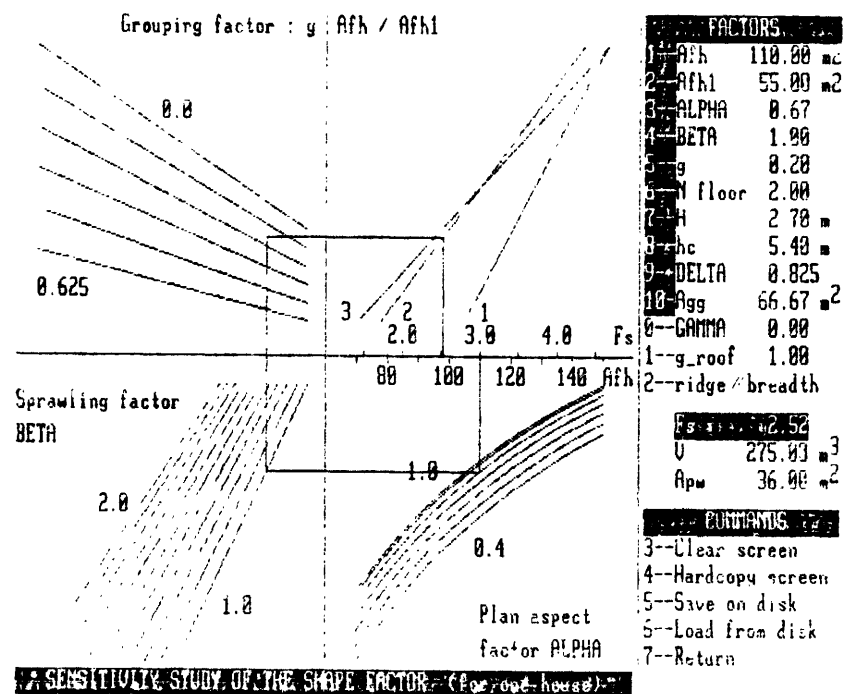

Figure 2 : Sensitivity study of the shape factor (for one house).

Another screen allows the user to visualize and to manage the glazing and opaque characteristics of his project (Figure 3), and so settle a more accurate value of the recuperating factor.

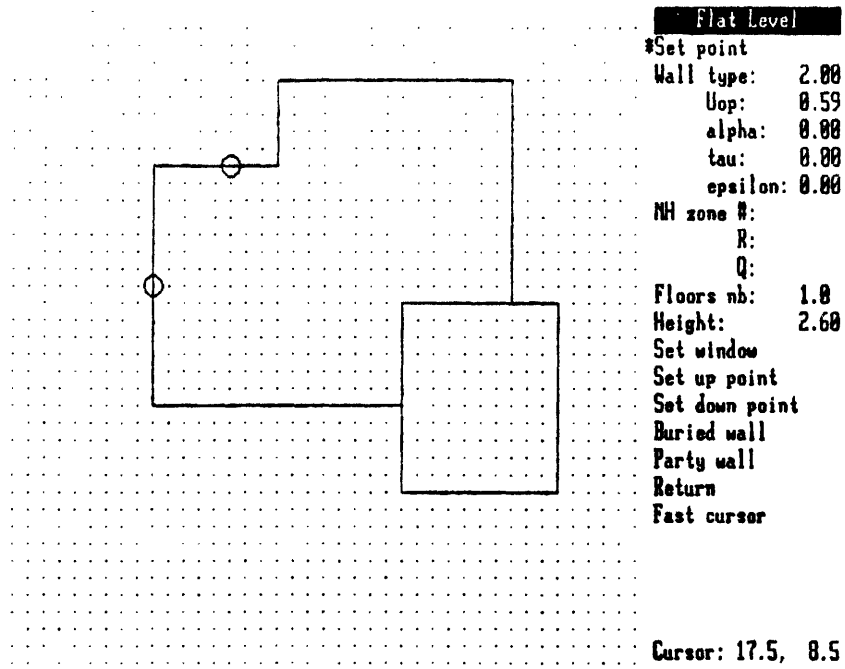

Figure 4 .

2. On the other hand, some other data concerning shading masks can also be introduced. The user selects on a cylindrical projection of the skyline around the building, the sectors which are shaded by surrounding obstacles (Figure 5).

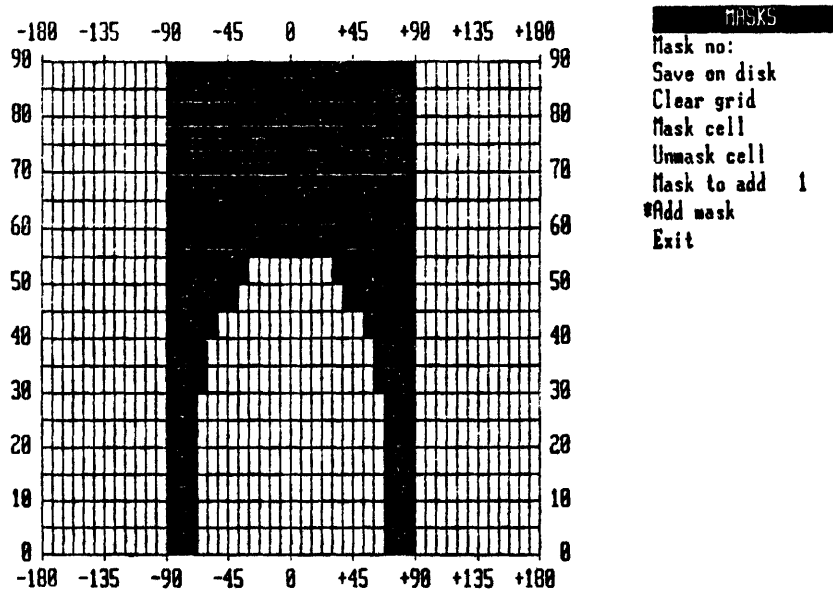

Figure 5.

From these data, the program itself computes the main global parameters, which are assessed according to the satisfactory values resulting from the feasibility study. If the feasibility target are not reached, the user can modify the data before the calculation of the heating energy needs, the Walloon standard insulation level and the mean summertime temperature.

At this stage of development, there are, of course, several procedures which are to be written until we could consider the computerization of the "Outline Proposals" as completed :

- a procedure generating the bill of quantities on the basis of the graphical data introduced by the user;
- a procedure solving polygons intersections and adjacencies between volumes. This procedure would thus allow the computer to "understand" the geometry of the building, especially differentiating heated and no-heated zones and detecting corresponding thermal contacts;
- a procedure completing thermal calculations on the basis of the recuperating factor, taking into account shading factors and separating computations according to beam, diffuse and reflected contributions.

The module called "Outline Proposals" of the computerized methodology will allow to evaluate quickly and interactively the heating energy needs of any building broken up into heated and no-heated zones, located in its built environment and in its geographical site.

All modules already written were developed with the constant care of bringing a maximum of flexibility to the user, allowing him to easily modify the data and directly get the energetical evaluation of his choices.

6. ANALYTICAL TOOLS

The practical use of the design methodology in a real design case made apparent some embarrassing lacunas. In order to improve its completeness we decided to devote some research efforts to the development of calculation methods. Detailed reports on analytical tools can be found in volume number 6 of the present final report. This reports looks, at first glance, like an addition of disjointed chapters where every interested person can find his or her own way. But this was not the only nor the major goal we followed up when presenting a whole volume of the final report devoted to the work done on calculation methods. Of course these unconnected chapters will find a complete coherence when integrated into a future and more complex methodology as already said here above. But, henceforth they have in common some specific characteristics coming from their design orientation.

In the book the reports have been arranged into four chapters, each of them being concerned with one topic. In this synthesis report we shall use the same subdivision.

6.1. Dynamic modelling

This part of the work tries to make a first run through an important, difficult and often neglected topic in the design process : the evaluation of the efficient fraction of the building thermal inertia. Of course, this difficult approach is not yet in its completed form but the usefulness of the models has been demonstrated by their application to realistic examples where summertime temperature and intermittence efficiency are evaluated.

This section is divided into two sections. The first one is a theoretical discussion on dynamic simplified models and on their use within the design process. The second one presents a simple dynamic model and its practical application on some examples.

a) Concept of simplified dynamic models of building thermal behaviour

The goal of this theoretical discussion is to clarify the concept of simplified dynamic model in order to evaluate its applicability to the design process. Simplified dynamic models can be used in two very different ways. They can provide numerical evaluations of dynamic building performances and so look like simplified computations such as admittances method or weighting factors. But they are more powerful and can do much more than that.

Simplified dynamic models can also be used to improve the understanding of the general dynamic behaviour of a building when classical large models cannot be used. Sensitivity studies are of major importance in the design process, but they are difficult to perform with large and complex models because they are too heavy and time consuming, and which is more, they don't give the answer the designer is looking for. In fact, he is not interested in a highly accurate value of a certain thermal quantity which would be too distant from the design criteria he has to satisfy, and calculated for some variables and parameters beyond his power.

What he would like to have at his disposal is a simple tool allowing him to experiment the sensitivity of physical values to the changes he causes on the physical characteristics of his design. In other words he would like to have an answer to his own problem expressed with his own words.

The design orientation of the analytical tools has been the constant care of the first research work and the design methodology we produced is an exact illustration of this peculiar attitude towards simplified models. In this steady-state simplified model, the building thermal behaviour is characterized by a simple physical concept, i.e. the recuperating factor to the solar radiation. This steady-state parameter is computed according to the building thermal properties through the use of the so called global factors of the building. The recuperating factor can of course give a simple evaluation of the heating energy needs by computing equivalent degree days, but, as Louis Laret says it, [3] "first and foremost, they integrate the fundamental physical properties of the building into a usable form".

The same attitude can and must be maintained when developing simple dynamic models of building thermal behaviour. The purpose of this paper is to demonstrate the usefulness of the eigenvalues (or time constants) of the building mathematical model, and their weighting for a given input-output as an appropriate parameter set.

The methodology proposed in this report provides a quick a priori computation of these parameters, based on the inspection of the structural and thermo-physical data of the building. Computation with complex models and experimental results have validated this technique which appears to be complete and self consistent.

b) Simplified method for the determination of room-air temperatures in summer-time and of the intermittence efficiency during the heating season

This second part of the report on dynamic modelling is mainly a practical application of a simple model to determine the thermal behaviour of a physical structure.

The model can be represented by an electric diagram as follows :

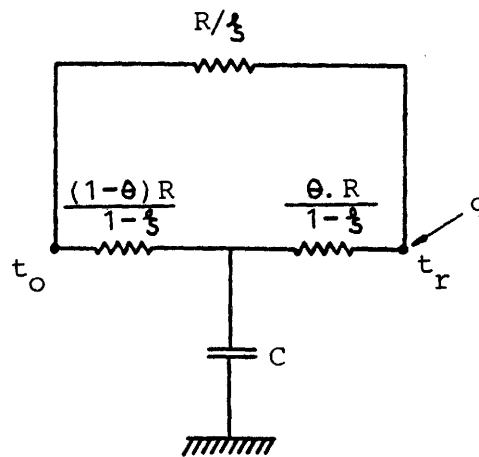

Fig. 1 : Electric schematization of the model

The parameters of the model are :

- steady-state parameter
 - R : thermal resistance of the system
- dynamic parameters
 - C : global capacity
 - θ : determines the position of the capacity in the resistance $R/1-\xi$
 - ξ : divides the resistance into two parts :
 - R/ξ : the part remaining unaltered under transient conditions, the part with which the undelayed losses are associated (ventilation, losses through glazing)
 - $R/1-\xi$: the part of the resistance with which the capacity C is associated.

These dynamic parameters are transformed into :

- τ : the time constant of the system
- a^q : the rise of the system (instantaneous response) to a step of internal unit-flux q
- a^T : the rise of the system to a step of external unit-temperature T .

Steady-state parameters are calculated by classical means; and dynamic parameters are approached in two ways according to their dependence on the wall effects or on the coupling between zones.

Applications of the defined model are developed as well for the evaluation of internal peak temperature as for the calculation of the energy saving potential due to intermittent heating.

This research work has been carried out in the Building Physics Laboratory of the University of Liège within Belgian National R&D Energy Program. But according to its great interest and its close relation to the present purpose it has been decided to introduce it into this report. Its strong relation with our design orientation is not a pure chance, it is due to its author. M. Cornet was, in fact, the research worker attached to the first European contract where the design methodology has been developed.

6.2. Degree-day methodology (in collaboration with L. LARET)

The heating energy need calculation included into the manual design method developed by our Laboratory in the frame of the First European R&D Energy Research Program was based on a "degree-day" type algorithm.

This degree-day method was designed to take into account the thermal effect of solar radiation through windows and of human occupancy of the house. That was the reason why we called it "equivalent degree-day method" [1], [2], [3], [4]. It had the good fortune to become soon very popular in the Laboratory and so received the most critical appreciation.

People generally consider it as very useful and efficient, especially during the design process, but some have the feeling that it overestimates the solar gains and claims for new development in heating load computations taking the sky cover into account.

Others ask for a more practical tool and regret not to have any efficient mean, at the present state of the method, allowing to manage mask shadings. This would of course imply the splitting of sky radiation into its separate components (diffuse, beam and ground reflected terms). And, finally, we have been made aware of cumbersome difficulties encountered by the designer due to the incomplete and unrealistic answer of the method. Of course, the "equivalent degree-day" concept which is the final answer of the method may be used as a figure of merit of the design. This concept is obviously linked to the actual heating energy consumption and so can constitute an efficient basis for a useful sensitivity study. But, within the scope of an improved energy service to his client, the architect is not only interested in guiding his design decisions through a fast estimation of loads, but he is also interested in obtaining some guarantee on the actual level of the future energy consumption.

The latter question involves the important and difficult problem of the heating system efficiency as well as a large discussion on the data used in simulation. The first point is presently the major concern of the thermo-physical department of the Laboratory and is out of the scope of this research. Of course, it will be inserted according to the usefulness of the results obtained. The second point is more interesting from the architect's point of view because it is directly related to his objectives. It will be developed in full details part 6, chapter 2.1.

In order to have a better understanding of what is the architect's objective, we would like to mention that he is very often asked by his client to provide direct certification on heating energy consumption and therefore would not be satisfied with a simple energy label.

Assuming the efficiency of the heating equipment is neutralized, this leads to a discussion on the type of climatic data that are to be used. Would it be better to consider the mean standard year or the most probable year? A comparison of the two options is presented.

a) Degree-day methods

Generally speaking, the heating energy load of a given building can be expressed by the following equation

$$EHL = \int_0^T Q_{HL} \cdot d\tau \quad (1)$$

where Q_{HL} is the instantaneous heating demand
 τ is the time
 E_{HL} is the heating energy on a period of time T.

In degree-day methods, this equation (1) is transformed in a particular way.

$$DD = E_{HL}/K = \int_0^T Q_{HL}/K \cdot d\tau \quad (2)$$

where K is the heat loss coefficient of the envelope.

And all of them are based on a rough assesment of heating loads Q_{HL} . The classical and well-known degree-day method is provided with a particularly simple model for Q_{HL} representation and assumes some hypotheses which lead to :

$$DD = \sum |t_{in} - t_{ou}|_+$$

where t_{in} is the indoor mean temperature
 t_{ou} is the outdoor temperature.

The first attempt to improve this very simple method was the "equivalent degree-day" technique which brings about two corrections in the energy balance

$$Q_{HL} = K(t_{in} - t_{ou}) - Q_{sol} - Q_{occ}$$

where Q_{sol} is the inside load effect of outdoor radiation
 Q_{occ} is the inside load effect of occupancy.

It can also be written :

$$Q_{HL}/K = [t_{in} - Q_{occ}/K] - [t_{ou} + Q_{sol}/K] \quad (3)$$

This leads to the definition of two new and very interesting concepts : the temperature of "no heating" t_{NH} , and the temperature "without heating" t_{WH} .

$$t_{NH} = t_{in} - Q_{occ}/K$$

t_{NH} is the temperature at which no heating load is required to maintain t_{in} . It depends on occupancy and heat loss coefficient; it produces very often a decrease in indoor temperature due to casual gains.

$$t_{WH} = t_{ou} + Q_{sol}/K$$

t_{WH} is the natural temperature of the building without heating and occupancy. Thus it depends on the weather by t_{ou} and Q_{sol} and on the building envelope by Q_{sol}/K . The former is the outdoor temperature and the latter is the increment of temperature due to solar radiation.

According to these new definitions, equivalent degree-day on a given period can be calculated by :

$$EDD = \int_0^T (t_{NH} - t_{WH}) d\tau$$

In degree-day methods, the basic step of time is one day, by definition. Thus it takes the form :

$$EDD = \sum_i |t_{NH} - t_{WH}| + \quad i \in [0, N] \quad (4)$$

where N is the number of days in the period T.

Tables of "equivalent degree-day" have been produced in function of t_{NH} and of the parameter(s) related to the outdoor radiation.

In consequence of (4) and of the previous definitions of temperature of no-heating and temperature without heating, we can say that equivalent degree-day is a function of climatic variables and of some parameters linked to the building characteristics and to the occupancy.

$$EDD = f(\text{parameters, climatic variables})$$

<u>parameters</u> :	Q_{occ}	: inside load effect of occupancy
	K	: heat loss coefficient of the envelope
	t_{in}	: indoor mean temperature, or zone setting temperature
<u>variables</u> :	t_{ou}	: outdoor temperature
	Q_{sol}	: inside load effect of outdoor solar radiation

b) New equivalent degree-day method

As previously mentioned, new developments have been considered for the equivalent degree-day method on the following two effects :

- the choice of typical weather data
- the radiative modelling chosen with the difficult compromise between accuracy and simplicity of computations.

The choice of significant weather data (for a given use) is discussed in details by Louis Laret in the application section of his contribution to the "calculation book" (part 6, chapter 2.1.).

Radiative modelling is the point on which the equivalent degree-day method is to be implemented and made more powerful for design analysis. It must become able to reach the following two goals :

- to provide a more accurate energy need estimation, taking the effect of sky cover into account;
- to supply the architect with a practical tool for the design of windows and shading masks by splitting sky radiation into its separate components.

In fact these two problems bear on the chosen representation of the inside load effect of outdoor radiation Q_{sol} .

Louis Laret proposes a first expression corresponding to commonly accepted hypotheses :

$$Q_{sol} = \sum_i \left\{ A_i \left[(\alpha_i U_i/h_{oi} + \tau_i) F_{Si} I_{ti} + \varepsilon_i U_i/h_{oi} F_{Ri} I_{Ri} \right] \right\} \quad (5)$$

where	A_i	area of surface i of the envelope
	I_{ti}	total solar intensity on surface i
	I_{Ri}	sky longwave intensity
	α_i	outdoor absorptance
	Z_i	transmittance
	U_i	heat losses coefficient per unit area
	h_{oi}	outdoor film coefficient
	ϵ_i	emittance
	F_{Si}	shading effect on solar radiation
	F_{Ri}	shading effect on sky longwaves.

In this expression, the outdoor radiation is represented by I_{ti} and I_{Ri} which are directly defined in relation to surface i . The use of this expression would imply the calculation of these two factors for each surface which is very heavy and impossible to achieve in practical applications. Thus we are obliged to spend some time discussing radiative models that are acceptable to computation models.

The total radiation intensity on an horizontal plane I_{tH} is the most commonly available data, thus the best expression would be of the following format :

$$\begin{cases} I_{ti} = f_1(I_{tH}) \\ I_{Ri} = f_2(I_{tH}) \end{cases}$$

In other respects, it may be interesting to reorganize the expression (5) of Q_{sol} in order to make apparent its two constitutive factors. One depending on climatic conditions, and if possible only on sky cover. The other one being related only to design parameters of the building envelope.

$$Q_{sol}/K = R_{cs} \cdot f(J) \quad (6)$$

where	$J = I_{tH}/I_{tH\ cs}$	sky clearness index
	$f(J)$	a function depending on the chosen radiative model for any sky conditions
	R_{cs}	recuperating coefficient.

The parameter R_{cs} depends on optical properties of the building envelope and on radiative hypotheses in clear sky conditions only. Thus it changes along the year but according to conventionally fixed radiative data (clear sky). So, the recuperating coefficient can be considered as a very useful design parameter which gives an objective measure of the building's ability to recuperate the solar radiation. Its computation depends directly on the estimation of $(I_{ti}/I_{tH})_{cs}$ and $(I_{Ri}/I_{RH})_{cs}$.

The factor $f(J)$ is a function which depends on the radiative model for any sky conditions. It is subordinated to the modelling of I_{ti}/I_{tH} and I_{Ri}/I_{RH} .

Fortunately, the radiative model giving a complete splitting of the two factors is also the simplest. It is based on a hypothesis proposed by R. Dogniaux [5], expressed by the following relation :

$$I_{ti}/(I_{ti})_{cs} = I_{tH}/(I_{tH})_{cs} = J$$

In this case, equation (6) becomes

$$Q_{sol}/K = R_{CS} \cdot J \quad (7)$$

This model was used in the first "equivalent degree-day" method developed in the Laboratory. In this case, the DD chart depends not only on the temperature of no-heating t_{NH} , but also on the recuperating coefficient in clear sky conditions R_{CS}

$$EDD = f(R_{CS}, t_{NH}, t_{WH})$$

It appears that this ultra simple hypothesis overestimates the solar intensity received by South surfaces in medium and overcast sky cover.

More accurate models are obtained when splitting the total solar intensity into its components.

$$I_{ti}/I_{tH} = (I_{bi} + I_{di} + I_{ri})/I_{tH}$$

where

I_{di}	sky diffuse term
I_{bi}	beam term
I_{ri}	ground reflected term

These models have the pleasant advantage to allow a more accurate definition of shading factors and transmittance coefficient of the wall. Thus equation (5) is changed and the first term of the sum becomes :

$$(\alpha_i U_i/h_{oi} + \tau_i) F_{Si} I_{ti} = (\alpha_{di} U_i/h_{oi} + \tau_{di}) F_{di} (I_{ri} + I_{di}) + (\alpha_{bi} U_i/h_{oi} + \tau_{bi}) F_{bi} I_{bi}$$

assuming $F_{di} \approx F_{ri}$ and $\tau_{di} \approx \tau_{ri}$

An estimate of the sky diffuse component can be obtained with the help of a simple correlation between this one and the total solar intensity on the horizontal reference surface (Lin and Jordan like correlation).

Thus, equation (6) can be written :

$$Q_{sol}/K = R_{CS} \cdot [f(J, R_{CC}/R_{CS})] \cdot J \quad (8)$$

where R_{CC} recuperating coefficient in overcast sky cover conditions.

Expression (8) is more accurate than expression (7) and offers the possibility to manage windows and shadings in a useful way. But one has to be aware that one pays this improvement by a more complicated formulation

$$EDD = f(R_{CS}, R_{CC}, t_{NH}, t_{WH}) \quad (9)$$

and a reduced splitting of the expression into two separate factors.

Louis Laret shows in part 6 of the present final report (chapter 2; 2.2) how to simplify the model for a given climate, provided some hypotheses on direct/diffuse and longwave radiation are added.

Correlations can thus lead to transform (6) in :

$$R_{CS}.f(J) = \bar{R}.J \quad (10)$$

where $\bar{R} = a R_{CS} + (1-a)R_{CC}$

Thus $EDD = f(\bar{R}, t_{NH}, t_{WH}) \quad (11)$

c) Climatic data for degree-day methods

An interesting comparison between several computation methods of monthly and yearly mean loads has been made [6] with a typical dwelling representative of the Belgian building stock.

A dynamic hour-by-hour computation corresponding to the most complex model and also to the highest computing effort has been taken as the comparison reference.

We can draw out of this work two conclusions relevant to our purpose :

- divergences between the reference (monthly and yearly) mean loads and the dynamic hour-by-hour computations using daily mean climatic input data are less than 1 %;
- divergences between the same reference (monthly and yearly) mean loads and the static day-by-day computations using daily mean climatic input data are also less than 1 %.

Thus we can say that a single daily mean value characterizing the climate gives a heating energy load estimation at one percent accuracy by means of a steady-state computation extended to a ten day period. Of course this extrapolation is only valid within the limits of the building case studied. However this building structure is very common in Belgium and we can consider it as largely applicable . Restrictions are to be made for peculiar building structures such as mobil-homes, very high or very heavy buildings...

Expression (11) shows clearly the dependence of equivalent degree-day to variables and parameters describing the whole situation

t_{WH} is linked to the climate by the two variables t_{OU} and I_{tH}

t_{NH} is subordinated to the zone setting temperature and to the inside load effect of occupancy

\bar{R} is constructed by statistical mean made on a sample which must :

- be extended on a long enough period;
- remain representative of the most probable occurrence

This can be summarized in a diagram (figure 1) expressing the complex connections existing between the four sub-systems and most of the variables and parameters by which they are represented.

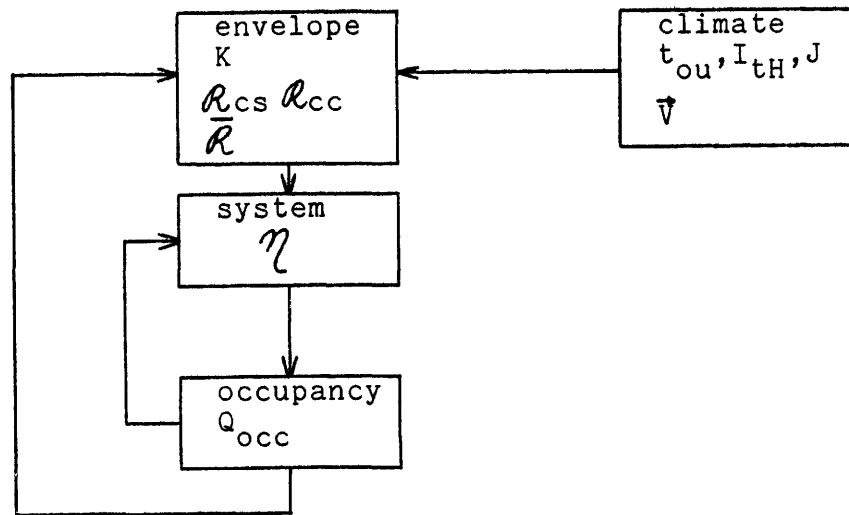

Figure 1.

Degree-days methods are based on daily mean steady state heat balance. In the case of equivalent degree-day method :

$$EDD = \sum_i |t_{NH} - t_{WH}|_+ \quad i \in [0, N] \quad (4)$$

The only unknown quantity indispensable for this calculation is the statistical distribution of

$$|t_{NH} - t_{WH}|_+$$

on the considered period of time.

t_{NH} being a given constant depending on occupancy, the only interesting function is the statistical distribution of days and their associated daily mean temperature without heating.

Thus, for degree-day analysis, we can summarize all the weather data in the distribution function

$$f = f(t)$$

where t is a given temperature
 f is the relative number of days for which $t_{WH} = t$ in the period to look at.

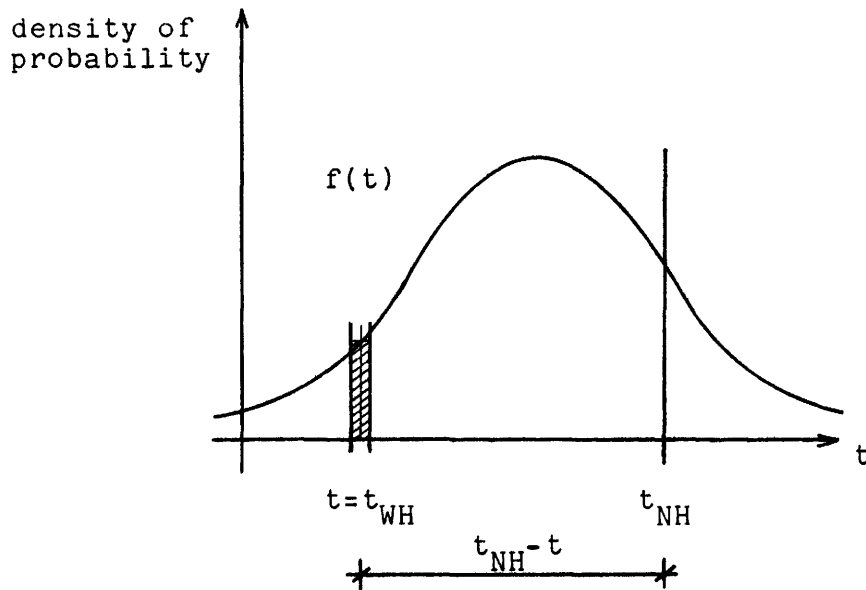

Figure 2.

The distribution function f contains all the required information and we can immediately derive from it the global quantities characterizing the heating-energy need performances of any dwelling.

- **The equivalent degree-day value**

For a given t_{NH}

$$EDD = N \int_{-\infty}^{t_{NH}} (t_{NH} - t) f(t) dt$$

or
$$EDD = N \int_{-\infty}^{t_{NH}} \left(\int_{-\infty}^x f(t) dt \right) dx \quad (12)$$

where N is the total number of days in the period.

- **The length of the heating period**

$$T = N \int_{-\infty}^{t_{NH}} f(t) dt$$

or
$$T = d EDD / d t_{NH} \quad (13)$$

- **The mean temperature without heating**

$$\overline{t_{WH}} = \int_{-\infty}^{+\infty} t \cdot f(t) dt \quad (14)$$

d) Available climatic data files

The statistical distribution of days characterized by their daily mean temperature without heating would be a highly efficient aid in equivalent degree-day calculations, provided that this distribution function would be known or at least estimated.

In Belgium, a continuous set of climatic data measurements covering a 25 year period is available. These data can be used to build different descriptions of the climate that are generally related to the year duration ("mean year", "36-day year"). In order to take advantage of the whole knowledge contained in these files, an approach like the statistical distribution of days and their associated daily mean temperature without heating should be valuable. And, what is more, assuming the climate to be a stationary process in the long term, the distribution function could be considered as representative of the existing climate conditions.

Theoretically, it should be possible to build a distribution function for the whole year from this sample of 25×365 values of the daily mean t_{WH} . But for practical reasons, in a first time, this function will only be approximated by an analytical distribution. Let us take it that this statistical distribution is known. It can be represented in a diagram (Figure 3.a) expressing the number of days N_i when

$$t_i < t_{WH} < t_i + \Delta$$

and $\Delta = 1^\circ\text{C}$.

Of course $\sum_{-\infty}^{\infty} N_i$ is the total amount of days in the considered period (i.e. 365 days).

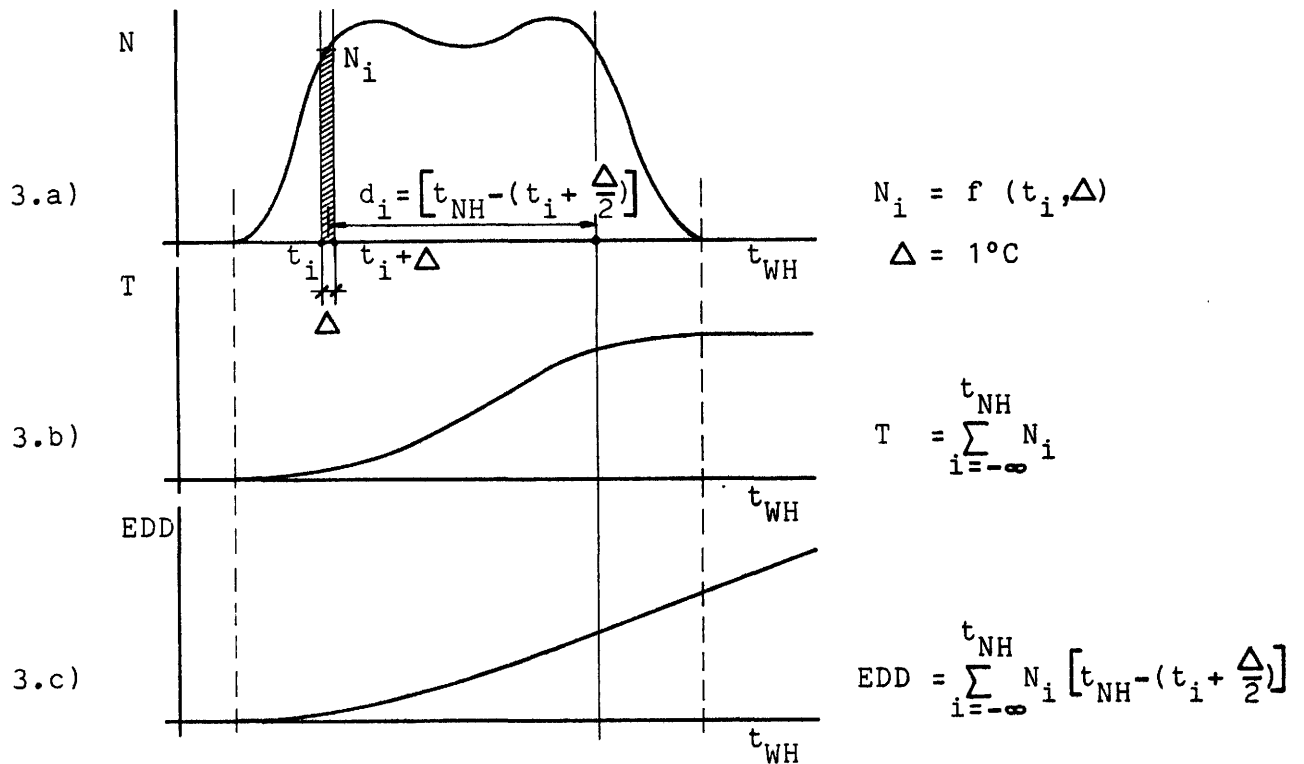

Figure 3.

In this peculiar case, we can calculate the length of the heating period by the use of equation (13) in its simplified form

$$T = \sum_{-\infty}^{t_{NH}} N_i \quad (15)$$

A diagrammatic representation of (15) is given in Figure 3.b. In the same way, the equivalent degree-day value (12) can be obtained directly from the following expression :

$$EDD = \sum_{-\infty}^{t_{NH}} N_i [t_{NH} - (t_i + \Delta / 2)] \quad (16)$$

And the corresponding representation appears in Figure 3.c.

e) Search for an analytical distribution of days

It becomes clear from the previous section (d) that the problem will be completely solved as soon as the distribution function is known. But, unhappily, this function is very difficult to build. From the definition of the temperature without heating,

$$t_{WH} = t_{ou} - Q_{sol}/K$$

From (6), we can write :

$$t_{WH} = t_{ou} - R_{cs} \cdot f(J)$$

and with Louis Laret's hypotheses (10)

$$t_{WH} = t_{ou} - \bar{R} \cdot J \quad (17)$$

In spite of its unpretentious appearance, this last equation is not easy to manage. It is not simply a statistical sum of independent events but a relation between two random correlated variables linked to the climate (t_{ou} , J) with one parameter also correlated (\bar{R}) linked to the building characteristics and also to the climate through the latitude and the type of climate.

So that we are fronted with three statistical distributions that are to be managed together. A satisfying approximation, in a first time, should be to consider three rectangular distributions characterized by :

$$\begin{aligned} & \bar{t}_{ou}, \Delta t_{ou} \\ & \bar{J}, \Delta J \\ & \bar{R}, \Delta (\bar{R} \cdot J) \end{aligned}$$

And finally, an analytical distribution of t_{WH} approaching the real one can be obtained from these three.

f) Conclusions

Of course the rough solution proposed here above is not to be considered as a final answer. It will be replaced by a statistical distribution based on a more realistic representation of the climate.

For example, assuming the climate to be stable, we can represent it by a cyclic function defined on a one year interval with an associated random noise. The deterministic part of this representation should be a sine curve.

This statistical model being based on the physical knowledge of the climate and not on empirical results, it gives extrapolation facilities. In particular the sum (17) can be calculated to obtain the distribution of t_{WH} . The remaining and cumbersome problem is to know the inter-correlation between t_{OU} and J . This kind of relation is not measured at the present time.

In the example developed here above, only one distribution has been selected that is the whole distribution on 25 years. When using this distribution, one computes the mean energy demand over a long period. But it is also possible to select different distributions according to other purposes. For instance : the maximum likelyhood year distribution, the extreme temperature year distribution at a given level of risk, and so on.

REFERENCES

- [1] "Temperature without heating of buildings", CEC Symposium, Brussels, May 1979.
- [2] BADOT J., LARET L., LEBRUN J., NUSGENS P., "Influence de certains paramètres sur la consommations de combustible", Final Report of IRSIA research work, Seneffe II, Nov. 1979, University of Liège, LPB-CSTC.
- [3] LARET L., "Etude de l'influence des paramètres d'isolation des bâtiments sur leur consommation de combustible. Température sans chauffage et modèles de rayonnement. Pertes par le sol. Modèles dynamiques simplifiés. Conditions climatiques extrêmes", Extract of the Final Report of IRSIA research work, Seneffe III, Nov. 1981, University of Liège, LPB-CSTC.
- [4] DUPAGNE A., CORNET M., HAUGLUSTAINE J.M., "Basic characteristics for low-cost houses in order to reduce the energy consumption for heating", Architectural Design Handbook, CEC Contract nr 615-78, Feb. 1981.
- [5] DOGNIAUX R., "Expositions énergétiques des parois orientées et inclinées par ciel serein", Institut Royal Météorologique de Belgique, Miscellanea Series B, nr 25, 26.
- [6] DELORME Y., LARET L., SOHET H., "Numerical predictions of thermal behaviour in dwelling structures", Université de Liège, Collection des Publications de la Faculté des Sciences Appliquées, n° 83, 1980.

6.3. Shading evaluation (written by J.B. Knowland)

The description of the development of shading factor concepts and their application is provided in full details in part 6 of the present final report.

This introduction will concentrate on evaluating their usefulness in the design process and in assessing future modifications of the subject.

As the effect of a shading device on the thermal balance of a building is practically impossible to measure directly, most energy consumption models add it in as an after-the-fact coefficient. These coefficients are generally imperically derived, rule-of-thumb type modifications, which may or may not be applicable to the specific situation. It was in response to this that a rational method of shading evaluation was developed.

a) Incorporation into Design Methodology

The appropriate use of shading factors can best be shown in flow chart form as in figure 1. Once the recuperation factor of the building is known, it can be tested against pre-set criteria, such as summer overheating risk and adequate winter free gains. If the recuperation factor is not satisfactory, modification by means of shading devices is considered. If shading devices are to be considered, the shading factors are calculated. The initial recuperation factor is then modified by the shading factors, and then there is a loop back until a satisfactory solution is found.

b) Use with manual methodology

As the calculation of the average shading factors themselves is a long and tedious process, it is not practical to use the described methods for load calculations.

An attempt was made to transformation and regression analysis on a large number of shading factors for two reasons. One purpose was to discern a pattern which would be useful for predicting other shading factors using simplified calculations. The second reason was to develop a simplified procedure requiring only the Fourier transformation coefficients to reproduce the original shading factors. This second possibility seemed especially promising due to the periodic nature of the shading factor curve.

However, an analysis of the shading factors proved unsuccessful as far as fulfilling either of the above purposes. For the first, although there are clearly discernable patterns, the complex interaction of solar angles, solar intensities in both the beam and diffuse regimes and the variety of shading devices possible led to results that were little better than the rule-of-thumb type coefficients already in use.

For the second purpose, although a table of Fourier transformation coefficients could reproduce the shading factors adequately, its use in conceptually seeing the effect of a shading device was severely limited by the need for involved calculations.

Therefore, the recommended procedure for including shading factors in a manual calculation method is to produce a sufficient number of graphs which would be applicable for the most commonly encountered situation. Although these graphs cannot possibly cover all specific designs, by careful inspection, the designer can easily discern the general trends and, with judicious interpolation, arrive at a shading device solution which is within the bands of accuracy and simplicity of most manual methods.

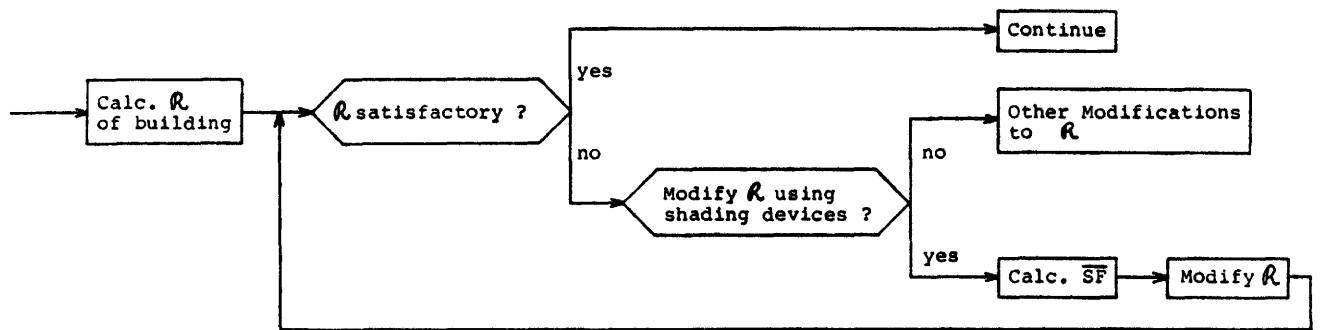

Fig. 1 : Schematic flow chart showing integration of shading factors into design methodology.

c) Incorporation of shading factors into computerized methodology (LPB-MASK)

The first effect undertaken was extensive analysis of a large number of shading factors. The two reasons for this analysis were (i) for prediction of other shading factors by extrapolation from recognizable patterns, and (ii) for reduction in the quantity of data necessary for reproducing the shading factor curves. Again, the complex interaction of the various parameters rendered this effort futile.

Parametric studies showed the model was most sensitive to the shape of the daily solar radiation profiles of the ratios

$$\frac{I_{\text{beam } i}}{I_{\text{total } i}} \quad \text{and} \quad \frac{I_{\text{diffuse } i}}{I_{\text{total } i}}, \quad \text{for } i = \text{hour } 1 \text{ to } 24.$$

In the winter months, when beam radiation is allowed to fall on the window, the ratio of $I_{\text{beam } i}/I_{\text{total } i}$ predominates. In the summer months, when due to the higher solar angles, the window is shaded from beam radiation, the diffuse sky radiation, in conjunction with the diffuse radiation view factor, is predominate. The contribution of diffuse ground radiation is approximately one order of magnitude less than that of diffuse sky radiation, unless there is a highly reflective ground cover.

Some other short conclusions can also be drawn from these studies :

- Vertical fins placed beside the windows are not as effective at modifying the recuperation factor as thought.
- The effectiveness of a horizontal overhang can be greatly enhanced by extending it beyond the width of the window, especially for windows that do not face directly South. The length of the extension can be conceptually expressed as :

Ext. length = $f(\text{orientation, North lat., } R)$.

- Reveals, that is a combination of vertical fins and horizontal overhangs, provide the most satisfactory modifications to the recuperation factor. Reveals will also decrease the exterior convective heat transfer coefficient of the window by reducing wind velocity across the window. They do, however, tend to restrict the view from within the room to the exterior.
- The most important conclusion to bear in mind, especially when trying to simplify the methodology is that, although it is possible to develop a few quick "rules-of-thumb" (i.e. an overhang should have a length of about 0.5 the height of the window for 51° North latitude), one must realize that the shading factor is a modifier of the recuperation factor. Therefore, such rules-of-thumb will only be applicable to buildings with similar recuperation factor profiles.

d) Future work on LPB-MASK

There are still three major areas of future work which should be carried out in the research of shading devices.

Sky-type models

At present, all of the available programs use the ASHRAE Clear Sky Model, as described in the Handbook of Fundamentals. This model may be modified for climates other than those found in the U.S. by the methods found in Ref. [1]. As mentioned previously, parametric studies show the model to be very sensitive to changes in daily solar radiation profile, that is, the model is much more sensitive to the relative shape of the daily curve than it is to the actual values used at each hour. It is also very sensitive to the ratio of beam to diffuse radiation.

To develop a realistic model, it would be necessary to draw heavily on actual climatic data for these profiles, beginning with that given by the "36-day-year" data. In the 36-day-year, the frequency of each sky type (clear sky, mean sky and overcast sky) and the intensities of diffuse and beam radiation are given on a daily basis. Further climatic data is necessary to derive hourly values for the slopes of total, beam, and diffuse radiation curves, as shown in figure 2. From this, the hourly ratios

$$\left(\frac{I_{b i}}{I_{\text{tot } i}}\right)_{\text{cs}} ; \left(\frac{I_{b i}}{I_{\text{tot } i}}\right)_{\text{ms}} ; \left(\frac{I_{b i}}{I_{\text{tot } i}}\right)_{\text{os}}$$

and

$$\left(\frac{I_{d i}}{I_{\text{tot } i}}\right)_{\text{cs}} ; \left(\frac{I_{d i}}{I_{\text{tot } i}}\right)_{\text{ms}} ; \left(\frac{I_{d i}}{I_{\text{tot } i}}\right)_{\text{os}}$$

could be applied, using the frequency of each sky type, to give a mean average shading factor.

Diffuse radiation view factors

In the present version of LPB-MASK, the diffuse radiation view factors must be pre-calculated and entered for each window configuration. This fault is due to the limited memory capacity and the poor file handling capabilities of the computer used. This fault could easily be overcome by adding the appropriate view factor mathematics algorithms as a sub-program. The diffuse view factors could then be determined either by direct calculation or by reference to a stored array.

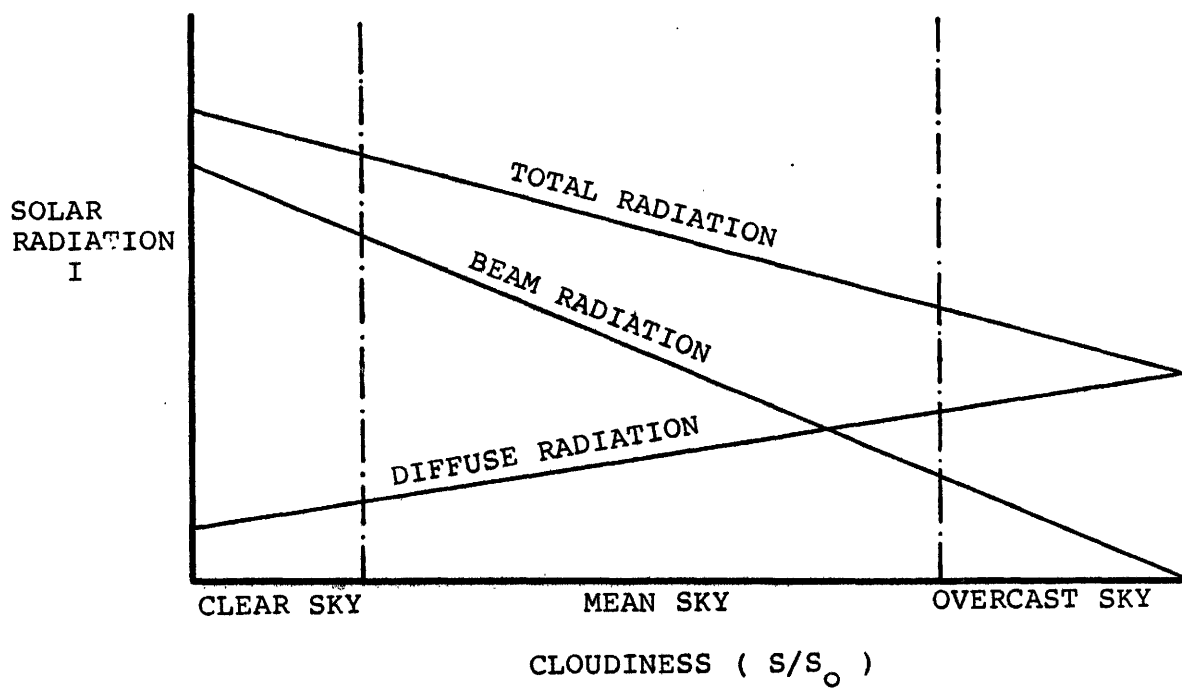

Fig. 2 : Typical hourly radiation profile for 3 different sky types.

Other shading devices

There are a much wider variety of shading devices possible than the three already modeled. The next most common one is a horizontal bar suspended apart from the glazing. Again, the limited memory of the computer used prevented the modeling of this type of shading. The main cause of the memory overload was the need to calculate twice as many points as with other shading devices. Again, this problem could easily be solved with the use of a more advanced computer.

Other types of shading devices which could be modeled would include more complex configuration of horizontal and vertical elements, irregular shaped shading devices, and shading caused by the building configuration.

Input-output operations

As with all computer applications, it is the user's needs and abilities which shape the eventual program. One of the main difficulties in architectural design programs is the need to define the geometrics of the problem at hand and its present configuration. LPB-MASK shares this problem with most other architectural programs.

The current version of LPB-MASK is a compromise, due to limited computer memory, between calculation and window/shading device geometry input. As it was meant primarily to be a research program rather than a user-oriented program, it favors computation over user ease. The use of screen graphics to construct and check the geometric configuration of the window/shading device would make data input much simpler, but would greatly reduce the computational abilities of the program. The shading sub-program used for LPB-1 is a good example of this problem. In this sub-program, the windows/shading device geometry is displayed on the screen, but the program is only able to calculate the shaded area for one hour of one day.

Clearly it will be the eventual user who must decide on the compromise between computational power and ease of input/output operations. The extent of the compromise necessary will obviously be strongly influenced by the computer system used as well.

REFERENCES

- [1] POWELL G.L., The ASHRAE Clear Sky Model, An Evaluation, Ashrae Journal, Nov. 1982.

7. Content description of the whole final report

The final report is composed of six separated parts. The present one being only the synthesis of the whole.

Part 3 can be obtained from the

"Centre Scientifique et Technique de la Construction",
Rue du Lombard, 41
B - 1000 BRUSSELS (Belgium)
with mention : BBRI. Devl. n° 4153.

Parts 2, 4, 5, 6 are to be ordered at the

"Laboratoire de Physique du Bâtiment"
Université de Liège
Avenue des Tilleuls, 15
B - 4000 LIEGE (Belgium).

Final Report, part 2**ARCHITECTURAL DESIGN : a case study****TABLE OF CONTENTS**

1. Settlement layout
2. Wind influence on town-planning layout
 - 2.1. References
3. Use of stereographic sun-path diagrams during the settlement layout
 - 3.1. General considerations and construction of the sun-path diagram of Marchin's latitude
 - 3.2. Introduction of energetical considerations
 - 3.3. Practical applications
 - 3.4. References
4. Feasibility study
 - 4.1. Space allocation
 - 4.2. Study of the shape factor : F_s
 - 4.3. Heating energy needs calculations for the proposed designs : chosen hypothesis
 - 4.4. Global heat loss coefficient calculation
 - 4.5. Heating energy needs calculation
 - 4.6. Global comparison of the four evaluation methods
 - 4.7. References
5. Outline proposals
 - 5.1. Proposed designs
 - 5.2. Hypotheses of calculations
 - 5.3. Comparison of the results obtained with the group of 12 houses
 - 5.4. References
 - 5.5. Annex : drawings of designs and worksheets of calculations
6. Detailed design
 - 6.1. Fenestration of the South facade
 - 6.2. Fenestration of the North facade
 - 6.3. Choice of the exterior wall type
 - 6.4. Dimensioning of the insulating layers by the LPB-4 programme
 - 6.5. Design of external window frames
 - 6.6. References
7. Report on the superintendence of the building works in Marchin
 - 7.1. Masonry works
 - 7.2. Remarks concerning the insulation placing
 - 7.3. Problems related to ventilation losses

Final Report, part 3**COMPLETION INSPECTION TECHNIQUES (energy aspects)****TABLE OF CONTENTS**

1. Introduction	1
2. Description of the house	1
3. Description of the different actions undertaken	2
4. Analysis of the different actions	3
4.1. Detailed monitoring of the houses (coheating)	3
4.1.1. Different heating systems	
4.1.2. Analysis of the climatological data	
4.1.3. Analysis of the consumption	
4.2. Determination of the in situ U-value of the external wall	29
4.2.1. Introduction	
a) a classical calculation	
b) measurement techniques	
4.2.2. Results for the measured wall	
4.3. Tracer gas measurements	35
4.4. Pressurisation tests	41
5. Conclusions	51
6. References	53

Final Report, part 4**MONITORING OF MARCHIN HOUSES****TABLE OF CONTENTS**

1. Introduction
2. Methodology of experimentation
 - 2.1. Process of interpretative observation
 - 2.2. Interfacing of data acquisition elements
 - 2.3. Audit and monitoring
3. Design of the monitoring in the Marchin project
 - 3.1. Probes and logging procedure
 - 3.2. Data processing
 - 3.3. A priori experimentation
4. Monitoring on the field
 - 4.1. Probes and logging procedure
 - 4.2. Data processing
 - 4.3. Methodological aspect of information processing
 - 4.4. Experimentation on the field.
5. Discussion of the results
6. Conclusion
7. References

Annex A

Probe wiring and nomenclature.

Annex B

Main results of monitoring.

- B.1. Reference temperatures.
- B.2. Indoor-outdoor temperatures.
- B.3. Outdoor climate.
- B.4. Energy measurements.
- B.5. Zoning effects between floors.
- B.6. Zoning effects in each floor.
- B.7. Homogeneity inside each room.

Final Report, part 5

COMPUTER AIDED DESIGN METHOD : USER'S GUIDE

TABLE OF CONTENTS

Foreword	
1. Introduction	1
References	8
2. Feasibility study	9
2.0. Main menu	26
2.1. Sensitivity study of K" and E" to main global factors	29
2.1.1. Organigram	29
2.1.2. Parameters	33
2.1.3. Default values	53
2.1.4. Results	57
2.1.5. Examples	59
2.2. Sensitivity study of the shape factor (for one house)	68
2.2.1. Organigram	68
2.2.2. Parameters	70
2.2.3. Default values	83
2.2.4. Results	84
2.2.5. Examples	85
2.3. Glazing and opaque characteristics	93
2.3.1. Organigram	93
2.3.2. Parameters	96
2.3.3. Default values	107
2.3.4. Results	108
2.3.5. Examples	109
2.4. Annexes	126
2.4.1. Shape factor calculation	126
2.4.2. Calculation of KRo	134
References	139

Final Report, part 6**NEW DEVELOPMENT IN CALCULATION METHODS****TABLE OF CONTENTS**

1. Dynamic modelling
 - 1.1. Some comments on concept of simplified dynamic modelling of building thermal behaviour.
Louis LARET.
 - 1.2. Simplified method for the determination of room air temperature in summer time and the intermittence efficiency.
Max CORNET.

2. Degree-day methodology
 - 2.1. Degree-day methodology : new development and sensitivity analysis.
Louis LARET.
 - 2.2. New development of equivalent degree-day methods.
Louis LARET.

3. Shading evaluation
 - 3.1. Development of the shading factor for determine the effectiveness of shading devices.
John B. KNOWLAND.
 - 3.2. Six computer programs for the calculation of shading factors (SF); a user's manual.
John B. KNOWLAND.