

KOMMISSIONEN FOR DE EUROPÆISKE FÆLLESSKABER
KOMMISSION DER EUROPÄISCHEN GEMEINSCHAFTEN
COMMISSION OF THE EUROPEAN COMMUNITIES
COMMISSION DES COMMUNAUTÉS EUROPÉENNES
COMMISSIONE DELLE COMUNITÀ EUROPEE
COMMISSIE VAN DE EUROPESE GEMEENSCHAPPEN

EURATOM

Årsberetning 1973

PROGRAM BIOLOGI - SUNDHEDSBESKYTTELSE

Jahresbericht 1973

PROGRAMM BIOLOGIE - GESUNDHEITSSCHUTZ

Annual Report 1973

PROGRAMME BIOLOGY - HEALTH PROTECTION

Rapport Annuel 1973

PROGRAMME BIOLOGIE - PROTECTION SANITAIRE

Relazione Annuale 1973

PROGRAMMA BIOLOGIA - PROTEZIONE SANITARIA

Jaarverslag 1973

PROGRAMMA BIOLOGIE - GEZONDHEIDSBESCHERMING

KOMMISSIONEN FOR DE EUROPÆISKE FÆLLESSKABER
KOMMISSION DER EUROPÄISCHEN GEMEINSCHAFTEN
COMMISSION OF THE EUROPEAN COMMUNITIES
COMMISSION DES COMMUNAUTÉS EUROPÉENNES
COMMISSIONE DELLE COMUNITÀ EUROPEE
COMMISSIE VAN DE EUROPESE GEMEENSCHAPPEN

EURATOM

Årsberetning 1973

PROGRAM BIOLOGI - SUNDHEDSBESKYTTELSE

Jahresbericht 1973

PROGRAMM BIOLOGIE - GESUNDHEITSSCHUTZ

Annual Report 1973

PROGRAMME BIOLOGY - HEALTH PROTECTION

Rapport Annuel 1973

PROGRAMME BIOLOGIE - PROTECTION SANITAIRE

Relazione Annuale 1973

PROGRAMMA BIOLOGIA - PROTEZIONE SANITARIA

Jaarverslag 1973

PROGRAMMA BIOLOGIE - GEZONDHEIDSBESCHERMING

EUR 5138 d-e-f-i-n

The annual reports in this volume were prepared under the responsibility of the heads of the research teams, set up under the various contracts, and were submitted in this form to the Commission and its contractual partners.

LEGAL NOTICE

The Commission of the European Communities is not responsible for the use which could be made of the following information

INHALTSVERZEICHNIS

TABLE OF CONTENTS

TABLE DES MATIERES

I. Einleitung/Introduction

- II. Mitglieder des Beratenden Programmausschusses
"Biologie - Gesundheitsschutz"
Members of the Advisory Committee on Programme
Management "Biology - Health Protection"
Membres du Comité Consultatif en matière de gestion
de programmes "Biologie - Protection Sanitaire"

III. Forschungstätigkeit Strahlenschutz
Research in Radiation Protection
Recherches en Radioprotection

1.	Dosimetrie/dosimetry/dosimétrie	3
101-BIOC	Dosimetry Group	5
"	TNO Rijswijk (Barendsen/Broerse)	7
"	Univ. Toulouse (Blanc)	11
"	GSF, Frankfurt (Pohlitz)	15
"	GSF, Neuherberg (Jacobi/Burger)	19
"	Univ. Strasbourg (Rechenmann)	23
"	Univ. Homburg (Muth/Grillmaier)	33
068-BIOI	CNEN, CSN Casaccia (Casnati)	41
065-PSTC	Personnel Dosimetry	49
"	CEA, CEN Fontenay-aux-Roses (Soudain)	51
"	CNEN, Bologna (Busuoli)	55
069-PSTF	Univ. Toulouse (Blanc)	67
065-PSTC	CEA, CEN Cadarache (Bricka)	71
"	KFA Jülich (Heinselmann)	83
"	GSF, Neuherberg (Wachsmann/Burger)	87
047-PSTC	Bundesforschungsanstalt für Lebensmittel- frischhaltung Karlsruhe (Diehl)	91
"	Instituut voor de Volksgezondheid, Bilthoven (Spaander/Strackee)	99
"	Institut d'Hygiène et d'Epidémiologie, Bruxelles (Lafontaine)	103
"	CENATRA, Antwerpen (Maes/Deschreider)	107
2.	Transport von Radionukliden/transport of radio- nuclides/cheminement des radionuclides	111
061-PSAF	CEA, CEN Fontenay-aux-Roses (Lacourly)	113
104-BIAI	CNEN, Fiascherino (Bernhard)	133
094-BIAN	ITAL, Wageningen (De Zeeuw)	149
s/c 10	Univ. Louvain (Laudelout)	185
096-BIOB	Univ. Louvain (Goffeau)	187

3.	Genetische Wirkungen/hereditary effects/ effets héréditaires	193
	102-BIAN TNO/RU Leiden (Rörsch)	195
	" TNO/RU Leiden (Sobels)	215
	" TNO/RU Leiden (Van der Eb)	249
	119-BIOE Univ. Swansea (Parry)	257
	111-BIOI Univ. Milano/Pisa (Magni/Loprieno)	273
	099-BIAB ULB Bruxelles (Brachet)	279
	097-BIOF INRA, Dijon (Dalebroux)	295
	112-BIOI Univ. Pavia (Fraccaro)	307
4.	Kurzzeitwirkungen/short-term effects/ effets à court terme	311
	088-BIAC EORTC	313
	" Inst.C.Bernard, Villejuif (Mathé)	319
	" Ist.M.Negri, Milano (Garattini)	349
	" Univ. Ulm (Fliedner)	359
	" TNO, Rijswijk (Van Bekkum)	379
	" ULB Bruxelles (Tagnon)	385
	089-BIAD GSF, München (Thierfelder)	391
	108-BIOI CNEN, CSN Casaccia (Doria)	397
	093-BIOB ULB Bruxelles (Dumont)	403
5.	Langzeitwirkungen/long-term effects/ effets à long terme	409
	095-BIOB CEN Mol (Maisin)	411
	090-BIAD GSF, Neuherberg (Gössner/Hug)	425
	063-PSTD DKFZ, Heidelberg (Scheer)	441
	100-BIAF CEA, CEN Fontenay-aux-Roses (Lafuma)	457
	062-PSTI ENEL, Torino (Farulla)	465
	092-BIOC EULEP	469
	091-BIOC ICRP	487
6.	Gruppe Biologie Ispra/biology group Ispra/ groupe de biologie Ispra	491
IV.	Forschungstätigkeit Anwendungen Landwirtschaft Research on Applications in Agriculture Recherches relatives aux Applications agronomiques	513
1.	ITAL und Unterverträge/ITAL and its subcontracts/ ITAL et sous-contrats	515
	094-BIAN ITAL, Wageningen (De Zeeuw)	517
	s/c 1 Univ. Strasbourg (Rechenmann)	609
	s/c 2 Univ. Nijmegen (Linskens)	617
	s/c 3 I.V.P., Wageningen (Sneep)	623
	s/c 4 CNEN, CSN Casaccia (Bossini)	635
	s/c 5 I.S.C., Roma (Bianchi)	647
	s/c 6 Univ. Bari (Scarascia-Mugnozza)	651
	s/c 7 Univ. Bonn (Gottschalk)	655
	s/c 8 GSF, Grünbach (Gaul)	665
	s/c 9 GSF, Hannover (Kühn)	677
	s/c11 Univ. Modena (Carafoli)	685

2.	Zellkulturen/cell culture/culture de cellules	687
	106-BIOI Univ. Pisa (D'Amato)	689
	117-BIOD FU Berlin (Reinert)	693
	107-BIOI CNEN, CSN Casaccia (Bozzini)	699
	118-BIOD GSF, Grünbach (Gaul)	711
3.	Radioentomologie/radioentomology/radioentomologie	715
	114-BIOD BLA Bodenkultur, München (Haisch)	717
	105-BIOI Univ. Padova (Zangheri)	721
	115-BIOD Univ. Mainz (Laven)	739
	098-BION I.P.O., Wageningen (Ticheler)	743
	107-BIOI CNEN, CSN Casaccia (Bozzini)	753
V.	Forschungstätigkeit Anwendungen Medizin Research on Applications in Medicine Recherches relatives aux Applications médicales	759
1.	Nuklearmedizin/nuclear medicine/médecine nucléaire	761
	116-BIOD Univ. Ulm (Adam)	763
	110-BIOI Univ. Pisa (Donato)	769
	089-BIAD GSF, München (Thierfelder)	787
2.	Neutronendosimetrie/neutron dosimetry/ dosimétrie des neutrons	797
	113-BIOC GSF, Neuherberg (Burger)	799
	" GSF, Frankfurt (Pohlit)	803
	" M.R.C., London (Vonberg/Bewley)	809
	" TNO, Rijswijk (Broerse)	813
	" Neutron Intercomparison Project/ ICRU (Wyckoff)	817
VI.	Koordinierungstätigkeit Coordination Activités de coordination	819

Tre nye stater er blevet medlemmer af De europæiske Fællesskaber fra 1. januar 1973. Derfor har det været nødvendigt at tilpasse programmet "Biologi - sundhedsbeskyttelse" for 1971-1975 til den nye situation. Kommissionen foreslog Ministerrådet at føre programmet videre uden at ændre dets målsætning, idet der gradvis sikres deltagelse fra visse laboratorier i de nye medlemsstater. Rådet accepterede dette forslag den 14. maj 1973. Fra det øjeblik begyndte en detaljeret forberedelse af fælles projekter, som har givet anledning til mangfoldige kontakter, til besøg og til møder. I november 1973 var den rådgivende forvaltningskomité for programmet "Biologi - sundhedsbeskyttelse" i stand til at fremkomme med en udtalelse om de kontraktforslag, som var forelagt for den af Kommissionens tjenestegrene, og kunne således fastlægge arbejdsplanen for de 2 kommende år. Vi takker den rådgivende komité's medlemmer for det betydelige arbejde, de har udført ved denne lejlighed, og for den konstruktive måde hvorpå de har angrebet de indviklede problemer, som blev forelagt dem.

For så vidt angår selve programmet er det værd at erindre, at det består af et afsnit benævnt "strålingsbeskyttelse" (fællesprogram) og et afsnit benævnt "anvendelser" (supplerende program), hvis forskningsområder og hvis mål kan skitseres som følger:

1. Måling og vurdering af den ioniserende stråling, som mennesket og forskellige dele af omgivelserne udsættes for:
 - dosimetri, strålingsmåling og fortolkning af måleresultaterne;
 - undersøgelse af transporten og ophobningen af radionukleider i mennesket og i omgivelsernes bestanddele.

2. Den ioniserende strålings vekselvirkning med de biologiske systemer:
 - strålingens primærvirkninger
 - virkninger på arveanlæggene
 - korttidsvirkninger
 - langtidsvirkninger.

3. Anvendelser af nuklear teknologi inden for visse vigtige sektorer i den landbrugsvidenskabelige og den medicinske forskning.

Dette dokument præsenterer "standpunktsrapporterne" for de enkelte projekter inden for det kontraktmæssige program og for biologigruppen i Ispra.

F. VAN HOECK

P. RECHT

Seit dem 1. Januar 1973 gehören den Europäischen Gemeinschaften drei neue Mitgliedstaaten an. Das Programm "Biologie - Gesundheitsschutz" 1971-1975 mußte deshalb diesem neuen Sachverhalt Rechnung tragen. Die Kommission hat dem Ministerrat vorgeschlagen, das Programm so anzupassen, daß die zunehmende Beteiligung von Laboratorien der neuen Mitgliedstaaten gewährleistet ist, ohne die Richtlinien des Programms zu ändern. Der Rat hat diesen Vorschlag am 14. Mai 1973 angenommen. Seither ist mit der eingehenden Vorbereitung von Projekten für eine Zusammenarbeit begonnen worden, und es haben zahlreiche Kontakte, Besuche und Zusammenkünfte stattgefunden. Im November 1973 konnte der Beratende Programmausschuß "Biologie - Gesundheitsschutz" eine Stellungnahme zu den Vertragsvorschlägen abgeben, die ihm von den Dienststellen der Kommission vorgelegt worden waren, und auf diese Weise ist ein Aktionsplan für die nächsten zwei Jahre festgelegt worden. Unser Dank gilt den Mitgliedern des Beratenden Programmausschusses für die hierbei von ihnen geleistete beträchtliche Arbeit und für die konstruktive Art und Weise, wie sie die ihnen vorgelegten komplexen Probleme in Angriff genommen haben.

Was das Programm selbst betrifft, so sei bemerkt, daß es einen Abschnitt "Strahlenschutz" (gemeinsames Programm) und einen Abschnitt "Anwendungen" (Ergänzungsprogramm) umfaßt, deren Forschungsbereiche und Ziele nach folgendem Schema dargestellt werden können:

1. Messung und Bewertung der Belastung des Menschen und seiner Umwelt durch ionisierende Strahlungen:
 - Dosimetrie, Strahlenmessung und ihre Interpretation;
 - Untersuchung des Transports und der Anreicherung der Radionuklide im Menschen und in seiner Umwelt.

2. Wechselwirkung der ionisierenden Strahlungen mit den biologischen Systemen:
 - Primärwirkungen der Strahlungen
 - Wirkungen auf das Erbgut
 - Kurzzeitwirkungen
 - Langzeitwirkungen.

3. Anwendungen der nuklearen Techniken auf bestimmte wichtige Sektoren der agronomischen und medizinischen Forschung.

Das vorliegende Dokument enthält die "Berichte über den Fortgang der Arbeiten" an den einzelnen Projekten des Vertragsprogramms und die Berichte der Gruppe Biologie Ispra.

F. VAN HOECK

P. RECHT

INTRODUCTION



On 1 January 1973, three new states became members of the European Communities. Consequently the 1971-1975 programme "Biology - Health Protection" had to be adapted to the new situation. The Commission proposed to the Council of Ministers that the programme should be adjusted without altering the guidelines, to enable various laboratories of the new Member States to join in it step by step. The Council accepted this proposal on 14 May 1973. The planning of detailed cooperation projects began at once, giving rise to a number of contacts, visits and meetings. In November 1973, the Advisory Committee on Programme Management "Biology - Health Protection" was in a position to give an opinion on the contract proposals submitted to it by the Commission and thus defined the plan of action for the next two years. We would like to thank the members of the Advisory Committee for the considerable amount of work they carried out at this time and for the constructive way in which they dealt with the difficult problems presented to them.

With regard to the programme itself, it should be mentioned that it includes a "Radiation Protection" (common programme) sector and an "Applications" (supplementary programme) sector whose fields of research and objectives can be outlined as follows:

1. Measurement and evaluation of the exposure of man and the various components of the ambient environment to ionizing radiation:
 - dosimetry, radiation measurements and their interpretation;
 - study of the transfer and accumulation of radionuclides in man and in the constituents of the environment.

2. Interaction of ionizing radiations with biological systems:
 - primary effects of radiation;
 - effects on hereditary material;
 - short-term effects;
 - long-term effects.

3. Application of nuclear techniques in certain important sectors of agricultural and medical research.

This document presents the "progress reports" for each project of the contractual programme and of the Biology Group Ispra.

F. VAN HOECK

P. RECHT

INTRODUCTION

F

Trois nouveaux Etats sont devenus membres des Communautés européennes en date du 1er janvier 1973. De ce fait, le programme 1971 - 1975 "Biologie - Protection sanitaire" a dû être adapté à la situation nouvelle. La Commission a proposé au Conseil de Ministres d'aménager le programme sans modifier ses orientations, et en y assurant la participation de certains laboratoires des nouveaux Etats membres d'une manière progressive. Le Conseil a accepté cette proposition le 14 mai 1973. Dès ce moment, une préparation détaillée de projets de collaboration a commencé, et a donné lieu à de multiples contacts, à des visites et à des réunions. En novembre 1973, le Comité consultatif en matière de gestion de programmes "Biologie - Protection sanitaire", a été en mesure de donner un avis sur les propositions de contrat qui lui étaient soumises par les services de la Commission, et a ainsi défini le plan d'action pour les 2 années à venir. Nous remercions les membres du Comité consultatif pour le travail considérable qu'ils ont accompli à cette occasion et pour la manière constructive avec laquelle ils ont abordé les problèmes complexes qui leur étaient soumis.

En ce qui concerne le programme lui-même, il convient de rappeler qu'il comporte un secteur "Radioprotection" (programme commun) et un secteur "Applications" (programme complémentaire) dont les domaines de recherche et les objectifs peuvent être schématisés comme suit:

1. Mesure et évaluation de l'exposition de l'homme et des diverses composantes du milieu ambiant aux rayonnements ionisants:
 - dosimétrie, mesure des rayonnements et leur interprétation;
 - étude du transfert et de l'accumulation des radionucléides dans l'homme et dans les éléments du milieu.

2. Interaction des rayonnements ionisants avec les systèmes biologiques:

- effets primaires des rayonnements
- effets sur le matériel héréditaire
- effets à court terme
- effets à long terme.

3. Applications des techniques nucléaires à certains secteurs importants de la recherche agronomique et médicale.

Le présent document présente les "rapports d'avancement" par projet individuel du programme contractuel et du groupe de Biologie installé à Ispra.

F. VAN HOECK

P. RECHT

INTRODUZIONE

Dal 1° gennaio 1973 conta la Comunità europea tre nuovi Stati membri. Di conseguenza il programma 1971-1975 "Biologia - Protezione sanitaria" ha dovuto subire delle modifiche per essere adattato alla nuova situazione. La Commissione ha proposto al Consiglio dei Ministri di adeguare il programma senza modificarne gli orientamenti, assicurando progressivamente la partecipazione ad esso di alcuni laboratori dei nuovi Stati membri. Il 14 maggio 1973 il Consiglio ha approvato tale proposta. E' cominciata allora la preparazione dettagliata dei progetti di collaborazione; sono stati presi molteplici contatti e sono state effettuate visite e riunioni. Nel novembre 1973 il Comitato consultivo in materia di gestione dei programmi "Biologia - Protezione sanitaria" ha potuto esprimere un parere sulle proposte di contratti presentate gli dai Servizi della Commissione e ha fissato il piano d'azione per i prossimi due anni. Ringraziamo i membri del Comitato consultivo per il notevole lavoro da essi svolto in questa occasione e per la maniera costruttiva con cui hanno affrontato i complessi problemi che sono stati loro sottoposti.

Circa il programma, si ricorda che esso comporta una sezione "Radioprotezione" (programma comune) e una sezione "Applicazioni" (programma complementare), i cui settori di ricerca e gli obiettivi possono essere schematizzati nel modo seguente :

1. Misura e valutazione dell'esposizione dell'uomo e dei vari componenti dell'ambiente alle radiazioni ionizzanti :
 - dosimetria, misura delle radiazioni e interpretazione dei risultati;
 - studio del passaggio e dell'accumulazione dei radionuclidi nell'uomo e negli elementi dell'ambiente.

2. Interazione delle radiazioni ionizzanti con i sistemi biologici :

- effetti primari delle radiazioni
- effetti sul materiale ereditario
- effetti a breve termine
- effetti a lungo termine.

3. Applicazione delle tecniche nucleari in alcuni importanti settori della ricerca agronomica e medica.

Il presente documento contiene le relazioni sull'avanzamento dei singoli progetti del programma contrattuale e del Gruppo di Biologia con sede ad Ispra.

F. VAN HOECK.

P. RECHI.

Op 1 januari 1973, zijn drie landen toegetreden tot de Europese Gemeenschappen. In verband hiermede moest het programma "Biologie - Bescherming van de gezondheid" 1971 - 1975 worden aangepast aan de nieuwe situatie. De Commissie heeft de Raad van Ministers voorgesteld het programma aan te passen zonder wijziging te brengen in de strekking en een aantal laboratoria uit de nieuwe lid-staten hierbij geleidelijk te betrekken. De Raad heeft dit voorstel op 14 mei 1973 aanvaard. Vanaf dat tijdstip is een begin gemaakt met een gedetailleerde voorbereiding van de samenwerkingsprojecten en talrijke contacten zijn gelegd en bezoeken en vergaderingen hebben plaatsgevonden. In november 1973, kon het Raadgevend Comité voor het programmabeheer "Biologie - Bescherming van de gezondheid" een advies uitbrengen over de contractvoorstellen van de diensten van de Commissie, waarbij een actieprogramma voor de volgende twee jaar werd vastgelegd. De leden van het Raadgevend Comité komt dank toe voor de omvangrijke werkzaamheden die zij hierbij hebben verzet en voor de constructieve wijze waarop zij de complexe vraagstukken waarvoor zij gesteld waren hebben aangepakt.

Wat het programme zelf betreft, kan erop worden gewezen dat dit een afdeling "Stralingsbescherming" (gemeenschappelijk programma) omvat en een onderdeel "Toepassingen" (aanvullend programma) waarvan de gebieden en doelstellingen als volgt in een schema kunnen worden samengevat :

1. Meting en evaluatie van de blootstelling van de mens en de verschillende componenten van het omgevingsmilieu aan ioniserende straling :
 - dosimetrie, stralingsmeting en interpretatie van de meetresultaten;
 - studie van de overdracht en accumulatie van de radionucliden bij de mens en bij de milieucomponenten.

2. Wisselwerking tussen ioniserende straling en biologische systemen :

- primaire stralingseffecten
- effecten op erfelijk materiaal
- effecten op korte termijn
- effecten op lange termijn.

3. Toepassingen van kerntechnieken op een aantal belangrijke sectoren van het agronomisch en medisch onderzoek.

In dit document zijn de werkverslagen opgenomen van alle afzonderlijke projecten van het programma op contract en van de te Ispra gevestigde groep Biologie.

F. VAN HOECK

P. RECHT

Mitglieder im Jahr 1973 des Beratenden Programmausschusses
"BIOLOGIE - GESUNDHEITSSCHUTZ"

Members in 1973 of the Advisory Committee on Programme Management
"BIOLOGY - HEALTH PROTECTION"

Membres en 1973 du Comité Consultatif en matière de gestion de programmes
"BIOLOGIE - PROTECTION SANITAIRE"

BELGIQUE - BELGIE

M. ERRERA
A. LAFONTAINE
J.R. MAISIN

BUNDESREPUBLIK DEUTSCHLAND

W. GÖSSNER
H. MUTH, Vorsitzender
R. WITTENZELLNER

DANMARK

M. FABER
N.O. KJELDGAARD
J. SANDFAER
J.C. SIIM

FRANCE

M. BERGES
H. JAMMET
G. LACOURLY
P. LEONARDI

EIRE

W.J.E. JESSOP
J.W. HARMAN
A.W. MOORE
L.B. O'MOORE

ITALIA

E. CASNATI
A. CIGNA
G. SILINI

LUXEMBOURG

P. KAYSER

NEDERLAND

F.H. SOBELS
L. STRACKEE
D.W. VAN BEKKUM

UNITED KINGDOM

G.W. DOLPHIN
A.S. McLEAN
R.H. MOLE
E.E. POCHIN
N.G. STEWART

COMMISSION

A.J. BERTINCHAMPS
P. RECHT
F. VAN HOECK

Secrétariat (Commission):

H.G. EBERT
H. SCHIBILLA

III.

FORSCHUNGSTÄTIGKEIT STRAHLENSCHUTZ

RESEARCH IN RADIATION PROTECTION

RECHERCHES EN RADIOPROTECTION

STRAHMENMESSUNGEN UND IHRE INTERPRETATION (DOSIMETRIE)

MEASUREMENT AND INTERPRETATION OF RADIATION (DOSIMETRY)

MESURE DES RAYONNEMENTS ET LEUR INTERPRETATION (DOSIMETRIE)

Weitere Forschungsarbeiten zu diesem Thema werden auch in folgenden Jahresberichten beschrieben:

Further research work on these subjects will also be described in the following annual reports:

D'autres travaux sur ce thème de recherche sont également décrits dans les rapports annuels suivants:

092-BIOC	EULEP
094-BIAN	ITAL, Wageningen (De Zeeuw)
113-BIOC	GSF, Neuherberg (Burger)
"	GSF, Frankfurt (Pohlit)
"	M.R.C., London (Vonberg/Bewley)
"	TNO, Rijswijk (Broerse)
"	Neutron Intercomparison Project/ICRU

Biology Group Ispra

DOSIMETRY GROUP

Report 1973

1. The increasing importance of nuclear power and the widespread use, especially in medicine, of ionizing radiations and radiation sources have recently once more stimulated widespread discussions on the radiation risk and the protection of the population and its environment. Since long the study of hazards connected with radiation is the ultimate goal of the Biology - Health Protection Programme, and the Dosimetry Group tries to provide physical data and necessary services within this research programme.

In 1973 as in the previous year the Dosimetry Group has concentrated its collaborative efforts on three major subjects essential for risk estimation and for understanding the mechanisms of radiation effects:

- evaluation of the biological effectiveness of different types of radiation,
- energy transfer in biological material and model substances,
- radiation effects in condensed matter, its application and development of new dosimetric methods.

Furthermore activities on standardization and intercomparison have to be mentioned.

The Group held its regular meetings and members have participated in the various scientific congresses organized or co-sponsored by the Commission (see Annex VI) as e.g. the 4th Symposium on Microdosimetry held on 24-28 September 1973 (proceedings published as Euratom Report No EUR 5122).

2. Research units from the following institutes are members of the Dosimetry Group and are collaborating in this research programme:

- Radiobiological Institute TNO, Rijswijk¹⁾
- C.P.A., Université Paul Sabatier, Toulouse¹⁾
- GSF, Abtlg. für Biophysikalische Strahlenforschung, Frankfurt¹⁾
- GSF, Institut für Strahlenschutz, Neuherberg/München¹⁾
- L.B.R.M., Université Louis Pasteur, Strasbourg¹⁾
- Institut für Biophysik, Universität des Saarlandes, Homburg¹⁾
- CNEN, Lab. Dosimetria e Standardizzazione, Casaccia²⁾
- Institute of the Association EURATOM-ITAL, Wageningen³⁾
- Biology Group, CEC, Ispra⁴⁾

The results of their respective work in 1973 are outlined on the following pages.

3. Scientific correlation exists between the work of the Dosimetry Group and another group contract on neutron dosimetry and inter-comparison⁵⁾; the results of which are given later in the present report. Since the research programmes are complementary, and several institutes are collaborating in both of them, the exchange of information is assured at each level.

1) Contract No. 101-72-1 BIOC

2) Contract No. 068-67-6 BIOD

3) The report on the activities in dosimetry is incorporated in the annual report 1973 of contract No. 084-72-1 BIAN, ITAL Wageningen.

4) The report on the activities in dosimetry is incorporated in the annual report 1973 of the Biology Group, Ispra.

5) Contract No. 113-72-1 BIOC

Radiobiological Institute TNO, Rijswijk (ZH), The Netherlands

Contract No. 101-72-1 BIOC

G.W. Barendsen

Evaluation of the biological effectiveness of different types of radiation

Studies were performed of energy deposition distributions of alpha particles and fast neutrons in simulated tissue volumes with diameters of 0.1 - 5 μm of unit density material. The aim of these investigations is to correlate these spectra with observed differences in relative biological effectiveness for various effects in mammalian cells. These relationships are of interest for the evaluation of risks of low doses of radiation for radiation protection purposes and with regard to the prediction of possible advantages of high-LET radiation for the treatment of cancer.

Several factors have been analyzed which influence the pulse height spectra from tissue-equivalent proportional counters employed to measure energy deposition in small simulated volumes of tissue. This analysis has shown that with respect to detector characteristics, specific limitations exist which depend on the type of radiation measured.

Results of project No. 1

B. Hogeweg, G.W. Barendsen and J.J. Broerse

Evaluation of the biological effectiveness of different types of radiation

From data obtained earlier it was concluded that loss of the reproductive capacity of mammalian cells after irradiation with alpha particles is caused by deposition of a sufficiently large amount of energy in a critical structure or in regions of a critical structure, which have dimensions of 10-100 nm of unit density tissue.

The best method presently available for the measurement of event size distributions in small volumes is provided by the tissue-equivalent (TE) proportional counter, having a TE wall and TE gas filling.

Energy loss distributions for alpha particles passing through the sensitive volume of the cylindrical TE counter over chord lengths of 3.9 and 4.7 mm have been measured at gas pressures of 760, 160, 85, 40, 20, 10, and 5 Torr. These two trajectories are perpendicular to the central axis of the counter and pass at minimum distances of 1.7 and 3.1 mm from the central wire. From the spectra measured it was concluded that the ratio of the mean pulse heights of the distributions for gas pressures in excess of 40 Torr are within experimental errors equal to the ratio of the path lengths, i.e. 1.21 ± 0.06 . At 10 Torr, however, this ratio is equal to 1.00 ± 0.05 .

It can be concluded that, at gas pressures of less than about 20 Torr, which is equivalent to a simulated diameter of 0.15 μm of unit density tissue, the gas gain of the detector varies markedly with the position of the track. This phenomenon can be interpreted assuming that the density of the counter gas below this pressure is too low to allow sufficient collisions in the avalanche for electrons liberated close to the anode.

The implication of this result is that event size distributions for volumes of sizes less than 0.1 μm , which are of special interest for the interpretation of biological results, cannot be obtained from physical measurements with proportional counters.

The measurements of energy deposition spectra have been extended to the local energy distributions for 14 MeV neutrons at equivalent diameters of 5.6 and 1.2 μm . The neutrons have been produced by a 400 kV Van de Graaff electrostatic generator. The spectra have been measured with a 2" spherical

Rossi TE counter and with a cylindrical TE counter having an elongation factor of 2. Measured spectra for the two counters are presented in figures 1 and 2, respectively. The gas gain of the counters was of the order of 100. It has been shown that higher gas gain values will result in spectrum compression, probably due to space charge effects around the central wire of the counter for the high-LET particles, e.g. heavy recoils. The spectra from the two counters at equal simulated diameters show large differences in slope, especially in the regions corresponding to the Bragg peaks of the secondary particles. These differences between the two counters can be explained as being due partly to differences in the track length distributions for the particles in both counters.

The measurements of these event size distributions at smaller simulated diameters and for different neutron energies will be the subject for further investigations.

LIST OF PUBLICATIONS Contract No. 101-72-1 BIOC

- Hogeweg, B., Gas gain characteristics of a tissue-equivalent proportional counter, and their implications for measurements of event size distributions in small volumes. In: Proceedings of the 4th Symp. on Microdosimetry, Verbania Pallanza, Italy, 1973, in press.
- Barendsen, G.W., Relative biological effectiveness and biological complexity. *ibid.*

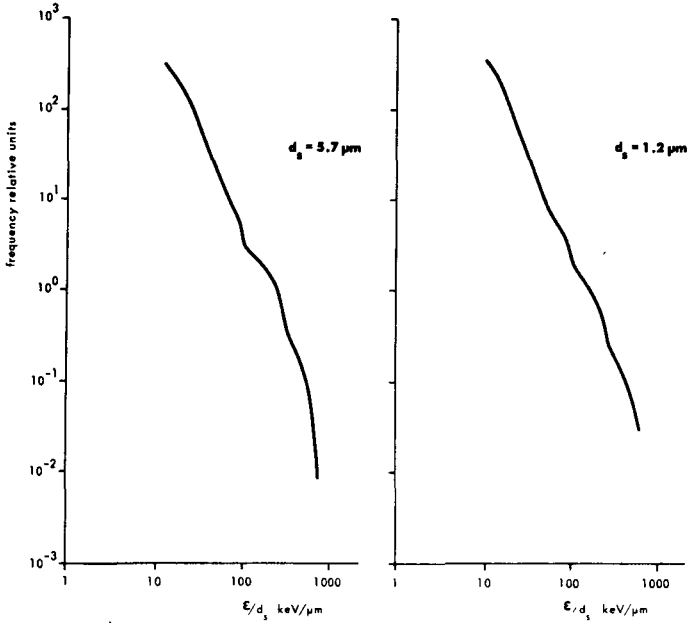

Figure 1. Event size spectra of 14 MeV neutrons measured with a 2'' Rossi tissue-equivalent proportional counter at simulated diameters of 5.7 and 1.2 μm of unit density tissue.

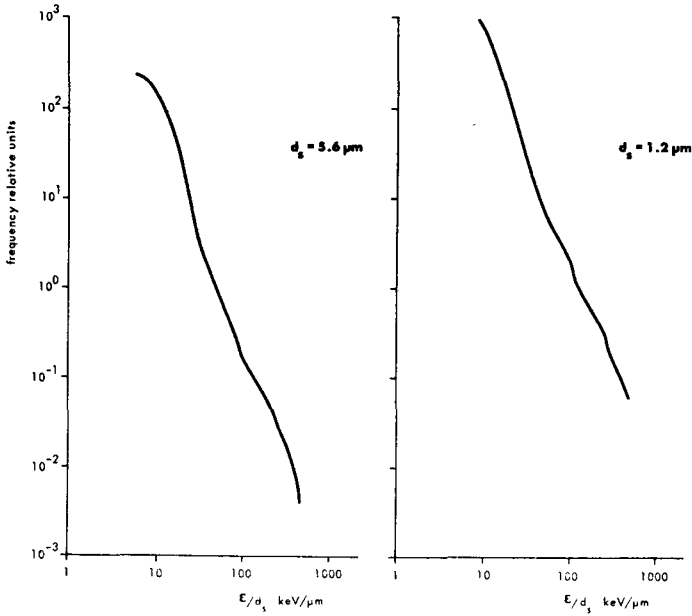

Figure 2. Event size spectra of 14 MeV neutrons measured with a cylindrical tissue-equivalent proportional counter at simulated diameters of 5.6 and 1.2 μm of unit density tissue.

Contractant de la Commission : Centre de Physique Atomique,
118, route de Narbonne
31077 TOULOUSE-CEDEX

N° du Contrat : 101-72-1 BIOC

Chef du groupe de recherche : D. BLANC

Thème général du contrat : Energy transfer in biological material and
in model substances.

We have simulated the 2 MeV electron transport into a semi infinite system with a spherical inclusion. The semi infinite and inclusion media composition may be the same or different. We can calculate all the microdosimetric quantities such as : Energy loss spectra into the inclusion and energy spectra of electrons crossing the inclusion surface, energy deposition, statistical distribution of energy deposition versus L. E. T. , and distributions of path lengths achieved into the inclusion.

In the low energy region we have simulated the one keV electron transport with use of an "interaction after interaction" method. The elastic and inelastics cross-sections used for this simulation were calculated following theoretical works and/or taken from experimental data. For the present we are study semi infinite media of low Z gases. Then we shall study organic media.

Résultats du projet n° 1

Chef du projet et collaborateurs scientifiques : J. P. PATAU,
M. TERRISSOL, M. MALBERT, M. TEP

Titre du projet : Simulation du transport des particules dans la matière par méthode de Monte-Carlo. Application à la dosimétrie.

Nous avons utilisé les méthodes de simulation mises au point précédemment (1) pour la recherche de diverses grandeurs microdosimétriques.

Nous avons étudié un milieu semi-infini dans lequel nous considérons une inclusion sphérique de petit diamètre (1 mm à 1 micron) et de composition identique ou différente de celle du milieu semi-infini. Ce dernier est irradié par un faisceau large d'électrons monoénergétiques de 2 MeV. Les compositions choisies pour le milieu semi-infini et pour l'inclusion sphérique sont : le tissu mou et (ou) le tissu osseux.

Les grandeurs que nous avons calculées sont : les spectres de longueur de parcours effectués par les électrons dans l'inclusion, les spectres énergétiques des électrons franchissant l'enveloppe sphérique, les spectres des pertes d'énergie et les spectres de T. L. E. de l'énergie absorbée dans l'inclusion (2). A partir des spectres de perte d'énergie, nous avons calculé le paramètre microdosimétrique défini par ROSSI (3). Nous présentons (figure 1) la variation de ζ (MeV/g elec.) en fonction du diamètre D (cm) d'une inclusion de tissu mou dans du tissu osseux.

Dans le domaine des basses énergies - inférieures à 1 keV - nous avons mis au point une méthode de simulation du transport des électrons au "coup par coup". Cette méthode consiste à simuler une par une les interactions élastiques ou inélastiques de l'électron incident avec les atomes du milieu ralentisseur. Les sections efficaces élastiques totales et différentielles ont été obtenues par intégration numérique de la section efficace de diffusion élastique non relativiste exacte des "déphasages" de MOTT.(4). Les sections efficaces inélastiques totales d'ionisation et d'excitation sont calculées avec le modèle de GRYZINSKI (5). L'accord du modèle de GRYZINSKI avec les résultats expérimentaux est bon pour l'hydrogène ; pour les autres corps nous ajustons le modèle de GRYZINSKI aux résultats expérimentaux existant. Les distributions de déflexions angulaires et de pertes d'énergie sont obtenues par échantillonnage des sections efficaces différentielles de VRIENS (6). Des indications plus précises ont été données au Congrès de PALLANZA (7). Nous avons simulé le transport d'électrons d'énergies initiales 1 keV et 0, 5 keV se ralentissant dans un milieu semi-infini d'hydrogène dans les conditions normales, le

faisceau d'électrons tombant perpendiculairement au plan délimitant le milieu. Le programme de calcul permet d'obtenir un grand nombre d'informations : sur la figure 2 nous pouvons voir par exemple les profils d'énergie déposée en profondeur. Actuellement nous étudions les autres corps d'intérêt biologique : C, N, O, d'abord d'un point de vue atomique puis ensuite moléculaire, en vue de l'étude des molécules organiques.

REFERENCES

- (1) PATAU (J. P.) : Thèse de doctorat ès-Sciences n° 478, Université Paul Sabatier, TOULOUSE - 1972.
- (2) PATAU (J. P.), MALBERT (M.), TERRISSOL (M.), COMMANAY (L.) "Etudes dosimétriques dans des cavités sphériques situées en un milieu semi-infini, irradié par des électrons de 2 MeV". Fourth Symposium on Microdosimetry, Pallanza, (Italy), 1973.
- (3) KELLERER (A.M.) et ROSSI (H.H.) : "The theory of dual radiation action". Rad. Res., Quartely 8, 1972.
- (4) MOTZ (J.W.), OLSEN (H.) et KOCH (H.W.) : Rev. Mod. Phys. 36, 4, 881-928 (1964), page 910.
- (5) GRYZINSKI (M.) : Phys. Rev. 138, 2A, 305-358 (1965).
- (6) VRIENS (L.) : Case Studis in atomic collision. Physics 1, Mac Daniell, Mac Dowell, North Holland Publishing 1969 (pages 337-98).
- (7) TERRISSOL (M.), PATAU (J. P.) : "Simulation du transport d'électrons d'énergie inférieure à un keV par une méthode de Monte-Carlo". 4° symposium sur la microdosimétrie, 24-28 octobre 1973, Pallanza (Italie).

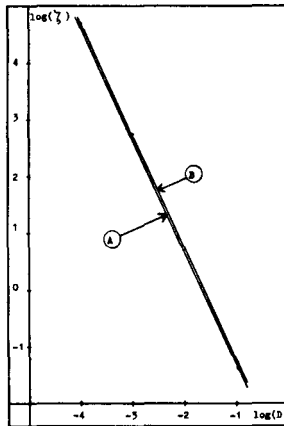

Figure 1 - Variation de $\dot{\gamma}$ en fonction du diamètre D de l'inclusion.

- A/ L'inclusion est tangente au plan d'entrée du milieu semi-infini.
- B/ Le centre de l'inclusion est situé à une profondeur égale au $2/3$ du parcours curviligne moyen des électrons de 2 MeV dans le tissu osseux.

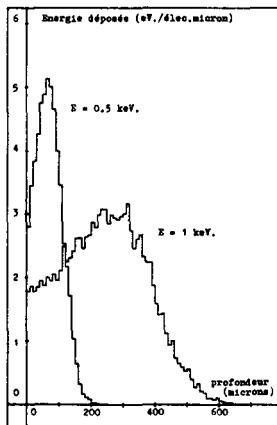

Figure 2 - Distribution spatiale de l'énergie déposée dans un milieu semi-infini d'Hydrogène.

Vertragspartner der Kommission :
Gesellschaft für Strahlen- und Umweltforschung
München

Nr. des Vertrages : 101 - 72 - 1 BIO C

Leiter der Forschungsgruppen :
Prof. Dr. W. Pohlitz

Allgemeines Thema des Vertrages :
Dosimetrie in der Mikrobiologie

The relative contributions of the direct and indirect radiation effects to the inactivation of DNA is rather unknown. Since the relevant structures in a cell are too complicated, it is necessary to investigate the inactivating effect of anorganic and organic radicals in model systems. In project II aqueous solutions of thymine were irradiated with scarcely ionizing radiation in order to investigate the indirect radiation effect on thymine molecules and its cut off by cysteine and serine.

For quantitative analysis of radiobiological investigations in microbiology and for intercomparison of these data appropriate methods were developed for the determination of absorbed dose in thin layers, the quality of X-rays and the homogeneity of radiation fields using the thermoluminescence of thin crystals of CaF_2 (project III).

Ergebnisse des Projekts Nr. II

Leiter des Projekts und wissenschaftliche

Mitarbeiter: Dr. D. Frankenberg

Titel des Projekts: The role of radicals in
the inactivation of biological target molecules

Absorption of radiation energy in target molecules in living systems is twofold, firstly by ionization and excitation (direct radiation effect) and secondly by attack of radicals, which are produced in the vicinity of the target molecules. The attack of these radicals can be modified, if in the vicinity of the target molecules such molecules are present which react with the radiation induced radicals. If it is possible to stop the radical attack on the target molecules completely by such additional scavenger molecules, then the direct radiation effect may be observed. Such experiments were performed with aqueous solutions of thymine (a DNA base) as a model system, to which were added cysteine or serine as radical scavengers. In general the destruction of the thymine chromophore was measured following the decrease of absorbance at $\lambda = 265$ nm as a function of absorbed dose. The concentration of thymine amounted 10^{-4} mol/l in all experiments whereas the concentration of the added scavenger molecules varied between 10^{-5} up to 10^{-1} mol/l. The irradiations were performed with 25 keV X-rays at a dose rate of about 2 krad/min under aerated and deaerated conditions.

One of the outstanding results of the irradiation of pure thymine solutions under aerated and deaerated conditions was the protective effect of the soluted oxygen. The oxygen enhancement ratio (OER) is smaller than one :

$$\text{OER} = 0.67 .$$

For the interpretation of this unconventional result thymine solutions were irradiated, in which all solvated electrons (e_{aq}^-) were effectively scavenged by nitrate ions. The results of these experiments together with the above mentioned ones were used to develop a reaction scheme, according to which thymine chromophores were destroyed by the radiation induced radicals. Thus, in aerated solutions the OH^\cdot -radicals only destroy thymine molecules whereas the solvated electrons are prevented from attacking thymine molecules by oxygen molecules. In deaerated solutions besides the OH^\cdot -radicals about each second solvated electron will destroy a thymine chromophore.

By addition of cysteine or serine molecules to the aqueous solution of thymine organic radicals are produced on account of the primary anorganic ones. The results show, that the produced organic radicals don't attack thymine molecules, that means cysteine as well serine have a protective effect. For example complete protection is achieved up to 60 krad for a cysteine concentration of 10^{-1} mol/l. The effectiveness in protecting target molecules depends essentially on the binding energy of reactive groups in the protection molecules as well in the target molecules. Analysing the protection experiments with cysteine and serine, one gets the result, that the effectiveness of serine in protecting thymine molecules is tenfold smaller than that of cysteine. This is due to the much higher binding energy of the H-atom in the hydroxyl group of serine in comparison with that of the H-atom in the sulfhydryl group of cysteine.

Ergebnisse des Projekts Nr. III

Leiter des Projekts und wissenschaftliche
Mitarbeiter: Prof.Dr.W. Pohlitz, Dr.D.Rebmann

Titel des Projekts: TLD in microbiological
research

For intercomparison of dosimetric data a dosimetric system has been developed, which can be distributed by mail. It includes several single thermoluminescent dosimeters for the determination of absorbed dose, absorbed dose distribution and absorbed depth dose curves. The thermoluminescent material selected for this purpose is CaF_2 due to its stable trap distribution and consequently its stable calibration factors. Therefore precise dose intercomparison between different laboratories working in microbiology can be achieved in this way. The calibration constants of CaF_2 , however, like in many other thermoluminescent systems, show an increase with increasing absorbed dose, the so-called "supralinearity". The physical reasons for this effect are not clear up to now and two hypothetic explanations are under investigation:

- (a) creation of traps by irradiation and
- (b) filling of deep traps with electrons from which they may vanish without light emission (K-traps).

Exact experiments have been performed which enable to take into account this effect precisely in dose determinations. Also the temperature dependence has been determined. From these experiments, however, a decision between both hypothesis cannot be made up to now and further experiments with different types of radiations are necessary.

GESELLSCHAFT FÜR STRAHLEN- UND UMWELTFORSCHUNG MBH, MÜNCHEN
Institut für Strahlenschutz, Neuherberg

Vertrag Nr. 101 - BIOC

Leiter der Forschungsgruppe: Dr.G.Burger und Prof.Dr.W.Jacobi

Thema: Energy transfer in model substances and radiation effects in condensed matter

The aim of this research project (No. 3.2.2.1) is the measurement and calculation of micro- and nanodosimetric functions and quantities, and the analysis of their relevancy to the characterization of the "radiation quality" for radiobiological effects. In 1972 more weight was given to the experimental and theoretical determination of microdosimetric distributions during neutron irradiation in volumes of micrometer dimensions. This year we were mainly engaged in problems of calculating the primary physical structure of fast ion tracks (e.g. recoils of neutrons) on a nanometer scale. This subject is important e.g. to improve the understanding of the particular dependencies on the particle parameters of the RBE and OER for biological effects, or for the interpretation of experimental results, which are influenced by the escape or influx of secondary electrons.

Extensive calculations (employing csda- and three-dimensional Monte-Carlo methods) of the energy dissipation patterns for monoenergetic electrons (for test purposes) and for secondary electrons ejected by fast ions in gases and solids were performed. The computational results were compared with experimental results as far as possible. The high degree of agreement found is very encouraging. To provide data for additional tests, one of us (HGP) took part in a LET_r-chamber experiment of J.W.Baum at Brookhaven National Laboratory.

Since the stage of development of our simulation programs can now be considered as rather satisfying, we intend to apply them to some selected problems of the energy deposition at the microscopic level for which other groups working under 101-BIOC contracts are going to provide experimental data. The scope of our calculations will be extended to the time dependent processes during the subsequent chemical phase.

Ergebnisse des Projekts

Leiter des Projekts und wissenschaftliche Mitarbeiter:

G.Burger, G.Leuthold, E.Maier und H.G.Paretzke

Titel des Projekts: Radiation interaction and energy dissipation at the microscopic level

Computer calculations have been performed for the determination of the primary spatial and statistical distributions of ionizations and deposited energy around the paths of heavy charged particles. The simulation methods used in our three models are indicated in fig.1 and described in more details in /1/. Much work had to be invested in the data preparation for the simulation of the secondary electron energy dissipation. Arguments for the reliability of certain cross sections measured in gases for application in calculations for the condensed phase are discussed in /2/. The formulae for the cross sections and the electron stopping power were adjusted within their estimated errors to give results consistent with experimental data for the following functions: Electron transmission and backscattering curves, range, secondary yield, depth dose and lateral dose curves, and W-values. The agreement between experimental and computational results is rather satisfying /3/.

Experimental work is in progress to provide data, which allow to put the programs to even more crucial tests: the double differential electron fluences produced a) by secondary electrons of fast ions at different radial distances in gases, and b) by scattering of monoenergetic, monodirectional electron beams on thin carbon foils. These functions were also calculated with our Monte-Carlo Codes.

The radial dose distributions around the paths of fast ions were calculated for a number of ions and energies with all three models. The good agreement (for protons see fig.2, for alpha-particles see /3/) with J.W.Baum's experimental data caused us to suggest and take part at new runs of his experiment at BNL with heavier ions (O, J, Br). Although new effects arise with these heavy projectiles/3/, after simple corrections for these effects also there the agreement between experiment and calculation is surprisingly good /4/.

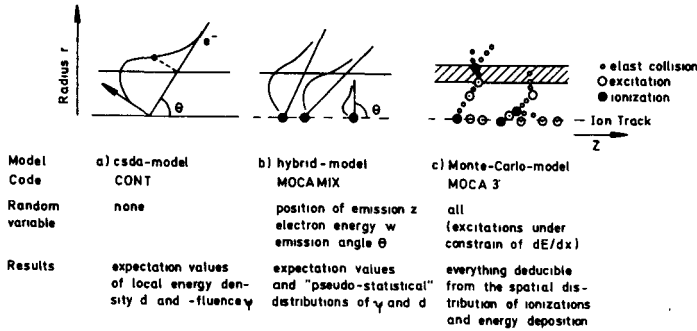

Fig.1 Principles of our three models for track structure calculations

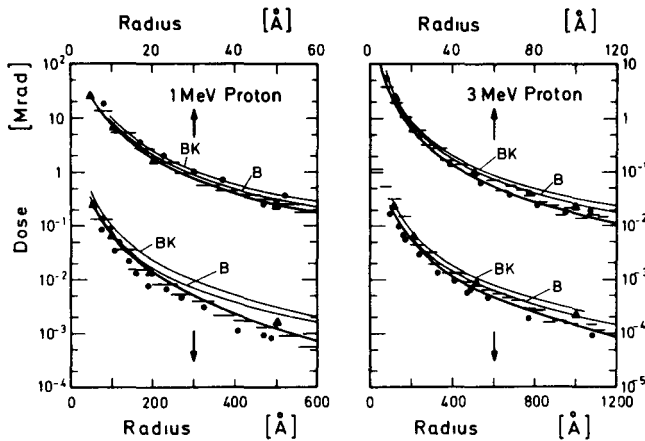

Fig.2 Radial dose distribution around protons in tissue equivalent gas (solid circles=exp.data, dark solid line=CONT, triangles=MOCAMIX, histogram=MOCA3, light lines=calculations of other authors). Further explanation in /3/.

Literature:

- /1/ H.G.Paretzke, G.Leuthold, G.Burger and W.Jacobi, "Approaches to Physical Track Structure Calculations"
 - /2/ W.E.Wilson and H.G.Paretzke, "Electron Ejection Cross Sections for Hydrocarbon Molecules and Their Implications for Phase Effects"
 - /3/ H.G.Paretzke, "Comparison of Track Structure Calculations with Experimental Results"
 - /4/ J.W.Baum, M.N.Varma, C.L.Wingate, H.G.Paretzke and A.V.Kuehner, "Nanometer Dosimetry of Heavy Ion Tracks"
- (All articles: Proc. 4th Symp. on Microdosimetry, H.G.Ebert, ed.)

- Contractant de la Commission : Université Louis Pasteur-Faculté de Médecine- Laboratoire de Biophysique des Rayonnements et de Méthodologie 11, rue Humann, 67000 Strasbourg
- N° du contrat : 101-72-1-BIOC
- Chef du groupe de recherche : R.V. RECHENMANN
- Thème général du contrat : MICRODOSIMETRY OF CHARGED PARTICLES IN DENSE MATTER

The ionographic methodology, applied to studies on energy loss of heavy charged particles in nuclear emulsions, had to be improved in order to meet the severe requirements inherent to the simultaneous recording of low and high ionizing radiations and to the particular conditions of electron microscopical observation. Preliminary attempts have also been undertaken for exploring the possibilities offered by scanning electron microscopy of tracks recorded in ionographic emulsions.

The analysis of relatively high energy secondary products distributed along α particle tracks in the 0-11 MeV energy region has been continued on an experimental and theoretical basis. Selective scanning has been carried out on ionographic sensitive layers which had been previously exposed to 11 MeV α particles and submitted to refined ionographic treatments. The histograms obtained confirm unambiguously the results described in the Annual Euratom Report Biology-Health Protection 1972 : the yield of events with radial spreads $\leq 0.5 \mu\text{m}$ and $> 0.5 \mu\text{m}$ varies in opposite sense with the energy of the primary particle. The comparison of these histograms with theoretical yields, based on revised calculations, corrected in respect to geometry, verifies our working hypothesis that most of the observed secondary events are due to energetic protons and electrons ejected by the incident ion.

A preliminary study on the behaviour of low energy electrons in nuclear emulsions has been started. A specific methodology is in development.

An approach to the determination of the mean range of 0-20 keV electrons in nuclear emulsion has been undertaken ; the results are compared with values previously obtained and with data from the literature.

PUBLICATIONS

- 1) RECHENMANN, R.V., AIGUABELLA, R. et WITTENDORP, E. Analyse de la structure fine de traces α ($E \leq 8,9$ MeV) dans des détecteurs ionographiques ayant subi un développement activé-Perspectives microdosimétriques. C.R. Acad. Sc. Paris, 13 juin 1973, t. 276, Série D, 3211-3214.
- 2) WITTENDORP, E., HORRENBERGER, A., AIGUABELLA, R. and RECHENMANN, R.V. Study of α track patterns by means of the activated development procedure for nuclear emulsions. Proc. 4th. Int. Symp. on Microdosimetry, Verbania Palanza, septembre 1973.
- 3) AIGUABELLA, R., NDOCKO NDONGUE, V.B. and RECHENMANN, R.V. Preliminary theoretical analysis of secondary products along α particle tracks recorded in ionographic emulsions. Proc. 4th. Int. Symp. on Microdosimetry, Verbania Palanza, septembre 1973.
- 4) WITTENDORP, E. Thèse de Doctorat (Mention Sciences):Nouvelles Procédures Ionographiques-Premières Applications Microdosimétriques et Autoradiographiques. Université Louis Pasteur de Strasbourg (24-11-1973).

RESULTATS du PROJET N°1

-Chef du projet et collaborateurs scientifiques : R.V. RECHENMANN, E. WIT-TENDORP, V.B. NDOCKO NDONGUE, R. AIGUABELLA*, A. HORRENBERGER.

-Titre du projet : STUDY OF THE ENERGY LOSS PATTERNS OF HEAVY CHARGED PARTICLES

It has been mentioned in former reports (1) and publications (2,3) that the application of the "activated" ionographic method to the study of the energy loss of charged particles in dense matter has lead to the observation of secondary events distributed along the track of the incident ion. In the case of α particles, which have been considered in a first phase of our program, the observed protuberances have been analysed on the basis of following hypothesis : 1) these phenomena might be a photographic effect possibly induced by the development process ; or 2) they may be short tracks of relatively high energy secondaries. All the results obtained in a preliminary experimental and theoretical "roughing up" study could better be interpreted by the short track than by the artefact hypothesis (1,2,3).

In this report, we shall describe shortly a refined methodology applied to our ionographic studies. Results obtained by means of experimental and theoretical determinations will be discussed.

A. METHODOLOGY

I. Ionography

The chosen ionographic emulsions (Ilford K5,K2,L4,Montréal B55) have been exposed at glazing angles ($4^\circ, 7^\circ, 10^\circ$) to α particles produced by a Van de Graaff** ($E \leq 11\text{MeV}$) inside an exposure box (10^{-4}Torr). After gold activation of the latent image, the development has been performed in various types of reducing solutions like amidol, mineral developers of the ferro-oxalate type as well as in so-called "compact grain" solutions. The best combination emulsion type-activation formula-developer has been systematically tested in order to determine the optimal response for each case. The improvement obtained can be seen on the photographs of figure 1.

The morphological analysis has been performed electron microscopically (OPL 100 kV) (Fig.1); the localization and the countings have been carried out at light microscopical level.

II. Scanning electron microscope observation of α tracks recorded in nuclear emulsion

In collaboration with S.HENSTRA (T.F.D.L. Wageningen-Holland), an exploration of the possibilities offered by the scanning electron microscope in ionography has been carried out. Part of the numerous methodological problems, inherent to this new observation mode, have been solved. It can be seen on figure 2 that even at the very preliminary development stage of this method some structural details can be recognized. Experiments will be undertaken in order to prospect and to increase the possibilities offered by this promising method.

* Boursier Euratom from 1-11-71 to 31-10-73

**Groupe des Laboratoires de Strasbourg-Cronenbourg.

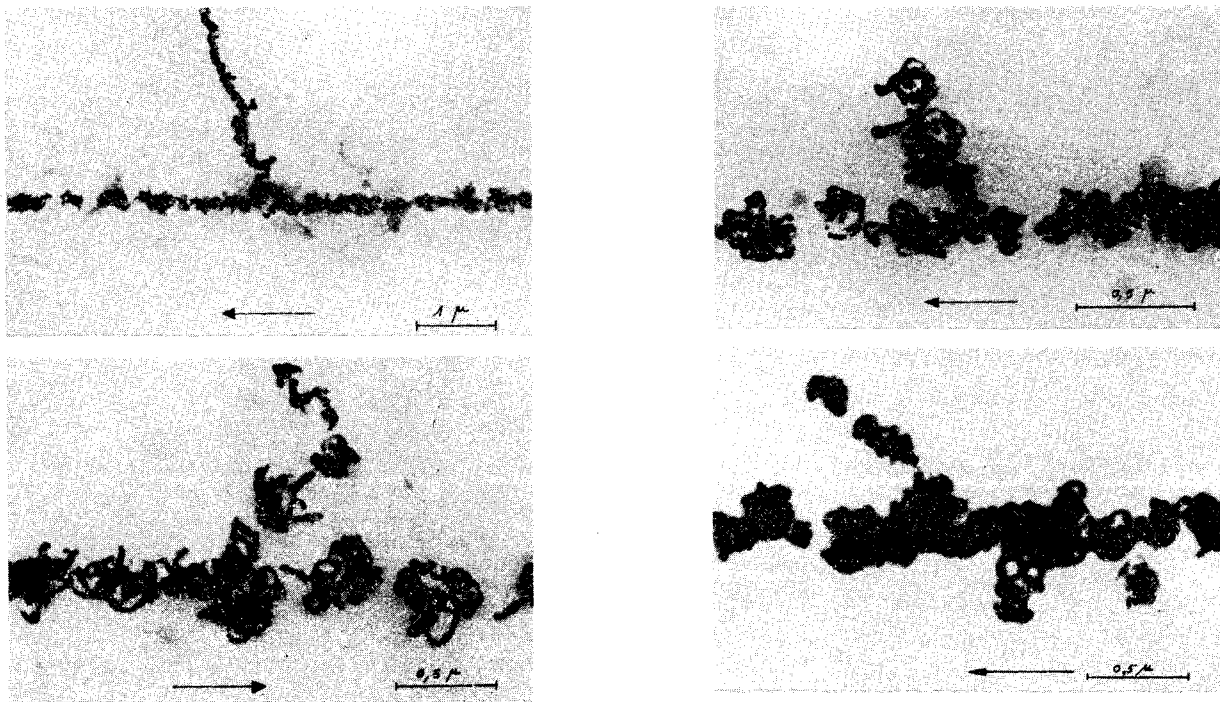

Figure 1. Electron micrographs of protuberances appearing on α tracks recorded in activated nuclear emulsion (Ilford L4), corresponding to the most frequently observed morphological aspects (Electron Microscope : OPL 100 kV).

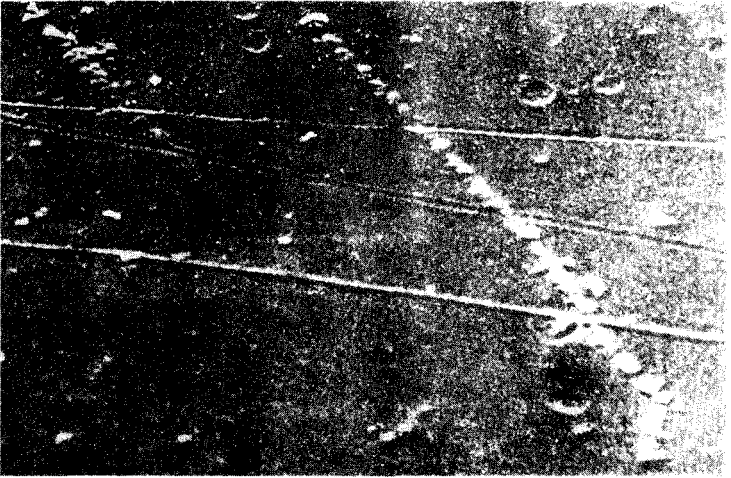

Figure 2. Scanning electron micrographs of α tracks recorded in Ilford L4 emulsion.
(Scanning Electron Microscope : JEOL JSM U3).

B. ANALYTICAL STUDY OF THE SECONDARY EVENTS

I. Experimental study

1°. Photographic artefact hypothesis

The systematic experimental study on the behaviour of the secondary events as a function of different photographic parameters (grain size, development time, sensitivity, etc...) has been continued. All the results obtained until now strongly contradict the artefact hypothesis.

2°. Secondary charged particle hypothesis

The strongest confirmation of the charged secondaries hypothesis is given by the distribution of the events along the tracks of 0-11MeV α particles ; the measurements have been carried out in the way already described (1), but in more refined experimental conditions. The results allowed us to discriminate between at least two different types of secondary products, δ rays and protons.

The protuberances have been differentiated into two classes with radial spreads $r \leq 0.5 \mu\text{m}$ or $r > 0.5 \mu\text{m}$, which can be related to the eventual secondary electrons respectively protons. It can indeed be foreseen by relatively simple considerations that most of the ejected electrons stay within or very near to the track core and are therefore counted in the first class of events, while a significant number of protons will be counted in the second class.

The corresponding histograms are given in figure 3 and 5.

Investigations on the influence of the gelatin concentration on the production of secondaries has been undertaken in the energy region below 3MeV, since the yield of detectable electrons becomes negligible in this zone. It could already be shown that the increase of the ratio CNOH/AgBr results in a higher number of events (Fig.5).

II. Preliminary theoretical analysis

1°. Determination of the production yield of secondary electrons

Considering the threshold T_0 chosen, i.e. 5 keV (1,3), two different treatments have been applied for determining the number of electrons ejected per unit path length.

For the orbitals of CNOH, and also for the outer shells of Ag and Br atoms, the binding energies remain very small with respect to the threshold T_0 chosen. Since only transfers higher than T_0 are taken into account in our determination, a "free" electrons treatment (4) has been applied in this case. As far as inner shells electrons of Br and Ag atoms are concerned, the ejection yield has been determined by means of a specific treatment for "bound" electrons (5).

By adding the computed yields of "free" and "bound" electrons, the total theoretical number N of δ rays with energies $T \geq 5 \text{ keV}$ produced by the pas-

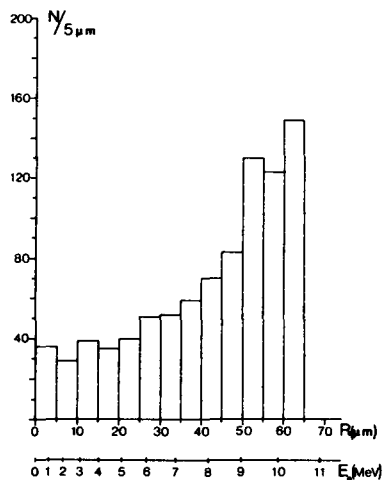

Figure : 3 Yield (per $5 \mu\text{m}$) of secondary products with radial spreads $r \leq 0,5 \mu\text{m}$ as a function of the residual range of a particles (Total count : 2000 tracks).
Emulsion : Ilford L4 - Activated development.

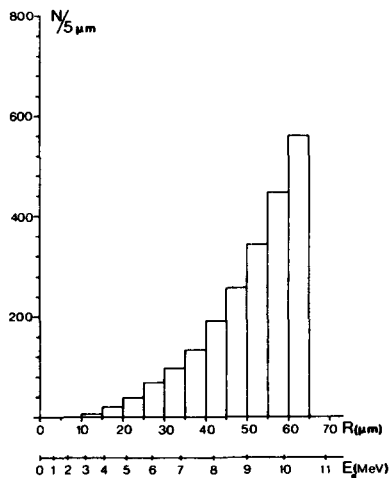

Figure : 4 Number of secondary electrons per $5 \mu\text{m}$ (theoretical) as a function of a particle residual range. Geometrical corrections have been applied to these frequencies, resulting in a strong reduction of the calculated secondaries ; indeed, most of the energetic δ rays are emitted along the axis of the incoming particle and are therefore not coming out of the track core. Notwithstanding our geometrical correction, the calculated yield remains superior to the measured one ; probably the incomplete knowledge of the range-energy relation for electrons of some keV as well as the very strong straggling of their path length may be at the origin of the discrepancy between the numerical values given by both histograms.

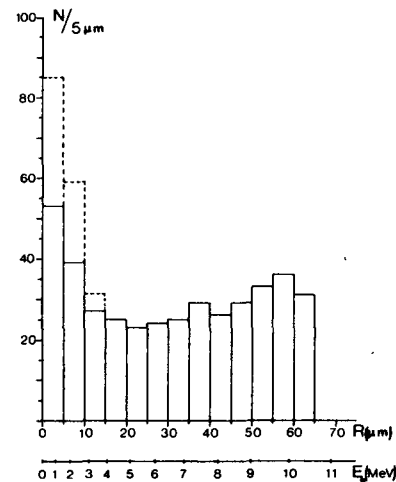

Figure . 5 Yield (per $5 \mu\text{m}$) of protuberances with a radial spread $r > 0,5 \mu\text{m}$ as a function of the residual range of a particles (Total count : 2000 tracks). Activated development.
————— continuous line : L4 emulsion
----- dotted line : "diluted" L4 emulsion, corresponding to an increase of $\sim 50\%$ of the gelatin content. The slight increase at energies $E_0 > 5 \text{ MeV}$ is probably due to a contamination by δ rays.

sage of low energy α particles ($E \leq 11\text{MeV}$) is obtained. The comparison with the experimental histogram (Fig.3) shows a good agreement in shape, but a strong numerical discrepancy, due to the fact that most of the δ rays stay inside the materialized track core. A corrective treatment has been applied, resulting in the histogram represented in figure 4.

2°) Determination of the production yield of secondary protons

The yield of the H-nuclei ejected by the incoming particle has been determined by a treatment based on the differential scattering cross section of elastic collisions given by LINDHARD et al (6).

The calculated secondary proton yields for $s = 1.6$ (s corresponding to the power law potential parameter proposed by LINDHARD) are given on figure 6 for different detection threshold energies T_0 , and on Table I where the theoretical data are compared with the experimental ones for $T_0 = 30$ keV.

This value has been obtained by extrapolation of the range energy curve for protons in a standard nuclear emulsion.

It can be seen on Table I that the theoretical yields, geometrically corrected, are in a fairly good agreement with the experimental data.

C. CONCLUSIONS AND PERSPECTIVES

At the light of the results described in this report, it appears that most of the secondary events observed along α trajectories recorded in nuclear emulsions are due to short tracks of electrons and H-nuclei ejected by the primary particle. It could also be demonstrated that relatively energetic δ rays ($T > 5$ keV) are emitted far below the 9 MeV limit.

Improvements of the accuracy and the resolution of our ionographic methods should allow a better analysis of the interaction mechanisms, not only of α particles, but also of other ions in dense media. In the frame of this work, the behaviour of protons of relatively low energies will be investigated.

REFERENCES : 1) RECHENMANN, R.V. Annual Report, EUR. 4864, 561, (1972). 2) RECHENMANN, R.V. and WITTENDORP, E. 39^{ème} Congr. Ann. ACFAS, Sherbrooke (1971). 3) RECHENMANN, R.V., AIGUABELLA, R. and WITTENDORP, E. C.R. Acad. Sc. 276, Série D, 3211 (1973). 4) FANO, U. Ann. Rev. Nucl. Sc. 1 (1973). 5) HENNEBERG, W. Z. Physik, Vol. 86, 592 (1933). MERZBACHER, E. and LEWIS, W. Hand. d. Phys. 34 166, (1958). 6) LINDHARD, J., NIELSEN, V., SCHARFF, M. and THOMSEN, Kgl. Dans. Sel. Math. Fys. Med. Band 33, N°10 (1963).

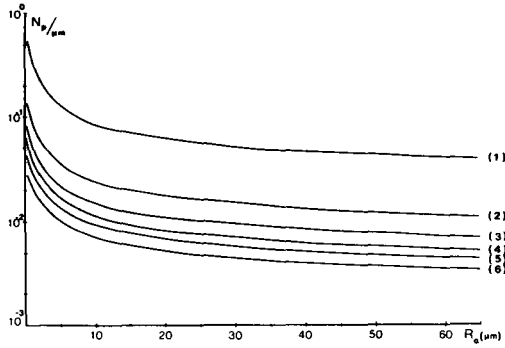

Figure 6. Yield (per μm) of ejected H-nuclei as a function of the residual range of the incident α particle, and with energies T equal or superior to a threshold T_0 . The curve (1),(2),(3),(4),(5) and (6) correspond respectively to $T_0 = 1$ keV, 3 keV, 5 keV, 10 keV, 20 keV and 30 keV.

E_α (MeV)	.285	.571	.857	1.156	1.468	2.846	3.916	4.836	5.650
Range (μm)	1	2	3	4	5	10	15	20	25
Yield (theoretical) $\times 10^{-2}$ per $1\mu\text{m}$	2.24	1.69	1.39	1.19	1.05	0.74	0.60	0.54	0.48
$\times 10^{-2}$ per $5\mu\text{m}$	7.56				4.15		3.23	2.79	2.50
Yield (theoretical) geometrically corrected $\times 10^{-2}$ per $5\mu\text{m}$ Y_{gc}	3.07				2.20		1.73	1.52	1.36
Yield (experimental) $Y_e \times 10^{-2}$ per $5\mu\text{m}$	2.65				1.95		1.35	1.25	1.15
Y_{gc}/Y_e	1.16				1.13		1.28	1.22	1.18

Table I

RESULTATS du PROJET N°2

- Chef du projet et collaborateurs scientifiques : R.V. RECHENMANN, V.B. NDOCKO NDONGUE and E.WITTENDORP.
- Titre du projet : LOW ENERGY ELECTRONS IN DENSE MATTER.

The experimental determination of the behaviour of electrons with energies ranging from about 1 to 30 keV in dense matter presents some difficulties, especially when the recording in visual detectors is considered.

In former studies, the visualization of relatively low energy electrons has been attempted (1) : electron micrographs of grain alignments could be obtained by means of a rather sophisticated methodology.

It may be expected that the development of the activated ionographic procedures will allow relative accurate measurements at light and electron-microscopical level. In this preliminary study, different techniques involved in the development of a specific methodology have been tried out. A semi-empirical determination of ranges as well as of the number of crossed AgBr microcrystals is proposed.

A. METHODOLOGY

One of the possible operation modes is to irradiate sensitive layers perpendicularly with electrons. After the usual ionographic processings, the scanning is carried out with the light or the electron microscope. In a preliminary stage, serial tests have been undertaken to find the epoxy-resin mixture allowing to embed the developed emulsion before ultramicrotomy. Electron tracks could be registered when the emulsion was poured on a tritium source. The bombardment in vacuum of the ionographic medium has until now given negative results, probably due to the fast building up of an electrostatic field on the surface of the sensitive layer. Different techniques will be tried out to overcome these difficulties.

B. COMPARATIVE EVALUATIONS OF ELECTRON PATH LENGTHS IN NUCLEAR EMULSION

In the considered energy interval (1 to 20-30 keV), different range-energy relations have been established (2,3). A semi-empirical approach giving the number of crossed microcrystals as a function of the energy has also been proposed (4); in this case, a step by step calculation was applied which corresponds in a quite realistic way to the possibilities of even ultrafine grain emulsions: indeed, at this relatively low energies, the diameter of the AgBr microcrystals is no more negligible if compared with the considered ranges (Table I and II).

We have therefore attempted an evaluation of the ranges and of the number of crossed microcrystals by means of a semi-empirical method based on an analogous calculation process.

We have assumed that the electron range is a sum of rectilinear path lengths in both the AgBr microcrystals and the gelatin. The scattering in

E(keV)	R A N G E (μm)		
	Feldman-Barkas ()	Cole ()	Proposed semi-empirical determination
1	0.02	0.0177	0.028
2	0.0695	0.0499	0.090
3	0.145	0.0943	0.197
4	0.242	0.1504	0.298
5	0.361	0.2154	0.410
6	0.504	0.2948	0.572
7	0.665	0.3805	0.700
8	0.842	0.4762	1.000
9	1.044	0.5859	1.100
10	1.262	0.7012	1.330
11	1.284	0.8244	1.520
12	1.752	0.9520	1.780
13	2.020	1.0953	2.100
14	2.300	1.2352	2.290
15	2.620	1.4087	2.670
16	2.940	1.5655	3.050
17	3.280	1.7446	3.240
18	3.640	1.9237	3.620
19	4.000	2.1140	4.005
20	4.380	2.3155	4.390

Table I

E(keV)	NUMBER OF CROSSED MICROCRYSTALS semi-empirical evaluations	
	Former approach ()	Modified approach
1	0.155	0.29
2	0.46	1.0
3	0.91	1.2
4	1.46	2.1
5	2.1	2.3
6	2.84	3.1
7	3.66	4.0
8	4.5	5.0
9	5.57	6.0
10	6.6	7.1
11	7.8	8.1
12	9.0	9.6
13	10.4	11.0
14	11.8	12.1
15	13.0	14.0
16	14.8	16.0
17	16.6	17.2
18	18.6	19.0

Table II

the microcrystals and the contraction of the emulsion during fixing have been neglected in the first stage of our determinations.

The results are given on Table I and II, representing respectively the values of the ranges and the number of microcrystals crossed, both obtained by the proposed modified semi-empirical approach. On Table I are also indicated data calculated with a formula proposed by Feldman and Barkas (5), as well as results derived from Cole (3). Table II also represents the results previously obtained (1), which differ only slightly from our actual evaluations.

A strong discrepancy can be noticed between the ranges derived from the calculations of Cole, and the values obtained by the treatments of Feldman and Barkas, which are in a good agreement with our determinations; the latter fall very near to some of our previous experimental results (1).

REFERENCES: 1) RECHENMANN, R.V., MELLONI, M. and WITTENDORP, E. Acta Histochem. Supp. VIII, 139 (1967). 2) GAUTHE, B. and BLUM, J.M. C; R. Acad. Sc. 234, 2189 (1952); LANE, R.O. and ZAFFARANO, D.J. Phys. Rev. 94, N°4, 960 (1954); FELDMAN, C. Phys. Rev. 117, N°2, 455 (1960); KANTER, H. and STERNGLASS, E.J. Phys. Rev. 126, N°2, 620 (1962); PAGES, L. et al. Atomic Data, 4, 1 (1972). 3) COLE, A. Rad. Research, 38, 7 (1969). 4) LONCHAMP, J.P. and GEGAUFF, C. J. Phys. Rad. 17, 132 (1956). 5) FELDMAN, C. and BARKAS, W.H. Nucl. Res. Emuls. Ac. Press, 446 (1963).

Vertragspartner der Kommission:
Universität des Saarlandes
Institut für Biophysik

Nr. des Vertrages: 101 - 72 - 1 BIOC

Leiter der Forschungsgruppe: Prof. Dr. H. Muth
Prof. Dr. R. Grillmaier

Allgemeines Thema des Vertrages:
Energy transfer in biological material and
model substance .

With respect to the considerations which had been described in the reports of the past years the qualitative and quantitative investigations of the radical spectra induced by X-ray-irradiation at 77 K in water solutions of DNA and tryptophane (as a radical scavenger) have been continued. The behaviour of the radicals at increasing temperature have been also explored.

In addition investigations of the radical spectra induced by alpha-ray irradiation at 77 K in water and of the temperature dependency of these radicals have been performed. Further more the investigations of radicals induced by X-rays in glycerol containing water and in culture medium have been extended to the considerable lower temperature of 4 K. Also the exploration of the radical spectra induced by tritium-beta-rays at 4 K have been started.

After irradiation at 4 K and subsequent measurement of the sample at the same temperature there are radicals detectable which are no more present in their original condition, when the irradiation and the measurement of the samples had been carried out at 77 K. Further more by comparison of the results obtained with samples, irradiated at 4 K and at 77 K informations may be expected concerning the question whether at low temperatures other

chemical reactions occur than at higher temperatures. This is important with respect to the conclusions, which can be drawn of the experimental results.

Parallel to the radical investigations the chromosome aberration rates induced by tritium beta irradiation of human lymphocytes at 77 K and their dependency on radiation dose have been studied.

Ergebnisse des Projektes Nr. 1

Leiter des Projektes und wissenschaftliche Mitarbeiter:

Prof. Dr. R. Grillmaier, Dipl.-Phys. H. Fell

Titel des Projekts: Investigations of the connection of radiation dose, radical production and radiation damage in biological systems (cells) and their components.

The concentration of the radicals as a whole induced by X-rays at 77 K in water solutions of DNA decreases only slowly with increasing temperature between 85 and 115 K. Between 115 and 135 K the decrease is fastened. In the following range from 135 to 250 K the reduction is again very slow (fig.1). The removal of the radicals between 85 and 135 K is due to the reduction of the radicals produced of water molecules (OH[•]-radicals). At temperatures higher than 150 K the samples still only contain radicals of the DNA molecules. In the range of the strongest decrease of the water radicals (105 to 135 K) the concentration of the DNA radicals increases (fig.2). One can conclude that the OH[•]-radicals undergo chemical reactions with the DNA-molecules by which the OH[•] radicals either are added to the DNA molecules or transfer their radical state to the DNA by extraction of an atom or of a molecule group of the DNA. In any case it is established that even at this low temperature indirect radiation effects may occur.

The share of the DNA radicals of the total amount of radicals at 85 K really is greater than the share of the DNA mass in the solution. By the reduction of the DNA concentration the share of the DNA radicals is not diminished by the same factor (see fig.2). Both facts prove that even below or at 85 K radiolytic product of (perhaps radiation induced free electrons) undergo chemical reactions with the DNA molecules producing additional

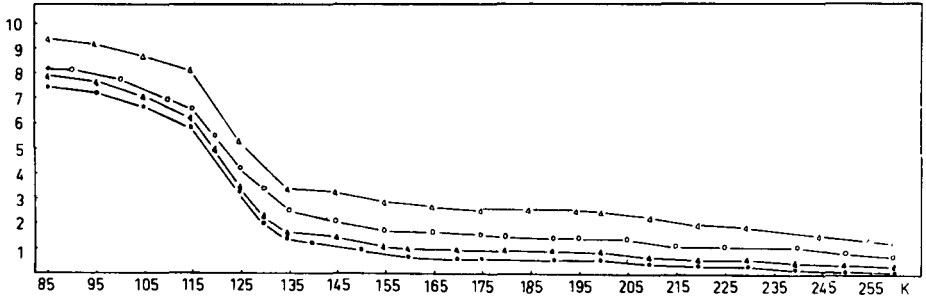

Fig. 1 Ordinate: concentration of DNA- and water radicals together (rel. units)

Abscissa: temperature (K)

Δ 1 mg DNA/ml water

○ 0,1 " "

▲ 0,01 " "

● 0,001 " "

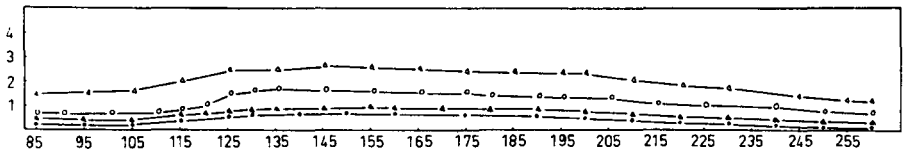

Fig. 2 Ordinate : concentration of DNA-radicals only (rel. units)

Abscissa: temperature (K)

(points and triangles as in fig.1)

DNA radicals. Therefore indirect radiation effects may be produced ^{not only} by OH^{\bullet} -radicals at higher temperatures but also at lower temperatures. Similar results have been obtained by the investigations of solutions of tryptophane in water. Tryptophane has been used because it is known as a specific radical scavenger. A quantitative comparison of these results has still to be done.

The preliminary results of the studies of radicals induced in water at 77 K by alpha rays did not demonstrate qualitative differences to those of X-ray induced radicals as far as ESR-spectra are concerned. A quantitative analysis has not yet been performed, but is intended. In all samples irradiated at 4 K with X- or tritium-beta rays and measured at this temperature, the presence of H^{\bullet} radicals has been demonstrated. (Left and right signals in the ESR-spectra of fig.3.) The central part of the spectra is similar to that obtained after irradiation and measurement at 77 K. The H^{\bullet} radical concentration decreases relatively rapidly after short annealing (for about 1 min) at the temperatures given in fig.3. At about 100 K even after these short periods of warming the H^{\bullet} radicals have disappeared almost completely. (Fig.4, curve marked by " H^{\bullet} "). At 4 K the concentration of the H^{\bullet} -radicals amounts to about 22 % of the whole radical concentration in the water sample and to about 18 % in the sample of cell culture medium. At the same dose level the concentration of the radicals producing the central parts of the ESR spectra is higher in the cell culture medium than in the water sample. The difference in radical concentrations is much more higher than the amount expected, corresponding to the mass share of the solved substances in the culture medium. It is supposed, that additional radicals are produced by reactions of free electrons not detectable in the sample, with molecules of the culture medium. The decrease of the radical concentration producing the central part of the ESR spectra is slowed down within the range of 4 to 90 K (fig.4,

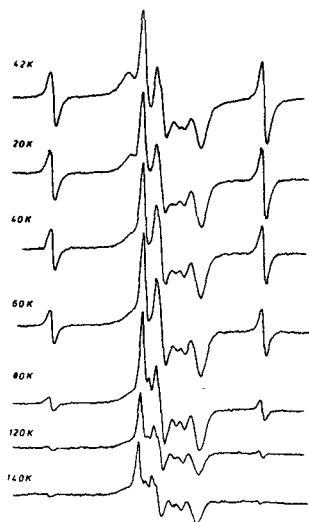

Fig. 3 ESR-spectra of water samples irradiated at 4 K.
Measurement also at 4 K after annealing the sample
at the give temperatures

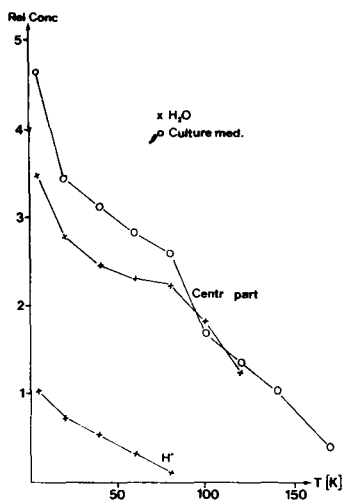

Fig. 4 Ordinate: concentration of radicals (rel. units)
H• : H• radicals
Centr. part: radicals creating the central part of
the ESR-spectra in fig.3
Abscissa: temperature (K)

curves marked with "cent. part"). It is supposed that with increasing mobility of the H[•]-radicals they undergo reactions with the water and culture medium molecules producing new radicals.

The preliminary results of the experiments with tritium-beta-rays at 4 K are similar to those described for X-rays.

According to the preliminary analysis, the chromosome aberration rates of human lymphocytes irradiated with tritium beta rays at 77 K must be higher at low doses and lower at high doses compared to the corresponding aberration rate induced by X-rays. But this must be proved by a final statistical analysis.

Publication

GRILLMAIER, R. and FELL, H.: ESR-investigations of radiation induced radicals at 4° absolute temperature.
IV. Symposium on Microdosimetry, Verbania Pallanza (Italy) 1973

Associato alla Commissione : C.N.E.N. LABORATORIO
DOSIMETRIA E STANDARDIZZAZIONE

N° del contratto : 068 - 67 - 6 BIOD

Capo del gruppo di ricerca : E. CASNATI

Tema generale del contratto : APPLICATION OF SOLID
STATE DEVICES TO THE SOLUTION OF SOME IMPORTANT
DOSIMETRIC PROBLEMS, SUCH AS DOSE INTERCOMPARISONS
BY TRANSFER INSTRUMENTS, MIXED FIELDS OF NEUTRONS
AND GAMMA RAYS, INTERFACES BETWEEN TWO DIFFERENT
MEDIA.

In order to take advantage of the research work started
in this laboratory in 1969, a special emphasis has been laid
last year upon project 1, by carrying out further experiments
on the use of ceramic discs of commercial beryllium oxide in
dose intercomparisons.

Owing to some instrumental difficulties and commercial
delays, project 2 and 3 are, on the contrary, in an earlier
stage than scheduled. Most efforts have been here concentrated
on the solution of a number of preliminary technical problems
regarding the dosimetric properties of commercial TL materials,
both in powder and in solid form.

Risultati del progetto n. 1

Capo del progetto e collaboratori scientifici :

G. SCARPA, C. GIGLIO e P. IENTILE

Titolo del progetto : USE OF SOLID STATE DOSIMETERS
AS TRANSPORTABLE INSTRUMENTS IN DOSE INTERCOMPARISONS

In order to confirm the results of the basic research work carried out for the last three years about the use of beryllium oxide in dose intercomparisons, a practical experiment has been performed during the second EULEP intercomparison. BeO discs have then been employed, in addition to LiF filled capsules, to check the actual dose given to small animals irradiated in 14 different European institutes working on radiation biology. The experiment was planned and undertaken in close cooperation with ITAL and the Dosimetry Committee of EULEP.

After a preliminary selection of the material, aiming at a higher uniformity with regard to radiation response, each disc was numbered and individually calibrated. The annealed discs were then divided into groups of six samples and each group was placed in a plastic black nylon container for use in a mouse phantom.

After exposure the discs were read out and the results corrected for the individual disc sensitivity factor. The correction factors for fading and energy dependence of BeO dosimeters were derived with appropriate experiments, whose results are illustrated in fig. 1 and 2.

Further experiments were undertaken in order to assess the influence of backscatter and sidescatter on TL response

of BeO.

A comparison between the final results obtained with the LiF and the BeO dosimeters showed a fairly good agreement between the two system if the total uncertainty of each of them is properly allowed for.

Risultati del progetto n. 2

Capo del progetto e collaboratori scientifici :
G. SCARPA, C. GIGLIO e P. IENTILE

Titolo del progetto : DOSIMETRY OF MIXED FIELDS OF
NEUTRONS AND GAMMAS BY SOLID STATE TL AND TSEE
DETECTORS

As stated in the general comments on the research programme, the progress of this project has been slowed down in 1973 by a number of technical and commercial problems.

As far as the thermoluminescence is concerned many weeks were spent to carry out a complete overhaul of the home-made reader, with the result of a marked improvement of its characteristics. A new linear heating unit was designed and assembled allowing a wide range of heating rates, from 0.2 up to 80°C for second. The new unit also allows to stop the temperature increase at any level between 30 and 500°C, for a preselected time of 10 seconds to 6 minutes.

Substantial alterations were also made on the heating tray aiming at a lower temperature gradient and an easier interchange of different trays.

The start up of experiments was furthermore postponed by long delays in the supply of ordered TL material, partly not arrived even at the end of the year.

The first large scale experiments were planned to check the general dosimetric behaviour of all available commercial TL materials. Some preliminary results are illustrated in fig. 3. In glow curves measured at low heating

rates ($0.2^{\circ}\text{C}/\text{sec}$) an additional peak can be clearly seen before the dosimetric peak: this applies to sintered TLD 100-600-700 ribbons and rods, in spite of the annealing procedure suggested by the manufacturer (1 h at 400°C and 2 h at 100°C ; 10 min at 100°C postirradiation). Some other experiments on reproducibility are now in progress.

Also in the TSEE field a considerable amount of work has been devoted to the solution of instrumental problems, in order to improve the read out equipment both as dose range and as reproducibility.

Risultati del progetto n. 3

Capo del progetto e collaboratori scientifici :

G. SCARPA, C. GIGLIO e P. IENTILE

Titolo del progetto : USE OF TSEE SOLID DETECTORS
IN DOSIMETRY AT INTERFACES BETWEEN DIFFERENT MEDIA

As pointed out in project 2, the main activity in the field of TSEE techniques has been the improvement of some features of home-made and commercial instrumentation the laboratory. The experimental stage of the project is strictly conditioned by the conclusion of this preliminary phase, now still in progress.

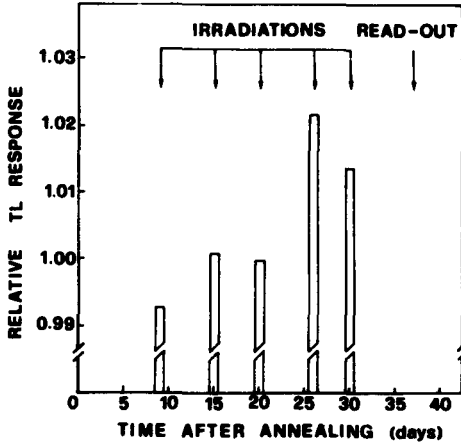

Fig. 1 - Variation of sensitivity of BeO with time when irradiations are carried out at different times, during a fixed period between annealing and read out (37 days).

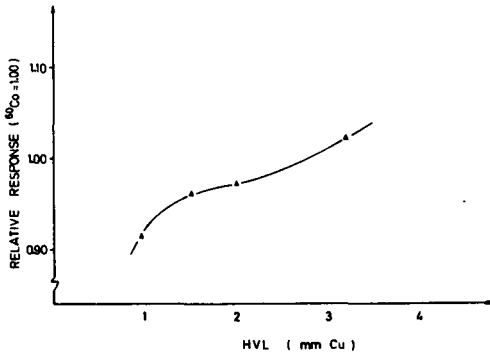

Fig. 2 - Energy response of BeO exposed in fullbackscatter conditions.

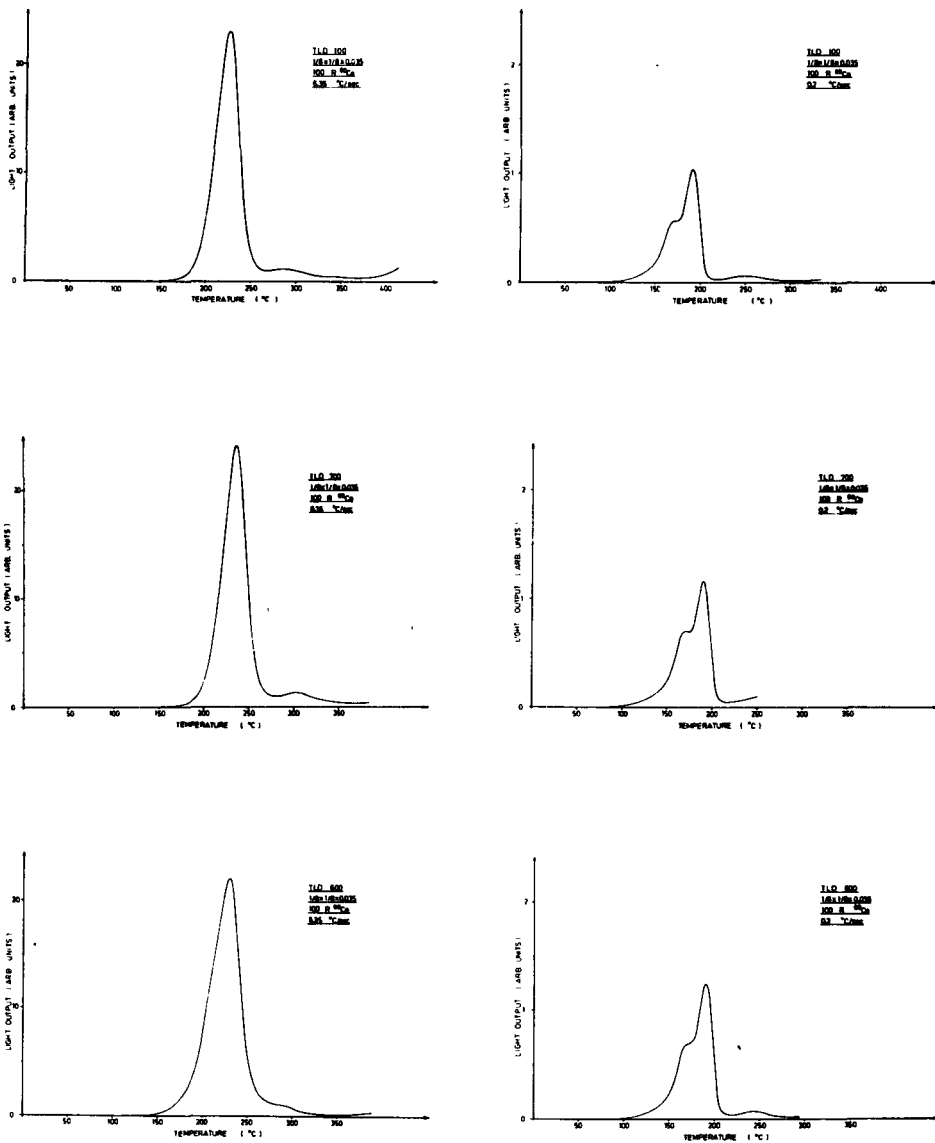

Fig. 3 - Glow curves of LiF sintered materials annealed and irradiated to 100 R ^{60}Co γ -rays and read using two different heating rates: 6.35 and 0.2 °C/sec. At the lower heating rate a three-peaks shape is evident.

Annual Report 1973

from the group contract on personnel dosimetry

Research groups from the following institutions are members of the group contract n° 065-72-1 PST C for personnel dosimetry of the Health Protection Directorate :

- Comitato Nazionale per l'Energia Nucleare (CNEEN) Roma ;
- Commissariat à l'Energie Atomique (CEA) Paris ;
- Centre de Physique Atomique, Université Paul Sabatier, Toulouse ;
- Gesellschaft für Strahlen- und Umweltforschung mbH, (GSF) München ;
- Kernforschungsanlage (KFA) Jülich.

The principal fields treated in 1973 have been :

- Research in glassdosimeters ;
- The extension of the range of monoenergetic X-radiation for calibration purposes up to 250 keV ;
- Some fundamental results in thermally stimulated exoelectron emission dosimetry has been achieved ;
- In neutron dosimetry the research on moderator-type dosimeters has advanced, α ^3He -counter has been developed and the sensitivity curves were experimentally obtained and compared with theoretical calculations ;
- The influence of the detector and its associated equipment on the sensitivity function has been measured and compared with the theory ;
- The directional sensitivity variation has been determined ;
- Research with plastic foils for track etching dosimeters for neutrons was undertaken ;
- Progress has been made in the development of methods for neutron dosimeter calibration, spectrometric methods could be improved.

The results of this research will contribute to the improvement in efficiency of the physical radiation protection control and will help to maintain the high level of safety already achieved in the nuclear field.

The research accomplished in the area of the personnel dosimetry group contract constitutes an important contribution to the promotion of research and standardization in the radiation protection field within the European Community.

The partners in the agreement were called annually to meetings. Bilateral meetings were held in order to enable the partners to exchange their research results and to coordinate their work.

The partners under the research agreement were invited to attend meetings of the technical experts on personnel dosimetry at which the implementation and findings of the intercomparison programme are discussed. Knowledge and experience gained from practical observation is thus directly reflected in the execution of research work.

A working party has been charged to set up technical recommendations for the use of thermoluminescence in personnel dosimetry and they met several times in 1973.

Contractant de la Commission :

COMMISSARIAT A L'ENERGIE ATOMIQUE

Centre d'Etudes Nucléaires de Fontenay-aux-Roses.

N° du contrat : 065-72-01-PSTC

Chef du groupe de recherche : G. SOUDAIN

Thème général du contrat : Compléter jusqu'à 250 keV la gamme des rayonnements photoniques de référence obtenus précédemment par fluorescence X.

Description générale succincte des travaux réalisés :

Réalisation de faisceaux monochromatiques X par diffraction du rayonnement sur un système cristallin déformé par courbure cylindrique.

Domaine d'énergie : 30 à 250 keV

Etude d'un système diffractant permettant d'obtenir une intensité maximale.

Résultats du projet n° 1

Chef du projet et collaborateurs scientifiques :

G. PORTAL, J.L. CHARTIER

Titre du projet : Production de rayonnements photoniques de référence pour la dosimétrie

Description des résultats :

L'ensemble des travaux effectués en 1973 a porté sur la réalisation d'un montage diffractant "composite".

Le but à atteindre, c'est-à-dire un maximum d'intensité diffractée, nous a conduits à utiliser préférentiellement des cristaux à structure "mosaïque". Un empilement de cristaux courbés plastiquement (entraînant donc un glissement des plans réticulaires successifs) constitue une bonne approche de la structure perturbée caractérisant le cristal "mosaïque". La courbure des échantillons est obtenue par chauffage et déformation sous presse à 400°C dans le cas de fluorure de lithium, à 600°C dans le cas du germanium. La difficulté majeure, surtout dans le cas du germanium, réside dans la valeur élevée de la température nécessaire pour rendre plastique ce matériau, peu compatible avec un déplacement aisé des différentes parties de la presse.

Nous n'avons pu, comme prévu, étudier le cas du cuivre, pratiquement plastique à température ordinaire, les échantillons qui nous ont été proposés étant par trop imparfaits après découpe.

Le réglage de l'ensemble dispersif s'effectue par spectrométrie du faisceau diffracté à chaque addition d'un nouveau cristal courbé. Le porte-cristal réalisé permet le réglage de l'orientation de chaque élément additionnel sans modifier celui des cristaux déjà en place. Un cliché Guinier-Tennevin donne le contrôle du réglage définitif par l'intermédiaire d'une image de la structure cristalline de l'ensemble.

La section du faisceau diffracté est voisine de 50 X 50 mm. Toutefois, suivant la nature du cristal utilisé, il y a lieu de prendre certaines précautions. Ainsi, dans le cas du germanium, de nombreux systèmes de plans réticulaires très réflecteurs voisins de ceux utilisés entraînent un recouvrement partiel des faisceaux diffractés dans la zone d'utilisation. Il est alors nécessaire de diaphragmer le cristal, donc de réduire le faisceau utile (40 X 40mm).

.../...

La spectrométrie du faisceau diffracté par un détecteur à semi-conducteur Ge (Li) a permis d'évaluer un facteur de pureté voisin de 90% pour l'ensemble des énergies de la gamme considérée.

La mesure du débit d'exposition dans le faisceau diffracté donne une valeur moyenne de 300 mR/h pour une largeur énergétique de 5 keV (de 30 à 250 keV) encadrant l'énergie choisie. Cette largeur peut être réduite, au détriment de l'intensité disponible, selon la largeur de la fente-source.

Comitato Nazionale Energia Nucleare, Bologna (Italy)

CONTRACT: 065-72-1 PSCT

G. Busuoli

STUDIES ON NEW DETECTORS USEFUL FOR PERSONAL DOSIMETRY

As in past years our contract involved two distinct projects:

1) Applicability of TSEE detectors to personal dosimetry.

Further reproducibility tests were performed using BeO discs covered with a thin conductive graphite layer. We chose this material in order to keep nearly constant the atomic number of the detector. The results obtained with this technique look good and we will try to focus our attention on a standardized method for sample preparation.

2) Applicability of solid state track detectors to accident dosimetry.

Measurements have been performed to determine exactly the applicability range of the selected track detectors (cellulose nitrate and triacetate) and their behaviour as a function of energy and incidence angle of particles in view of their use as fast neutron dosimeters based on Li^6 (n, α) or B^{10} (n, α) reactions.

Irradiations were made with Np^{237} and Pu^{239} sources in air and at different distances. Other irradiations, performed with a Co^{60} gamma source, have shown a threshold behaviour of the etching rate depending on the absorbed dose.

Project n.1: STUDY OF THE APPLICABILITY OF TSEE DETECTORS TO PERSONAL DOSIMETRY

G. Busuoli, L. Lembo

As said in past reports, the TSEE detectors studied in the Laboratorio di Fisica Sanitaria of Bologna are commercial sintered BeO discs. We must remember that they are not produced as dosimeters but for their good heat and bad electrical conductivity. This can explain the difficulties met in order to obtain a dosimeter with a good reproducibility. We are testing various techniques to solve this problem in a simple way in view of a practical use of the particular detecting material. During 1973 we practically continued the tests of the previous year which, as shown in

the last report, seemed to give good results, using a suitable geometry of the BeO discs (reproducibility measurements were improved reducing the disc diameter). As further support of the previous results, four new BeO discs of about 12 mm. diameter were irradiated with an Am²⁴¹ source, keeping the detectors in the counter in order to avoid spurious effects due to the handling.

The results obtained were very bad as shown in table 1. Mean values and standard deviations were obtained from ten different irradiations of about 1 rad for each detector.

The errors obtained were too high to be accepted in a routine application, also looking at the value of the absorbed dose used. Other similar tests on different detectors gave similar results.

A check up of the counter excluded the possibility of a wrong functioning as source of the errors.

To explain the low reproducibility of the discs, we made the assumption that the sintered BeO, being an insulator, might become charged as a consequence of electron emission from its surface, causing electric field distortions uneasily controllable. Such charges of the field can be present also in not-emitting conditions, because of the position of the insulating detectors in the counter.

For this reason the surface of the BeO detectors was made conductive by the deposition in vacuo of a thin layer of graphite.

Clean discs were annealed for 30 minutes at 600°C, then covered with graphite, annealed again in the reading device at about 350°C and in an inert atmosphere in order to avoid carbon oxidation. Seven discs were irradiated with a Co⁶⁰ gamma rays at about 25 R and the results are shown in tables 2 and 3. We had a better reproducibility but the sensitivity is low probably due to the graphite layer, which is thicker than the exoelectron range. As shown in all tables there is a different sensitivity among the discs all irradiated at the same doses and in the same geometric conditions. This can be due to two factors:

- a) the different thickness of the conductor layer, due to the different geometry used during the deposition.

b) the intrinsic differences among the discs that have not the same amount of impurities and hence of traps.

The same test was performed again on the same discs using more handling care, and the results are summarized in table 3. As shown by a comparison between table 2 and 3, the discs seem change their sensitivity with time.

Subsequent tests with other discs were performed in order to improve their sensitivity reducing the thickness of the graphite layer.

As shown in table 4 and 5 there is an increase of the sensitivity and of the reproducibility for each detector.

The results given in tables 2 to 5 are satisfactory and we hope to solve soon the problem of the reproducibility.

However, further measurements on different BeO detectors and using a standardized covering technique are needed.

During the performance of these tests we found that some preliminary irradiations and readings were needed in order to have a constant response of the detector. We are now studying such a behaviour, found also by other authors who studied TSC effects on BeO (1).

We can do also some measurements on the response as a function of energy of BeO discs, which is similar to the calculated energy dependence.

These tests however are preliminary and need detailed experimental work in next future.

(1) M.W.Harper, B.Thomas "Thermally Stimulated Current in Tissue-Equivalent Materials for Radiation Dosimetry: A Preliminary Assessment" Phys. Med. Biol. (1973) vol.18, n.3, 409-420.

TABLE 1

Am²⁴¹ irradiations. Dose of about 1 rd.

Detector	n. 1	$\bar{X} = 7997 \pm 1936$	$\sigma = \pm 24\%$
"	n. 2	$\bar{X} = 3546 \pm 1423$	$\sigma = \pm 40\%$
"	n. 3	$\bar{X} = 3229 \pm 1345$	$\sigma = \pm 41\%$
"	n. 4	$\bar{X} = 7982 \pm 1493$	$\sigma = \pm 18\%$

TABLE 2

Co⁶⁰ irradiations. Exposure of about 25 R.

Detector	n. 1	$\bar{X} = 8397 \pm 1004$	$\sigma = \pm 12\%$
"	n. 2	$\bar{X} = 8141 \pm 863$	$\sigma = \pm 11\%$
"	n. 3	$\bar{X} = 6293 \pm 852$	$\sigma = \pm 13\%$
"	n. 4	$\bar{X} = 7901 \pm 978$	$\sigma = \pm 12\%$
"	n. 5	$\bar{X} = 12436 \pm 1069$	$\sigma = \pm 8\%$
"	n. 6	$\bar{X} = 15514 \pm 387$	$\sigma = \pm 2\%$
"	n. 7	$\bar{X} = 12169 \pm 422$	$\sigma = \pm 3\%$

TABLE 3

Co⁶⁰ irradiations. Exposure of about 25 R.

Detector	n. 1	$\bar{X} = 8264 \pm 268$	$\sigma = \pm 3\%$
"	n. 2	$\bar{X} = 9816 \pm 876$	$\sigma = \pm 8\%$
"	n. 3	$\bar{X} = 7321 \pm 393$	$\sigma = \pm 5\%$
"	n. 4	$\bar{X} = 8224 \pm 756$	$\sigma = \pm 9\%$
"	n. 5	$\bar{X} = 13572 \pm 1618$	$\sigma = \pm 11\%$
"	n. 6	$\bar{X} = 21266 \pm 1200$	$\sigma = \pm 5\%$
"	n. 7	$\bar{X} = 12795 \pm 762$	$\sigma = \pm 5\%$

TABLE 4

Co⁶⁰ irradiations. Exposure of about 13 R.

Detector	n. 1	$\bar{X} = 6775 \pm 616$	$\sigma = \pm 9\%$
"	n. 2	$\bar{X} = 5850 \pm 243$	$\sigma = \pm 4\%$
"	n. 3	$\bar{X} = 7437 \pm 674$	$\sigma = \pm 9\%$
"	n. 4	$\bar{X} = 7483 \pm 290$	$\sigma = \pm 3\%$
"	n. 5	$\bar{X} = 7776 \pm 1027$	$\sigma = \pm 13\%$
"	n. 6	$\bar{X} = 9152 \pm 704$	$\sigma = \pm 7\%$

TABLE 5

Co⁶⁰ irradiations. Exposure of about 7 R.

Detector	n. 1	$\bar{X} = 12178 \pm 506$	$\sigma = \pm 4\%$
"	n. 2	$\bar{X} = 11353 \pm 325$	$\sigma = \pm 2\%$
"	n. 3	$\bar{X} = 8257 \pm 189$	$\sigma = \pm 2\%$
"	n. 4	$\bar{X} = 13741 \pm 305$	$\sigma = \pm 2\%$

Project n. 2: APPLICABILITY OF SOLID STATE TRACK DETECTORS TO ACCIDENT
DOSIMETRY

A. Fassò, A.Cavallini

The part of the work that deals with thermal neutron dosimetry has been finished. For this purpose we used a thin LiF converter placed on cellulose nitrate or triacetate, calibrated against a known thermal source.

For fast neutron dosimetry we followed the Mourgues's studies (1), using (n, α) reaction in Li^6 or B^{10} .

In the fast neutron range, the selected reaction shows a strong energy dependence related to:

- a) cross section
- b) angular distribution of emitted particles
- c) energy distribution of emitted particles.

We can easily correct our data for cross section dependence but, due to the high dependence of plastic detector response on incidence angle and energy of particles emitted, we cannot do it for spectral distribution. In both cases the response has a threshold behaviour, more or less evident according to optical conditions of scanning.

We were so compelled to further investigate these "detection limite", as defined by Paretske (2), testing particularly there response to low energy particles (below 2 MeV). We have found few data about this energy range.

Three different and independent approaches to the threshold problem were followed:

- 1) we irradiated our dosimeters (CA-8015- KODAK cellulose nitrate and TN- BAYER cellulose triacetate) with a Np^{237} source and we recorded the track as a function of etching time (fig.1).

These measurements, together with the measurements of the thickness of material erased as a function of time, allow us to calculate thickness necessary to slow down all particles emitted by the source below the threshold energy. However it is necessary to take into account the variation of the energetic and angular distribution and of the number of particles reaching deeper points in the specimen.

(This is also necessary for the particles emitted by the LiF converter in the (n, α) reaction).

- 2) We irradiated the detectors with a Pu^{239} source at different distances in air. The measurements are in course. We are also performing again all tests changing the incidence angle. Also these measurements will need calculations of the thickness removed and of the corresponding energy loss.
- 3) Finally we exposed the detectors to Co^{60} gamma rays (exposure values from 1 to 10 Mrd) and we measured the thickness removed per unit time as a function of dose. In opposition to other authors' results we think that, at least for cellulose triacetate, a threshold effect exists; i.e. etching rate is approximately constant up to a given value of dose, above which it increases with dose. Obviously this "detection limit" depends on different simultaneous effects related to the optical system and the diffusion of the reagent along the track. Results are shown in fig. 2 and 3.

Etching rate for cellulose nitrate is constant for a given dose (the curves are straight-lines); for cellulose triacetate, instead, the etching rate seems to increase with time. That is probably due to the aging of the plastic surface, as reported by some authors.

We referred to a mean etching rate, but probably we shall have better results using the initial one because it is in the first layer that tracks appear. In fig. 4 and 5 are shown the average slopes of the curves, drawn in the former figures, as a function of the absorbed dose.

To interpret correctly these data for our purposes, it will be necessary to calculate the microscopic energy deposition along the track. For this we will use the calculations of Paretske and Monnin (3) (4) and our own simple calculations on restricted LET.

It is well known that the geometric characteristics (and consequently the detection possibilities) of a track depend on g and v , respectively in the fresh material and along the track.

Using as a detector a specimen preirradiated to a gamma dose just below the threshold, we expect to leave g unchanged and to increase v (also when the threshold is not very well defined, we can obtain a variation of g less than that of v , modifying the ratio v/g). The track form would appear lengthened, and the detection limit is lower.

This possibility increases the applicability of plastic detector to heavy charged particles spectrometry.

From the above measurements, we calculated the activation energy Q which appears in kinetic chemistry formulae. Fig. 6 shows the behaviour of Q as a function of dose in irradiated material. Experiments are planned for cellulose nitrate.

Finally we wish to say that, as shown in fig. 4 and 5, we can use the plastic detectors as gamma-dosimeters for doses greater than 3 Mrd; this seems us a very important possibility even if other detectors have the same performance in this dose range.

REFERENCES

- (1) M.Mourgues - Mémoire présenté au Conservatoire National des Arts et Métiers pour l'obtention du diplôme d'ingénieur D.P.R. (Sept. 1970).
- (2) H.G.Paretzke - GFS - Bericht S 138 (Mai 1971).
- (3) H.G.Paretzke - Private communication.
- (4) M.Monnin - PNCF 68-Ri 9 (Juin 1968).
- (5) G.S.Hurst, R.H.Ritchie - ORNL - 2748 (Pt.A).

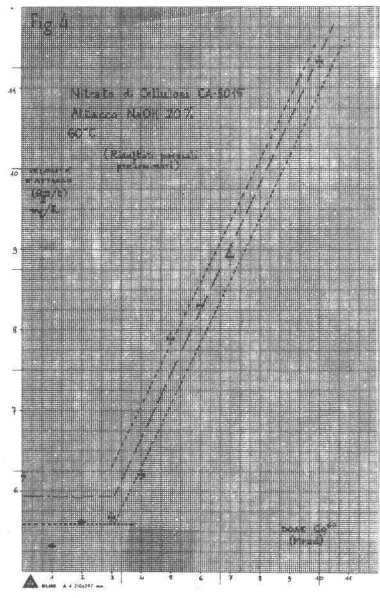
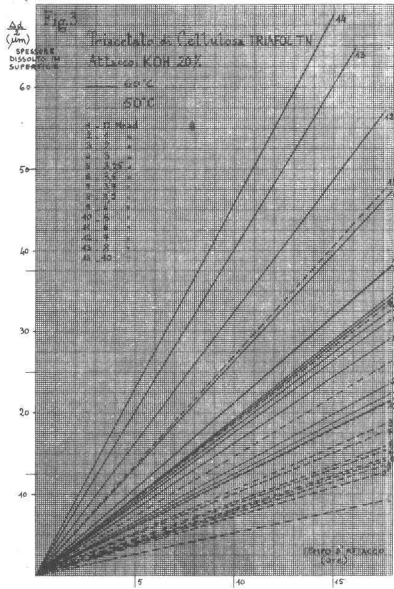

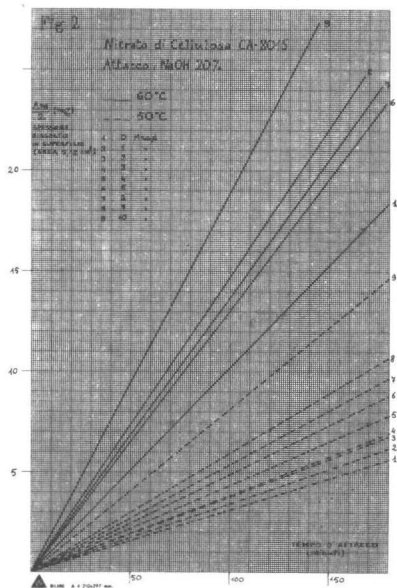
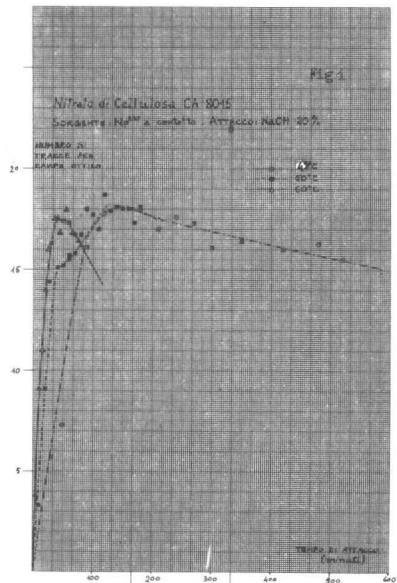

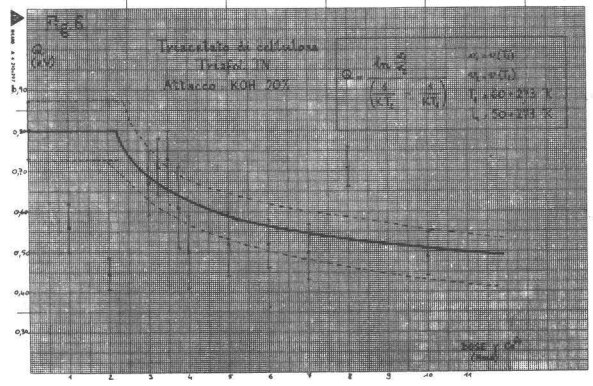
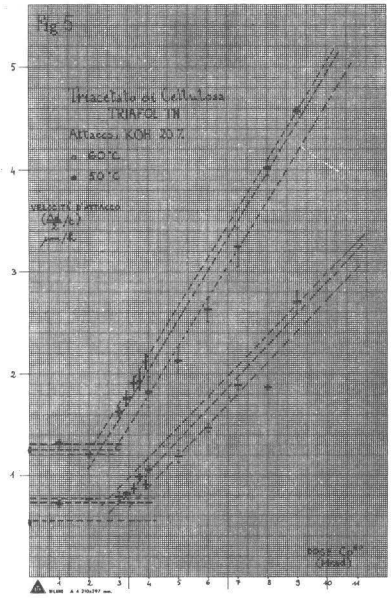

Contractant de la Commission : Centre de Physique Atomique,
118, route de Narbonne
31077 TOULOUSE CEDEX

N° du contrat : 069 73 1 PST F

Chef du groupe de recherche : D. BLANC

Thème général du contrat : Dosimetry by measure of optical and electrical effects in phosphate glasses.

Determination of changes in the electrical conductivities of metaphosphate glasses under the condition of external applied electric field (till $1,8 \cdot 10^5$ V/cm) and irradiated with gamma-rays from a Co^{60} source (2,6 Curie) - Exposure rate varied between 10 R/h and 10 000 R/h.

Résultats du projet n° 1

Chef du projet et collaborateurs scientifiques : J. BARTHE, L. COMMANAY, J. CASANOVAS.

Titre du projet : Dosimétrie par conduction dans les verres aux phosphates.

DESCRIPTION DES RESULTATS.

Nous avons utilisé des disques en verre aux phosphates BC_1 (C.E.C.) de teneur en argent variable (0 à 12 % en poids), de diamètre $\phi = 23$ mm, d'épaisseur $e = 2\,000\ \mu\text{m}$ et $500\ \mu\text{m}$. Composition : $\text{NaPO}_3 - \text{Ba}(\text{PO}_3)_2$. Les verres sont obtenus par fonte et polissage.

La cellule de mesure comporte le disque de verre maintenu entre deux plaques de téflon où sont fixées les connections électriques. Les électrodes en or, argent ou aluminium sont réalisées par métallisation sous vide (10^{-5} torr), les contacts pris à la laque d'argent.

I - Conductivité naturelle en fonction de la température.

Nous avons étudié $\log \rho$ (ρ : résistivité entre 10^9 et $10^{14}\ \Omega \cdot \text{cm}$) en fonction de $1/T$ (T : 243°K à 353°K).

La pente B et le coefficient A sont calculés à partir de l'équation de RASCH et HINRICHSEN $\log \rho = A + \frac{B}{T}$, B est assimilé à une énergie d'activation ϕ (eV) = $2 \cdot 10^{-4} B$ (°K).

Verre $e = 2000\ \mu\text{m}$	à 0% (Ag)	à 2% (Ag)	à 8% (Ag)
A	- 1,947	- 2,962	- 3,047
B (°K)	3 887	4 195	4 351
ϕ (eV)	0,777	0,839	0,870

La résistivité est plus grande pour les verres d'épaisseur $e = 500 \mu\text{m}$ (rapport 2 à 3) mais l'énergie d'activation garde sensiblement la même valeur.

Verre $e = 500 \mu\text{m}$	à 4 % (Ag)	à 8 % (Ag)
A	- 2,55	-2,957
B (°K)	4 401	4 542
ϕ (eV)	0,880	0,908

Ces valeurs de l'énergie d'activation (entre 0,770 eV et 0,900 eV) montrent que la conduction naturelle est essentiellement de nature ionique (37 % de mûles Na_2O). Ces résultats sont en accord avec les données g n rales sur la structure du verre.

II - Conductivit  induite par rayonnement gamma.

Nous avons utilis  la m me cellule exp rimentale. Le d bit d'exposition a  t  calcul    l'emplacement de la cellule.

Nous avons  tudi  le courant de conduction induit par rayonnement gamma, calcul  par diff rence des courants relev s avec et sans source, pour diff rents d bits d'exposition (figure 1, 2, 3, 4).

Pour $E < 10^4 \text{ V/cm}$, la loi de variation du courant de conduction induit en fonction du d bit d'exposition est de la forme $I_i = K D^n$ avec $n \approx 0,63$, pour $E > 10^4 \text{ V/cm}$ il appara t un r gime d'avalanche (conduction  lectronique). Nous avons observ  une variation de la r sistivit  apr s irradiation, augmentation de ρ (verre sans Ag), diminution de ρ (verre avec Ag).

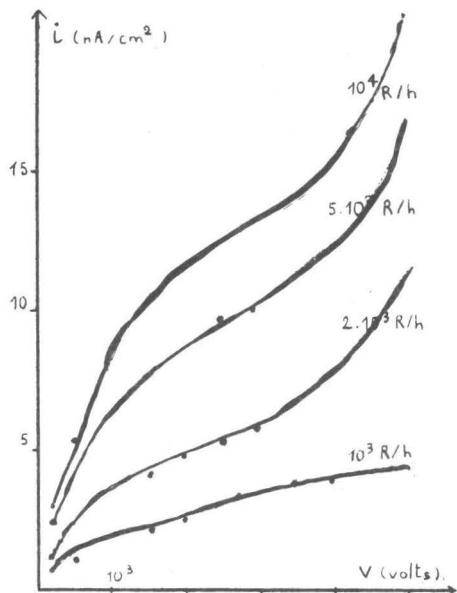

Figure 1 - Courant induit en fonction de la tension, 8 % Ag, $e = 2000 \mu\text{m}$.

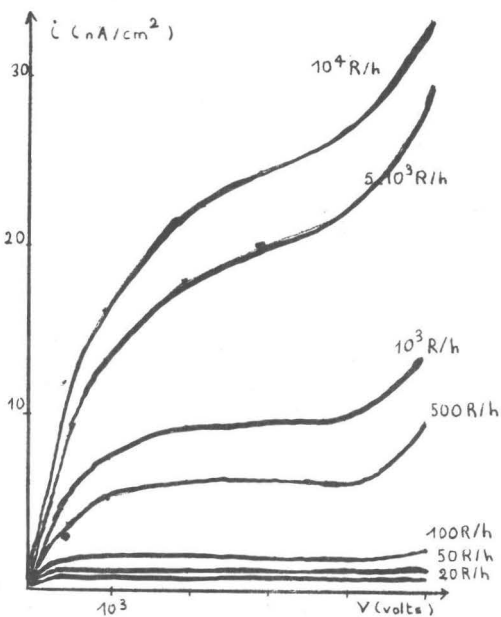

Figure 2 - Courant induit en fonction de la tension, 8 % Ag, $e = 500 \mu\text{m}$.

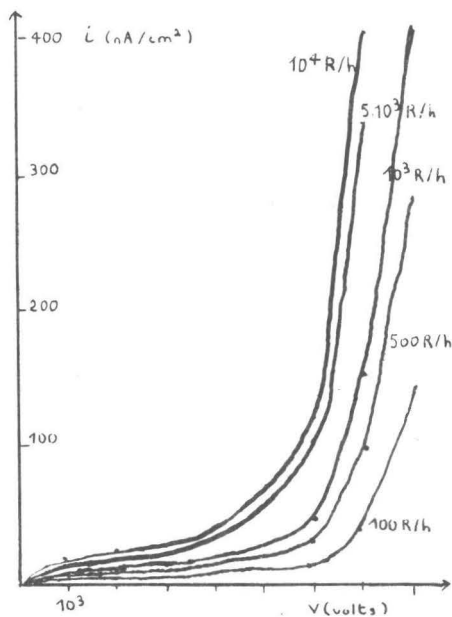

Figure 3 - Courant induit en fonction de la tension, 0 % Ag, $e = 500 \mu\text{m}$.

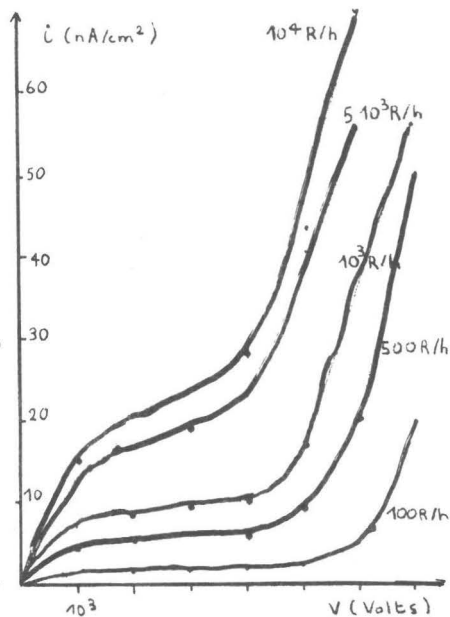

Figure 4 - Courant induit en fonction de la tension, 12 % Ag, $e = 500 \mu\text{m}$.

Contrat EUR N° 65-72 - 1 PSTC

CEA N° BT-II / 13.217 - D.4

Chef du Groupe de Recherche : M. Michel BRICKA

Description générale succincte des travaux accomplis :

Le développement du compteur à Hélium 3 destiné à équiper les sphères modératrices a été poursuivi, le prototype à fenêtre céramique étudié en 1972 a été abandonné au profit d'un modèle à parois métalliques, le volume utile restant placé en bout du compteur. L'isotropie et le rendement sont très satisfaisants.

Il s'est avéré nécessaire de développer un préamplificateur adapté à ce compteur. Le schéma électronique retenu permet d'obtenir des tensions de fonctionnement nettement plus basses et des paliers de comptages longs et de faible pente.

Une campagne de mesure auprès du Van de Graff de 5 MeV du CEN/Cadarache a été effectuée pour les sphères de Bonner équipées de compteurs à Hélium. La bande d'énergies étudiée allait de 500 KeV à 7 MeV. L'accord avec les résultats obtenus précédemment par Mme M. Dolias et avec les courbes de réponse calculées par R. Caizergues est satisfaisant. Il apparaît cependant que la précision des calculs est insuffisante pour les énergies supérieures au MeV, qui devront donc être étudiées en détail de façon expérimentale.

Les essais de spectrométrie ont été poursuivis auprès de diverses sources, le compteur à Hélium étant mis en oeuvre pour la première fois en spectrométrie pour l'étude du spectre de fuite du réacteur RB de Vinca (Yougoslavie).

Les mesures auprès du bloc sigma mettent en évidence la nécessité de préciser les courbes de réponse dans la région des énergies basses.

Development of the Helium 3 counter for moderating spheres has been continued. The prototype with a ceramic window studied in 1972 is forsaken for a model with metallic walls, the useful volume remaining at the extremity of the counter. Isotropy and efficiency are very satisfying.

It proved useful to develop a preamplifier adjusted to this counter. The chosen electronic diagram allows to obtain operating voltages notably lower and very good counting plateau.

A measurement campaign near the 5 MeV Cadarache Van de Graaff has been performed for Bonner spheres provided with helium counters. The studied energies band was 500 keV - 7 MeV. The agreement with the results previously obtained by Mrs M. Dolias and with response curves calculated by R. Caizergues is quite good. However it appears that the precision of calculations is not sufficient for energies higher than 1 MeV which must be experimentally studied.

Spectrometry tests have been continued near various sources, the helium counter being used the first time for spectrometry with a view to studies about RB Vinca Reactor leakage spectra.

Measurements near sigma pile make obvious the need to precise response curves in the low energies region.

Titre : Développement d'un compteur à Hélium 3

Noms des chercheurs : M. MOURGUES. R. PRIGENT.

Description des résultats :

Le compteur à fenêtre céramique développé en 1972 présentait des caractéristiques intéressantes du point de vue tension de fonctionnement et isotropie, mais la présence de la céramique occasionnait une dérive relativement importante -15 à 20% - lors de la mise en route. La fenêtre céramique a donc été supprimée pour aboutir à un modèle à parois entièrement métalliques à volume sensible en bout.

Les dimensions restent identiques :

Diamètre : 8,8 mm Longueur : 10 mm

ainsi que le remplissage :

Hélium 3 : 8 bars Krypton : 2 bars Autocoupeur : Σ

Par ailleurs, un préamplificateur adapté a été développé à partir d'un schéma utilisé par le Bureau International des poids et mesures.

On utilise, en entrée, un préamplificateur de charge suivi d'étages d'amplification. Le gain de 120 permet d'obtenir des signaux facilement transmissibles à distance importante.

Le schéma de l'électronique est donné sur la figure 1.

La mise en oeuvre de cette électronique a permis d'abaisser considérablement la tension de fonctionnement puisqu'il est possible d'obtenir des paliers de 3 à 400 volts avec une tension moyenne de 800 volts et une pente de l'ordre de 3% (fig. 2).

La sensibilité du compteur dans ces conditions est :

$$0,36 \text{ imp/n.cm}^{-2} \cdot \text{sec}^{-1}$$

L'isotropie déterminée avec un flux thermique directionnel est excellente (fig. 3).

HELIUM 3 COUNTER DEVELOPMENT

The counter with ceramic window studied in 1972 had interesting characteristics for operating voltage and isotropy, but the presence of ceramic gave rise to a rather important drift - 15 to 20 % - at the time of voltage setting. So the ceramic window was discarded leading to an new model with metallic walls and end sensitive volume.

The dimensions remain the same:

diameter : 8,8 mm length : 10 mm

and also the filling :

Helium 3 : 8 bars Krypton : 2 bars

Autocutter : Σ

Incidentally, a convenient preamplifier was developed from a diagram in use at the Bureau International des Poids et Mesures.

A charge preamplifier is used for entrance, followed by amplifying stages. A gain of 120 allows to obtain signals easy to convey at long distances.

The electronic diagram is given on Fig. 1

Such an electronic allow to lower notably the operating voltage, since it is possible to have plateaux of 300 to 400 volts with a mean voltage at 800 volts and a 3 % slope (Fig. 2).

Counter sensitivity in such conditions is :

$$0,36 \text{ imp/n.cm}^{-2}\text{sec}^{-1}$$

Isotropy, as determined with a directionnal thermal flux, is very good (Fig. 3).

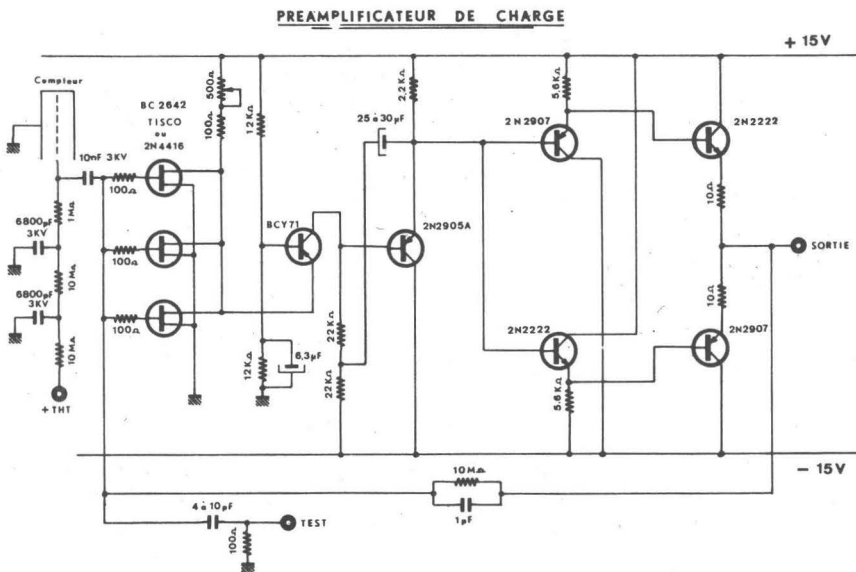
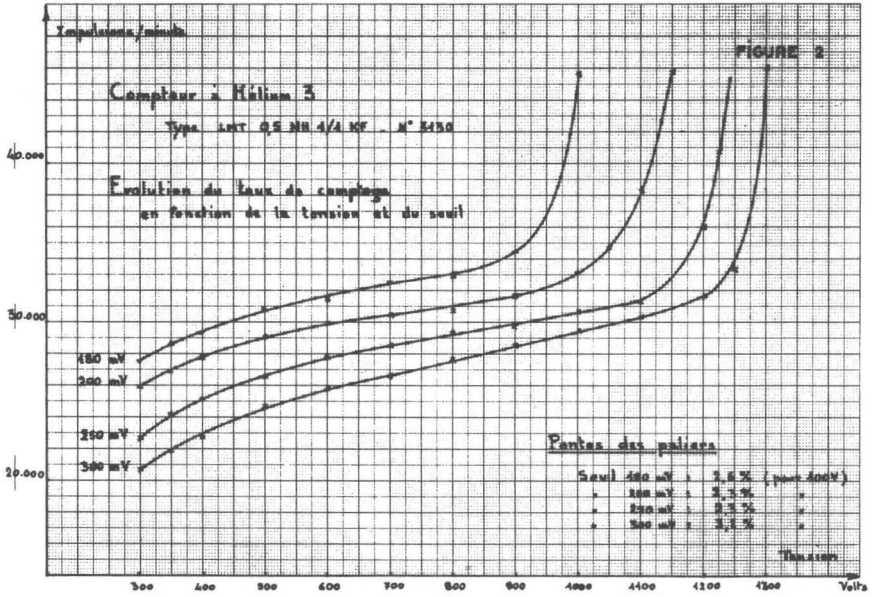
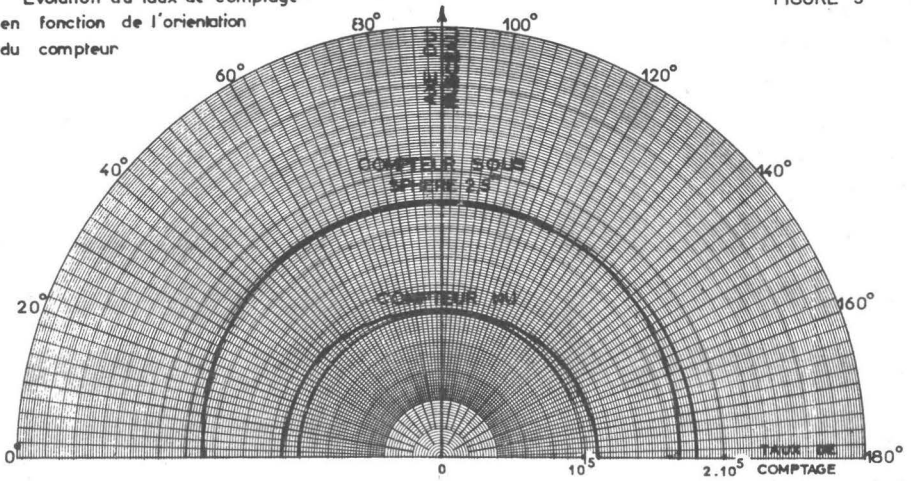

FIGURE 1



Evolution du taux de comptage
en fonction de l'orientation
du compteur



Titre : Détermination des courbes de réponse (compteur ^3He)

Noms des chercheurs : J. CERCY

Description des résultats :

Une nouvelle série de mesure a été effectuée auprès du Van de Graaff de 5 MeV du CEN Cadarache.

Elle concernait les énergies comprises entre 500 KeV et 7 MeV.

Le compteur utilisé était rempli à une pression inférieure à la pression nominale et le préamplificateur PBF 1 qui lui était associé imparfaitement adapté à ce type de compteur. Les résultats obtenus restent cependant valables en valeur relative. Ils peuvent être comparés avec les données expérimentales de Mme M. DOLIAS (1) et aux courbes calculées par R. CAIZERGUES (2).

Les figures 4 et 5 présentent la synthèse de ces différentes détermination pour les énergies comprises entre 100 KeV et 10 MeV.

On constate que les diamètres de sphère supérieurs à 5" pouces, les résultats expérimentaux au dessus de 1 MeV ne correspondent plus correctement aux valeurs calculées. Ceci doit être attribué au fait que le découpage en 16 groupes larges d'énergie utilisé par R. CAIZERGUES, dans ses calculs ne permet pas une définition précise des courbes de réponse dans les régions de forte variation.

Il est donc nécessaire d'effectuer pour les énergies supérieures à 1 MeV, une détermination expérimentale en neutrons monoénergétique avec un découpage en énergie assez serré.

(1) M. DOLIAS

Euratom - Rapport annuel 1971 - Programme Biologie - Protection Sanitaire - P. 196 - 197

(2) R. CAIZERGUES - G. PULLOT

Rapport CEA R. 4400 - 1972

Calcul de la réponse des sphères de Bonner pour les détecteurs ILi, He et Mn.

RESPONSE CURVES DETERMINATION (^3He COUNTER)

A new set of measurements was performed near the 5 MeV Cadarache Van de Graaff, regarding energies between 500 keV 7 MeV.

The counter used was filled at a pressure lower than nominal pressure and the associated PBF1 preamplifier was not perfectly adjusted for this type of counters. The results obtained remain yet valid as relative values. They can be compared with Mrs Dolias (1) experimental data and with response curves calculated by R. Caisergues (2)

Fig. 4 and 5 give a synthesis of these various determinations for energies between 100 keV and 10 MeV.

One can see that, for sphere diameters greater than 5 inches, experimental results over 1 MeV do not agree accurately with calculated values. Probably, because the 16 large energies groups used by R. Caisergues for calculation, does not allow a precise definition of response curves of regions where variation is large.

So it is necessary, for energies greater than 1 MeV, to make an experimental determination of the response curves, with a tight energy cutting.

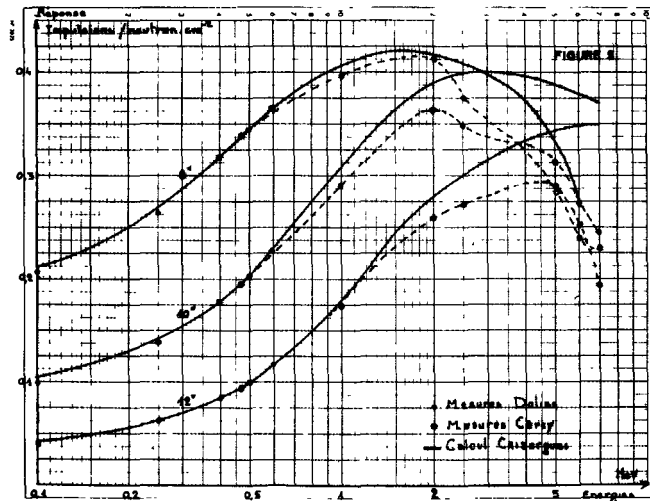
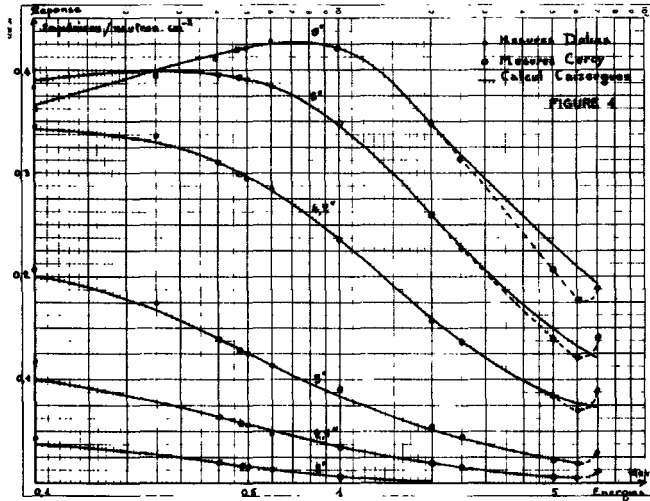

Titre : Spectrométrie des neutrons par la technique multisphère

Noms des chercheurs : M. BRICKA - M. MOURGUES

Description des résultats :

Des déterminations de spectres de neutrons ont été effectuées avec des sphères équipées de cristaux d'iodure de lithium pour diverses sources de la station Stirca.

Les figures 6 et 7 présentent, les spectres obtenus pour l'empilement graphite Sigma à 30 et 50 cm de la face avant du bloc, pour le convertisseur nu et avec écran de 6 cm de polyéthylène ou 30 cm de graphite.

Sur le tableau I figurent les taux de comptages mesurés pour les différents diamètres de sphères ainsi que l'écart avec les valeurs correspondantes calculées à partir des spectres.

Les différents spectres pour le convertisseur peuvent être comparés à ceux qui avaient été établis précédemment par G. BENEZECH (1) utilisant un compteur proportionnel à protons de recul.

Pour l'empilement graphite on constate que les écarts entre valeurs calculées et valeurs mesurées sont relativement importantes. Ceci souligne la nécessité d'améliorer la précision des courbes de réponse pour les énergies inférieures à 10 keV.

La répercussion des erreurs sur les valeurs intégrales telles que la fluence par bandes larges d'énergie reste faible ainsi qu'en témoigne la comparaison avec les données de J. CERF (2) qui a effectué en 1970 l'étalonnage de ce bloc avec des détecteurs à activation.

	Débit de fluence 0,3 m		Débit de fluence à 0,5 m	
	Thermique n. cm ⁻² . s ⁻¹	Epithermique n. cm ⁻² . s ⁻¹ par unité de lé- targie	Thermique n. cm ⁻² . s ⁻¹	Epithermique n. cm ⁻² . s ⁻¹ par unité de lé- targie
Détecteur Or	2,3.10 ³	33,2	1,58.10 ³	18,6
Sphères	2,43.10 ³	27,8	1,64.10 ³	18,9

f.4

- (1) G. BENEZECH, M. BROSSON, R. VENTRE
EURATOM - Rapport annuel 1971 - Programme Biologie - Protection
Sanitaire P. 192.193
- (2) J. CERF, R. VENTRE
Rapport interne SESR 70/14
Etalonnage en flux thermique de l'empilement graphite Sigma.

Le compteur à ^3He sous sphères modératrices a été mis en oeuvre pour la détermination de spectre de fuite auprès du réacteur RB de Vinca (Yougoslavie). Malgré une électronique imparfaitement adaptée (Préamplificateur PBF1) les résultats obtenus peuvent être considérés comme encourageants.

Les mesures faites avec les sphères de Bonner ont été combinées aux données fournies par ailleurs par le spectromètre neutron à activation SNAC. Les spectres sont obtenus par la méthode des spectres modèle en version "moindres carrés".

Le tableau II présente les résultats de mesure et les valeurs recalculées à partir des spectres obtenues, qui sont donnés sur la figure 8.

On notera que pour les mesures à 4 m, la sphère de 2" a été éliminée dans l'exploitation des données en l'affectant d'un facteur de précision élevé car elle conduisait à des résultats aberrants.

Comme on l'avait déjà constaté (3) il y a divergence entre le soufre et la sphère de 12", l'intercalibration des 2 systèmes de détecteurs -sphères et SNAC - n'ayant pas encore été effectuée.

(3) M. BRICKA - J. CERCY

EURATOM - Rapport annuel 1972 - Programme Biologie - Protection sanitaire.

NEUTRON SPECTROMETRY BY MULTISPHERE TECHNIC

Neutron spectra determinations for various sources of STIRCA station were made with spheres fitted with lithium iodide crystals.

Fig. 6 and 7 show spectra obtained for graphite sigma pile, at 30 cm and 50 cm front of the pile, for converter, bare or behind shields - 6 cm polyethylene or 30 cm graphite.

On Table I, one can see counting rates for the different spheres diameters, and also deviation with corresponding values calculated from given spectra.

The various spectra for converter can be compared with spectra previously given by G. Benezech (1) using recoil proton proportionnal counter.

For graphite pile, deviation between calculated and measured values are rather important. This emphasize the need of a better precision of response curves for energies lower than 10 keV.

The influence of errors on integral values such as fluences for large energy bands remain rather low as it can be seen from comparison with data from J. Cerf (2) who made in 1970 the sigma pile calibration with activation detectors.

^3He counter under moderating spheres was used for leakage spectra determination near the Vinca RB reactor. In spite of an electronic imperfectly adjusted (PBF1) the results obtained can be regarded as attractive.

The measurements made with Bonner spheres were combined with data provided incidentally by SNAC activation neutron spectrometer.

Spectra were obtained using the model spectra method - minus squares version -.

Table II show measurements results and values calculated from spectra given on fig. 8. It must be noted than for 4 meters measurements, 2 inches sphere was eliminated, using a big precision factor, this data being probably erroneous.

As previously reported (3) there is a discrepancy between sulfur and 12 inches sphere data. Intercalibration between the two detector systems being not yet performed.

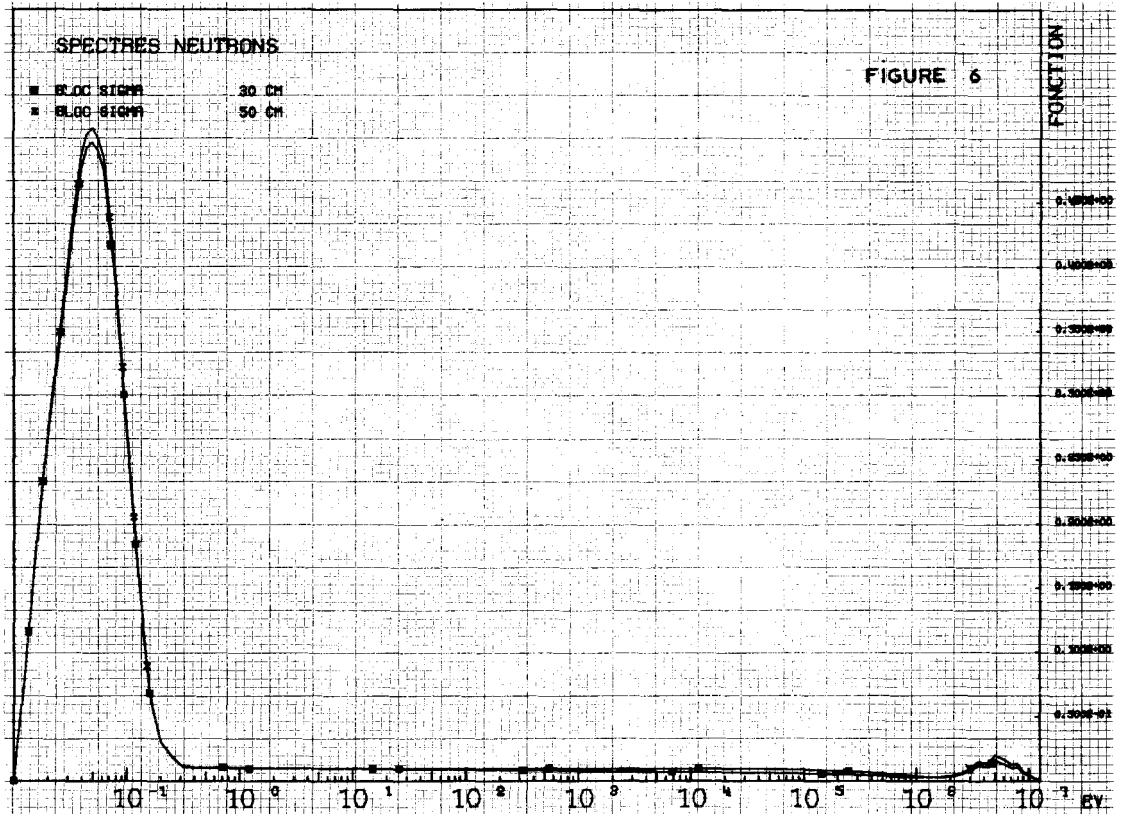



TABLEAU I

Ecart entre les réponses mesurées et calculées par différents spectres

	Σ 30 cm		Σ 50 cm		Convertisseur		Convertisseur + Polyéthylène		Convertisseur + graphite	
	Imp. sec ⁻¹	Ecart	Imp. sec ⁻¹	Ecart	Imp. sec ⁻¹	Ecart %	Imp. sec ⁻¹	Ecart	Imp. sec ⁻¹	Ecart
2"	341	- 4,32	230	- 4,76	0,090	-	0,566	- 3,10	0,134	- 1,28
2"/Cadmium	36,3	- 5,55	23,6	- 9,63	0,078	0,73	0,235	- 1,76	0,097	- 1,69
2,5"	322	- 3,88	198	- 0,54	0,182	-	0,602	3,71	0,172	1,85
2,5/Cadmium	52,6	- 5,69	32,0	- 5,52	0,175	- 1,48	0,334	0,59	0,141	-
3"	299	- 0,92	198	- 0,54						
3"/Cadmium	63,5	0,64	38,6	- 0,78	0,320	- 0,25	0,470	- 2,62	0,190	- 0,97
4,2"	233	3,67	152	3,12						
4,2/Cadmium	77,2	4,99	44,8	5,90	0,666	3,21	0,676	1,18	0,263	- 0,27
5"	190	4,77	122	4,60						
5"/Cadmium	79,0	9,94	44,5	16,2	0,820	- 1,37	0,770	6,26	0,280	5,32
6"	143	8,98	91,2	9,04						
6"/Cadmium	64,2	0,62	38,4	- 2,12	0,857	- 2,20	0,721	- 3,71	0,243	- 2,25
8"	74,0	- 1,06	46,8	- 0,73						
8"/Cadmium	42,6	- 5,67	26,1	- 7,64	0,660	1,69	0,553	- 1,20	0,163	0,88
10"	41,1	- 12,4	27,3	- 14,8						
10"/Cadmium	28,2	- 11,2	184	- 13,8	0,457	- 0,57	0,415	- 2,39	0,113	- 4,72
12"	24,0	2,11	16,2	4,44						
12"/Cadmium	18,5	8,85	12,7	9,53	0,295	-	0,294	2,04	0,711	2,50
Débit de fionce	2,87.10 ³ n.cm ² .s ⁻¹		1,91.10 ³ n.cm ² .s ⁻¹		4,33 n.cm ⁻² . sec ⁻¹		7,21 n.cm ⁻² . sec ⁻¹		1,80 n.cm ⁻² . s ⁻¹	

REACTEUR RB - VINCA

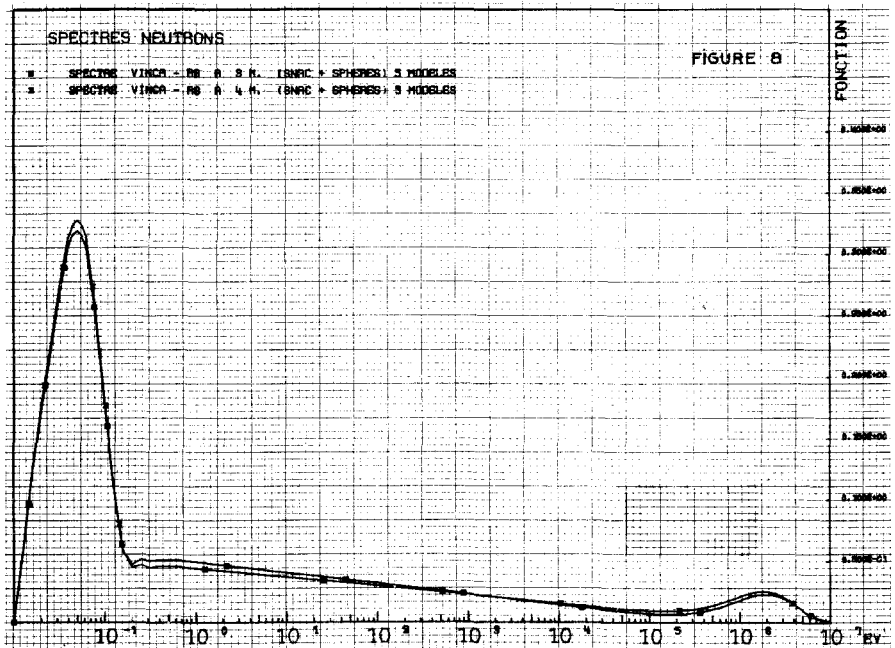
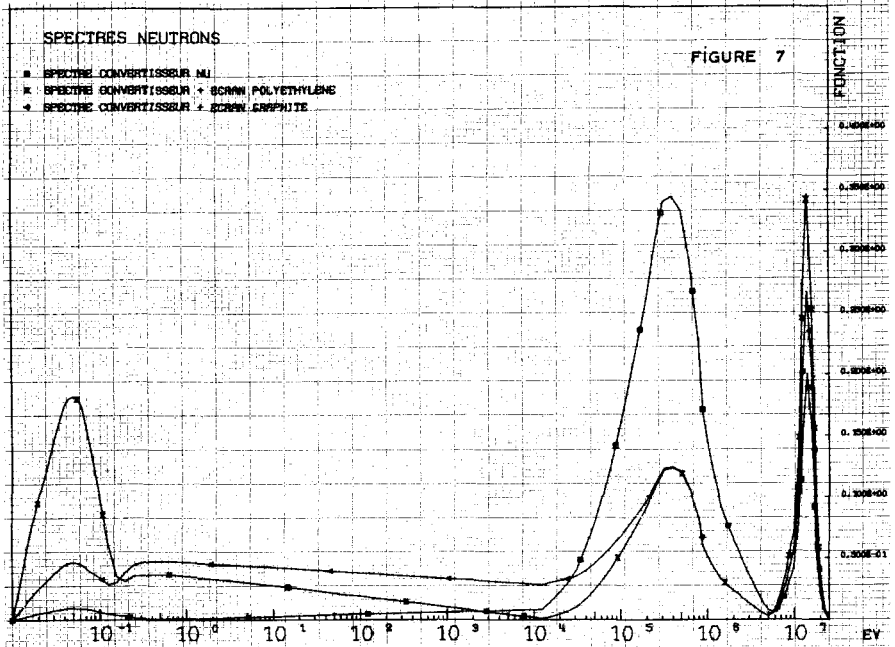
SPECTRE A 3 METRES (SNAC + SPHERES)

DETECTEUR	MESURE	PRECISION	CALCUL	ECART	MODELE	COEFFICIENT
CUIVRE NU	C.61630E 02	0.100E 01	C.575353E 02	-0.695E-01	SPFCTRE MOD. MAXWELLIEN	0.454900E 08
OR /CD 1 N, GAMMA	C.161110E 01	0.100E 01	C.169144E 01	0.437E-01	SPFCTRE K/F	-0.620646E 07
CUIVRE /CC CU(N, GAMMA)CU64	C.268300E 01	0.100E 01	C.371455E 01	0.857E-02	SPFCTRE K/F PERTURBE	0.348064E 08
SOUFRE S32 IN, PJP32	C.164800E 00	0.100E 01	C.136623E 01	-0.171E 00	SPECTRE FISSION	0.379211E 07
MAGNESIUM MG24(N, P)NA24	C.557200E-01	0.100E 01	C.984682E-01	0.307E-01	SPECTRE DE FISSION PERT.	-0.359735E 07
SPHERE 2 POUCEES	C.856400E 07	0.100E 01	C.907160E 07	0.566E-01		
SPHERE 2 POUCEES SOUS CADMIUM	C.224100E 07	0.100E 01	C.325669E 07	0.357E-01		
SPHERE 2,5 POUCEES	C.101540E 08	0.100E 01	C.965399E 07	-0.487E-01		
SPHERE 2,5 POUCEES SOUS CADMIUM	C.456400E 07	0.100E 01	C.4449521E 07	-0.194E-01		
SPHERE 3 POUCEES	C.104740E 09	0.100E 01	C.101115E 09	-0.350E-01		
SPHERE 3 POUCEES SOUS CADMIUM	C.554400E 07	0.100E 01	C.540984E 07	-0.249E-01		
SPHERE 4,2 POUCEES SOUS CADMIUM	C.630000E 07	0.100E 01	C.609780E 07	-0.321E-01		
SPHERE 5 POUCEES SOUS CADMIUM	C.577400E 07	0.100E 01	C.546658E 07	-0.537E-01		
SPHERE 8 POUCEES	C.277000E 07	0.100E 01	C.257037E 07	-0.721E-01		
SPHERE 10 POUCEES	C.166000E 07	0.100E 01	C.165062E 07	-0.119E-01		
SPHERE 12 POUCEES	C.853400E 06	0.100E 01	C.111306E 07	0.246E 00		

REACTEUR RB - VINCA

SPECTRE A 4 METRES (SNAC + SPHERES)

DETECTEUR	MESURE	PRECISION	CALCUL	ECART	MODELE	COEFFICIENT
CUIVRE NU	C.463020E 02	0.100E 01	C.439438E 02	-0.509E-01	SPFCTRE MOD. MAXWELLIEN	0.359229E 08
OR /CD 1 N, GAMMA	C.112690E 01	0.100E 01	C.114305E 01	0.144E-01	SPFCTRE K/F	-0.909255E 06
CUIVRE /CC CU(N, GAMMA)CU64	C.267220E 01	0.100E 01	C.262187E 01	-0.124E-03	SPECTRE K/F PERTURBE	0.214710E 08
SOUFRE S32 IN, PJP32	C.112930E 00	0.100E 01	C.101550E 00	-0.101E 00	SPECTRE FISSION	0.310409E 07
MAGNESIUM MG24(N, P)NA24	C.541400E-01	0.100E 01	C.549303E-01	0.146E-01	SPECTRE DE FISSION PERT.	0.649984E 06
SPHERE 2 POUCEES	C.280400E 07	0.100E 03	C.667887E 07	0.756E 00		
SPHERE 2 POUCEES SOUS CADMIUM	C.142300E 07	0.100E 03	C.234111E 07	0.64E 00		
SPHERE 2,5 POUCEES	C.724100E 07	0.100E 01	C.708108E 07	-0.221E-01		
SPHERE 2,5 POUCEES SOUS CADMIUM	C.222900E 07	0.100E 01	C.316986E 07	-0.186E-01		
SPHERE 3 POUCEES	C.720700E 07	0.100E 01	C.741310E 07	0.286E-01		
SPHERE 3 POUCEES SOUS CADMIUM	C.265600E 07	0.100E 01	C.385769E 07	0.552E-01		
SPHERE 4,2 POUCEES SOUS CADMIUM	C.467200E 07	0.100E 01	C.445811E 07	-0.458E-01		
SPHERE 5 POUCEES SOUS CADMIUM	C.429400E 07	0.100E 01	C.405466E 07	-0.557E-01		
SPHERE 8 POUCEES	C.206900E 07	0.100E 01	C.198309E 07	-0.382E-01		
SPHERE 10 POUCEES	C.131000E 07	0.100E 01	C.129531E 07	-0.481E-01		
SPHERE 12 POUCEES	C.726600E 06	0.100E 01	C.872184E 06	0.200E 00		

TABLEAU II

Kernforschungsanlage Jülich GmbH, Zentralabteilung Strahlenschutz, D 517 Jülich,

Vertrag Nr. O65-72-1 PSTC

M. Heinzelmann

Neutron dosimetry with fission track counters and moderator spheres

The work is concerned with two different types of neutron dosimeters. One type is the frequently used method of Bonner in measuring neutrons with moderating spheres, which is implemented with many variants. This is to be investigated systematically in order to take into account the influence of different constituents on the efficiency and energy dependence. The aim is to build a new, low-weight rem-counter. The other type is a highly sensitive fission-track-counter with a large surface area. Such a one has been built and tried in field experiments. Once more the aim is an improvement of neutron dosimetry.

During the year the relative sensitivity of the Bonner-counter has been measured for different types of central detectors. They have been accompanied by Monte Carlo calculations for three different sphere diameters. The measurements of the influence of the detector-connection on the sensitivity and directional dependence have been continued.

The Thorium- and Bismuth-fission track counters, which had been developed the year before, have been tried for the dosimetry of high energy neutrons behind the shielding of an isochronzyklotron.

Neutron dosimetry with fission track counters and moderator spheres

a) Investigation with sphere counters.

The energy dependance of neutron sphere counters has been checked against the type of detector in the sphere counter. The measurements have been done with three different LiJ(Eu) scintillators. As neutron sources an Am-Be and an Am-Li source have been used with a mean energy of $E = 4,4$ MeV and $E = 0,5$ MeV. Further results have been achieved with a configuration of the Am-Be-source within a polyethylen-cylinder which was covered by Cd or In for thermal neutrons and neutrons of about 1,2 eV. It could be proved that for moderating spheres upwards 3" diameter the energy dependence of the sensitivity of the dosimeter is independent from the detector in the center of the ball. This agrees with the accompanying calculations. Only for the detectors within the 2" moderating sphere a considerable variation of the energy dependence of the sensitivity with the type of the detector has been found. This amounts for up to 50 per cent.

New Monte-Carlo calculations have been made to accompany the measurements. A first Monte Carlo program builds up a file which holds data of neutrons which have passed a characteristic inner sphere of the moderator. A second Monte Carlo program calculates the interaction with different detectors from the first file. By this method the responses of three different spheres with four different detectors have been evaluated. There is only a small dependence on the detector in the moderator spheres.

The directional^{dependance} of the ball counter with different lucite and quartz light pipes has been measured with different neutron energies. While the dosimeter is quite isotopic for neutrons of the Am-Be-source, there are great differences for smaller energies. For instance with a 10"

moderating sphere and a quartz light pipe of 12 mm diameter covered with 2 mm Aluminum the sensitivity was too high by 73 per cent for neutrons of the Am-Li-source impinging from large angles. These measurements disprove statements found in the literature that detector readings with moderating spheres should be isotropic.

The measurements to investigate the influence of the detector mounting on the sensitivity of the sphere counter have been continued. Great differences have been detected for an equipment with a multiplier directly connected with a scintillator in the ball center; these amount to up to 30 per cent with a 7" ball.

b) Fission track dosimetry

Thorium- and Bismuth-fission track counters have been field tested behind the shielding of the isochron-cyclotron at Jülich, which operates with a maximum deuteron energy of 90 MeV. From the detector readings the dose equivalent of the neutrons within the energy range from 2 to 10 MeV and above 10 MeV has been calculated with quite different neutron energy spectra. The dose due to neutrons above 10 MeV amounted to only between 1 and 16 per cent of the dose equivalent of neutrons of the energy range between 2 and 10 MeV. The variation of this percentage accrues from different supposed energy spectra. Anyway the measurements prove that in this particular case the dose equivalent of the neutrons with energies above 10 MeV is quite small. Independently from the supposed energy spectrum the value of the dose equivalent of all neutrons above an energy of 2 MeV was identical within 10 per cent.

Measurements with a sphere counter of 12" diameter and a multi-sphere-method by use of a 18" moderating sphere for the energy range up to 50 MeV suggests, that in this particular case the neutrons of an energy upwards from 10 MeV might have contributed with 80 per cent to the dose equivalent. This apparent contradiction can be explained

by the oversensitivity of the multi-sphere-method in the energy-range from 3 to 6 MeV.

The results show that measurements with the multi-sphere-method allow only a very erroneous conclusion about the account of high energy neutrons in the measured field.

Publications:

F.Rohloff, M.Heinzelmann:

Influence of detector type and equipment on the sensitivity of Bonner spheres

in: Neutron Monitoring for Radiation Protection Purposes
Vol.1, p 269, Vienna 1973

M.Heinzelmann, H.Schüren:

Erfahrungen mit großflächigen Spaltfragmentdosimetern

in: Jül-952-ST, p. 99 (1973).

GESELLSCHAFT FÜR STRAHLEN- UND UMWELTFORSCHUNG MBH, MÜNCHEN
Institut für Strahlenschutz, Neuherberg

Vertrag Nr.: 065-72-1 PSTC

Leiter der Forschungsgruppe:

Prof. Dr. F. Wachsmann und Dr. G. Burger

Allgemeines Thema des Vertrages:

Personendosimetrie und Kalibriertechnik im Neutronenstrahlenschutz

Die Gruppe befaßte sich mit Problemen der Fortentwicklung von Personendosimetriemethoden, der Bestimmung von Neutronenquellstärken und Neutronenfeldern sowie der Entwicklung verbesserter Spektrometriemethoden.

Mit Hilfe eines Neutronentransportcodes wurden die Eigenschaften eines Albedodosimeters mit thermischem Detektor untersucht. Da jetzt die Herstellung dünner Folien aus Np-Al-Legierungen möglich geworden ist, konnten die Arbeiten am Spaltfragmentdosimeter fortgesetzt werden.

Die Kalibriereinrichtungen in der streustrahlarmen Halle der GSF wurden vervollständigt und stehen den Mitgliedern der Gemeinschaft zur Verfügung.

Weiterhin wurde ein Rückstoßprotonen-Gasteleskop entwickelt und gebaut, welches die Messung von Neutronenfeldern im Energiebereich unterhalb etwa 1 MeV ermöglicht.

Ergebnisse des Projektes

Leiter des Projektes und wissenschaftliche Mitarbeiter:

H. Schraube, H. Borst, F. Grünauer und K. Kolbe

Titel des Projektes: Personendosimetrie und Kalibriertechnik

Für die Personendosimetrie wurde die Verwendbarkeit des seit einiger Zeit diskutierten Albedo-Dosimeters theoretisch untersucht. Mit Hilfe des Neutronentransportprogrammes DØT wurde eine Modellberechnung durchgeführt für den Fall, daß ein zylindersymmetrisches Phantom mit Neutronenparallelfeldern unterschiedlicher spektraler Verteilungen bestrahlt wird und die thermische Komponente des Streufeldes gemessen wird (Fig.1). Als Ergebnis zeigt Fig. 2 die thermische Flußdichte bezogen auf eine einfallende Flußdichte von $1 \text{ n/cm}^2\text{s}$ in der Umgebung des Phantoms für 3 spektrale Verteilungen. Es ist zu ersehen, daß die Anzeige eines thermischen Detektors sehr stark von der spektralen Verteilung der einfallenden Neutronen abhängt. Die Anisotropie des Körper-Dosimetersystems ist für die drei Spektren erheblich, dagegen spielt die Änderung der Flußdichte mit dem Abstand vom Körper für die betrachteten Fälle eine vergleichsweise geringe Rolle.

Die Verwendung von Folien aus Np-237-Al-Legierungen als Konverter in Spaltspurdetektoren verspricht wegen der niedrigen Schwellenergie des Np-237 eine Vergrößerung des erfaßbaren Energiebereiches in Personendosimetern. Zur Verfügung standen vorläufig 0.2 mm dicke Folien im Konzentrationsbereich von 0.15 bis 1%. Als Auffänger dienten 10µ Polykarbonatfolien, die darin entstandenen Spaltfragmentätzlöcher wurden mit dem Funkenzähler ausgezählt. Die Detektoren wurden an einer Cf-252-Quelle kalibriert. Die Empfindlichkeit betrug z.B. bei einer Konzentration von 0.15% etwa $1.5 \text{ Spuren/rad cm}^2$, der meßbare Dosisbereich lag für die verwendete Auswertemethode und den angegebenen Konzentrationsbereich zwischen 1 und 500 rad.

An der in der Neutronenmeßhalle fertiggestellten Stahlführung des 3 MeV-Generators der GSF wurden erste Kalibriermessungen vorgenommen. Die Absolutausbeuten aus einigen Targetreaktionen

wurden mit dem Precision-Long-Counter bestimmt und die spektralen Verteilungen mit dem Szintillationspektrometer gemessen. Die Kalibriereinrichtungen stehen jetzt für Vergleichsprogramme der Gemeinschaft zur Verfügung.

Die im Rahmen eines Vergleichsprogrammes der Gemeinschaft durchgeführten Quellstärke- und Spektrumsmessungen wurden abgeschlossen. Die mit dem $MnSO_4$ -Bad und dem PLC gewonnenen Ergebnisse der Quellstärken lieferten gute Übereinstimmung. Durch die große Ausdehnung der streustrahlarmen Halle war es möglich mit dem PLC auch Quellstärken von mehr als 10^9 1/s zu bestimmen.

Für die Spektrometrie von Neutronen im Energiebereich unterhalb etwa 1 MeV wurde ein Rückstoßprotonen-Gasteleskop entwickelt und aufgebaut. Es besteht aus einem Proportionalzählrohr das in drei Koinzidenz-Abschnitte unterteilt ist und von einem Antikoinzidenzvolumen umgeben ist. Durch die geeignete Dimensionierung der Volumina konnte das Spektrometer weitgehend unempfindlich gegen γ -Untergrund, schwere Rückstöße und unter großem Winkel gestreute Rückstoßprotonen gemacht werden. Für die Bestimmung der Empfindlichkeitsfunktionen wurde ein Monte-Carlo-Programm entwickelt, und für die Berechnung des Feldlinienverlaufes ein Rechnerprogramm auf der Basis der konformen Abbildung geschrieben.

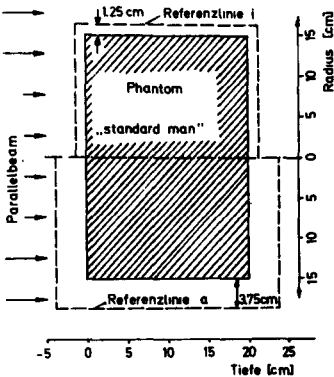

Fig. 1

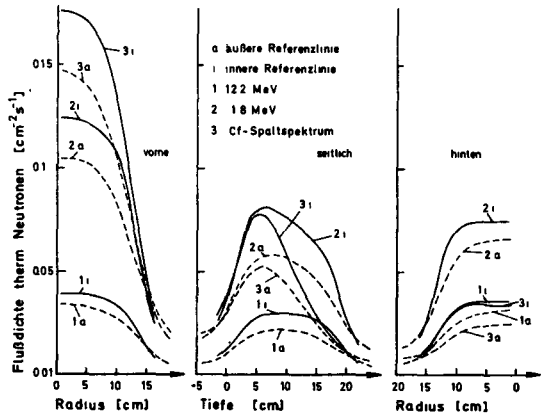

Fig. 2

Bericht:

H. Borst, G. Burger, J. David, F. Grünauer, K. Kolbe und H. Schraube, Dosimetrie und Kalibriermeßtechnik
 Jahresbericht zum Vertrag O65-72-1 PSTC, September 1973

Vertragspartner der Kommission: Bundesforschungsanstalt
für Lebensmittelfrischhaltung, Karlsruhe

Nr. des Vertrags: 047-69-4 PST C

Leiter der Forschungsgruppe: Prof. Dr. J.F. Diehl

Allgemeines Thema des Vertrags: Meßbare Veränderungen in
bestrahlten Lebensmitteln

Im Jahr 1973 sind weitere Genehmigungen für die Lebensmittelbestrahlung erteilt worden - so in Italien für die Bestrahlung von Kartoffeln, Zwiebeln und Knoblauch. Eine EWG-Richtlinie für die Zulassung der Kartoffelbestrahlung in den Mitgliedsländern der Europ. Gemeinschaft ist in Vorbereitung. Die mit der Lebensmittelüberwachung beauftragten Stellen sind daher an der Entwicklung von Methoden, die eine Unterscheidung bestrahlter von unbestrahlten Lebensmitteln gestatten, sehr interessiert.

Abgesehen vom Problem der Überwachung interessiert die Untersuchung der durch die Bestrahlung in Lebensmitteln verursachten chemischen und physikalischen Veränderungen auch im Hinblick auf toxikologische und technologische Fragen. Ziel der in Teil B beschriebenen Arbeiten war einerseits die Prüfung verschiedener analytischer Methoden auf ihre Eignung zum Nachweis einer erfolgten Bestrahlung von Lebensmitteln und andererseits die Vertiefung der Kenntnisse über die strahleninduzierten Veränderungen in Lebensmitteln.

Die seit 1967 laufenden Arbeiten wurden im Jahr 1973 abgeschlossen. Die Ergebnisse wurden im Rahmen eines gemeinsam von der Direktion Gesundheitsschutz und der Bundesforschungsanstalt für Lebensmittelfrischhaltung am 24./25. Oktober 1973 in Karlsruhe veranstalteten Internationalen Kolloquiums zusammenfassend vorgetragen. Alle Referate und Diskussionsbeiträge dieses Kolloquiums werden von der Kommission der EG in einem Sammelband veröffentlicht. Die folgenden Berichte (Teil B) sind daher sehr kurz gefaßt.

Ergebnisse des Projekts Nr. 1

Leiter des Projekts: Dr. H. Scherz, Bundesforschungsanstalt für Lebensmittelfrischhaltung, Karlsruhe

Titel: Elektrische Leitfähigkeit

Die in den vorangegangenen Jahren entwickelte Methode zur Erkennung bestrahlter Kartoffeln anhand von Messungen der elektrischen Leitfähigkeit wurde an verschiedenen Kartoffelsorten und nach Lagerung unter verschiedenen Bedingungen weiter erprobt und ihre allgemeine Anwendbarkeit bestätigt.

Nachdem in den eigenen Untersuchungen nur eine einfache Wechselstrombrücke für die Widerstands- bzw. Leitfähigkeitsmessungen verwendet worden war, konnte in Zusammenarbeit mit dem Rijks Instituut voor de Volksgezondheit in Bilthoven festgestellt werden, daß sich der Bestrahlungseffekt mit Hilfe eines automatischen Leitfähigkeitsmeßgerätes mit registrierendem Schreiber noch deutlicher nachweisen läßt. Im Gegensatz zu zeitaufwendigen histologischen und enzymatischen Methoden ist die Leitfähigkeitsmethode die einzige, die eine Unterscheidung bestrahlter von unbestrahlten Kartoffeln innerhalb von Minuten gestattet.

Veröffentlichungen:

H. Scherz: Conductivity measurements as a method for differentiation between irradiated and nonirradiated potatoes.
EURATOM Bericht, EUR 4953 e, 1973

Ergebnisse des Projekts Nr. 2

Leiter des Projekts: Dr. H. Scherz, Bundesforschungsanstalt für Lebensmittelfrischhaltung, Karlsruhe

Titel: Chromatographie und Kolorimetrie

In bestrahlter Stärke lassen sich 1,4-Pyrone ab einer Dosis von etwa 100 krad dünnschichtchromatographisch nachweisen. Als Hauptsubstanz

konnte Hydroxymaltol identifiziert werden. Seine Entstehung scheint strahlenspezifisch zu sein - in erhitzter Stärke konnte es jedenfalls nicht gefunden werden. Der Nachweis des Hydroxymaltols erfüllt somit die Voraussetzungen für die eindeutige Identifizierung bestrahlter Stärke. In kohlenhydrathaltigen Lebensmitteln, die Proteine enthalten, läßt sich die strahleninduzierte Bildung von Hydroxymaltol erst nach Anwendung höherer Strahlendosen nachweisen - in Weizenmehl ab 1 Mrad. Nach der Bestrahlung nimmt die Hydroxymaltolkonzentration noch zu: un- mittelbar nach Bestrahlung mit 1 Mrad wurden in Weizenmehl 0.07 mg/ 100 g gefunden, nach 32 Tagen 0.15 mg/100 g. Erhitzen beschleunigt die- sen Vorgang. In bestrahltem Milchpulver konnte selbst bei einer Dosis von 5 Mrad keine Hydroxymaltolbildung beobachtet werden.

Veröffentlichungen:

H. Scherz: Die Bildung von 1,4-Pyronen bei der Radiolyse von Stärke.
Z. Naturforschg., 28 c (1973) 14 - 19

Ergebnisse des Projekts Nr. 3

Leiter des Projekts: Dr. B.J. Radola, Bundesforschungsan-
stalt für Lebensmittelfrischhaltung, Karlsruhe

Titel: Chromatographie, isoelektrische Fokussierung und
Enzymanalyse

Die Versuche, die in Sarkoplasmaproteinen von Rindfleisch nach Bestrah- lung mit höheren Dosen mit Hilfe der Dünnschicht-Gelchromatographie und der dünn- schicht-isoelektrischen Fokussierung festgestellten Veränderun- gen auch im niedrigeren Dosisbereich (unter 1 Mrad) nachzuweisen, wurden fortgesetzt. Dabei wurde vor allem mit fluorogenen Substraten gearbeitet, wobei sich Fluorescein-diacetat und -dilaurat als besonders geeignet für den Nachweis der Esterasen bzw. Lipasen erwiesen haben. Bei der Dün- nschicht-Gelchromatographie auf Sephadex G-200 findet man mit diesen Sub- straten im Trennmuster der Sarkoplasmaproteine aus bestrahltem Fleisch eine neue, strahleninduzierte Fraktion enzymatisch aktiver Aggregate, die mit einem R_M -Wert von 2,4 wandert. Fleisch, das mit einer Dosis von

1 Mrad oder höher bestrahlt ist, läßt sich auf diese Weise eindeutig identifizieren. Geringe Mengen der strahleninduzierten enzymatisch aktiven Aggregate treten bereits nach Bestrahlung mit 0.25 und 0.5 Mrad auf. Es ist bisher nicht gelungen, diese enzymatisch aktiven Aggregate durch eine Ammoniumsulfatfällung oder über Ultrafilter mit abgestuften und definierten Abscheidungsgrenzen (Diaflo-Membranen, Amicon) anzureichern, was eine Voraussetzung dafür wäre, auch bei mit Dosen von unter 1 Mrad bestrahltem Fleisch zu eindeutigen Aussagen zu gelangen.

In den bisher beschriebenen Untersuchungen wurden nur die bei geringer Ionenstärke löslichen Sarkoplasmproteine eingesetzt. Strahleninduzierte Veränderungen an den unlöslichen bzw. durch die Bestrahlung insolubilisierten Proteinen werden dabei nicht erfaßt. Früher durchgeführte Solubilisierungsversuche mit Harnstoff führten nicht zu befriedigenden Ergebnissen. Neue Versuche mit Natriumdodecylsulfat (SDS) als Lösungsmittel verliefen nicht erfolgreicher. Mit Hilfe der SDS-Elektrophorese werden zwar gut differenzierte Trennmuster der Fleischproteine erhalten, sie zeigen jedoch im Dosisbereich unter 1 Mrad keine strahleninduzierten Veränderungen.

Ergebnisse des Projekts Nr. 4

Leiter des Projekts: Prof. Dr. F. Drawert, Institut für chemisch-technische Analyse und chemische Lebensmitteltechnologie der Technischen Universität München

Titel: Gaschromatographie und Massenspektrometrie

Mittels Gaschromatographie/Massenspektrometrie wurden in bestrahlten oder erhitzten Fetten (Schweinefett, Olivenöl, Sonnenblumenöl u.a.) und in geräuchertem Schinken folgende Kohlenwasserstoffe gefunden:

Bestrahlung 0,5 - 6 Mrad	Erhitzen 24 Std., 170° C	äußere Schichten von Räucherschinken
1. Octan	1. Octan	1. Nonan
2. Octen	2. Nonan	2. Nonen
3. Nonan	3. Nonen	3. Decan
4. Nonen	4. Decan	4. Decen
5. Decan	5. Decen	5. Undecan
6. Decen	6. Undecan	6. Undecen
7. Undecan (4 Isomere)	7. Undecen	7. Dodecan
8. Undecen	8. Dodecan	8. Dodecen
9. Dodecan	9. Dodecen (2 Isomere)	9. Tridecan
10. Dodecen (2 Isomere)	10. Tridecan	10. Tridecen
11. Tridecan	11. Tridecen (2 Isomere)	11. Tetradecan
12. Tridecen (2 Isomere)	12. Tetradecan	12. Tetradecen
13. Tetradecan	13. Tetradecen (2 Isomere)	13. Pentadecan
14. Tetradecen (2 Isomere)	14. Pentadecan	14. Pentadecen
15. Tetradecadien	15. Pentadecen (2 Isomere)	15. Hexadecan
16. Pentadecan	16. Hexadecan	16. Hexadecen
17. Pentadecen	17. Hexadecen (2 Isomere)	17. Heptadecan
18. Pentadecadien	18. Heptadecan	18. Heptadecen
19. Hexadecan	19. Heptadecen	19. Octadecan
20. Hexadecen	20. Heptadecadien	20. Octadecen
21. Hexadecadien	21. Octadecan	
22. Hexadecatrien	22. Octadecen	
23. Heptadecan	23. Äthylcyclohexen	
24. Heptadecen (2 Isomere)	24. Propylcyclohexen	
25. Heptadecadien	25. Butylcyclohexen	
26. Heptadecatrien	26. Pentylcyclohexen	
27. Octadecan	27. Hexylcyclohexen	
28. Octadecen	28. Heptylcyclohexen	

Von den durch Bestrahlung gebildeten 28 Kohlenwasserstoffen traten demnach 6 in erhitztem Fett nicht auf. Letzteres enthielt 6 Cyclohexene, die in bestrahlten Fetten nicht nachweisbar waren. Neben den

Kohlenwasserstoffen lassen sich auch Sauerstoffverbindungen nachweisen - z.B. in mit 6 Mrad bestrahltem Schweinefett 4 Alkohole, 11 Aldehyde und 4 Ketone neben 9-Oxononansäure.

Auch die Untersuchungen über die beim Bestrahlen und Erhitzen von reinen Triglyceriden gebildeten Reaktionsprodukte wurden fortgesetzt. Tripalmitat liefert sowohl beim Bestrahlen als beim Erhitzen Pentadecan und Tetradecan als Hauptkomponenten. Tristearat bildet unter den gleichen Bedingungen hauptsächlich Heptadecan und Hexadecan. Im Triooleat dagegen entsteht bei der Bestrahlung vor allem Hexadecadien und Heptadecen, beim Erhitzen Butylcyclohexen, Heptylcyclohexen und Heptadecen.

Ergebnisse des Projekts Nr. 5

Leiter des Projekts: Dr. H. Penner, Bundesforschungsanstalt für Lebensmittelfrischhaltung, Karlsruhe

Titel: Mikrostruktur, Chromatographie

Im Rahmen der Untersuchungen über die Wirkung einer Bestrahlung auf Stoffwechselforgänge in Kartoffelknollen wurde die Katalaseaktivität in frischem und in 5 Tage inkubiertem Gewebe gemessen. Es konnte kein signifikanter Einfluß der Bestrahlung (Dosis 15 krad) festgestellt werden. Es wurden starke sortenabhängige Schwankungen der Katalaseaktivität beobachtet.

Um die Brauchbarkeit verschiedener Methoden zur Identifizierung bestrahlter Kartoffeln im Blindversuch zu prüfen, wurden teils bestrahlte, teils chemisch keimgehemmte Kartoffeln aus den Niederlanden (IBVL Wageningen) bezogen. Nach folgenden Methoden wurde beurteilt, ob die Proben bestrahlt waren oder nicht:

1. Wundperidermbildung
2. Elektrische Leitfähigkeit
3. Chlorogensäuresynthese
4. Phenylalaninammonialyase-Aktivität.

Eine sichere Identifizierung gelang nur mit den Methoden 1 und 2. Bei der Beurteilung lange gelagerter Kartoffeln (Ende Mai) trat auch bei diesen Methoden eine erhebliche Fehlerquote auf.

Veröffentlichungen:

- 1) H. Penner: Versuche zum Nachweis einer erfolgten Bestrahlung von Kartoffeln. III. Die Wirkung von Röntgenstrahlen auf die Chlorogensäurebiosynthese in der Kartoffelknolle.
Potato Research 16 (1973) 171
- 2) S. Shirsat und H. Penner: Versuche zum Nachweis einer erfolgten Bestrahlung von Kartoffeln. IV. Die Wirkung von Röntgenstrahlen auf die Bildung von Phenylalaninammonialyase in Kartoffeln.
Z. Lebensmittel-Unters. -Forschg. 151 (1973) 167
- 3) H. Penner: Versuche zum Nachweis einer erfolgten Bestrahlung von Kartoffeln. V. Kalorimetrische Katalasebestimmung.
Z. Lebensmittel-Unters. -Forschg., im Druck.

Results of the project No. 047-69-4 PSTC

Head of the team/scientific coworkers: L.Strackee

D.Onderdelinden

National Institute for Public Health,
Bilthoven, Holland

Title of the project: A. Detection of irradiated foodstuffs
by means of electron spin resonance.
B. Conductivity changes in potatoes
induced by ionizing radiation.

Description of the results obtained in the period Jan 1 - Dec 31 1973

A. The investigations performed during the above mentioned period were mainly concentrated on ESR measurements of irradiated fats and bones. Irradiation (Co^{60}) of frying fat, lard, bacon, fatty parts of beef and pork were performed both at room temperature and at liquid nitrogen temperature. The electron spin resonance spectra of all the samples irradiated and measured at liquid nitrogen temperature were rather unresolved and diminish gradually in intensity on heating. At about $-50^{\circ}C$ the spectrum changes into that observed at room temperature. The unresolved spectrum is due to a large number of unstable primary radicals, thus making detailed assignment of the spectrum not possible. The spectra obtained at room temperature are similar for all samples and has the form of a septet with a hyperfine splitting of about 16 gauss. The line width is 9 gauss. From measurements on saturated and unsaturated triglycerides it was concluded that the septet spectrum found in fats is mainly due to free radicals in the triglycerides containing unsaturated fatty acids. The septet spectrum then is assigned to an unpaired electron near the double bond as a conjugated free radical. The stability of the radical was determined at room temperature both in an air atmos-

phere and in an argon atmosphere. After the initial decrease the decay seems to be governed by first order kinetics. The half value time in both cases is about the same and is estimated as 15 days.

The radical yield at room temperature of some fats was determined and found to be in the order of 0.5 spins/100 eV.

Measurements of the ESR spectrum of bone samples were performed both at room temperature and at liquid nitrogen temperature. At room temperature in vacuum the spectra of bone samples of different origin all showed a doublet with a splitting of 12.5 gauss and a linewidth of about 8 gauss. On admission of air the spectra changes to a singlet type spectrum. The doublet spectrum was assigned to a radical induced by the irradiation in the collagenous fibers of the bone material. An unpaired electron attached to the α carbon at the carboxyl end of polyglycine molecules is responsible for the observed spectrum.

The radical yield at room temperature of some bone samples was estimated as approximately 0.02 spins/100 eV.

B. Measurements of the electrical conductivity changes of potato material after irradiation with γ -rays, 10 MeV- and 3 MeV electrons up to doses of 100 krad were performed to corroborate similar work performed at Karlsruhe. The general aspects of the work of Scherz on conductivity measurements as a method for differentiation between irradiated and non irradiated potatoes were confirmed. Furthermore it was found that the observed effects were independent of the type of irradiation. Frequency dependent measurements in the range 50 Hz - 50 kHz were performed. The frequency dependence of the real and imaginary part of the conductance can be understood if it is assumed that the irradiation

mainly affects the electrical properties of the cell membrane.

The behaviour of the electrical conductivity upon probe insertion directly after a short irradiation at high dose rate did not differ in irradiated and non irradiated potatoes. The effect showed up only after one day indicating that the changes of the membrane conductivity are not due to the primary damage but are caused by subsequent change in the cell enzyme activity.

Publications in 1973

D.Onderdelinden and L.Strackee, ESR study of irradiated plastics,
Eur 4920 e, 1973

D.Onderdelinden and L.Strackee, "ESR as a tool for the identification
of irradiated material".

R.van Dongen, D.Onderdelinden and L.Strackee, "Additional measurements
of conductivity changes in potatoes
induced by ionizing radiation"

(The last two papers were presented at the international colloquium
on "The identification of Irradiated Foodstuffs", Karlsruhe, 24 and
25 October 1973)

Contrat n° 047 - 69 - 4PSTC

Institut d'Hygiène et d'Epidémiologie
Rue Juliette Wytsman 14
1050 BRUXELLES (Belgique)
Directeur : Prof. Dr. A. LAFONTAINE

Chefs des groupes de recherche : L. BUGYAKI
M. VANDER STICHELEN ROGIER

IDENTIFICATION DES ALIMENTS IRRADIES AUX RAYONS GAMMA

1. Utilisation de techniques électrophorétiques en vue de l'identification de certaines denrées irradiées.
(M. Vander Stichelen Rogier)

Les aliments suivants ont été étudiés :

- viande de boeuf crue, irradiée à la température ambiante (0, 0.5 et 5 Mrad)
- viande de boeuf chauffée à 71°C afin d'inhiber l'activité des enzymes protéolytiques et irradiée à la température de - 30°C (0 et 5 Mrad)
- filets de cabillaud irradiés à la température ambiante (0 et 1 Mrad)
- crevettes grises cuites et décortiquées (0 et 200 krad).

Pour chacun des échantillons on a extrait successivement :

- les protéines sarcoplasmiques solubles dans un tampon de faible force ionique
- les protéines solubles dans le tampon Weber-Edsall (protéines myofibrillaires)
- les protéines résiduelles solubles dans une solution d'urée 8 M contenant $5 \cdot 10^{-3}$ M de 1,4-dithioérythritol (DTE).

L'étude des protéines sarcoplasmiques a fait l'objet de rapports antérieurs.

./..

Les deux autres extraits protéiques provenant des échantillons irradiés et non irradiés (témoins) ont été analysés par électrophorèse et par focalisation isoélectrique, en gels de polyacrylamide.

Pour les échantillons de viande crue, on a constaté, dans la séparation des protéines des extraits Weber-Edsall, que pour la dose 5 Mrad il y avait disparition de nombreuses zones colorées qui apparaissent dans le cas du témoin non irradié, vers les faibles mobilités électrophorétiques. Ceci est apparent également en focalisation isoélectrique dans un gradient de pH 3-10. Pour les extraits dans l'urée-DTE les séparations sont caractérisées par un fond continu coloré pour l'extrait 5 Mrad. En focalisation isoélectrique l'interprétation est plus difficile en raison de la multiplicité des zones colorées.

Pour les trois échantillons de viandes chauffées (viande chauffée à 71°C - viande stérilisée thermiquement - viande chauffée à 71°C et irradiée), l'extraction des protéines sarcoplasmiques a conduit à l'obtention d'une solution de couleur rosée pour la viande chauffée à 71°C, indiquant qu'une partie des myoglobines existait toujours, ce qui n'est plus le cas pour les deux autres échantillons.

L'extraction au moyen du tampon Weber-Edsall n'a conduit qu'à une faible solubilisation des protéines myofibrillaires contrairement à ce qui se passe dans le cas des viandes crues. L'électrophorèse de ces extraits n'a pas montré de différences significatives entre les trois extraits. Par contre, dans le cas des extraits urée-DTE, l'électrophorèse montre une différence non équivoque entre l'extrait de la viande stérilisée thermiquement et les deux autres, l'extrait de viande irradiée se différenciant, en plus, de celui de la viande non irradiée par une zone colorée diffuse en dessous du "spacer gel".

La séparation des extraits Weber-Edsall du cabillaud n'a pas montré de différences suffisantes entre échantillons irradiés et témoins que pour prouver l'irradiation.

./..

De même, dans le cas des extraits Weber-Edsall et urée-DTE des crevettes, la focalisation isoélectrique dans un gradient de pH 3-10 n'a pas indiqué de différences entre l'échantillon irradié et le témoin.

2. Identification des champignons irradiés.

(L. BUGYAKI)

Différents milieux de culture (à base d'agar), coulés dans les boîtes de Pétri, sont ensemencés au moyen de boutures prélevées dans la chair piléique de champignons frais non irradiés et de champignons irradiés (50, 100, 150, 200 et 250 krad de rayons gamma d'une source de ^{60}Co). Les boîtes ensemencées sont incubées à 25°C. L'examen microscopique révèle souvent, déjà après 8 h. d'incubation, la prolifération de filaments (hyphes) en plusieurs endroits de la bouture s'il s'agit de champignons frais non irradiés. Pour les champignons non irradiés il y a toujours développement visible après 24 h. d'incubation même si le champignon a été conservé en réfrigérateur. En ce qui concerne les champignons irradiés, on voit apparaître, un peu plus tardivement (24-48h.) des hyphes sur les boutures provenant de champignons irradiés à 50 ou 100 krad. Par contre si l'irradiation dépasse 150 krad il n'y a plus aucune manifestation de multiplication cellulaire. On dispose ainsi d'un moyen simple et peu coûteux pour identifier les champignons irradiés.

PUBLICATION : L. BUGYAKI et M. VANDER STICHELEN ROGIER

Rapport Eur. 4878 (1973)

Immunoélectrophorèse et électrophorèse verticale en gel d'amidon des protéines de la viande, du poisson et de l'oeuf entier, irradiés aux rayons gamma.

Contractant de la Commission : CENATRA

Numéro du contrat : 047-69-4-PSTC

Directeur des recherches : Prof. Ir. A.R. Deschreider

Sujet général du contrat : La détection de l'irradiation
des denrées alimentaires.
(Travaux exécutés en 1973).

On a étudié les modifications provoquées par les rayons gamma lors de l'irradiation de fraises, de crevettes et de cabillaud. Ceci afin d'examiner les possibilités éventuelles de détection du traitement. En ce qui concerne les fraises et le cabillaud, on a également procédé à l'examen des matières plastiques constituant l'emballage. En effet, les polymères examinés en infrarouge, après traitement par les rayons gamma, présentent bien souvent des bandes d'absorption différentielles.

Ce phénomène est sous la dépendance de la dose appliquée, de la nature du polymère et de son épaisseur.

De plus, certaines matières plastiques révèlent dans le proche infrarouge des effets hypsochromes et bathochromes dus à l'irradiation.

En ce qui concerne les fraises on a examiné en particulier, la répercussion du traitement sur les anthocyanes et sur l'activité de la phénylalanine-ammonialyase.

Pour les crevettes, les essais ont porté sur l'astacène, la spectropolarimétrie et la spectrophotométrie infrarouge des protéines.

Enfin, pour le cabillaud, diverses techniques à l'infrarouge, furent essayées.

x

x

x

Résultats du projet n° O47-69-4-PSTC.

Directeur des recherches et collaborateur scientifique:

Prof. Ir. A.R. Deschreider et Dr.Sc. J.M.Vigneron.

Titre du projet : La détection de l'irradiation des denrées alimentaires.

a) Crevettes.

L'indice d'acide thiobarbiturique (TBA) donné par la valeur $(E_{552nm} - E_{454nm})$ bien qu'influencé par l'irradiation donne des écarts trop faibles que pour permettre la distinction entre échantillons irradiés et non-irradiés.

Le spectre de l'astacène est affaibli par une dose de 500 Krad et l'indice d'astacène donné par le rapport $\frac{DO_{475nm}}{DO_{390nm}}$

présente des variations irrégulières de telle sorte qu'il ne peut servir de moyen de détection.

Les courbes spectropolarimétriques obtenus pour les substances solubles dans l'eau sont plus élevées après irradiation, en particulier pour les longueurs d'ondes 302 et 312nm. Mais l'emploi de cette technique nécessitant la comparaison avec un échantillon témoin, cela en limite fortement l'intérêt.

Les lipides des crevettes irradiées ou non, fournissent des spectres IR identiques. Par contre le spectre infrarouge, des crevettes lyophilisées présente deux pics intéressants l'un à 3.40 et l'autre à 3.43 microns. Sous l'influence du rayonnement la bande à 3.43 microns fait place à un épaulement déjà à la dose de 100 Krad et celle à 3.40 microns est fortement affaiblie.

La mesure en infrarouge permet donc de faire la distinction entre crevettes irradiées et non irradiées, la limite semble se situer vers 100 Krad.

b) Cabillaud.

Les diverses façons d'appliquer l'infrarouge, ainsi que la spectropolarimétrie, n'ont pas révélé de différences entre

le poisson témoin et les échantillons irradiés jusqu'à une dose de 500 Krad.

c) Fraises.

On a étudié l'évolution des anthocyanes après 2 et 7 jours de conservation des fruits à + 2°C, et en fonction de la dose appliquée. La dose de 500 Krad exerce une action dépressive stable dans le temps. Par contre 100 et 200 Krad, affaiblissent la coloration non seulement immédiatement après le traitement, mais également au cours de la conservation.

Les résultats observés sont trop erratiques que pour servir de moyen de détection.

On a noté que l'action des rayons gamma sur l'activité PAL est sous la dépendance de la variété et des temps de conservation, mais en aucune façon ne permet de détecter l'irradiation.

d) Matières plastiques.

Le film de PVC faisant partie de l'emballage de cabillaud, ne révèle aucune différence par rapport au témoin, lorsqu'il a été irradié aux doses de 100, 200 et 500 Krad. Cela est valable pour l'examen en infrarouge normal, dans le proche infrarouge et en infrarouge différentiel. Cela fait supposer que l'aliment, qui est riche en eau, a neutralisé les effets du rayonnement sur le PVC. Car ce dernier lorsqu'il est irradié en feuille et à l'air, présente des modifications spectrales.

Par contre, la partie de l'emballage qui est en polystyrène, possède, lorsque la dose atteint 500 Krad, un spectre d'absorption différentiel important et très net caractérisé par 8 maxima.

Quant au polymère faisant partie de l'emballage des fraises, l'irradiation à 200 Krad se traduit par un glissement des pics observés dans le proche infrarouge, vers les longueurs d'ondes plus élevées.



TRANSPORT VON RADIONUKLIDEN IN DEN KOMPONENTEN DER UMWELT

TRANSFER OF RADIOACTIVE NUCLIDES IN THE CONSTITUENTS OF THE ENVIRONMENT

CHEMINEMENT ET TRANSFERT DES RADIONUCLIDES DANS LES COMPOSANTS DU MILIEU AMBIANT

Weitere Forschungsarbeiten zu diesem Thema werden auch in folgenden Jahresberichten beschrieben:

Further research work on these subjects will also be described in the following annual reports:

D'autres travaux sur ce thème de recherche sont également décrits dans les rapports annuels suivants:

100-BIAF CEA, CEN Fontenay-aux-Roses (Lafuma)
Biology Group Ispra

Contractant de la Commission :
Commissariat à l'Energie Atomique - Fontenay-aux-Roses,
France.

N° du contrat : 061-72-1

Chef du Groupe de Recherche : G. LACOURLY

Thème général du contrat : Niveaux de Pollution du
Milieu Ambiant -

L'objet du contrat consiste à rassembler et, éventuellement, élaborer les données et méthodes nécessaires pour évaluer, en tout point du territoire de la Communauté Européenne, et en fonction des paramètres qui déterminent les caractéristiques locales, les limites acceptables de la pollution radioactive du milieu ambiant et de la chaîne alimentaire.

Quatre projets principaux sont en cours :

- 1 - Etude des paramètres anatomo-physiologiques de l'homme européen nécessaires à l'évaluation des niveaux de protection et de leur variabilité au cours de la croissance.
- 2 - Etude des paramètres de la contamination de l'environnement à partir de la pollution de l'atmosphère.
- 3 - Etude des paramètres des transferts à l'homme de la contamination à partir de la pollution des eaux et au cours de la préparation des aliments de l'homme à partir des produits bruts.
- 4 - Etude des paramètres du comportement des métaux lourds (isotopes radioactifs et isotopes stables) : dans les sols et les sédiments.

Un cinquième projet est en préparation concernant l'étude des transferts des polluants dans les circuits de distribution des produits alimentaires.

Enfin, des études de synthèse concernant l'évaluation des conséquences des rejets radioactifs se poursuivent.

../..

General object of the contract : Pollution levels of the environment.

The purpose of this contract is to collect and incidentally to work out data and methods for assessing the permissible levels of radioactive contamination in environment and food chain, in every area of the Community, according to the parameters linked with local characteristics.

There are four principal projects running :

- 1 - Study of the anatomico-physiological parameters of European man required for assessing protection levels and their variability during growth.
- 2 - Study of the contamination parameters of environment linked with atmospheric pollution.
- 3 - Investigation of contamination transfers from water to man occurring during processing of raw produces into human foodstuffs.
- 4 - Study of the behaviour of heavy metals (radioactive and stable isotopes) in soils and sediments.

A fifth project concerning the transfer of pollutants through distribution channels of foodstuffs is being prepared.

Finally, synthetic studies concerning an assessment of the consequences of radioactive releases are carried on.

../..

Dr L. KARHAUSEN, Mme A. GARNIER

ETUDE DES PARAMETRES BIOLOGIQUES DE L'HOMME EUROPEEN -

RESULTATS

1. Thyroïde : enquête européenne -

Le premier programme portant sur la fonction thyroïdienne en Europe est terminé : il couvre environ 3 400 personnes en République Fédérale, 1 333 en Italie, 658 en France, 491 aux Pays-Bas et 171 en Belgique. Des variations importantes de la captation thyroïdienne ont été observées. La captation modale varie de 18 à 70%, mais la majorité des valeurs se situe entre 25 et 40% pour la plupart des villes étudiées en Italie et dans le Sud de la France. Elles vont de 45 à 69% en République Fédérale tandis qu'on observe des valeurs intermédiaires dans le Nord de la France et dans les pays du Bénélux. Les clearances thyroïdiennes varient de $2,2 \pm 0,2$ en Italie à $2,6 \pm 0,2$ en République Fédérale.

Ces valeurs sont beaucoup plus élevées que celles observées aux Etats-Unis. Parallèlement, les quantités d'iode ingérées sont très basses en Europe et très élevées aux USA. L'enquête se poursuit.

2. Thyroïde : Distribution de la dose aux tissus thyroïdiens -

La méthode générale de calcul mise au point par M. BOOZ vise à déterminer la dose délivrée aux différentes structures tissulaires de la thyroïde, principalement l'épithélium et le tissu intestinal, dans le cas d'ingestion d'iode 129, d'iode 131, d'iode 125 et d'iode 123.

La méthode repose sur trois paramètres :

a. La distribution de la dose dans toute la thyroïde autour d'un follicule contaminé.

a. La distribution de l'activité fixée dans le follicule.

c. Une expression mathématique qui résume les deux précédents. La répartition de la dose dans la thyroïde est ensuite obtenue par une méthode de Monte-Carlo qui reproduit la distribution des follicules dans la thyroïde.

.../..

Dans un premier temps, le cas le plus simple a été étudié, celui des électrons Auger de l'iode 125. Le calcul a été fait pour des follicules de 10 à 400 μm de diamètre avec une activité spécifique constante de 1 désintégration par seconde et μm^2 . On obtient ainsi des courbes de débit de dose en rad/s en fonction de la distance du centre du follicule.

Le travail se poursuit.

3. Absorption Intestinale du plomb -

La communication faite en 1972 sur l'absorption intestinale du plomb a fait l'objet d'une publication dans un volume de la Commission Européenne et de l'Agence de la Protection de l'Environnement des USA.

4. Absorption Intestinale du cadmium et du mercure -

Un travail a été présenté lors d'un symposium sur le Cd et le Hg dans l'environnement organisé par la Commission Européenne.

Les coefficients d'absorption de ces deux métaux et l'effet des paramètres qui les modifient ont été étudiés.

5. Modèle de transit gastro-intestinal -

L'étude de ce modèle est en cours à partir des données apportées par l'étude des paramètres de dilution chez le nouveau-né, l'enfant et l'adolescent.

Les résultats ont été regroupés de façon à permettre l'expression de l'évolution de la concentration du marqueur inerte en fonction du temps après l'ingestion du repas d'épreuve, en différents niveaux du tube digestif, chez les enfants de moins de deux ans, d'une part, et chez ceux de plus de deux ans, d'autre part. Cette expression est de la forme :

$$y = a_1 e^{b_1 t} \quad \text{pour } 0 \leq t \leq t_1 \text{ suivie de}$$
$$y = a_2 e^{b_2(t-t_1)} \quad \text{pour } t > t_1.$$

La concentration du marqueur en un point donné du tube digestif (défini par sa distance au nez) n'est pas constante, contrairement à l'hypothèse admise en première approximation pour l'établissement du modèle dans le cas de l'adulte.

L'expression de la dose d'irradiation interne au TGI, chez les enfants, sera donc établie sur ces nouvelles bases, pour chaque section du tube digestif, en fonction de la concentration initiale du radionucléide dans le repas (étude en cours).

../..

RESULTS

1. Thyroid : European survey -

The first part of our project on thyroid function in Europe has been completed.

It covers about 3,400 persons in West Germany, 1,333 in Italy, 658 in France, 491 in Holland and 171 in Belgium.

A broad range of thyroid uptakes have been observed. The modal uptake ranged between 18 and 70% after 24 hours. Most of the observed values lies between 25 and 40% for Italy and the South of France. They ranged between 45 and 69% in West Germany while the Benelux countries and the North of France showed intermediate values.

Mean thyroid clearances ranged from $2,2 \pm 0,2$ in Italy to $2,6 \pm 0,2$ in West Germany.

These values are much higher than those obtained in the USA and stable iodine intake is very high in the USA and very low in continental Europe.

2. Thyroid structure and dosimetry -

The comparing method used by Dr. Booz (Furatom, Ispra) will help to determine the radiation delivered to the histological structures in the case of ^{129}I , ^{131}I , ^{125}I and ^{123}I .

- a. The dose distribution in the thyroid, around an active follicle.
- b. The spatial distribution of the radioiodine within the follicle.
- c. A mathematical parameter which summarizes (a) and (b) .

The dose distribution within the thyroid is calculated through a Monte-Carlo method which provides a model of the spatial distribution of the follicle within the thyroid.

../..

The case of the Auger electrons of ^{125}I has been studied. The computation was made for follicles ranging in diameter from 10 to 400 μm with a constant specific activity of one disintegration/sec/ μm^2 . Curves have been obtained which represent dose rate (rad/sec) in relation to distance from the center of the follicle.

3. Intestinal absorption of lead -

A review of the literature on intestinal lead absorption was presented at a meeting and printed in a joint publication of EEC and EFA.

4. Intestinal absorption of cadmium and mercury -

A review of the literature on intestinal absorption of Cd and Hg was presented at Luxembourg during a conference organized by the EEC on the environmental aspects of Cd and Hg.

5. Mathematical model of gastro-intestinal physiology -

A research program has been completed on the progression and dilution of a non absorbable meal in the different segments of the digestive tract in infants, children and adolescents. We are trying to set up a model which could describe our data and which could be used for dosimetric purposes.

Contrary to the adult case, the concentration of the marker is not constant at a given level of the intestine. We hope to be able to calculate the internal radiation to the intestinal segments in infants and children as a function of the initial activity of the ingested meal.

PROJET N° 2

L. ANGELETTI -

ETUDE DES PARAMETRES DE LA CONTAMINATION DE L'ENVIRONNEMENT A PARTIR DE LA POLLUTION DE L'ATMOSPHERE -

RESULTATS

1. Etude du dépôt humide et de la rétention foliaire de l'iode et du strontium sur l'herbe -

En collaboration avec la Division de Biologie d'Euratom à Ispra, l'étude se propose d'évaluer la fraction d'un polluant entraîné de l'air au sol par la pluie, ou bien contenu dans les eaux d'irrigation, qui est retenue par les parties aériennes des différentes espèces végétales.

Cette étude qui est réalisée en laboratoire prend en considération cinq intensités d'aspersion échelonnées de 1 à 16 mm/h et deux radionucléides, le strontium et l'iode, les végétaux étudiés étant le ray-grass, le trèfle et des mélanges de ces deux espèces.

L'étude qui a commencé en 1973 sera complétée durant l'année 1974.

Les résultats obtenus jusqu'à présent et qu'on peut décrire actuellement seulement d'un point de vue qualitatif mettent en évidence la sensible différence existant entre le trèfle et le ray-grass, tant en ce qui concerne la rétention de l'eau que des radionucléides.

En fait, les valeurs relatives au trèfle sont bien supérieures à celles relatives au ray-grass.

En ce qui concerne la rétention des radionucléides, on observe pour le strontium des valeurs nettement plus élevées que celles de l'iode.

2. Etude du transfert de l'air au sol des gaz et des aérosols - (collaboration avec le KFA de JÜlich, RFA) -

Le programme de recherches en cours comprend les points suivants :

a. Etude de l'influence de l'ouverture des stomates sur la vitesse de dépôt de l'iode vapeur sur l'herbe.

- b. Etude de la désorption de l'iode vapeur et détermination de la période biologique de l'iode sur l'herbe.
- c. Etude du dépôt des aérosols sur des surfaces conventionnelles et sur la végétation (herbe, salades).

Les résultats de ces études ne sont pas encore disponibles.

STUDY OF ENVIRONMENTAL CONTAMINATION PARAMETERS FROM ATMOSPHERIC POLLUTION -

1 - Investigation of the wet deposition and the foliar retention of iodine and strontium on grass -

The purpose of this study, performed in collaboration with the Biology Division of Euratom, at Ispra, is to assess the pollutant fraction washed out by rain, from air to soil, or contained in irrigation water and retained by aerial parts of various plant species.

This laboratory investigation takes into account five asperion intensities, ranging from 1 to 16 mm/h and two radionuclides, strontium and iodine ; the plants studied are ray-grass, clover and a mixture of both species.

The study began in 1973 and will be completed during 1974.

The results obtained up to now can be described only from a qualitative point of view. They show the significant difference existing between clover and ray-grass in water retention as well as in radionuclide retention.

As a matter of fact, the values related to clover are appreciably higher than those concerning ray-grass.

Regarding the retention of radionuclides, the observed values are very higher for strontium than for iodine.

2 - Study of the transfer of gases and aerosols from air to soil (in cooperation with the " KFA Jülich " - West Germany) -

The research program in progress includes following points :

- a. Investigation of the influence of stomata opening on the deposition velocity of iodine vapour on grass.
- b. Study of iodine vapour desorption and determination of the biological period of iodine on grass.
- c. Study of aerosol deposition on conventional surfaces and plants (grass, salad).

The results of these studies are not yet available.

PROJET N° 3

R. BITTEL, Mme B. VAUBERT, Mme A. GARNIER.

ETUDE DES PARAMETRES DES TRANSFERTS A L'HOMME DE LA CONTAMINATION A PARTIR DE LA POLLUTION DES EAUX ET AU COURS DE LA PREPARATION DES ALIMENTS DE L'HOMME A PARTIR DES PRODUITS BRUTS -

RESULTATS

1. Etude de la contamination des végétaux irrigués (collaboration de la Division de Biologie d'Euratom à Ispra et du Laboratoire de Radioécologie Continentale du DPR à Cadarache) -

Les aspects suivants sont envisagés :

- Contamination des végétaux irrigués par submersion (Ispra) : Etude de la contamination de rizières et de riz en installations pilotes.

Les éléments étudiés sont le zinc 65 et le cadmium (traçage par ^{109}Cd). Les facteurs de transfert eau \rightarrow grains de riz sont déterminés (pour Zn ≈ 7 , pour Cd ≈ 100). L'étude doit être poursuivie par une recherche des paramètres de variabilité les plus importants.

- Contamination des végétaux irrigués par aspersion (Cadarache) -

On a étudié la contamination du maïs et du haricot, cultivés et irrigués en lysimètres dans des conditions voisines des conditions culturales normales. Le radionucléide envisagé a été ^{65}Zn . Les paramètres sont : l'état physico-chimique (Zn^{++} ou Zn-EDTA) et la qualité de l'eau. Les expérimentations viennent de s'achever. Les premiers résultats indiquent une absorption préférentielle du zinc ionique. L'incidence de la qualité de l'eau doit être précisée dans de brefs délais.

2. Etude de la contamination des organismes aquatiques -

- Contamination par les isotopes des métaux lourds ; organismes dulçaquicoles (en collaboration avec la Division de Biologie d'Euratom à Ispra et le Laboratoire de Radioécologie du DPR à Cadarache) -

Les études expérimentales relatives à la contamination de l'anguille par le cadmium ont juste débuté à Cadarache.

Les résultats obtenus à Ispra sur la contamination des poissons par le chrome 51 fournissent des données générales sur l'accumulation directe et intestinale de ce radionucléide par deux poissons dulçaquicoles. Les données sont en cours d'interprétation en vue d'en tirer des valeurs de facteurs de transfert.

- Contamination par les isotopes des métaux lourds ; organismes marins (en collaboration avec le CERBOH à Nice) -

On a étudié la chaîne eau-invertébrés (annélides), poissons benthiques, mammifères. Les éléments envisagés sont : Hg, Pb, Cr, Cu, Zn. Les recherches progressent normalement, et comme pour les études antérieures, les résultats seront interprétés en termes de facteurs de transfert, le paramètre étant l'état physico-chimique de l'élément.

- Transfert du tritium dans un écosystème naturel recevant des effluents radioactifs (collaboration avec le Département de Radiobiologie de l'ol) -

On a constaté que l'activité spécifique de l'hydrogène de l'eau de combustion de limons, de végétaux et d'animaux était en général très supérieure à celle de l'hydrogène de l'eau de ces étangs. Ces résultats, en désaccord avec ceux de mesures relatives à du tritium introduit sous forme d'eau tritiée méritent des expérimentations ultérieures.

3. Transferts des polluants au cours de la préparation des aliments de l'homme (collaboration avec le Laboratoire de Biologie Végétale du DRF-G du CEA) -

Les études relatives aux transferts des métaux lourds (Hg, Cd, Pb, Zn, Cu, ...) dans la chaîne aliments du bétail - lait - produits laitiers, menées avec le concours de l'INRA, sont achevées et en cours d'interprétation. Il apparaît que l'animal constitue un filtre efficace entre ses aliments et le lait. La fabrication des fromages provoque une reconcentration apparente des éléments si on se réfère à la matière fraîche, mais un tel phénomène ne se manifeste pas, si on rapporte les teneurs en métaux lourds à la matière sèche, ou bien aux teneurs en azote et en soufre des produits.

On vient de débiter une recherche sur les transferts du strontium, du césium et de divers métaux lourds, entre les matières premières entrant dans la fabrication de la bière (orge et malt, houblon, eau, levure) et la bière elle-même. Cette dernière action est menée avec le concours du Centre National de Brasserie-Maiterie de l'Université de Nancy.

.../..

INVESTIGATION OF TRANSFER PARAMETERS TO MAN OF WATER CONTAMINATION
AS RELATED TO HUMAN FOOD PREPARATION FROM RAW PRODUCTS -

RESULTS

1. Study of contamination of irrigated plants - (in collaboration with the Euratom Division of Biology, at Ispra and the CEA-DPr, Laboratory of Continental Radioecology, at Cadarache) -

The following aspects are considered :

- Contamination of plants irrigated by submersion (Ispra) :
Investigation of rice plantations and rice contamination in pilot plants. The element studied are zinc 65 and cadmium (using 109 Cd as a tracer). The transfer factors water --> rice seeds are defined. (for Zn \approx 7, for Cd \approx 100). The study will be carried on by the search for the most important variability parameters.
- Contamination of plants irrigated by aspersion (Carache) :
Contamination of maize and bean, cultivated and irrigated, under conditions, as close as possible to normal farming conditions, has been studied. The radionuclide considered was 65Zn. The parameters are : the physico-chemical state (Zn⁺⁺ or Zn EDTA) and water quality. Experimentation has just reached completion. The first results show preferential absorption of ionic zinc. The incidence of water quality has to be precised in the near future.

2. Investigation of aquatic organisms contamination -

- Contamination of freshwater organisms by heavy metal isotopes (in collaboration with the Biology Division of Euratom at Ispra and the Radioecological Laboratory of CEA (DPr) at Cadarache).

Experimental studies related to the contamination of eel by cadmium are just beginning at Cadarache.

The results obtained at Ispra on fish contamination by chromium 51 yield general data on direct intestinal accumulation of this radionuclide for two freshwater fishes. Interpretation of these data is in progress, with a view to deduce transfer factors.

../..

- Contamination of marine organisms by heavy metal isotopes (in cooperation with the " CERBOM " at Nice).

The purpose of this work was to study the chain water - Invertebrata (Annelida) by benthonic fishes, mammals. The elements considered are : Hg, Pb, Cr, Cu and Zn. Research is in progress. As for the former studies, results will be interpreted as transfer factors, the physico-chemical state of the element being the parameter .

Transfer of tritium in a natural ecosystem receiving radioactive wastes (collaboration with the Department of Radiobiology, at Mol, Belgium).

It has been established that the specific activity of hydrogen from water of limon calcination, of plants and animals, generally was very higher than the specific activity of hydrogen from the same pool water. So there is a discrepancy between these results and those from measurements concerning tritium introduced as tritiated water. Thus further experiments are needed.

3. Transfer of pollutants during preparation of human foods (in cooperation with the Laboratory for Plant Biology of "DRF-C CEA") -

The studies concerning transfers of heavy metals (Hg, Cd, Pb, Zn, Cu, ..) in live-stock foodchain, milk, dairy products, performed in cooperation with the " INRA ", have reached completion and interpretation of data is in progress.

Animals seem to be an efficient filter between their food and milk. Cheese making induces an apparent " reconcentration " of elements so far as fresh matter is concerned, but such a phenomenon does not occur if the heavy-metal content is related to dry matter or to the nitrogen and sulphur content of produces.

A research on the transfer of strontium, caesium and various heavy metals between raw produces of brewery (barley, malt, hops, water, yeast) and beer itself, has just been started.

This last work is performed with the assistance of the " Centre National de Brasserie-Malterie de l'Université de Nancy ".

../..

R. MAGNAVAL, R. BITTEL.

ETUDE DES PARAMETRES DU COMPORTEMENT DES METAUX LOURDS (isotopes radioactifs et isotopes stables) DANS LES SOLS ET LES SEDIMENTS -

1. Détermination du méthyl-mercure dans les sédiments par chromatographie (collaboration avec la section de Pathologie et Toxicologie Expérimentale, Département de Protection du CEA, Fontenay-aux-Roses)-

La méthode de détermination du méthyl-mercure par chromatographie en phase gazeuse avec un détecteur à capture d'électrons, déjà mise au point pour doser ce polluant dans la chaîne alimentaire (poissons, mollusques), est modifiée en vue d'une utilisation ultérieure sur des échantillons contenant 20 à 100 ppb de méthyl-mercure, tels les sédiments d'estuaire, soit des teneurs dix fois plus faibles que celles généralement mesurées dans les poissons.

L'appareil utilisé est un chromatographe en phase gazeuse Perkin-Elmer, modèle 900, à double colonne et à température programmée. La détection est effectuée par un capteur d'électrons ^{63}Ni .

De nouvelles phases stationnaires de polarités différentes ont été utilisées pour les analyses en faisant varier la température de la colonne, sa longueur, et le débit du gaz vecteur. Les résultats ainsi obtenus ont permis de sélectionner la phase stationnaire (HI-EFF-8BP) et les conditions analytiques les plus appropriées.

Dans le cas de sédiments inorganiques après la deuxième extraction benzénique, nous avons obtenu un rendement de l'ordre de 85%.

Dans le cas de sédiments organiques ou d'échantillons biologiques, une purification est nécessaire. Le rendement de la technique est, dans ce cas là, légèrement inférieur. Toutefois, les résultats sont reproductibles et permettent un dosage quantitatif dans la gamme 0,02 ppm - 0,5 ppm.

Cependant, la quantité retrouvée du chlorure de méthyle de mercure ajouté aux sédiments n'indique pas nécessairement que l'extraction du méthyle de mercure présent soit complète et la durée d'extraction par l'acide chlorhydrique doit être optimisée.

../..

L'emploi de la colonne 5% cyclohexanediméthanol-succinate sur chrom. W.H.F. a fourni une excellente séparation avec ces pics quantitatifs et sans traînée.

On détermine par ailleurs par la même méthode le mercure inorganique après l'avoir transformé en un dérivé organo-métallique tel que le chlorure de phényle de mercure, par l'action du benzsulfinate de sodium.

2. Transferts des polluants à partir du sol (collaboration avec la Division de Biologie d'Euratom à Ispra) -

Les points suivants ont été envisagés :

- comportement du chrome 51, introduit à l'état de chromate, dans des sols organiques acides : on constate une immobilisation intense et rapide,
- migration de l'iode dans le sol : des résultats complémentaires sont à attendre, notamment d'une collaboration entre différents services concernés, pour interpréter les données expérimentales dans le cas de pollution par l'iode 129.

INVESTIGATION OF THE BEHAVIOUR PARAMETERS OF HEAVY METALS/RADIOACTIVE AND STABLE ISOTOPES) IN SOILS AND SEDIMENTS -

1. Chromatographic determination of methyl-mercury in sediments (in collaboration with the section of experimental Pathology and Toxicology, "DPr, CEA" at Fontenay-aux-Roses) -

The determination method of methyl-mercury by gas chromatography with an electron capture detector, already developed to determine this pollutant in the foodchain (fishes and Mollusca) was modified for a further use on samples containing 20 to 100 ppb methyl-mercury, such as estuary sediments, that is to say, ten times lower contents than those generally measured in fish.

The apparatus used is a gaseous phase radiochromatograph PERKIN-ELMER, design 900, with double column and programmed temperature. Detection is performed by an ^{63}Ni electron catcher.

New stationary gaseous phases with various polarities have been used for analysis by varying the temperature of the column, the length and the flux of the vector gas. The results obtained, in this way, allowed a selection of the stationary phase (HI-EFF-8 BP) and the most appropriate analytical condition.

Concerning inorganic sediments, the efficiency obtained in benzene extraction is about 85%.

Organic sediments or biological samples however need purification. In this case, efficiency is slightly lower.

Results are nevertheless reproducible and allow an quantitative analysis ranging from 0,02 ppm to 0,5 ppm.

However, the quantity of mercuric methylchloride found that was added to the sediments does not necessary show that the whole amount of methyl-mercury present has been extracted. Thus the duration of the extraction by hydrochloric acid has to be optimized.

Using the column 5% cyclohexanedimethanol succinate on chromium W.H.P. provides an excellent separation, showing quantitative peaks without trail.

The same method is used for determining inorganic mercury that has been changed into an organo-metallic derivative, such as mercuric phenyl chloride obtained through sodium benzo sulfinate.

2. Transfers of pollutants from soil (in collaboration with the Division Euratom of Biology at Ispra) -

The following subjects have been planned :

- behaviour of chromium 51, introduced as chromite in acid organic soils : quickly, an intense immobilization takes place,
- iodine migration in soil : Experimental data concerning pollution by iodine 129 will be interpreted with the help of further results provided by the different laboratories involved in this work.

EUR 4964 (f Fs)

KARHAUSEN L., PACES J.P., VACCA G., PIEPZ A. et DEVISSCHER M.
Métabolisme de l'iode chez l'enfant et l'adolescent dans une région
de la Communauté.

KARHAUSEN L.

Dosimétrie thyroïdienne et distribution de radioiode au sein du
tissu thyroïdien (rapport interne)

EUR 4872 f

ANGELETTI L.

La contamination des pâturages par l'iode ¹³¹I - 1ère partie :
vitesse de dépôt de l'iode ¹³¹I.

EUR 5 000 f FS

MAGIAVAL R.

Pollution des végétaux par le sol : le cas du césium ¹³⁷Cs.

EUR (sous presse)

Rapport annuel 1972.

BITTEL R.

Etude bibliographique du comportement des métaux lourds en milieu
marin, en vue de l'évaluation de la capacité limite d'acceptation
des écosystèmes océaniques pour la pollution chimique.
Revue Internationale d'Océanographie Médicale, vol XXX, pp 3-37, 1973.

BITTEL R.

Projet : Etude du transfert des isotopes des éléments métalliques,
des produits bruts récoltés aux produits alimentaires au stade de
la consommation par l'homme - cas de la bière.

GARRIER A., LACOUPLY G.

Considérations relatives à la prévision sur une base régionale
des conséquences radiologiques des rejets normaux d'installations
nucléaires.

BITTEL P.

Incidence des paramètres physico-chimiques sur la contamination
radioactive des écosystèmes irrigués.
AIEA, Aix-en-Provence, 14-18 Mai 1973.

LACOURLY G.

La protection de l'homme et de son environnement contre les risques
résultant du développement de l'énergie nucléaire - Situation
actuelle - Perspectives futures.
A.I.M. Liège, 22-25/1/1973.

LACHET B., MAGNAVAL R.

Equation empirique traduisant l'épuration des eaux de surface.

(AIEA, Aix-en-Provence, 14-18/5/1973).

BRUANT C., BRUANT J.P., NEUBURGER M., VASSAL L., FOURCY A., BITTEL R.

Détermination du cadmium et du mercure dans des aliments du bétail, le lait et des produits laitiers - Premiers résultats -

Communautés Européennes, Luxembourg, 3-5 Juillet 1973.

KARHAUSEN L.

L'absorption intestinale du cadmium et du mercure

Communautés Européennes, Luxembourg, 3-5 Juillet 1973 .

BATTI R., MAGNAVAL R., LAMY G., LAFUMA J.

Détermination de faibles teneurs de mercure organique et inorganique par chromatographie en phase gazeuse

Communautés Européennes, Luxembourg, 3-5 Juillet 1973.

BRUANT C., BRUANT J.P., NEUBURGER M., VASSAL L., DISANT C., BITTEL R., FOURCY A.

Etude de quelques métaux lourds dans la chaîne herbe-produits laitiers au moyen de l'activation neutronique et de l'absorption atomique.

(AIEA, Helsinki, 27-31 Août 1973).

KIRCHMANN R., BITTEL R., FAGNIART E., VAN GELDER-BONNIJNS G., KOCH G.
Transfer of tritium for radioactive waste to aquatic organisms under natural conditions.

Louvain, ESNA, 11-14 Septembre 1973.

LAUMOND F., NEUBURGER M., DONNIER B., FOURCY A., BITTEL R., AUBERT M.

Experimental Investigations at laboratory, on the transfer of mercury in marine trophic chains.

(Etude expérimentale au laboratoire du transfert du mercure dans deux chaînes trophodynamiques marines).

(ESNA, Louvain, septembre 1973).

AUBERT M., BITTEL R., LAUMOND F., ROMEO M., DONNIER B., SARELLI M.

Utilisation d'une chaîne trophodynamique de type néritique à mollusques pour l'étude des transferts des polluants métalliques

Colloque International d'Océanographie Médicale, Porto-Poz, Yougoslavie, 26-30 Septembre 1973.

VAN DER BORCHT O., BITTEL R., VAN PUYNBROECK S., COLARD J.

Long term laboratory experiments on the fixation of various ruthenium-106 compounds by freshwater organisms.

(AIEA, Varsovie, 5-9 Novembre 1973).

HEINEMANN K., VOGT K.J., ANGELETTI L.

Dépôt et rétention sur l'herbe de l'iode élémentaire et d'iodure de méthyle

(AIEA, Vienne, Novembre 1973).

..../..

ERMANS A.I.

Etablissement d'un modèle mathématique du cycle de l'iode chez l'homme et chez l'enfant - Rapport final - 2ème partie : Etude morphologique (rapport interne).

LOEB

Etude des modifications de concentration d'une substance non absorbée - Le polyéthylène glycol (PEG) dans le tube digestif de l'enfant normal (rapport interne).

VOGT K.J., HEINEMANN K., MATTHES W., POLSTER G., STOEPLER (KFA)

Jod auf Gras (juillet 1971 - décembre 1972).

KIRCHMANN R. (Mol)

Transfert du tritium dans les chaînes trophodynamiques aquatiques irriguées.
(rapport provisoire, février 1973) (rapport interne).

KIRCHMANN R., FAGNIART E., BONNIJNS G., VAN GELDER E., and BOSSUS A.

Transfert du tritium dans les chaînes trophodynamiques aquatiques et irriguées.
Rapport final 1973 (rapport interne).

AUBERT M., BARELLI M., BITTEL R., DONNIER B., LAUMOND F., ROMEO M.

Recherches sur les facteurs de transfert de polluants métalliques dans les chaînes trophodynamiques marines (CERBOM), 1972-1973 (rapport interne).

d° , rapport partiel au 1/5/1973 (rapport interne).

BRUANT-SAUGY C.

Etude de quelques éléments d'intérêt écologique dans la chaîne herbe-produits laitiers (rapport d'activité 1972) (rapport interne).

VAN DER BOGHT C., VAN PUYMEROECK S., COLAR J.

Fixation biologique à long terme du ¹⁰⁶Ru.
(CEN-MOL) (rapport interne).

AUBERT M., BITTEL R., LAUMOND F., ROMEO M., DONNIER B., BARELLI M.

Utilisation d'une chaîne trophodynamique de type pélagique pour l'étude des transferts des pollutions métalliques.
(in : Revue Intern. d'Océanographie Médicale, XXVIII, 1972, 27-52).

../..

VOGT K.J., GEISS H., NORDSIECK H., POLSTER G., RCHLOFF F.,
Untersuchungen zur Ausbreitung von Abluffahnen in der Atmosphäre
Ausbreitung von Schadstoffen in der Atmosphäre und Umweltbelastung,
KFA.

COMPOSITION DU COMITE DE GESTION

Dr JAMNET	Président
Dr RECHT	Vice-Président
G. BRESSON	Secrétaire
MM LAFFAYE)
DE SADELEER) Membres
VAN HOECK)

Contract No. 104-73-1 BIAI

Laboratorio per lo Studio della Contaminazione Radioattiva del Mare
Association CNEN-EURATOM - Fiascherino (La Spezia) Italy

Dr. Michael Bernhard

Title:

The dynamics of radioactive and stable elements in the marine environment
under special consideration of those elements which are important to marine
radiocontamination

As in previous years the projects of the association have been organised according to the different levels of the food chain. Physical and chemical environmental factors, first trophic levels (phytoplankton), first heterotrophic levels (zooplankton and bacteria), last heterotrophic levels (crustaceans and fish). One project represents the joint effort of all projects, it synthesizes the results obtained and uses the information obtained from own experiments and literature to build models concerning the kinetics of radioisotopes and stable elements in laboratory experiments and in natural ecosystems. As in the past, each project consists of two parts, one to be carried out under laboratory conditions and one in the field in order to guarantee that the results obtained in the laboratory are comparable to those observed in nature.

For the greater part of 1973, the laboratory vessel "Odalisca" was not available because it had to be reclassified and therefore the several aspects of the field programs could not be carried out.

Project No 1

Title: Physical environmental factors of marine contamination and
Special Developments

Name of scientists: M. Bernhard and F. Möller (part time)

Results:

Development of an instrument computer system for the determination of number and size of fluorescent and not fluorescent particles

A new electrical circuit for the cell counter based on the Coulter counter principle has been constructed and tested. A fluorescent particle counter similar to the one used by Dr. B. Sengbusch of the Battelle Institute, Frankfurt employing a normal fluorescence microscope with different types of illumination was constructed in our laboratory and the illumination and laminary flow system was tested with different size algae.

Simulation and model building

As contribution to project 7 the data of up-take and loss of radioactive and stable phosphorous by Phaeodactylum tricornutum were utilised to build a two-compartment model of a growing phytoplankton culture. Different biological parameters were estimated from the raw data and various simulations were compared with the experimental results and the values of the parameters adjusted to obtain an optimal fit of the data to the simulation. In order to evaluate the influence of compartment size on the transport rates, different rates of changes of the compartment sizes were simulated in 2 and 3 compartmental systems.

A three compartmental system in steady state published by Cornover and Francis was simulated on our computer and their technique was compared with ours. Our techniques of analysing the data resulted as faster and simpler while at the same time applicable to both steady and non-steady state models. The symbolisms used

by Cornover and Francis were transcribed into the symbolism suggested by the ICRU.

Similarly papers published by Pentreath and collaborators were analysed and classified as steady and non-steady-state models and transcribed into the above mentioned symbolism. In the process of transcription special emphasis was placed on identifying boundary conditions which were not explicitly mentioned by the authors.

The experiences gained, together with a literature search on the use of compartmental models in marine radioactivity, were used to prepare a working paper "Use of Compartmental Models in Radioecological Laboratory Studies", M. Bernhard, A. Bruschi and F. Möller for the IAEA Panel on the Design of Biological Experiments in Marine Radioecology.

3) Instrumentation and Apparatus needed by other groups

- The 'Bottle-with-ground-glass-stopper' sample changer has been supplied with a new and more versable electrical circuit.
- The hardware for the IBM edition system has been completed and the software program has progressed to the stage that the written text is numerated and can be brought to a desired length by either shortening or lengthening of the line.
- For the Fisheries group a system for the thermostatisation of aquaria at three different temperatures and a sand filter for the continuous sea water system have been readied.

4) Collaborations with project 3

In collaboration with the Botany Group two other working papers for the above mentioned IAEA Panel were prepared: "Phytoplankton experiments with radiotracers" by A. Zattera, M. Bernhard and C. Galli and "Benthic algae experiments with radiotracers" by M. Bernhard and A. Zattera. These two papers deal with the handling of benthic algae and phytoplankton in experiments with radiotracers and

with the analysis of parameters influencing uptake and loss. Furthermore a review paper "Toxic substances in the marine environment", M. Bernhard and A. Zattera, has been presented at the 2nd International Symposium on Marine Disposal (Sanremo 17-21 December 1973).

Project No 2

Title: Investigation of the chemical factors influencing the distribution
of the most important elements in the marine environment

Name of scientist: A. Piro

Results:

1) Automated colorimetric method for direct iron determination in sea water

Some modifications of the automated colorimetric method for the determination of iron in sea water have been carried out. Iron, in fact, has been found partially present in sea water in a very stable (probably complexed) form, from which could not be quantitatively separated by the mineralization process normally used. During the sample storage (under acidic conditions in order to avoid adsorption on the surface of the container) this stable form is slowly hydrolysed, transforming iron in an easily reacting form. This results in an apparent increase of the iron concentration during storage. In order to measure all the iron present in a sea water sample, the mineralization conditions have been successfully modified. The increase in temperature and pressure up to 145°C and 4.0-4.5 atm. respectively was found effective in getting all the bonded iron in the ionic oxidized state. The method is now ready for the routine applications.

2) Automated colorimetric method for direct zinc determination in sea water

The development of the automated method for the colorimetric determination of zinc in sea water has been continued. Comparison between the total polarographic and colorimetric measurements are carried out. The values obtained by colorimetry seem to be 20 % higher than the polarographic ones and investigations are planned in order to explain this difference.

Large interferences have been found by heavy metals especially iron, and experiments to overcome this problem are carried out. The copper interference, on the contrary, has been eliminated by addition of bisulfate in the reaction manifold.

Project No 3

Title: The role of phytoplankton in the accumulation, loss and transfer of radioisotopes in the marine environment

Name of scientists: A. Zattera and L. Rampi (part time)

Results:

1) Uptake of stable and radioactive zinc

Algae are fast growing organisms and thus increase the pH of the culture medium during growth. For this purpose uptake of Zn^{65} at different pH's have been evaluated.

At the end of the logarithmic growth phase the pH of the culture can sometimes reach high values (per instance 8.7 to 9) if not corrected. This fact can influence the physical-chemical state of zinc and hence influence its uptake.

Experiments have been conducted to see if the zinc taken up at the pH of the culture is lost if the pH is lowered. At pH 8.7 the uptake was 45 % of the total Zn^{65} present in the culture medium. Lowering at the end of the growth phase the pH to that of natural sea water (~ 8.1) the zinc taken up by the algae does not change significantly. On the contrary, if the pH is lowered to pH 6 only 25 % of the total zinc in the medium is associated with the algae. The difference $45-25 = 20$ % may be due to zinc adsorbed onto the algae and/or to inorganic particles present in the medium as has been shown previously by the chemical group.

Experiments to study the relation between surface of algae and zinc adsorption have been made.

2) Uptake of phosphorous

Uptake experiments of stable and radioactive phosphorous in relation to light energy supplied have been made in order to evaluate the fluxes or transport rates adapting a two-compartment-closed system (in collaboration with project 7). With changing light energy supplied transport rates change.

3) Uptake of caesium

First experiments on the uptake of caesium have been carried out. The uptake of Cs^{134} by Phaeodactylum tricornutum is proportional to the growth of population and reaches a plateau when the population stops growing. Concentration factors estimated at the plateau vary from 5 to 8.

4) Studies on phytoplankton populations

Further in situ experiments have been conducted in order to compare the behaviour of natural and artificial (algae strains from the laboratory culture collection) populations. The results show that a selection occurs between species of the natural population and that the generation time and the growth coefficient of species composing the natural populations do not change significantly from those of single similar species.

Since the prediction of radiocontamination should be made at species level, as has been suggested by nutrition studies with organisms of higher trophic levels, the correct identification of a species should have the same accuracy as enumeration of populations. For the above purposes the construction of a key for the identification of phytoplankton has been continued. A first draft of a key for the identification of Coccolithophoridae has been set up.

Project No 4

Title: The role of the first heterotrophic levels (zooplankton) in the accumulation and transfer of radionuclides relevant to marine radiocontamination

Name of scientist: A. Nassogne

Results:

The project has been temporarily discontinued, because Dr. Nassogne left the laboratory.

Project No 5

Title: The role of the last levels of the food chain (mussels, crustacea, fish) in the accumulation and transfer of radionuclides relevant to marine radiocontamination

Name of scientist: E. Schulte

Results:

1) Field experiments with mussels (*Mytilus edulis*)

The growth of 2000 specimens of *Mytilus edulis* under natural conditions in six different localities of the La Spezia Gulf as well as under constant conditions in the laboratory was studied. Every month the three size groups of mussels (15, 45, 60 mm in length) were measured (length, width, height) as well as all environmental factors possibly influencing the growth (temperature, salinity, pH-value, food-concentration, oxygen content). All field data are evaluated by means of a computer program.

2) Rearing and culturing experiments

Crustacea: *Leander squilla*

Over three months the moulting frequencies of newly hatched larvae and their growth (total length and carapace length of the moults) were measured in two different experiments using single specimens in 50 ml sea water at a temperature of 20°C. It could be shown that there are quite great differences between single specimens concerning the moulting frequencies as well as intervals between two subsequent moults namely, with increasing number of moults, the spreading of the time for a certain moult increases.

Increasing temperatures (5°, 10°, 15°, 20°, 25°, 30°C) directly influenced the survival, growth rates, and duration of developmental stages of Leander squilla larvae.

In a series of experiments using different culture volumes (1000, 2000, 5000 ml sea water) with constant surfaces the influence of space and population density on the duration of larval stages and the developmental velocity of Leander squilla was studied. The duration of the larval stages III, IV, VA, VB is shortened with increasing culture volume, while the beginning or maxima of all larval stages are shifted towards earlier days with increasing culture volumes. After 30 days of hatching the percentage of post larval stage increases with increasing volume, while the percentage of stage VA and VB is diminished. A bigger culture volume resulted in a faster growth increment.

- Size at first spawning of Leander squilla

The smallest size at which females, hatched under laboratory conditions, have external eggs has been found to be 13 mm, which will thus probably be approximately the minimum size for fully mature females under laboratory conditions. The size of males of the same age was 11 mm, while under natural conditions females at time of first spawning will be 29 mm and males 24 mm in size.

- Fish species

Benthic as well as pelagic fish species (Atherina boyeri, Mullus barbatus, Mugil capito, Diplodus annularis, Trachurus mediterraneus) are successfully tried to keep in the laboratory under constant conditions in aquaria with sand filter systems. They are fed with prefabricated and natural food (mixture of fish flesh and crustacean muscle).

The growth increments of each fish will be measured weekly for evaluation of the energy conversion ratios.

Project No 6

Title: The role of heterotrophic level of microorganisms in the uptake and transfer of a few ecologically relevant radionuclides and distribution of metabolically active bacteria in the marine environment.

Name of scientist: C.N. Peroni

The work about the transfer of ^{32}P to copepods via labelled bacteria has been continued.

The activity taken up by the copepod E. acutifrons was tenfold greater when alive β_2 algal cells were present in comparison with the blanks (copepods incubated in the presence of labelled bacteria without algae). When algae were UV-inactivated, the activity taken up by copepods was twice as much as the blank.

Preliminary experiment on ^{65}Zn uptake by bacterial strain λ was performed. It seems that no detectable uptake occurs probably because the Zn content of bacterial cells is too low in comparison to the radioactive zinc added.

Preliminary experiments on ATP detection by liquid scintillation were begun.

The optimum conditions are under investigation in order to set up a method by which bacterial concentration in SW samples can be determined.

A linear response to the increase of ATP concentration was observed. The question is now to improve the sensitivity in order to detect small amounts of bacterial cells.

Project No. 7

Title: Simulation of laboratory experiments and model building of natural and artificial systems.

Name of scientists: Joint participation of the other groups

Results:

1) Multi compartment systems

As contribution to this project the Special Developments Group has enlarged the computer program for 2 and 3 compartments to accommodate compartmental systems not in steady state up to 10 compartments. The program is written for the Laben 70 computer in 'Basic'. The 'Basic' has been changed by us so that the data can now also be stored and retrieved from magnetic tape.

The modelling of laboratory experiments with the previously written programs are described under project 1 and 3.

2) Survey of a future disposal site (Gulf of Tarant)

The survey has been further postponed and will start again in 1974.

Publications prepared during the year 1973

- Bernhard, M. and A. Zattera, 1973 - Toxic substances in the marine environment.
To be published in the proceeding of the International Symposium "Inquinamento marino e scarichi a mare".
- Möller, F. and A. Zattera, 1973 - The application of sequential estimation methods to count of phytoplankton.
To be published as an internal technical report.
- Bernhard, M. and A. Zattera, 1973 - Phytoplankton in relation to experiments with radiotracers.
To be published in "Reference methods for marine Radiobiological Studies".
- Möller, F., 1973 - Sistemi di scompartimento trattati come processi stocastici.
Giornale di Fisica Sanitaria e Protezione contro le Radiazioni.
- Peroni, C., and O. Lavarello, 1973 - La distribuzione dei batteri pelagici nel Mar Ligure.
Giornale di Fisica Sanitaria e Protezione contro le Radiazioni.
- Piro, A., M. Branica, M. Bernhard and A. Piro, 1973 - Zinc in seawater II.
To be published in "Marine Chemistry".
- Zattera, A., M. Bernhard and C. Galli, 1973 - Benthic algae in relation to experiments with radiotracers.
To be published in "Reference methods for Marine Radiobiological Studies".

Management Committee

President: Prof. B. SCHREIBER

Members: Prof. P. KORRINGA, Drs. F. van HOECK and O. SIGNORINI

Secretary: Dr. L. FORTI

Collaborations and participation in scientific meetings

As in the past the laboratory has collaborated with the Istituto di Zoologia (Prof. B. Schreiber), Parma, the International Laboratory for Marine Radioactivity (IAEA) Principality of Monaco and the Center of Marine Research (Institute Ruđer Boskovic) Rovinj Yugoslavia and the Laboratory, Plymouth.

The 16th Contact Group Meeting on Marine Radioactivity was held at Fiascherino, May 9 - 11, 1973. At this meeting participated besides staff members of the above mentioned laboratories, scientists from Fisheries Radiobiological Laboratory, Lowestoft, England and the Radiobiological Laboratory of the Biologische Anstalt Helgoland, Hamburg, Germany.

Contractant van de Commissie: Institute of the Association EURATOM-ITAL, Wageningen, the Netherlands.

Nummer van het contract: 094/72/1 BIAN

Hoofd van de groepen voor onderzoek: Dr. Ir. D. de Zeeuw.

Algemeen onderwerp van het contract:

RADIATION PROTECTION

- Movement of radioactive pollutants in soils.
 - Uptake of radioactive pollutants by plants.
 - Radiation effects (physical, genetical, physiological)
-

Algemene omschrijving van de uitgevoerde werkzaamheden:

Main topics of the 1973-research by the soils and plant group of the Institute were:

- sampling and analysis for control of the mathematical simulation model concerning the behaviour of ^{90}Sr and ^{137}Cs in soils of Western Europe.
- transport and behaviour of ^{51}Cr , stable chromium, zinc, mercury and mercury compounds in soils. Working out of a mathematical simulation model concerning the behaviour of mercury in an ecosystem.
- kinetics of the uptake and subsequent behaviour of ^{51}Cr , stable chromium and cadmium in intact plants and in isolated chloroplasts.

The work on heavy metals in soils and plants is part of a research programme on "heavy metals in the food chain and in the biosphere", in collaboration with the Biology Division at Ispra-CCR (Italy) and with other Institutes in the Countries of the European Community.

Research topics on radiation effects in 1973 were:

- further control and extension of a molecular theory on radiation effects in biological material, by analysis of literature data and by experimental verification.
- development of improved dosimeters and their application in biological research.

The programme for 1973 has once more been carried out in close cooperation with other scientific institutes and organizations. Examples of this scientific collaboration are:

- on different aspects of the application programme within workinggroups of the European Society of Nuclear methods in Agriculture (ESNA);
- on pollution, radioactive and other, with the Biology Division in Ispra and institutes in the Netherlands, Belgium and Germany;
- on radiation effects within the European Dosimetry working group;
- on standardization of absorbed dose and dose distribution measurements within the European Late Effects Project Group (EULEP);
- on mutation breeding (vegetatively propagated crops, incompatibility, protein improvement, disease resistance) in higher plants in the Mutation Breeding Contact Group;
- on incompatibility in higher plants with several institutes and organizations within the European Community;
- cooperation to projects concerning the testing of irradiated food, wholesomeness testing set up by the Organization for Economic Cooperation and Development (OECD) and the International Atomic Energy Agency (IAEA). In this respect also collaboration exists with institutes in the Netherlands, Denmark, Belgium;
- research on genetic control of insect pests, coordinated in Section VII of the TNO working group "Integrated control of Insect Pests and in the joint European Working Group of the "Organisation Internationale de la lutte Biologique (OILB). Cooperation within projects of the IAEA and of the entomology programme of the Biology Division.

INSTITUTE OF THE ASSOCIATION EURATOM-ITAL

P.B. 48, Wageningen, The Netherlands.

Board of Governors

J.A.P. Franke	chairman
J.B. Ritzema van Ikema	vice-chairman
G. Wansink	secretary
T.J. Barendregt	
H.N. Hasselo	
A.C. Schuffelen	

Management Committee

G. Wansink	chairman
R. Craps	
F. van Hoeck	
J.B. Ritzema van Ikema	
A.C. Schuffelen	

International Scientific Advisory Council

A.C. Schuffelen	chairman
T.J. Barendregt	
H. Laudelout	
H. Laven	
H.F. Linskens	
H. Marschner	
G.T. Scarascia Mugnozza	
G.F. Wilmink	

Changes in the Scientific Staff

New members of the scientific staff are:

Dr. A.S. Robinson from Great Britain, dr.ir. A.F. Groneman, ir. S. Roest, drs. J.A. van Veen and dr. P.A.Th.J. Werry, all from The Netherlands.

- Temporary members (post-graduate fellows) responsible for particular aspects of the programme: Ir. Miss H.M.G. Groot, Miss M. Matteoli, Ir. C. Petit and Ir. J.P. Rolland.
- Several guest-workers have spent 6 to 12 months at the Institute.

Resultaten van het project No. 3

Hoofd van het team en wetenschappelijke medewerkers:

M.J. Frissel en P. Poelstra.

Titel van het project: Transport of chromium and other heavy metals (Hg excluded) in soils.

Beschrijving van de resultaten:

Transport and accumulation of zinc in soils

Within the frame of the joint project with the Forschungsanstalt für Landwirtschaft (FAL) at Braunschweig (FRG) zinc migration studies have been set up on undisturbed soil columns taken from the Braunschweig sewage fields. These migration studies were carried out under the same conditions as the chromium migration studies, but under aerobic conditions only and with 1 ppm Zn in the leaching solution. Moreover, undisturbed soil columns were taken from an untreated field close to the sewage field for comparison. Zn-65 labelled Zn Cl₂ was added on top of each column; the migration was followed by the soil column scanner. The results are presented in fig. 3. It appears that zinc does move under these conditions and about 1.4 times faster in the sewage treated field than in the untreated field. A preliminary simulation model was developed for the behaviour of zinc under the operating conditions by two students from the Agricultural University at Wageningen (J.M.C. Dirven and K. van Staveren. Simulation of zinc migration in a sandy soil). Experimental data, like adsorption isotherms at different depths of the columns, the content of zinc as function of depth etc., were used in the model. A comparison between the results of the experiments and the calculations showed that the movement of zinc in the treated soil was about twice as fast as predicted by the simulation model. More research is needed to explain this difference.

Transport and accumulation of chromium in soils

1. Also in cooperation with the FAL chromium migration studies were set up on undisturbed soil columns taken from the sewage field. These migration studies are carried out under aerobic and under anaerobic conditions, with a flux of 24 mm per 24 hours, using a solution of 0.0244 M (Ca, Na, K)Cl in a ratio of 3:1:1 with 1 ppm Cr of the Cr-compound studied. The top layer of the soil in the column is mixed with the radioactive Cr compound (using Cr-51, $t_{1/2} = 27,8$ days) before the experiment is started. Cr-compounds investigated are CrO₄²⁻ at pH = 8 under aerobic conditions

and Cr^{3+} at pH = 5 under anaerobic conditions. During the experiment the redox potential is measured in the centre of the column at a depth of 15 cm.

From fig. 1 it can be seen that movement of the chromium compounds did not occur, neither under aerobic nor under anaerobic conditions. The redox potential gradually changed in the aerobic system from - 40 mV about + 720 mV and in the anaerobic system from - 40 mV to about - 160 mV and remained rather constant afterwards.

2. A chromium monitoring programme has been set up on the same soils as used for the mercury monitoring programme. Part of the results are available, they are presented in fig. 2, where the chromium distribution over the profile is shown as a function of depth. Two soils are foreland soils from the river Rhine - Valburg and Biesbos resp., the third one - Alkmaar - is a reference soil, used as a permanent pasture for over 20 years. In the reference soil - containing 50 ppm Cr in the top soil - some chromium may be introduced by fertilizer dressing (phosphates, which may contain Cr up to 500 ppm) which is gradually distributed over the top soil by biological mixing. The foreland soils show a much higher Cr content, Valburg 150 ppm in the top soil and the Biesbos even 450 ppm in the top soil. The difference in chromium content in the 3 sub soils is probably caused by differences in chromium content of the parent material. The distribution pattern over the profiles of the sampling sites suggests that migration of chromium does not occur in soils.

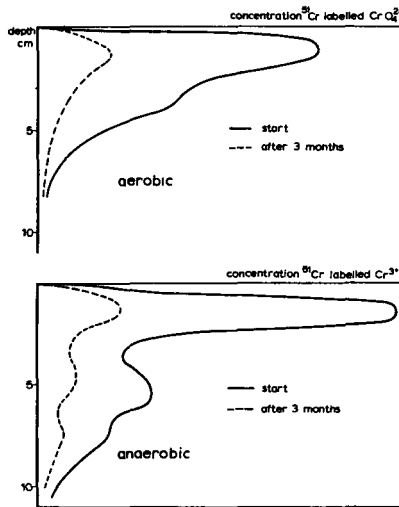

fig. 1. Results of leaching experiments in a column with Cr-51 labelled K_2CrO_4 and CrCl_3 resp. Reduction in concentration after the experimental period is due to the fast decay of Cr-51 ($t_{1/2} = 27.8$ days)

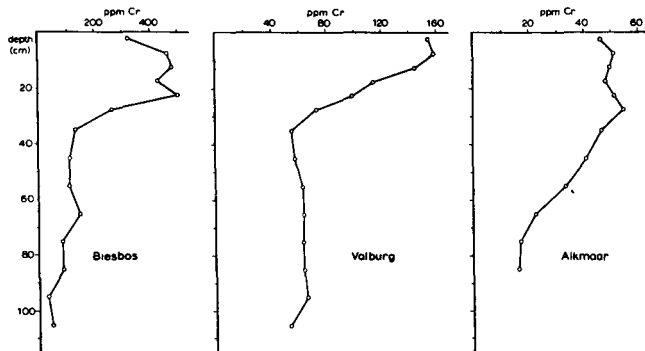

fig. 2: Chromium distribution as a function of depth.

Publications-1973

DIRVEN, J.M.C. and K. VAN STAVEREN

Simulation of zinc migration in a sandy soil.

Internal report no. 143 Association Euratom-ITAL, October 1973.

FRISSEL, M.J. and P. POELSTRA

Behaviour of Cr and Zn in soil.

POELSTRA, P. and M.J. FRISSEL

Report on experiments with chromium

Contribution on the meeting: heavy metals in the food chain and in the biosphere. Ispra, December 1973.

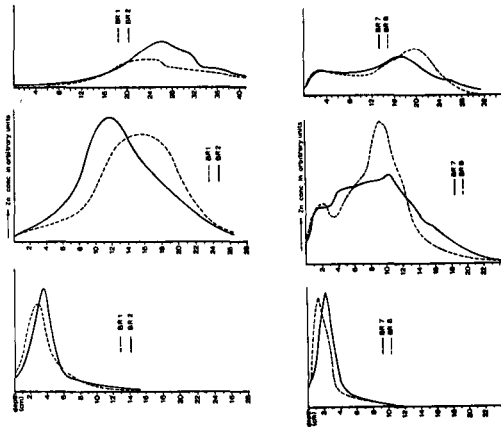

fig. 3. Results of leaching experiments in columns with Zn-65 labelled $ZnCl_2$ in a sewage treated field (columns Br 1 and Br 2) and in an untreated field (columns Br 7 and Br 8). The results are recorded 10, 77 and 151 days resp. after the beginning of the experiment.

Resultaten van het project No. 4

Hoofd van het team en wetenschappelijke medewerkers:

M.J. Frissel en P. Poelstra

Titel van het project: Behaviour of mercury and mercury compounds
in soils

Beschrijving van de resultaten:

1. The mercury monitoring programme, in 1972 restricted to the Netherlands, has been extended to soils situated in Germany (FRG), France and Italy. Location of the sites see fig. 1; description of the soils and mercury contents see table 1. Mercury profiles see fig. 2.

The soils sampled can be divided into 3 groups:

The first group 1 to 10 are reference soils. No mercury has been introduced into these soils. No profile disturbances occurred during the last 20 years.

The mercury content in the top 20 cm of these soils ranged from 0.02 ppm to 0.10 ppm, and averaged 0.07 ppm. The distribution over the profiles reveals that the mercury content diminishes with depth rather quickly and below 20 cm is never more than 0.04 ppm. The "distribution over Europe" suggests that the mercury content is higher in regions with high industrial activity e.g. sampling sites nos. 1, 2 and 3 in the Netherlands and no. 10 in Italy. So the figures suggest the existence of mercury fallout originating from man's activities.

The second group consists of 2 soils from the bulb-growing area in Holland (11 and 12). The application of mercury as a fungicide in these areas has been common practice for 50 years. The soils had a mercury content of about 0.15 ppm in the top 20 cm layer and a distribution pattern over the profile different from those of the reference soils (Fig. 2). It is obvious that mercury accumulation does occur in these soils, when compared with the reference soils. This accumulation, however, is not excessive (For further explanation see publications).

The third group of soils are foreland soils from the River Rhine. The Rhine is heavily polluted. These soils are frequently flooded, usually in winter. The soils sampled in these areas showed mercury contents of over 10 ppm. Obviously the mercury stems from the River Rhine and is strongly adsorbed by clay.

In cooperation with the waterworks company of the city of Amsterdam, soil samples have been taken up to a depth of 150 cm from infiltration canals in dunes where Rhine water is purified to drinking water. It appeared that mercury accumulates in the top soil of the infiltration canals. The two sampling sites showed a mercury content of 0.16 ppm and 0.33 ppm in the 0 - 20 cm layer, resp. whereas a non irrigated dune showed a content of 0.03 ppm in the same layer. The sludge also holds back a considerable amount of mercury, it shows mercury contents up to 1 ppm.

2. Migration experiments have been carried out under controlled conditions with γ -emitting mercury compounds in columns with undisturbed soil profiles. These columns are 100 cm long with an inner diameter of 12 cm, provided with rain heads and automatic control units for maintaining a proper supply of the influent in small droplets with fluxes to be varied from 0.6 mm to 180 mm per day. A soil column scanner records the distribution pattern of the compound under investigation. The top 5-cm layer of the soil is then homogeneously labelled with ^{203}Hg labelled mercury chloride, monomethyl mercury chloride or metallic mercury resp. The column was scanned to determine the distribution of the label before the beginning of the leaching. Leaching was performed with a flux of 24 mm per 24 hours with an artificial soil solution (0.003 N CaCl_2 , 0.001 N KCl , and 0.001 N NaCl). Air was sucked continuously over the top of each column to remove volatile compounds which might escape from the soil. These compounds were trapped. The columns were scanned monthly. Four columns were used for each mercury compound. Two of the four columns were leached continuously, the other two periodically, usually 16 hours a week, keeping the net flux equal for all columns. The temperature was kept at 20°C. From the results it can be concluded that migration of metallic mercury and HgCl_2 does not occur, CH_3HgCl was leached downwards a little between the moment that the compound was added to the soil and the first measurement, thereafter the migration was almost negligible. Evaporation was slow for all the compounds, whether they were leached continuously or periodically. Within the frame of a joint project with the Forschungsanstalt für Landwirtschaft at Braunschweig (FRG), mercury migration studies have also been carried out on soil columns, taken from the sewage fields of Braunschweig. Leaching solution 0.0244 M (Ca, Na, K) Cl in a ratio of 3:1:1, flux 24 mm per 24 hours, leaching period 3 months. The top layer of the soil in the column is mixed with Hg-203 labelled HgCl_2 before starting the experiment. The whole system is kept anaerobic. No movement of the mercury could be observed.

The column experiments and the field measurements indicate a strong adsorption of mercury and its compounds in the top layer of soil. Leaching is hardly involved. Evaporation does occur to some extent, but the evaporation rate is very low.

3. Applying a modified computer simulation programme for the behaviour of mercury in the ecosystem (from Anderson and Anderson (1972)), it could be calculated that the amount of mercury present in the reference soils could not be explained by global mercury fallout only.

A regional multiplication factor had to be introduced. For Bari this factor amounted about 1, for Ahrweiler and Amiens about 5 and for the soils near Alkmaar, Hilversum and Amersfoort as well as for the soils near Hannover and Ispra about 10. This indicates that the contribution of man-made mercury is higher in regions with high population density and high industrial activity.

So the high mercury levels in soils can be explained by accepting local fallout due to man's activities (See publications symposium Helsinki, 1972).

4. The methylation of mercury compounds or their conversion into volatile products has been considered via a thoroughly executed literature search. This literature search, recorded in a report (W. Tap, Methylation of mercury) together with results from experiments made by Van de Steene, has shown that methylation of mercury compounds or their conversion into volatile compounds is of little significance for soil systems, that the reverse reaction-demethylation-diminishes the effects and that conversion rates are not quantitatively known.

Publications - 1973

POELSTRA, P., M.J. FRISSEL, N. VAN DER KLUGT and D.W. BANNINK
Accumulation and distribution of mercury in Dutch soils.
Neth. J. agr. Science 21, 77-84 (1973).

POELSTRA, P., M.J. FRISSEL, N. VAN DER KLUGT and W. TAP
Behaviour of mercury compounds in soils: accumulation and
evaporation.

Symposium on comparative aspects of food and environmental
accumulation (FAO/IAEA/WHO), Helsinki. Sept. 1973.

FRISSEL, M.J., P. POELSTRA and N. VAN DER KLUGT.
The contamination of dutch soils with mercury and a few other
heavy metals.
Geologie en Mijnbouw (in press)

Contribution to the monograph: simulation of accumulation and
leaching in soils. Edited by M.J. FRISSEL and P. REINIGER.

TAP, W.
Methylation of mercury
Euratom-ITAL November 1973.

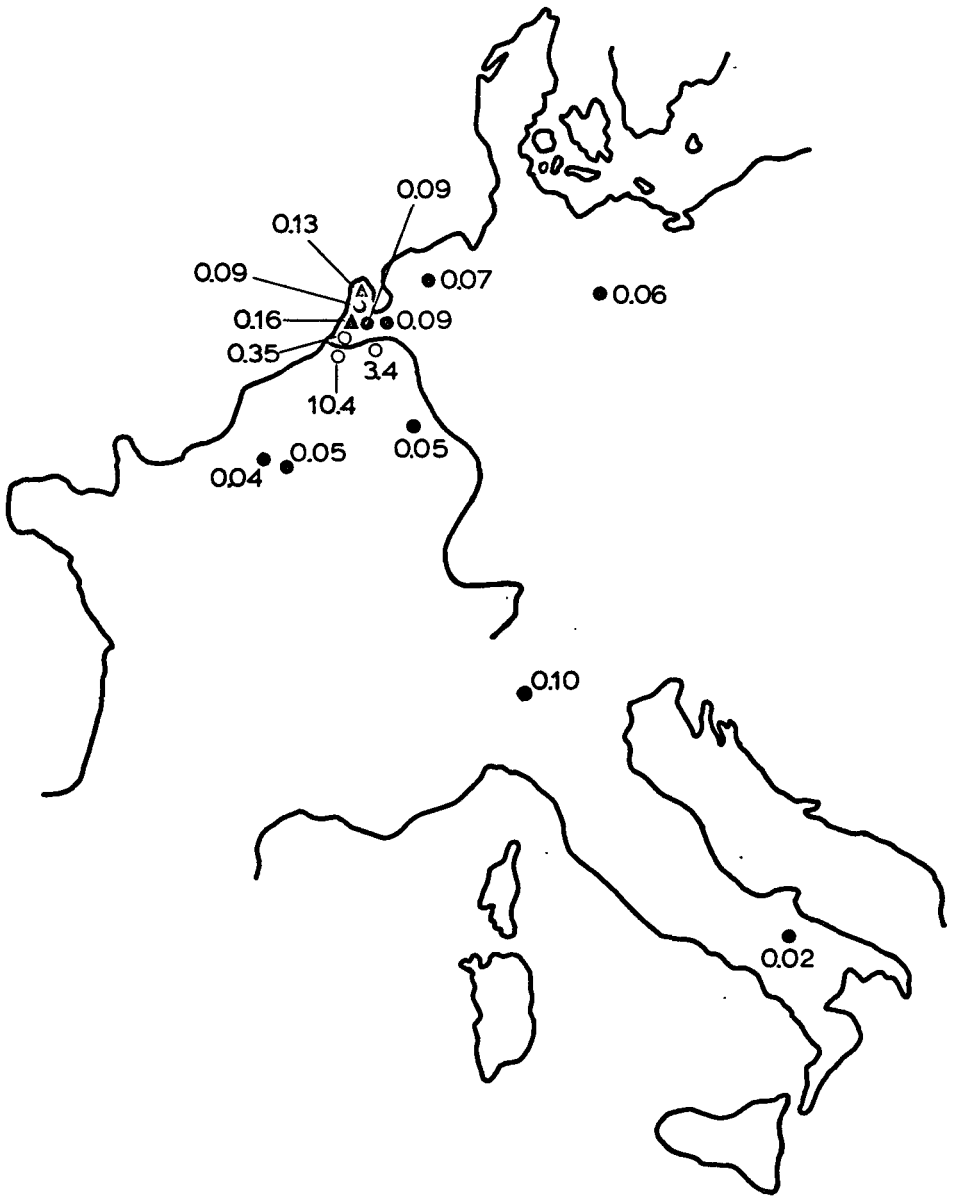

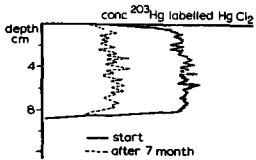
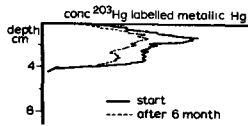
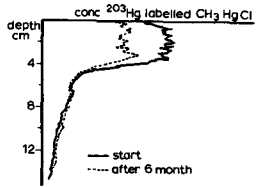
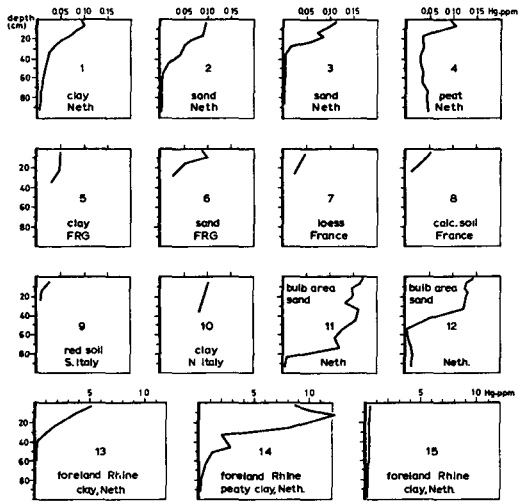

Legends of figures

fig. 1.- Location of sampling site. Mercury content in
0 - 20 cm layer of soils in ppm.

- Pastures
- ▲ Soils bulb-growing area
- Foreland soils River Rhine

fig. 2. Mercury distributions as function of depth.

fig. 3. Results of leaching experiments in a column with Hg-203
labelled HgCl_2 , metallig Hg and CH_3HgCl resp.
Reduction in concentration after the experimental
period is due to the fast decay of Hg-203 ($t_{1/2} = 47$ days).

Hoofd van het team en wetenschappelijke medewerkers: G. Verfaillie
 Titel van het project: Kinetics of uptake of heavy metal-ions
 by intact plants.

Beschrijving van de resultaten:

Started in 1972 with the kinetics of chromium uptake by intact rice plants (Oryza sativa L.cv. arborio) from nutrient solution containing K_2CrO_4 and Cr^{III} -EDTA, the study has been continued in 1973 with the kinetics of chromium uptake from solutions contaminated with Cr^{+++} ions. Using the same methods as before, the range of Cr^{+++} concentrations has been extended from $10^{-7}M$ Cr^{+++} up to $10^{-4}M$ Cr^{+++} .

The results obtained in this study are:

1. The extraction of chromium from a chromic solution occurs in 3 successive steps as it can be seen in fig. 1 and fig. 2.
 - A short phase of physical absorption at high velocity lasts for about 6 minutes.
 - A phase of chemical absorption on preexisting fixation sites or of chemical reaction with a pool of metabolites has a velocity decreasing parabolically during 8 to 10 hours (2d order interaction).
 - The last phase is continuous and corresponds to a real metabolic uptake proceeding at a low and slowly decreasing rate (1st order).

This phase requires the continuous creation of new fixation sites and the continuous delivery of suitable metabolites by the leaves. Indeed, this 3d phase disappears when the aerial parts are removed, whereas the other phases do not, and even might be simulated by the exchange of new $^{51}Cr^{+++}$ injected without notable carrier amount (fig.3).

2. The metabolic phase shows 2 isotherms both corresponding to saturation kinetics. Expressing the results with hyperbolic functions similar to those used by Michaelis (fig. 4) and Hofstee (fig.5), the following kinetic parameters have been calculated, the threshold concentration being $T = 1.72 \times 10^{-5}M$ Cr^{+++} : (gFR = gram fresh root)

Parameters	Below threshold	Above threshold
V_m	0.52 nMol/h.gFR	3.4 nMol/h.gFR
K_m	$5.14 \times 10^{-6}M$	$2.65 \times 10^{-5}M$
$F_m = (V/C)_m$	0.1 ml/h.gFR	0.14 ml/h.gFR

3. The distribution of the chromium after absorption is identical to that found for the chromate form, the most part remaining fixed on and in the roots (95 to 98 percent).
4. No physiological effect could be observed on the plants. It must, however be emphasized that the threshold concentrations found by us for both chemical forms correspond exactly to the toxicity levels found by our colleague C. Myttenaere at Ispra, Italy for long term contamination by the chromium compounds.
5. Making a synthese of all results we have got in 1972 and 1973, we can say that, as far as the aerial parts of the plants are concerned in the food chain, the plant mineral nutrition cannot be considered as a vector of the pollution by the chromium, whatever the chemical form of the latter is, either because of the extremely low rate of its absorption by the roots ($\text{Cr}^{\text{III}}\text{-EDTA}$) or because of the very weak translocation of the element to the aerial parts (Cr^{+++} and HCrO_4^-). Compared kinetic functions are also given in table 1.

Full details of the techniques, of the methods and of the results will be found in the proceedings of the symposium held in Otaniemi, Finland, (see publication list). Compared results on the same subject obtained at the Biology Division of the European Communities at Ispra in Italy as well at the EURATOM-ITAL Association Institute will be presented in a monography to be published in 1974.

Table I

Kinetic functions compared for chromium and phosphate.

(W = transpiration rate)

Elements	Cr (maximum values)			P (10^{-3} M)
	$\text{Cr}^{\text{III}}\text{-EDTA}$	K_2CrO_4	$\text{Cr}(\text{NO}_3)_3$	KH_2PO_4
V nMol/h.gFR	0.35	34.2	4.0	440
F = V/C ml/h.gFR	0.018	4.8	0.1	0.44
D = F/W unities	0.082	8.2	0.5	1.2

Publications-1973

VERFAILLIE, G.R.M.: The kinetics of chromium absorption by intact rice plants (*Oryza sativa* L. cv Arborio). FAO/IAEA/WHO Symposium on Nuclear Techniques in Comparative Studies of Food and Environmental Contamination, Otaniemi, Finland, 27-31 Aug. 1973 (Proceedings in press).

VERFAILLIE, G.R.M.: The kinetics of chromium absorption by intact rice plants (*Oryza sativa* L. cv Arborio). IV annual ESNA Meeting, Louvain, Belgium, 11-14 Sept. 1973.

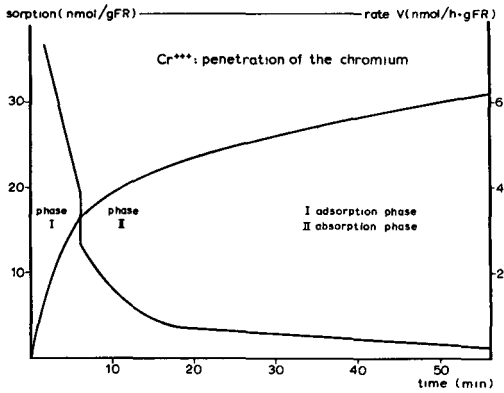

fig. 1. The sorption of the Cr⁺⁺⁺ ions : phase 1 and phase 2.

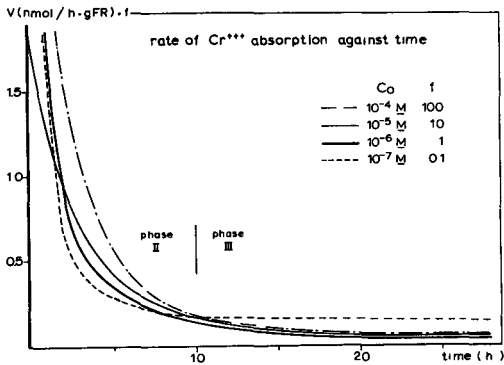

fig. 2. The sorption of the Cr⁺⁺⁺ ions : phase 2 and phase 3.

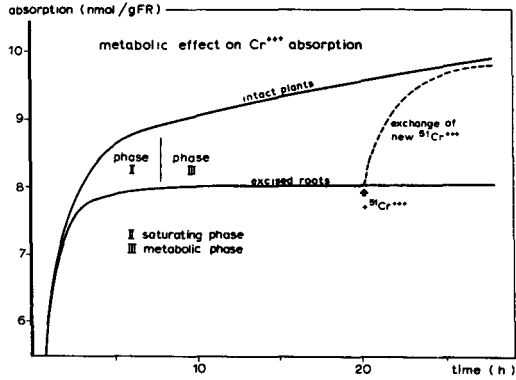

fig. 3. The metabolic effect on the Cr^{+++} - absorption.

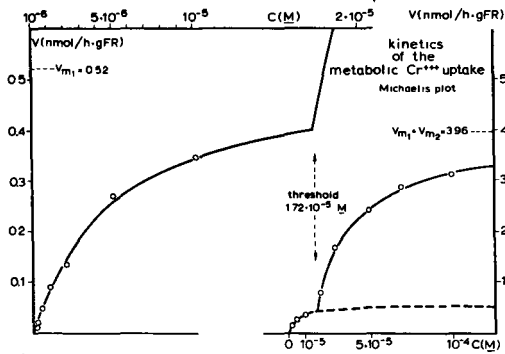

fig. 4. Kinetics of the metabolic Cr^{+++} - uptake : Michaelis plot.

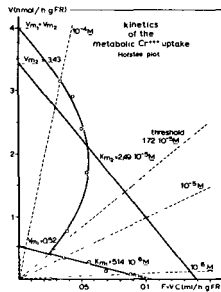

fig. 5. Kinetics of the metabolic Cr^{+++} - uptake : Hofstee Plot.

Resultaten van het project No. 6

Hoofd van het team en wetenschappelijke medewerkers:

C.Petit and G.Verfaillie

Titel van het project: Transport, accumulation, redistribution
of heavy metals in intact plants.

Beschrijving van de resultaten:

The results which are available for the moment were obtained with Cadmium and the Tomato plant, Lycopersicum esculentum, L. (Mill), cv. Marette. Our attention was mainly drawn by the accumulation of that heavy metal in the plants being grown in a polluted substrate as well as by the movement of Cadmium inside the stem.

1. Growing in polluted substrate.

Ten days old seedlings are put on Hoagland solution which contains, expressed in mM: 6K, 5 Ca, 2 Mg, 15 NO_3 , 2.01 SO_4 , 1 H_2PO_4 , 0.0091 Mn, 0.00076 Zn, 0.00031 Cu, 0.082 Fe(EDTA), 0.082 Na. To this solution, weekly replaced, we add Cd^{++} of which the concentrations, expressed in mM, are the following: 0., 0.00324, 0.01621, 0.03241, 0.08104. The plants are harvested after 6 weeks, dried, weighed and the Cadmium content is determined by atomic absorption spectrometry.

We came to the following observations.

Both decreasing yield and symptoms of toxicity begin to appear from 16,21 mM: yellowing of the leaves, longer internodes, delay or lack of lateral buds as well as of the flowering. At the highest concentration, the plants are living without developing however.

The greatest deal of Cadmium is accumulated in the roots while the transport index - $\frac{\text{Cd aerial part}}{\text{Cd total}}$ - decreases with increasing pollution (fig.1).

The pH variations in the various solutions were measured during the last week. The plants alcalinise their substrate at a smaller rate when the Cadmium concentration increases.

The EDTA, used in the nutrient solutions in order to maintain a sufficient level of iron, also results in the chelation of all micronutrients. Being interested in the divalent ionic form, Cd^{++} , we have three possibilities to avoid, at the same time, deficiency in iron and Cadmium complexation.

-Iron is supplied by foliar aspersion. In this respect, a test has been conducted, but without succes.

-Iron can be maintained in the nutrient solution by using EDDHA- éthylène diamine di(o-hydroxyphénil acetic acid) - which chelates iron more specifically than EDTA. The knowledge of the formation constants of the various metallic EDDHA chelates (H, Fe, Ca, Mg, Cu, Zn, Cd) allows the determination of the percentage of chelated Cadmium in equilibrium with a solid phase of ferric hydroxide. From a theoretical study it results that the complexation of Cadmium is still relatively too sensitive to the variation of EDDHA concentration. This variation depends on the initial Zn and Cu level which is itself modified in the process of uptake by plants. However, by refreshing continuously the solution, all variation can be eliminated.

-Iron is still present in the nutrient solution when no chelating agent is used, because it is in equilibrium with the solid phase of $\text{Fe}(\text{OH})_3$. By maintaining a low pH (so as to obtain a maximum concentration of Fe^{+++}) and by constant refreshing of the solution one may hope to avoid the deficiency of iron and to keep the concentration of all the elements constant.

The pKs of $\text{Fe}(\text{OH})_3$ being 37, the concentration of Fe^{+++} is equal to 10^{-10} M at pH 5. As appears from figure 2, A and B, no significant coprecipitation with $\text{Fe}(\text{OH})_3$ occurs in a Hoagland solution containing $5 \cdot 10^{-7} \text{ M Cd}(\text{NO}_3)_2$ at pH 5 while adding $10 \cdot 10^{-6} \text{ M Fe}(\text{NO}_3)_3$.

2. Movement of Cadmium in the stem.

Using a semiconductor detector assembly (see previous reports), it has been possible to observe the accumulation and the redistribution of Cadmium in the stem, when it is traced with $\text{Cd}^{115\text{m}}$ ($E_{\text{max}} = 1,63 \text{ Mev}$). Cd can be detected, above the cotyledons of a three weeks old plant, 30 min. after the roots have been dipped in an Hoagland solution containing $6 \cdot 10^{-6} \text{ M Cd}(\text{NO}_3)_2$ and 0.1 mCi per liter.

When the radioactive solution is replaced either by demineralised water or by an aqueous solution of $10^{-5} \text{ M Cd}(\text{NO}_3)_2$ the rate of local accumulation of $\text{Cd}^{115 \text{ m}}$ decreases gradually toward zéro. However, if the washing solution is a cadmium free Hoagland solution or a pure $13 \cdot 10^{-3} \text{ M Ca}(\text{NO}_3)_2$ solution,

then the accumulation rate vanishes, approximately after two hours and becomes negative.

Cadmium could be linked to some sites in the vessels of the stem from which it can be moved by other ions, at least by Calcium. In collaboration with project No 30 the computing of the energy spectra of Cd^{115m} , recorded during these experiments, is being carried out for the moment. It will give more information about the lateral movement of cadmium inside the stem.

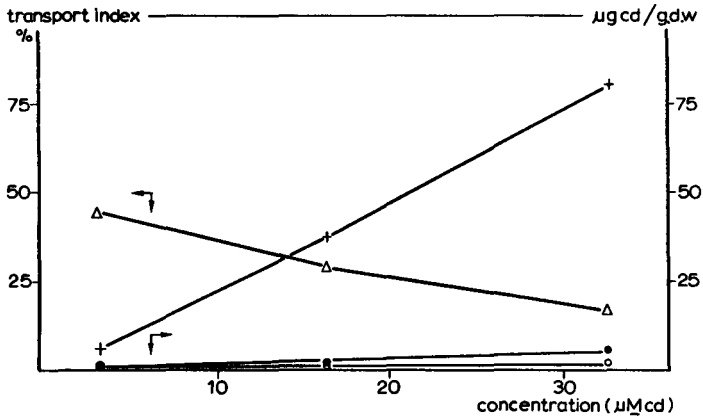

fig. 1. Transport index of Cadmium, Δ , and Cadmium content of the roots, +, of the leaves, o, of the stem, o, in relation to various Cadmium concentrations in the nutrient solution.

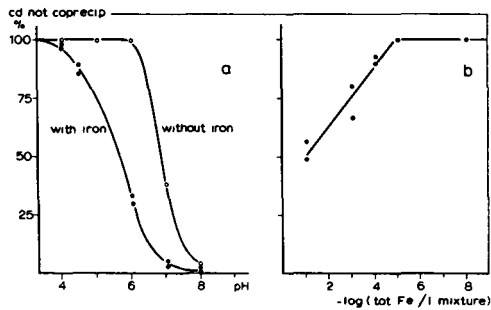

fig. 2 A Effect of the pH on the coprecipitation of Cadmium. Chelate-free Hoagland solution without iron or after adding 10^{-3} Mol $\text{Fe}(\text{NO}_3)_3 \cdot 9\text{H}_2\text{O}$ per liter, Cd concentration: $5 \cdot 10^{-7}$ M.

2 B Effect of various addition of $\text{Fe}(\text{NO}_3)_3 \cdot 9\text{H}_2\text{O}$ on the coprecipitation of Cadmium. Chelate-free Hoagland solution at pH 5. Cd concentration: $5 \cdot 10^{-7}$ M.

Resultaten van het project No. 7

Hoofd van het team en wetenschappelijke medewerkers:

G. Desmet, M. Matteoli, A. de Ruyter.

Titel van het project: Uptake and release of heavy metals by
subcellular structures, mainly chloro-
plasts and mitochondria.

Beschrijving van de resultaten:

The project is subdivided in two parts since work has been done on two heavy metals: Chromium and Cadmium.

A. Chromium.

The uptake and metabolism of chromate by chloroplasts isolated from spinach leaves (Spinacea oleracea L, cv. Amsterdams Reuzeblad) has been studied at pH 7.6. Work at pH's below 7 is without physiological sense, in work with chloroplasts.

Therefore also no Cr^{3+} has been investigated, since it precipitates at a high pH.

The uptake of CrO_4^{2-} is measured by a combination of centrifugation and visible light spectrophotometry, using the extinction spectrum around 372 nm. From the decrease of extinction of chromate in the supernatant an uptake saturation of about 40 ng CrO_4^{2-} per μg chlorophyll is observed. The question whether chromate is transformed during its absorption by the chloroplasts was tackled by the comparison of the spectra of chromate, absorbed by the chloroplasts, with the ones of chromate free in solution. A decrease of the extinction of the absorbed chromate has been found.

Therefore it could be partly transformed by the chloroplasts, maybe from Cr(VI) to Cr(III). This transformation is compared to the real uptake in fig. 1. Because the molecular extinction coefficient of Cr(III) at its maxima is very small compared to the one of CrO_4^{2-} , no Cr(III) spectrum was measurable.

The standard redox potential E'_0 of $\text{CrO}_4^{2-}/\text{Cr}^{3+}$ in alkaline medium is about -0.13 V. Light activated chloroplasts are known to generate a redox power of at least - 0.42 V. It was thus worthwhile to look after a possible reduction of CrO_4^{2-} by illuminated chloroplasts. Measurements of the influence of chromate on the variable fluorescence and on the O_2 evolution of activated chloroplasts has been performed. From these experiments it became evident that chromate really can act as an electron acceptor in a photosynthetic electron transport chain.

The active concentration however depends on the presence of a concurrent electron acceptor e.g. NADP^+ or methylviologen; fig.2, CrO_4^{2-} has been mentioned to be an antagonist of SO_4^{2-} reduction. Preceding its reduction SO_4^{2-} must be energized by ATP. CrO_4^{2-} need not for even in the absence of ATP formation, due to the presence of an uncoupler $\text{CH}_3\text{NH}_3\text{Cl}$, chromate reduction can occur, fig. 2.

B. Cadmium.

In this research two important topics are concerned. First, the physicochemical behaviour of the element Cd towards different ligands, and secondly the influence of the Cd^{2+} on the metabolism of active chloroplasts. Due to the complexity of the chloroplasts medium, the ligand properties of every substance belonging to this buffer solution has been investigated. This work has been done by means of a Cd^{2+} sensitive electrode system. The medium contains 0.25 M saccharose, 0.01 M MgCl_2 , 0.035 M KCl, 0.05 M TES at pH 7.6. In this medium Cd^{2+} is complexed to the amount of 70 %. A detailed investigation showed Cl^- and TES to be responsible for this complexation (fig. 3).

From the study about the influence of Cd^{2+} on the O_2 evolution of chloroplasts it became clear that Cd^{2+} inhibits the electron transport (fig. 4 a). Besides it interacts with the energy metabolism of the chloroplasts. Indeed in the absence of a pretreatment with the uncoupler $\text{CH}_3\text{NH}_3\text{Cl}$ an increase of the electro transport rate is observed at the lowest Cd^{2+} concentrations. Finally of course at the higher concentrations the inhibitory action dominates (fig. 4 b). A detailed study on the precise interaction site of Cd^{2+} with the electron transport chain is performed. From this it has been found out that Cd^{2+} , though it is at high active concentrations, is a rather specific inhibitor. It does not destroy the chloroplasts since most of the electron transport reactions remain intact. Cd^{2+} appears to interact with the H_2O splitting enzyme of photosynthesis, and with the energy metabolism.

Publications - 1973

DESMET, G., A. DE RUYTER, A. RINGOET. Uptake and metabolism of CrO_4^{2-} by isolated chloroplasts, to be presented at "the Workshop on membrane transport in Plants and Plant Organelles" Jülich 4-8 February

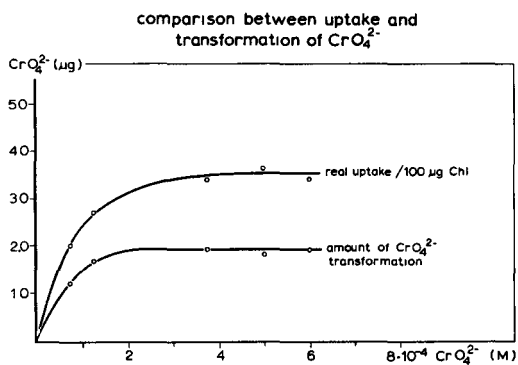

fig. 1. Comparison between uptake and transformation of CrO_4^{2-} by isolated chloroplasts.

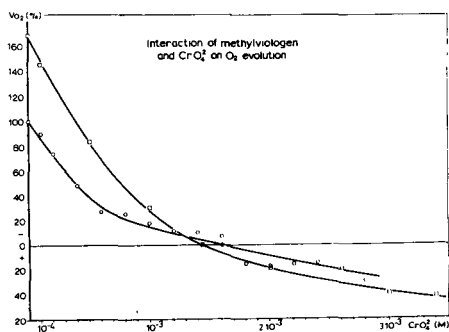

fig. 2. Interaction of methylviologen and CrO_4^{2-} on O_2 evolution.
 \square — \square in the absence of an uncoupler
 \circ — \circ in the presence of an uncoupler ($\text{CH}_3\text{NH}_3\text{Cl}$)

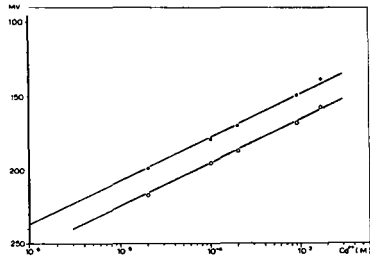

fig. 3. Influence of the chloroplast medium on ligand complexation of Cd⁺⁺.

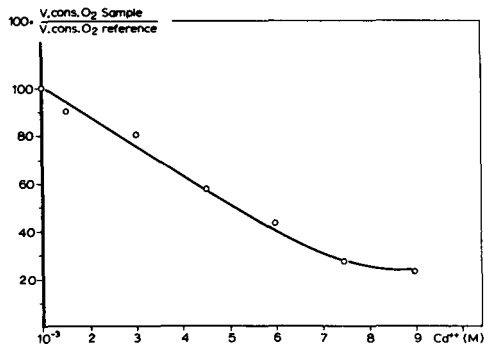

fig. 4a. Influence of Cadmium on the photosynthesis rate of uncoupled chloroplasts.

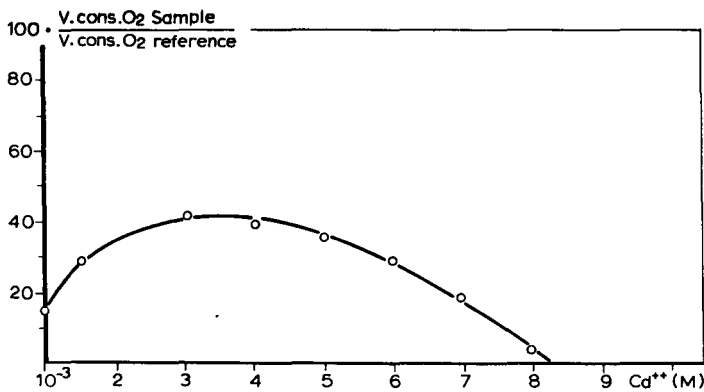

fig. 4b. Influence of Cadmium on the photosynthesis rate of coupled chloroplasts.

Resultaten van het project No. 8

Hoofd van het team en wetenschappelijke medewerkers:

K.H. Chadwick, H.P. Leenhouts, K.J. Puite, W.F. Oosterheert.

Titel van het project: Primary radiation effects in inert and biological material.

Beschrijving van de resultaten:

The molecular theory

Certain consequences arising from the proposals of the molecular theory have been checked.

Chromosome aberrations and cell death

If $N = \alpha D + \beta D^2$ is the number of DNA double strand breaks induced by a dose D and these breaks can lead to cell death and chromosome aberrations then cell survival, $S = e^{-p(\alpha D + \beta D^2)}$ and yield of chromosome aberrations, $Y = k(\alpha D + \beta D^2)$ and a direct correlation between survival and chromosome aberrations should exist, namely

$$\ln S = -\frac{p}{k} Y.$$

This correlation has been found, using the data of Dewey et al. (Rad.Res. 41, 1971) to be statistically highly significant and independent of cell phase and the presence or absence of a radiosensitizer.

Intercentromeric dicentric length and fragment length

If the proposal that a single break in a chromosome backbone, a DNA double strand break, is sufficient to lead to an aberration then in order to explain the formation of a dicentric it is necessary to assume that rejoining is possible between a broken and normal chromosome end. This means that the intercentromeric dicentric length cannot be less than the length of one chromosome arm (Fig.1) and that a restricted relationship exists between the dicentric length and the fragment. This relationship is different than that which would be found on the basis of the classical or exchange hypotheses. This relationship has been investigated using *Tradescantia paludosa* irradiated with 300 rad of X-rays. The dicentric-fragment relationship, expected from the molecular

and classical or exchange hypotheses, was determined using unirradiated mitoses. Figure 2 shows the results of the measurements of dicentrics and fragments. The results fall into the area defined by the molecular hypothesis although the classical or exchange hypotheses are not mutually excluded.

(work carried out by A. Spanjers on a 6 months student research project).

LET effects

The induction of DNA double strand breaks in one radiation event, represented by the α coefficient, is LET dependent and this should be reflected in the LET dependence of cell survival. Calculations using a simple track structure model and the fixed geometrical target of the DNA double helix have been made to determine the variation of the coefficient α with LET. The results have been compared with DNA double strand breaks measured in vitro and with cell killing of T_1 kidney cells given in the literature. A good agreement between the experimental results and the calculations was found and the difference between the results of Todd and Barendsen could be resolved and was explained as resulting from different track structure parameters coupled to a fixed geometry of a double target.

Mutations and Radiological Protection

The implications of the hypothesis for the induction of mutations and for radiological protection have also been considered.

Preliminary conclusions are:

- peak mutation rate is independent of radiation type and conditions.
- mutation spectrum is independent of radiation type but dependent on dose.
- biological effect at low dose is linear with dose and has no threshold.
- limiting RBE at low doses is same for mutations, aberrations and cell survival in same cell.

Publications

1. CHADWICK, K.H. and LEENHOUTS, H.P.: The molecular target theory of cell survival and its application in radiobiology (EUR 4918-e (1973) 52 pp).
2. CHADWICK, K.H. and LEENHOUTS, H.P.: A molecular theory of cell survival. *Phys. Med. Biol.* 18 (1973): 78-87.
3. CHADWICK, K.H. and LEENHOUTS, H.P.: Evidence for a dose rate effect in type B spermatogonia of the mouse at high dose rates. *International Journal of Radiation Biology* (1973) 23: 627-629.
4. LEENHOUTS, H.P. and CHADWICK, K.H.: DNA double strand breaks and chromosome aberrations. *Theoretical and Applied Genetics* (1973) (In Press).
5. CHADWICK, K.H. and LEENHOUTS, H.P.: A common molecular mechanism in radiobiology? Its implications in radiological protection. Presented at 3rd International Congress of the Radiological Protection Association, Washington (1973) (In Press).
6. LEENHOUTS, H.P. and CHADWICK, K.H.: The RBE-LET Relationship. Presented at 4th Microdosimetry Symposium, Verbania Pallanza (1973) (In press).
7. CHADWICK, K.H. and LEENHOUTS, H.P.: Chromosome aberrations and cell death. Presented at 4th Microdosimetry Symposium, Verbania Pallanza (1973) (In Press).
8. LEENHOUTS, H.P. and CHADWICK, K.H.: A theoretical analysis of radiation sensitivity in cells following neutron irradiation. Presented at IAEA Symposium on the Effects of Neutron irradiation upon cell function. Munich (1973) (In Press).

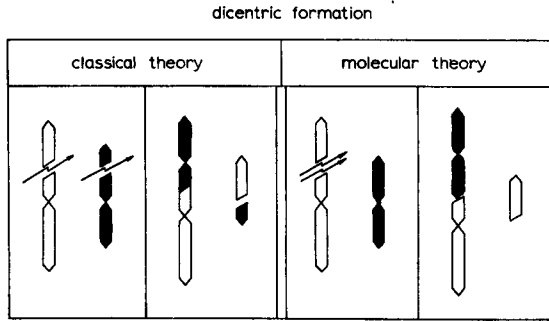

Figure 1. Schematic representation of the formation of a dicentric aberration according to the classical and molecular hypotheses.

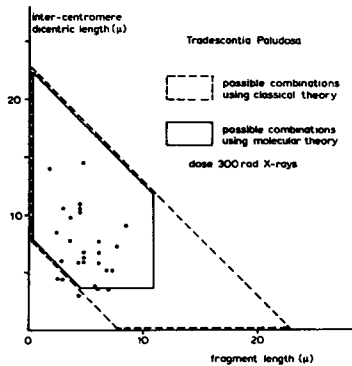

Figure 2. The dependence of intercentromeric distance and fragment length in dicentrics found in *Tradescantia paludosa*. The continuous line defines the area expected on the basis of the molecular hypothesis. The dotted line defines the area expected on the basis of the classical and exchange hypotheses.

Resultaten van het project No. 9

Hoofd van het team en wetenschappelijke medewerkers:

A.J.G. van Gastel, K. J. Puite en P. A. T. J. Werry

Titel van het project: Irradiation dose-mutation relation in the rad dose range.

Beschrijving van de resultaten:

A. Pollen germination studies using *Tradescantia paludosa*.

Tradescantia plants are well suited for the fundamental radiobiological research, which is carried out in direct relationship with the theoretical model studies of the molecular mechanism of radiation on biological tissue. The period of interphase of 5 days before first pollen mitosis is known to have a constant radiosensitivity, chromosomal aberrations can easily be scored at the metaphase of pollen mitosis, while the germinating ability of mature pollen is considered to be related to the intactness of the vegetative nucleus arising from the mitotic division. When the percentage of germinating pollen is plotted as a function of dose, curves can be obtained comparable with survival curves of mammalian cells.

Firstly, a method for germination of *Tradescantia* pollen in vitro has been developed, starting from data available in literature. The results of these experiments are collected in the ITAL External Report No. 9.

Each inflorescence contains a series of buds which are all in a different stage of development. Each bud contains a synchronous cell population. Irradiation of an inflorescence results in exposure of these cell populations which are also at different developmental stage. Under optimal climatic conditions one flower will open each day. Therefore, the effect of radiation can be studied over a whole range of pollen grain development. In figure 1 data are collected after exposure with different X-ray doses (2 mm Cu HVL, exposure rate 90 R/min). During the first 1-4 days after irradiation no influence of the doses given can be seen. These data correspond to pollen grains exposed after they have passed mitosis. Pollen exposed during interphase before their mitotic division (days 6-10) show a reduced germination percentage. A further reduction in germination takes place at day 11, 12 when the pollen have been exposed in their meiotic phase.

The proportion of pollen germinating after exposure with X-rays, during interphase is plotted in figure 2. The curve shows some similarity with cell survival curves.

B. Peroxidase activity of irradiated pollen of *Tradescantia paludosa*

Also another type of radiation damage caused during exposure may be scored with mature pollen, e.g. the lack of peroxidase activity in a pollen grain. The peroxidase activity can be detected by transferring mature pollen to 15 ml of a saturated benzidine solution to which 0.2 ml of a 3% H_2O_2 solution has been added. Pollen grains containing peroxidase become enlarged and are colored deeply blue. After about two hours the blue color is turned into brown.

A reduced peroxidase activity is found when the exposure has taken place during the interphase of pollen grain development. The results of an exposure during this stage is shown in figure 2. The proportion of pollen grains with peroxidase activity seems to follow a straight line when the data are plotted on a semi-logarithmic scale. Further experiments are directed towards an understanding of the basic mechanism of this effect and the relationship with germination curves.

Publications -- 1973

BOKELMANN, G.S. and K.J. PUITE. Germination of *Tradescantia paludosa* in vitro. ITAL External Report No. 9, 1973.

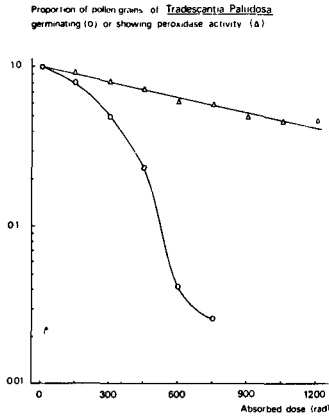

fig. 1. Percentage of pollen grains of *Tradescantia paludosa* germinating as a function of time after different X-ray doses (2 mm Cu HVL, exposure rate 90 R/min).

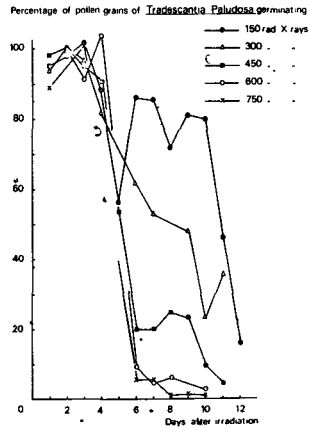

fig. 2. Proportion of pollen grains of *Tradescantia paludosa* germinating or showing peroxidase activity, when exposed to different X-ray doses (2 mm Cu HVL, exposure rate 90 R/min; data taken 7, 8 and 9 days after irradiation).

Resultaten van het project No. 10

Hoofd van het team en wetenschappelijke medewerkers:

K.H. Chadwick, K.J. Puite.

Titel van het project: Applied dosimetry.

Beschrijving van de resultaten:

A. Second EULEP intercomparison project on X-ray dose and dose distribution.

A second intercomparison project on X-ray dose and dose distribution has been carried out between various institutes cooperating within EULEP. The aim of this second project was to check the improvements made after the first intercomparison studies, while also this project was more directed to the actual exposure conditions at the various institutes. The work has been carried out in close cooperation with the Radiobiological Institute at Rijswijk and the Laboratorio di Dosimetria e Standardizzazione at Rome and the standardization laboratory of the National Institute of Public Health at Bilthoven.

A test phantom with the size of a mouse and containing LiF and BeO TL dosimeters had to be exposed together with additional mouse phantoms in the cage actually used for mice experiments at the participating institutes. From the TL reading of the dosimeters at the entrance, central and exit position in the phantom the absorbed dose actually given and the dose distribution over the phantom could be calculated.

The total uncertainties for both the LiF and BeO absorbed dose data are estimated to be ± 2.5 to $\pm 3\%$. The experimentally found mean difference between the two independent systems of $-0.5 \pm 3.1\%$ is within the expected limit of ± 4 to $\pm 4.5\%$.

It can be concluded from the results of the intercomparison that improvements have been made, although 3 out of 11 institutes still obtain absorbed dose values which are not within 5% of the standard dose and 3 out of 13 institutes are not able to fulfil the requirements of performing class A irradiations (i.e. a ratio of less than 1.15 between maximum and minimum absorbed dose).

B. Energy dependence of TL dosimeters in a phantom.

Intercomparison studies of dose and dose distribution in animal radiobiology using TL dosimeters have indicated the need to determine the TL response/rad in muscle within an animal phantom. To this purpose a mouse-sized test phantom containing TL dosimeters has been exposed to X-rays having a HVL

value of 1.4 - 2.8 mm Cu. Dependence of the response of ^7LiF dosimeters on HVL of the incident beam has resulted in an increase of TL response/rad in muscle for dosimeters positioned at the central axis of the phantom compared with the response of similar dosimeters exposed free-in-air. An increase of 7-3% in TL response/rad in muscle was found over the HVL range. The spread in effective energy inside the phantom was small and the dose distribution may be estimated directly from the TL response of ^7LiF dosimeters at the entrance, central and exit position in the phantom. It seems to be difficult to determine unique HVL values in a phantom using TL dosimeters.

C. TL measurements on BeO at low temperature.

Ceramic BeO material offers very good possibilities as TL dosimeter compared to routine systems as LiF and CaF_2 . BeO discs have been used successfully, together with LiF powder, in the second EULEP intercomparison project. However, the supralinearity of the TL response of BeO starting at about 30 rad may present difficulties for routine use. More insight in the mechanism of supralinearity is gained exposing BeO at liquid nitrogen temperature (LNT) and measuring the spectral emission of the TL glow curves in the temperature range from LNT - 300°C.

Spectral measurements have been carried out using X-ray doses of 5 krad for the -98, -116, +185 and 284°C glow peaks. These experiments have not yet been completed but the data obtained indicate that the various peaks all exhibit a similar emission spectrum. This may point to a simple mechanism of luminescence. The measurements will be repeated at doses of 50 krad.

Publications - 1973

PUITE, K.J. and D.L.J.M. Crebolder. Energy dependence of thermoluminescent dosimeters for X-ray and dose distribution measurements in a mouse phantom. Phys.Med.Biol., in press.

CHADWICK, K.H., W.R.R. TEN BROEKE and D. RINTJEMA. An intercomparison of read out systems for the clear perspex dosimeter. National and International Dose Intercomparisons. IAEA-PL-479/6 (1973) 33-40.

CHADWICK, K.H. Is dosimetry required in radiation processing. Dosimetry in Agriculture, Industry, Biology and Medicine IAEA, Vienna (1973) 3-9.

CHADWICK, K.H. The choice of measurement wavelength for clear-HX-perspex dosimetry. Dosimetry in Agriculture, Industry, Biology and Medicine. IAEA Vienna (1973) 563-568.

CHADWICK, K.H., J.J. TEN BOSCH and W.F. VERHELST. Mechanism involved in the effect of temperature and light on the clear perspex dosimeter. Dosimetry in Agriculture, Industry, Biology and Medicine IAEA Vienna (1973) 569-576.

CHADWICK, K.H. A standard procedure for the use of the clear perspex HX dosimeter in the dose range 1-10 Mrad. IAEA panel and Code of Practice for the Radiation Sterilization of Biomedical Products. In Press.

BROERSE, J.J. and K.J. PUITE. Comparisons of X-ray dosimetry for the coordination of late effects research in Europe. National and International Dose Intercomparisons IAEA-PL-479, 21-31 (1973).

RAPPORT D'ACTIVITE POUR L'ANNEE 1973

Contrat N° : SC 010/094-72-1 BIA N

Université Catholique de Louvain

Prof.H.Laudelout

List of scientists having contributed to this report :

Dr.R.Van Bladel, Dr.Tang Van Hai, Dr.Fageria.

Thème général du contrat : Movement of soil ions and their uptake by plants.

Project Nr 1: Ion Movement and Exchange in Soils.

Most of the work in 1973 has been carried out on the modeling of ion movement through soils and on the experimental determinations of the relevant parameters to be used as input in the models. Work is being done simultaneously on several sub-models to be later incorporated in a single large model which should allow a fairly wide range of forecasting actual situations. One of the submodels which is now operating satisfactorily describes the movement of cations through the soil under saturated conditions taking account of exchange and solubility reactions. The novel feature of this submodel consists in that the full ion exchange isotherms are taken into account rather than empirical exchange relationships as done previously. This has enabled us to make full use of the fundamental data collected in this laboratory on ion exchange thermodynamics. A second submodel is now in the process of development, its purpose is the description of mineral nitrogen transformation as it moves down the soil profile. Again the relevant parameters are determined experimentally or are taken from previous work done in this laboratory on the kinetics of nitrifying bacteria. A very satisfying agreement between the predictions of the model and the observed rate of transformations of mineral nitrogen has been found in mixed cultures of nitrifiers.

Project Nr 2 : Uptake of Solutes by Plants from a Dilute Environment.

The work carried out during 1973 has been concerned with the uptake of P, K, Mg and Ca by the rice plant (*Oryza sativa* L. R 8) from dilute solution with various concentrations of a given element keeping all the others constant. With regard to P the range of deficiency symptoms is 0.16-3.2 μM ,

for K the range is 51-102 μM , for Ca : 6.2-12.0 μM .

No symptoms of Mg deficiency were recorded at the lowest concentration used (8 μM). Maximum growth was observed at 200-250 μM Ca, 10-25 μM , P, 125-250 μM K and 30-32 μM Mg.

The uptake of N by the same plant was then investigated using optimal concentrations of P, K, Ca and Mg. The range of N concentrations was very broad (70 to 7140 μM as ammonium sulfate. At low N concentrations (below 285 μM) deficiency symptoms were observed. A threefold increase in dry matter production was observed up to about 3 mM nitrogen. Root growth was found to have an inverse relationship with nitrogen concentration, maximum root length being observed at the lowest nitrogen concentration.

A kinetic analysis of the rate of nitrogen uptake vs. nitrogen concentration showed that a Michaelis type of relationship obtained.

The K_m value did not change with age and remained at .2 to .25 mM while the V_m decreased with age from 5.8 $\text{mg.g}^{-1}\text{h}^{-1}$ for 25 day old plants to .9 $\text{mg.g}^{-1}\text{h}^{-1}$ for 100 day old plants expressed on the basis of the dry root weight.

The work has also been extended to the uptake pattern of N, P, K, Ca and Mg at varying levels of N by the Soy bean plant (*Glycine max.* L. Merr.). Saturation of the NH_4^+ absorption mechanism was observed at .7 mM. It was observed that inoculation of the Soybean plant depressed the V_m value of the Michaelis relationship without affecting K_m .

Publications :

- H. LAUDELOUT. La modélisation des Processus Pédologiques de drainage et d'irrigation.
Hommes, Terre et Eaux, n°7, 129-133, 1973.
- F. MOUGENOT et A. GALLEZ. L'accumulation sélective du Magnésium dans les Sols : Mécanisme et influence sur la Croissance et la Nutrition du Ray-Grass d'Italie.
Ann. agron., 24(4), 457-464, 1973.
- TANG VAN HAI et J.P. ROLLAND. Cinétique de l'absorption du phosphore et du potassium par les plantes intactes d'arachides en solutions diluées.
Oléagineux, n°11, 517-520, 1973.

Université Catholique de Louvain

N° 096-72-1 BIO B

A. GOFFEAU

Transport des radionuclides par les membranes biologiques.

In 1973, the choice of yeast to study the transport mechanisms of radionuclides through biological membranes has definitively been proven to be appropriated. The multiple possibilities to submit this simple and fast growing eukariot to physiological and genetical modifications have permitted experimental approaches which would have been not possible with slow growing plant or animal cells. Progresses have been made in three directions.

1. A systematic study of the pronounced stimulation by strontium of mitochondrial oxidations, discovered last year, has permitted to localize this effects at the level of the external NADH dehydrogenase of the inner mitochondrial membrane (reference 1). 2. Our collection of distinct stable respiratory-deficient pleiotropic respiratory-deficient mutants of chromosomal heredity obtained by X-irradiation has been further characterized both biochemically and genetically (references 2 to 7). Now that a new procedure to isolate mitochondria from these mutants has been developed (reference 8) it becomes possible to use these strains modified in several distinct mitochondrial membrane proteins as new tools to further study the physiological role of strontium on mitochondrial activities. 3. The use of another set of mutants has permitted to detect a marked stimulation of cell permeability by 3',5' cyclic AMP (reference 9). It has not been checked whether the permeability of specific radionuclides is also affected but the possibility to use yeast mutants to further study this effect opens a new approach which is not possible in other eukariot cells (see the Comments and News of Nature of 7 September 1973).

References

1. A. SOUCHAY - Stimulation des oxydations mitochondriales de levure par les cations alcalino-terreux.
Thèse Ingénieur-Docteur, Université de Paris VI (1973).
2. A. GOFFEAU, Y. LANDRY, F. FOURY, M. BRIQUET and A.M. COLSON - Oligomycin resistance of mitochondrial adenosine triphosphatase in a

- pleiotropic chromosomal mutant of a "petite-negative" yeast, Schizosaccharomyces pombe.
J. Biol. Chem. 248, 7097-7105 (1973).
3. A.M. COLSON, C. COLSON and A. GOFFEAU - Systems for membrane alteration. Genetic perturbations of mitochondria in a "petite-negative" yeast.
Methods in Enzymology, 32 (1974, sous presse).
4. Y. LANDRY and A. GOFFEAU - Dual effect of dicyclohexylcarbodiimide on rat liver and yeast mitochondrial ATPase.
Arch. Int. Physiol. Biochim. 81, 590-591 (1973).
5. A. GOFFEAU, A.M. COLSON, Y. LANDRY, F. FOURY and M. BRIQUET - Stable nuclear pleiotropic respiratory-deficient mutants with modified mitochondrial cytochrome $a+a_3$ and adenosine triphosphatase in a "petite-negative" yeast Schizosaccharomyces pombe.
The Biochemical Journal (sous presse).
6. A. GOFFEAU, Y. LANDRY, F. FOURY, M. BRIQUET and A.M. COLSON - A single-gene chromosomal mutation causing pleiotropic mitochondrial deficiencies in a "petite-negative" yeast.
Abstracts of Ninth International Congress of Biochemistry, Stockholm, 1-7 July 1973, Abstract 5m 9.
7. A. GOFFEAU, A.M. COLSON, Y. LANDRY, F. FOURY and M. BRIQUET - Stable pleiotropic chromosomal mutations with modified mitochondrial ATPase and cytochromes aa_3 and b in Schizosaccharomyces pombe.
Abstract International Symposium on Biomembrane (Madurai, India) December 1973.
8. F. FOURY and A. GOFFEAU - Combination of 2-deoxyglucose and snail-gut enzyme treatments for preparing sphaeroplasts of Schizosaccharomyces pombe.
J. Gen. Microbiology, 75, 227-229 (1973).
9. F. FOURY and A. GOFFEAU - Stimulation of yeast RNA synthesis by cycloheximide and 3',5' cyclic AMP.
Nature N.B., 245, 44-47 (1973).

Projet N°1

A. GOFFEAU, A. SOUCHAY, M. BRIQUET, A.M. COLSON, Y. LANDRY, F. FOURY
Transport des radionuclides par les mitochondries isolées de levure.

The site of action of strontium in the marked stimulation of NADH oxidation by isolated yeast mitochondria was further studied. Potential carriers for strontium were extracted with lithium 3,5 diiodosalicylate from sonicated yeast submitochondrial particles. This extract contained six distinct peptides which after separation by acrylamide gel electrophoresis in the presence of sodium dodecyl sulfate were stained by the Schiff reagent. The study of the possible glycoproteic nature of these peptides has however not been pursued. Indeed, the stimulation by strontium of the oxidation of external NADH by intact yeast mitochondrial was found to be not specifically inhibited neither by lanthanum and cerium chlorides, by ruthenium red ($\text{RuCl}_4(\text{OH})_2 \cdot 7\text{NH}_3 \cdot 3\text{H}_2\text{O}$) nor by cobalthexamine chloride ($\text{Co}(\text{NH}_3)_6\text{Cl}_3$). Since these compounds are known to inhibit the fixation of calcium and strontium by rat liver mitochondrial glycoproteins, it became very unlikely that such glycoproteins were involved in the stimulations that we observed in yeast.

The possible involvement of phospholipids was also considered unlikely since butacaine ($\text{NH}_2\text{-C}_6\text{H}_4\text{-COO}(\text{CH}_2)_3\text{-N}(\text{C}_4\text{H}_9)_2$) was found not to modify the strontium-induced stimulations. Moreover, since two strontium ionophores were also ineffective we concluded that strontium was probably acting from the outside of the mitochondrial membrane. This conclusion led us to assay the NADH : ferricyanide oxidoreductase localized at the outside of inner mitochondrial membrane. This enzyme was found to be stimulated by 300% by strontium in intact mitochondria as well as in sonicated submitochondrial particles. This recent observation opens the possibility to study the effect of strontium on the level of the solubilized enzyme. Such a molecular approach will be facilitated by the use of mutants modified in the inner mitochondrial membrane. Genetical methods to induce, by X-irradiation and other mutagens, such mutants in the yeast Schizosaccharomyces pombe have been described. Although the mutation is of chromosomal origin, the deficiencies were found to concern activities partially controlled by the mitochondrial DNA. A dozen of distinct mutants were classified according to genetic (complementation groups) and biochemical (cytochromes aa_3 , b, c and oligomycin-sensitive ATPase) criteria. The study of NADH dehydrogenase and of the physiological function of strontium in these mutants is now becoming possible since a

method has been devised for the isolation of yeast mitochondria from sphaeroplast obtained by the combined use of deoxyglucose, snail-gut extracts and an enzyme isolated from *Arthrobacter luteus*.

Résultats du projet N°2

A. GOFFEAU, E. MRENA, F. FOURY, J. DELHEZ

Etude du rôle de la membrane plasmique dans le transport des radionuclides.

The synthesis of RNA was found to be stimulated by cycloheximide in the mutant COB5 of Schizosaccharomyces pombe put in starvation. This observation, similar to the bacterial so-called stringent control, led us into the investigation of the control by yeast cell membranes of the transport of uridine and to the discovery that 3',5' cyclic AMP was markedly stimulating the plasmic membrane permeability. This stimulation concerns the V_{\max} (but not the K_M) of all tested amino-acid (aspartic, glycine, lysine, tryptophane, valine, leucine) as well as uridine and adenosine, but not guanosine. This effect of 3',5' AMPc is observed under starvation conditions but needs a functional source of ATP synthesis either by glycolysis or by respiration. The main interest of this observation is that it is the first report of an effect of 3',5' cyclic AMP on the permeability of cells which can be used conveniently for genetic studies. This system has now been sufficiently characterized to permit the investigation of the effects of 3',5' cyclic AMP on the permeation of strontium and other radionuclide.

GENETISCHE STRAHLENWIRKUNGEN

HEREDITARY EFFECTS OF RADIATION

EFFETS HEREDITAIRES DES RAYONNEMENTS

Weitere Forschungsarbeiten zu diesem Thema werden auch in folgenden Jahresberichten beschrieben:

Further research work on these subjects will also be described in the following annual reports:

D'autres travaux sur ce thème de recherche sont également décrits dans les rapports annuels suivants:

O94-BIAN ITAL, Wageningen (De Zeeuw)

Contract No. 102 - 72 - a 1 BIAN

Project No. A 1

Laboratory for Molecular Genetics, State University of Leiden,
The Netherlands (in collaboration with the Medical Biological
Laboratory TNO, Rijswijk 2100)

Title: STUDY ON THE MECHANISM OF MUTATION IN ANIMAL AND HUMAN CELLS

Summary:

Mammalian cells are capable of repairing DNA damage induced by physical and chemical agents. Although the molecular mechanism of these repair processes remain largely unknown, an "excision repair" process, analogous to that found in many prokaryotic systems, has been shown to occur following the ultraviolet irradiation of mammalian cells. This process involved (i) the recognition of the damage and an endonucleolytic scission near the damaged site, (ii) the physical removal of the damage, (iii) resynthesis of the excised region and (iv) the resealing of the DNA chain. The resynthesis of the excised region is known as "repair replication" and has been used as a measure of the repair process. Alternatively, another step in the excision repair process can also be studied: the incision step. In these studies use is made of a UV-specific endonuclease isolated from Micrococcus luteus. This endonuclease is capable of specifically "incising" the DNA next to the UV-induced pyrimidine dimer. By measuring the number of endonuclease specific sites (ESS) present at a given time after UV irradiation, it is possible to determine the rate of the incision process in the cell itself. Data obtained from normal and UV-sensitive human cell lines as well as chicken cell lines are presented in this study.

A UV and γ -specific nuclease has been identified in both human cell lines and calf thymus cells. Progress has been made in the purification and characterization of this repair enzyme.

The expression of the H1-A histo-compatibility antigens in man/Chinese hamster hybrids has been correlated with the presence or absence of 27 human enzymes and evidence was obtained for large syntenic groups on chromosome 1 and chromosome 6. By studying spontaneous and irradiation-induced translocation the sequence of five genetic markers on chromosome 1 was determined.

Studies with human peripheral blood lymphocytes on the dose-effect relationship for 250 kV X-rays, 16 MeV electrons and 15 MeV neutrons have shown neutrons to be about twice as effective in the induction of chromosome aberrations than either electrons or X-rays. The influence of temperature, PHA stimulation and other parameters was examined.

Project No. A.1.1

Title: The induction of chromosome aberrations by physical agents

Research workers: Drs.H.Heering, Prof.Dr.D.Bootsma, Dr.S.Bacchetti

Progress report:

Studies of the dose effect relationship after irradiation with 250 kV, 15 mA X-rays, 16 MeV electrons and 15 MeV neutrons, have been continued. X-rays and electrons are equally effective in aberration induction. Neutrons are about twice as effective as either X-rays or high energy electrons.

There was no significant difference in the induction of chromosome aberrations when the stimulation with PHA was done 30 min before or either 4 or 16 hours after irradiation. There was also no difference in aberrations when the experiments were done at room temperature or at 37°C. In the cases of the whole blood irradiation experiments, or of blood in culture medium during irradiation, one result was not significantly different from its control while in the other experiment there was a slightly significant shift towards lower aberration frequencies.

The project will be completed in 1974. A final report will be prepared.

Project No. A.1.2

Title: Repair of radiation damage in mammalian cells

Research workers: Dr.G.Veldhuisen, Dr.P.H.M.Lohman, Dr.S.Bacchetti,
Dr.R.Oosterbaan, Dr.M.G.Paterson

Progress report:

Living cells are able to repair damage caused by physical or chemical agents. These studies are limited to the examination of the removal of UV-irradiation damage. In previous studies emphasis has been placed upon the excision repair process using repair replication as an important parameter to measure excision repair. Another step in the excision repair process can also be followed: the incision step. An assay has been developed which employs a UV-specific endonuclease purified from Micrococcus luteus. This enzyme acts specifically at sites containing pyrimidine dimers in UV-irradiated DNA. To investigate incision kinetics primary human fibroblasts were irradiated with ultraviolet light, the radioactively labelled DNA isolated, treated with UV-endonuclease and analysed by sedimentation in an alkaline sucrose gradient. Immediately following irradiation endonuclease susceptible sites (ESS) are observed. These sites disappear with time : in wild-type cell lines 9 hours after a UV-dose of 65 ergs/mm² about 70% of the ESS have disappeared. It was also found that a UV-dose of 100 ergs/mm² (10⁶ thymine dimers/cell) was the saturation level for the cellular incision system.

The rate of disappearance of ESS vs time of post-UV irradiation in repair-deficient Xeroderma pigmentosum (XP) cells is much lower than in normal cell lines. After 30 hours of post-irradiation incubation about 85% of the ESS originally induced in XP cells are still present compared with 30% still present in wild-type cell lines. This is true for all the XP cell lines tested (both classical and De Santes-Cacchione types) except for the intermediate XP-5 cell line which shows an intermediate response.

The UV-endonuclease test was also used to show that the number of ESS are efficiently removed from UV-irradiated multi-nucleate heterocaryons of XP-cells provided that the heterocaryons were constructed from different complementation groups as determined by complementation in repair replication.

The study of repair mechanisms was extended to chicken cells. It is known that chicken cells are able to photoreactivate thymine

dimers and this was continued with the UV-endo assay. When the chicken cells are incubated in the dark the dimers do not disappear from the DNA while the cells do show some repair replication (about 30% of the human level). It has been tentatively concluded that in chicken cells, damage other than dimers are being repaired more efficiently than the dimers.

Heterocaryons of chicken and XP cells were constructed and it was shown that dimers in XP-DNA contained in these multinucleate complexes were split by the PFR enzyme of the chicken. The monomerisation occurred after an initial lag period of circa 8 hours. Heterocaryons of chicken and normal human cells were also constructed. In this case the dimers in the chicken DNA disappeared in the dark. No lag period was observed for this reaction.

Studies were initiated on a UV-sensitive Chinese hamster cell line (B14). The survival of B14 cells following UV-irradiation is lower than that of the parent strain (B12). The level of repair replication in both cell lines are, however, identical.

Extracts from nuclei isolated from cultured human cells were used as a source for the isolation of human repair enzymes. An endonuclease acting upon UV and γ -irradiated DNA was detected and partially purified by DEAE-cellulose chromatography. Two active peaks were observed, both having the same substrate specificity. Gel filtration studies show the enzyme(s) to have a molecular weight of between 10-20,000 daltons. The lability of the enzyme(s) and the limited source of material (i.e. human cells) hampered these studies and calf thymus was used instead as a source of the enzyme(s).

Project No. A.1.3

Title: Genetic studies on in vitro cultured human and mammalian cells

Research workers: Dr.A.Wetserveld, Drs.H.van Someren

Progress report:

Hybrid cell lines obtained after fusion of Chinese hamster cells with human fibroblasts or lymphocytes show a preferential loss of human chromosomes. Since most of the homologous enzymes of man and hamster are electrophoretically distinguishable it is possible to establish linkage groups. The association of genetic markers can be established by their simultaneous retention or loss; the presence or absence of specific phenotypes and specific chromosome presumes the linkage of a particular chromosome.

The expression of the HL-A histocompatibility antigens in man/Chinese hamster hybrid cells has been correlated with the presence or absence of 27 human enzymes. Evidence has been obtained showing the HL-A locus to be syntenic with the loci for the enzymes PGM3, ME and GPD-B. These loci have been assigned to chromosome 6. Two other loci, FH and UGPP were added to the syntenic group PGD, PGM and PepC. This group of five markers is located on chromosome 1.

The sequence of the loci on chromosome 1 was determined by studying spontaneous and radiation-induced translocations in hybrid cell lines. The results show that the 6PGD and PGM are located on the distal part of the short arm and the loci FH, UGPP and PepC are located on the long arm. Using similar techniques, efforts to determine the sequence of the loci for G6PD, PGK, HGPRT and α -GAL on the X-chromosome are in progress.

This project is expected to be completed during 1974.

Contract No. 102-72-a 1 BIAN

Project No. A 2

Laboratory for Molecular Genetics, State University of Leiden,
The Netherlands (in collaboration with the Medical Biological
Laboratory TNO, Rijswijk 2100)

Title: THE IDENTIFICATION OF ENZYMES AND GENES WHICH ARE
INVOLVED IN THE REPAIR OF RADIATION DAMAGE IN BACTERIA

Summary:

The study of the repair processes in bacteria has provided our basic knowledge about the repair systems in general. In this project two organisms capable of repairing UV and X-ray induced damage, have been studied: Escherichia coli and Micrococcus luteus.

An ATP-dependent exonuclease thought to be involved in both recombination and repair in Micrococcus luteus has been purified and its mode of action characterized. The enzyme binds only to linear double-stranded DNA (with even or almost even ends). This binding is ATP-independent but does require Mg^{++} . The products of the reaction after the addition of ATP have been examined and they are (1) acid-soluble oligonucleotides of varying lengths, (2) acid-insoluble pieces of DNA which may be partially double-stranded and (3) the leftover DNA substrate having a small (\pm 80 nucleotides) single-stranded end.

Two new nuclease activities have been detected in E. coli: an exonuclease which is both Mg^{++} and ATP-independent and present in equal amounts in PolA, RecA, B and C and wild type strains, and an endonuclease which is more active in RecA extracts than in wild type extracts.

The role of DNA polymerase I in the excision repair process has been clarified by the results of studies of three DNA polymerase mutants of E. coli, polA1, polA107 and resA1. It was found that the ResA1 strain was incapable of pyrimidine dimer excision and no UV-induced repair replication was observed. The PolA107 strain which misses the 5'-3' exonucleolytic activity normally associated with DNA polymerase I shows a decreased dimer excision rate and only low levels of repair replication while the PolA1 strain believed to have an activated 5'-3' exonucleolytic activity showed near normal levels of dimer excision, excessive DNA breakdown and very high levels of repair replication.

Project No. A.2.1

Title: Studies in vitro to elucidate the mechanism of repair processes

Research workers: Dr.R.A.Oosterbaan, Drs.A.Hout, Ir.B.van Dorp,
Drs.H.L.Heijneker, Dr.B.W.Glickman, Dr.Ir.P.van de Putte,
Dr.P.H.Pouwels, Dr.Ir.C.A.van Sluis

Progress report:

1) The mechanism of action of the ATP-dependent DNAase from Micrococcus luteus, an enzyme believed to be involved in the process of genetic recombination, has been investigated using extensively purified enzyme (50% pure).

Glycerol gradient sedimentation analysis as well as phage partition experiments have shown that the enzyme forms a stable complex with linear double-stranded DNA, but not with single-stranded or circular double-stranded DNA. For this reaction Mg^{++} is required, but not ATP. One enzyme molecule can attach to each end of a linear DNA molecule.

Degradation is a first-order reaction; the rate being proportioned to the concentration of the DNA-enzyme complex. At 0°C one enzyme molecule requires 30 min to degrade one DNA molecule.

In the early stages of degradation of T7 DNA the following products are formed:

- (i) acid soluble, dialysable material representing about 35% of the degradation products;
- (ii) material of relatively low molecular weight (from a few to about 300 nucleotides in length). These molecules are acid-insoluble and for a large part single-stranded, though some, if not all, are partially double-stranded;
- (iii) material of relatively high molecular weight consisting of molecules with single-stranded regions, with an average length of 80 nucleotides, at their ends;

2) The role of DNA polymerase I in the repair of UV damaged DNA has been furthered by investigating the mutated polymerase of the UV-sensitive PolA107 strain. DNA polymerase I isolated from the PolA107 strain has the same molecular weight as wild type DNA polymerase I but is deficient in the 5'-3' exonucleolytic activity of this enzyme. By means of subtilisine treatment mutant and wild type enzymes were split into a "large" and a "small" fragment. The "large" fragment contains

the 5'-3' polymerase and the 3'-5' exonucleolytic activity of the enzyme, while the "small" fragment which normally demonstrated the 5'-3' exonucleolytic activity was defective in the case of the PolA107 mutant. This confirms the results of the early studies on the PolA107 polymerase.

3) Studies of the nuclease activities present in RecA strains of E. coli have resulted in the detection of two previously unidentified nucleases (i) an exonuclease which is both Mg^{++} and ATP-independent and present in equal amounts in polA1, recA, B, C and wild type strains, and (ii) an endonuclease which is more active in RecA extracts than wild type extracts. These two enzymes work synergistically in the degradation of ^{32}P -labeled E. coli DNA.

Project no.: A.2.2 and A.2.3

Title: Identification of gene products determining radiation-sensitivity of bacteria

Research workers: Dr. Ir. P. van de Putte, Drs. A. Hout, Dr. F. Palitti, Dr. B. W. Glickman, Dr. Ir. C. A. van Sluis

Progress report:

The repair of UV-damaged DNA in bacteria by the excision repair process is believed to involve a UV-specific endonucleolytic cleavage, a polymerase-exonucleolytic step followed by a ligase step. DNA polymerase I is a theoretical candidate for the excision repair pathway as it has been shown (a) that the 5'-3' exonucleolytic activity of DNA polymerase I is capable of removing pyrimidine dimers from UV-irradiated uv-endo treated DNA in vitro and (b) that a mutation affecting DNA polymerase I results in UV-sensitivity.

In order to clarify the relationship between DNA polymerase I and the repair of ultraviolet light damage a number of polA mutations were examined for their effect upon repair. The mutations studied were the polA1 mutation, originally isolated by De Lucia and Cairns, polA107, isolated in our laboratory, and resA1 isolated by Kato and Kondo. Extracts from both the PolA1 and ResA1 strains are deficient in DNA polymerase I polymerising activity but have retained the 5'-3' exonucleolytic activity normally associated with polI. Extracts of the PolA107 strain, however, lack the 5'-3' exonucleolytic activity but not the polymerising activity of polI. Some of the properties of the strains have been summarized in the table below:

	<u>polA1</u>	<u>polA107</u>	<u>resA1</u>
UV sensitivity	high	moderate	high
Host Cell Reactivation(UV)	intermediate	intermediate	intermediate
Host Cell Reactivation(MMS)	deficient	deficient	deficient
Replication of λ red	deficient	deficient	normal
Viable with <u>uvrE</u> ?	no	yes	no
Viable with <u>recA</u> , <u>B</u> or <u>C</u> ?	no	no	no
DNA Degradation after UV	extensive	moderate	extensive
Excision of Pyrimidine Dimers	fast	intermediate	none
Level of Repair Replication	high	low	none

On the basis of the rate of dimer excision and the levels of repair replication found in the mutants, clear evidence is obtained to show that DNA polymerase I is involved in in vivo excision repair. The almost normal excision rate in the PolA1 strain can be ascribed to the retained 5'-3' exonucleolytic activity of polI with "long patch" repair as a consequence. Dimer excision in the PolA107 strain may proceed via strand-displacement rather than degradation. The lack of dimer excision in the ResA1 strain (likely) reflects a difference in the in vivo action of the mutated polymerase I as compared to its behaviour in the PolA1 strain.

Project no. A.2.4

Title: The isolation of well defined multiply marked mutants
of Escherichia coli

Research workers: Prof.Dr.A.Rörsch, Dr.Ir.P.van de Putte,
Dr.I.E.Mattern, Dr.B.W.Glickman

Progress report:

The construction of the major part of the well defined set of Escherichia coli K12 strains has been completed. Strains are now available which will allow the construction of practically any combination of mutations affecting radiation-sensitivity. Moreover, the effect of these mutations upon mutation induction, including transitions, transversions and deletions, can be conveniently studied. Two of the strains which will become the bases for future investigations are LB 1926 (ara-101, TonA101, lacZ1, proC65, galA21, trp-101, his-51, pheA1, thyA301, serA101, argG168, metA79, metE72, malB78, dna-3017), and LB 1929 (thr-1, proC65, galA21, cysB125, lysA25, xyl-5, rha-103, purA202).

The extensive network of well characterized strains is presented in the pedigree map.

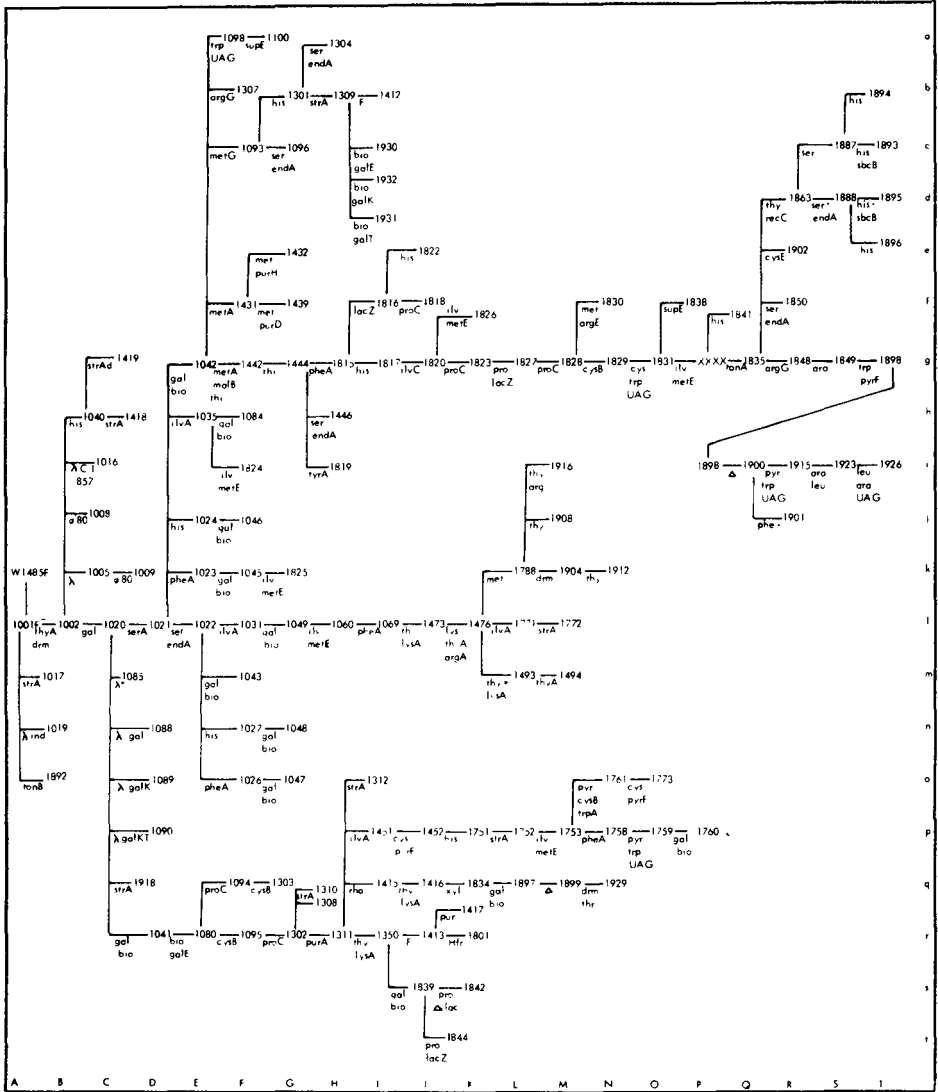

Contract No. 102-72-a 1 BIAN

Project No. A 3

Laboratory for Molecular Genetics, State University of Leiden,
The Netherlands (in collaboration with the Medical Biological
Laboratory TNO, Rijswijk 2100)

Title: IDENTIFICATION OF THE PRIMARY LESIONS INDUCED BY
IONIZING RADIATION

Summary:

Ionizing radiation results in single-and double-strand breaks as well as nucleotide damage. While double-strand breaks account for about 7% of the lethality when PM2 DNA is irradiated in nutrient broth at -196° , more than 80% of the lethal damage is of the nucleotide type. By examining the biological activity of ϕ X174 irradiated under similar conditions it was shown that not all nucleotide damage is lethal.

The minimum distance between two single-strand breaks in opposite strands of DNA which does not result in a double-strand break was found to be 5 nucleotide pairs in T4 and T7 DNA but 16 nucleotide pairs in PM2 DNA. Further purification of the T4 and T7 DNA yields results similar to that of the PM2 DNA.

ϕ X174 DNA irradiated under N_2O in the presence of phenylalanine causes damage which is repairable in the host cell reactivation test but treatment of this DNA with the UV-specific endonuclease isolated from M. luteus does not increase the biological activity upon uvrA spheroplasts suggesting that the E. coli system has a different specificity. A γ -ray specific endonuclease was detected in M. luteus extracts.

Mutation induction in T7 DNA by γ -rays results in a compound dose-effect curve which is the affect if a linear plus an exponential response. The exponential response was not observed with polymerase I deficient cells.

In pulse radiolytic experiments the reaction of radiation induced water radicals with purine derivatives leads to the formation of a formamide-pyrimidine derivative, a compound without an intact imidazole ring. The first order change in absorption spectra suggests that this reflects the direct attack of the water radical on the five-membered ring.

Sensitization of cells to ionizing irradiation by the well-known sensitizers paranitroacetophenone (PNAP) and triacetoneamine-N-oxyl (TAN) can be prevented by the presence of low concentrations of reducing agents such as cysteamine and vitamine C. It was also

shown that at least some of the TAN- γ -ray radiation product can be repaired by the host cell repair system in E. coli, as DNA so treated results in a lower biological activity when tested upon uvrA spheroplasts than wild-type spheroplasts.

Project No. A.3.1

Title: Induction of mutations in bacterial and mammalian cells and viruses and in biologically active DNA by physical and chemical agents

Research workers: Ir.J.F.Eleichrodt, Dr.R.A.Oosterbaan

Progress report:

Evidence is presented that two mechanisms are involved in the radiation-induced reversion of amber mutants of bacteriophage T7 to pseudo wild-type particles. One shows an efficiency of induction of mutants which is independent of dose, the other shows an increase in the efficiency with dose. The latter does not occur when the host bacterium is deficient in polymerase I. Both types of induction are more efficient under oxic than under anoxic conditions.

Project No. A.3.2 and A.3.3

Title: Chemical and physical identification of lesions in nucleic acids

Research workers: Ir.J.F.Bleichrodt, Drs.J.J.van Hemmen, Dr.J.de Jong, Dr.G.P.van der Schans

Progress report:

1) When the double-stranded circular DNA of the bacteriophage PM2 is irradiated in nutrient broth at -196° , conditions under which the direct effect of radiation predominates, nucleotide damage is the main cause of inactivation. Nevertheless, an important part of the damaged nucleotides is non-lethal. Double-strand breaks contribute little (7%) to inactivation and the majority of the single-strand breaks is non-lethal. These results are similar to those obtained previously for the indirect effect of radiation.

2) The smallest distance (a) between two single-strand breaks in DNA in opposite strands that does not result in a double-strand break has been found previously to be different for the DNA of the bacteriophages T7 and T4 on the one hand (a = 5 nucleotide pairs) and PM2 on the other (a = 16). It has been shown that this difference is mainly due to an artifact. In T4 and T7 DNA extra single-strand breaks are produced by the alkali treatment after irradiation, which is necessary for the determination of the number of single-strand breaks. In PM2 DNA practically no extra single-strand breaks are produced by alkaline denaturation. After an extra purification of T7 DNA this effect of alkali was absent.

3) In collaboration with the Institute of Physical Chemistry of the University of Bonn an investigation was started on the usefulness of pyrolysis field desorption mass spectrometry for the detection of relatively small amounts of radiation products in DNA. Due to a number of technical problems no definite answer can be given at the moment.

4) The biological activity of the "replicative form" DNA of bacteriophage ϕ X174 irradiated with gamma rays under N_2O in the presence of phenylalanine is lower when measured upon a bacterial strain containing a uvrA mutation than upon the wild-type strain. Attempts to enhance the biological activity on a uvrA strain by treatment of the irradiated DNA with a UV-specific endonuclease from Micrococcus luteus failed. On the other hand, it could be shown that an extract of Micrococcus luteus contains a gamma ray

specific endonuclease, since it induced 1.3 single-strand breaks per radiation-induced single-strand break in PM2 DNA which has been irradiated in the presence of phenylalanine. PM2 DNA irradiated in plain buffer, however, contains also endonuclease sensitive sites.

5) In pulse radiolytic experiments it is possible to study the reactions of the separate radiation-induced water radicals with purine-derivatives (adenine, purine, hypoxanthine, xanthine, 2-aminopurine, guanine, isoguanine and uric acid). The absorption spectra obtained after reaction of OH^\bullet radicals with these compounds (except purine) change immediately after the pulse according to first order kinetics. The initially observed absorption spectra are not a superposition of spectra of different radicals and the alteration of the spectrum is independent of the concentration of the purine derivative. Such processes have also been observed in DNA. From the mixture of radiation products of the purine derivatives (not purine itself) a formamido-pyrimidine derivative, a compound without an intact imidazole ring, can be isolated. This suggests that the first order change in the spectrum reflects the opening of the five-membered ring. This research is done in collaboration with the Interuniversitair Reactor Instituut, Delft.

6) If an oxygen free solution of cysteamine is added to an oxygen free solution of bacteriophage PM2 DNA which has been irradiated about one millisecond before with 3MeV electrons, a higher biological activity remains than after addition of oxygen free buffer. The number of single-strand breaks in the DNA appeared to be halved after mixing with cysteamine. Cysteamine is not able to reduce the fraction of lethal nucleotide damage one millisecond after irradiation of the DNA. This research has been performed in collaboration with the Interuniversitair Reactor Instituut, Delft.

7) Irradiation of the double-stranded "replicative form" DNA of the bacteriophage ϕ X174 in the presence of the radiosensitizer TAN (2,2,6,6,-tetramethyl-4-piperidone-N-oxyl) induces reactions which presumably lead to the formation of adducts between DNA and TAN. Comparison of the biological activity of DNA irradiated in the presence of TAN in a uvrA mutant of Escherichia coli K12 with that in a wild-type strain showed that in the presence of TAN lesions are produced which can be repaired at least partly by the excision repair system.

In a cell the DNA is surrounded by many chemical compounds. These compounds may react with radiation-induced damage in DNA or radiation-induced radicals of these compounds may react with DNA. It has been shown in in vitro experiments that sensitizers and oxygen influence one or more of these radiation induced reactions of cell components with DNA. These experiments were carried out with solutions of biologically active DNA in an extract of bacteria or human cells. Oxidizing compounds like oxygen, TAN and PNAP (paranitro acetophenone) and diamide sensitize DNA to gamma irradiation. Small concentrations of reducing compounds like cysteamine and vitamine C protect the DNA against radiation.

PUBLICATIONS

W. J. Kleijer, J. L. Hoeksema, M. L. Sluyter and D. Bootsma

Effects of inhibitors of DNA-repair in normal human and Xeroderma pigmentosum cells after exposure to X-rays and ultraviolet light. *Mutation Res.* 17, 385, 1973

B. van Dorp, M. Th. E. Ceulen, H. L. Heijneker and P. H. Pouwels

Properties of an ATP-dependent deoxyribonuclease from Micrococcus luteus. Evidence for a stable DNA-enzyme complex. *Biochim. Biophys. Acta*, 299, 65, 1973

A. Hout and A. Schuite

The measurement of the ATP-dependent nuclease in crude extracts of wild-type and RecA cells of Escherichia coli. *Biochim. Biophys. Acta*, 308, 366, 1973

J. H. Iupker, B. W. Glickman, A. Rörsch and L. Bosch

Killing of ³²P-labelled single-stranded-RNA bacteriophage MS2. *Eur. J. Biochem.*, 35, 206, 1973

M. C. Paterson, P. H. M. Lohman and M. L. Sluyter

Use of a UV endonuclease from Micrococcus luteus to monitor the progress of DNA repair in UV-irradiated human cells. *Mutation Res.* 19, 245, 1973

B. W. Glickman, C. A. van Sluis, H. L. Heijneker and A. Rörsch

A mutant of Escherichia coli K12 deficient in the 5'-3' exonucleolytic activity of DNA polymerase I. I. General characterization. *Mol. Gen. Genetics*, 124, 69, 1973

H. L. Heijneker, D. J. Ellens, R. H. Tjeerde, B. W. Glickman, B. v. Dorp, P. Pouwels

A mutant of Escherichia coli K12 deficient in the 5'-3' exonucleolytic activity of DNA polymerase I. II. Purification and properties. *Mol. Gen. Genetics*, 124, 83, 1973

E. A. de Weerd-Kastelein, W. J. Kleijer, M. L. Sluyter and W. Keijzer

Repair replication in heterokaryons derived from different repair-deficient Xeroderma pigmentosum strains. *Mutation Res.* 19, 237, 1973

W. J. Kleijer, E. A. de Weerd-Kastelein, P. H. M. Lohman and D. Bootsma

Repair of UV-damaged DNA in normal human and Xeroderma pigmentosum cells. *Studia Biophysica, Berlin*, 36/37, 375, 1973

W. J. Kleijer

Defective DNA repair in the human skin disease Xeroderma pigmentosum. Thesis, Rotterdam, 1973

B. W. Glickman, C. A. van Sluis, G. van der Maas and A. Rörsch

Comparison of the resA1 and polA1 mutations in isogenic strains of Escherichia coli K12. *J. Bacteriol.* 114, 951, 1973

B. W. Glickman

The role of DNA polymerase I in the repair of ultraviolet light induced damage in Escherichia coli. Thesis, Leiden, 1973

W.Burgerhout, H. van Someren and D. Bootsma
Cytological mapping of the genes assigned to the human A1 chromosome
by use of radiation-induced chromosome breakage in a human-Chinese
hamster hybrid cell line.
Humangenetik, 20, 159, 1973

A. Rürsch
The biochemical approach.
Current topics in radiation research quarterly, 2, 7, 1973

G.P. van der Schans, J.F. Bleichrodt and Joh. Blok
Contribution of various types of damage to inactivation of a
biologically active double-stranded circular DNA by gamma irradiation.
Int.J.Rad.Biol., 23, 133, 1973

J.F. Bleichrodt and W.S.D. Verheij
Reversion of cistron A amber mutants of bacteriophage ϕ X174 by
ionizing radiation.
Mutation Res. 18, 363, 1973

J.J. van Hemmen, W.J.A. Meuling and J.F. Bleichrodt
Influence of the radiosensitizers parnitroacetophenone and tri-
acetoneamine-N-Oxyl on the effects of ionizing radiation on DNA.
Int.J.Rad.Biol. 24, 569, 1973

J.J. van Hemmen and W.J.A. Meuling
Sensitization and protection in the radiation chemistry of
biologically active DNA.
Current topics in Radiation Research (in press)

J.J. van Hemmen, W.J.A. Meuling, G.P. van der Schans and J.F. Bleichrodt
On the mechanism of sensitization of living cells towards ionizing
radiation by oxygen and other sensitizers.
Int.J.Rad.Biol. (in press)

G.P. van der Schans and J. de Jong
Effecten van ioniserende straling op desoxyribonucleïnezuur.
Natuur en Techniek, 41, nr.5, p.3, 1973

G.P. van der Schans and F. Campagnari
Distribution of molecular weight and sedimentation coefficient in
zonal centrifugation of DNA samples with molecules of random chain
length.
Biochemistry, 12, 1187, 1973

B.W. Glickman
The role of DNA polymerase I in the excision of pyrimidine dimers and
repair replication in E. coli following UV-irradiation.
Biochim. Biophys. Acta (in press)

Contractor : Department of Radiation Genetics and Chemical Mutagenesis

Contract No. : 102-72-a-1 BIAN

Head of research team : Prof. Dr. F. H. Sobels

General subject of Contract : The Effects of Radiation on Genetic and Biochemical Systems

Research with Drosophila melanogaster has been primarily concerned with radiation induced changes at the chromosomal level with emphasis on the analysis of repair systems in females and the mechanism of non-disjunction.

The translocation frequency produced by irradiating adult males was reduced when matings were to unirradiated females treated with caffeine, whereas an increase in dominant lethals and sex-chromosome loss was observed under identical experimental conditions. These results support the hypothesis that caffeine inhibits repair and misrepair in oocytes. The activation of some repair machinery in females was suggested by a significant increase in translocation frequency, but not sex-linked lethals, when treated (3,000 R) males were mated to females which had received a small (20 R) X-ray.

Experiments were initiated to determine the course of increasing radio-sensitivity from immature to mature oocytes. Preliminary evidence indicates that dominant and recessive lethals show different patterns of change. Additional data has added weight to support the conclusion that the recovery of translocations from irradiated oocytes is not effected by structural heterozygosity of the tested major autosomes.

Strong evidence has been obtained that radiation induced non-disjunction affecting one chromosome pair (X) requires the active participation of another pair (4) of chromosomes. Furthermore, non-disjunction of compound autosomes was found to be related to the behaviour of other chromosomes. Although additional experiments have re-affirmed that autosomal non-disjunction increases linearly with dose, nevertheless dose-fractionation studies suggest a sizable two-hit component is present at the highest dose.

Dose fractionation experiments applied to pupal spermatids have demonstrated that between 24 and 36 hours of pupal development cellular conditions change such that breaks no longer reconstitute but remain open until after fertilization.

Computer simulation supports the validity of an inbreeding technique used to detect the presence of autosomal lethals that has served as a basis for estimating the mouse genome mutation rate. However, the same method tested in Drosophila by model

experimentation was found to be inefficient.

Research on the origin and nature of 8-azaguanine resistant cells in diploid mammalian somatic cell culture has provided additional evidence that 8-azaguanine plays a role in the occurrence of new mutants. Analysis also showed that a large part of the resistant mutants were not stable in the absence of the drug. In human diploid skin fibroblasts the spontaneous mutation frequency to 8-azaguanine resistance was determined.

A number of experimental approaches designed to induce cell transformation by irradiation of human diploid skin fibroblasts have, as yet proven to be unsuccessful.

Following whole-body irradiation (400 R) of mice, a constant 1:4 ratio for visible aberrations in spermatocytes and bone-marrow was found after 60 and 100 days. The difference in germ cells vs. somatic cells is not thought to be based on real differences in induction frequencies, but rather on differences in elimination and/or clonal proliferation of aberrant stem cells after irradiation.

Using an in vitro test system with human foreskin fibroblasts, experiments have been initiated to determine whether the kind of storage effects for chemically induced genetic damage which operate in *Drosophila* can be demonstrated in a mammalian cell system.

Project No.: 1.1.1

Head of Project and scientific staff:

Prof.Dr. F.H. Sobels
D. Mendelson

Title: Effect of changing the maternal genotype and physiological environment of the oocytes on the repair of chromosome breaks induced in spermatozoa.

The manner in which radiation damage, induced in the male genome, is affected when the females (to which the irradiated males were mated) are treated with caffeine was examined. The rationale for this kind of experiment is derived from the following observations:

- 1) Breaks induced in mature sperm stay open until shortly after fertilization, when they are repaired (or misrepaired) by a special repair machinery that exists in the oocytes (Muller 1940, Leigh and Sobels 1970, Würgler 1971).
- 2) The magnitude of the genetic damage measured after irradiation of sperm is subject to modifications by the genotype of the females (Würgler and Maier 1972), and the physiological environment of the oocytes (Proust et al. 1972)
- 3) Caffeine acts in several organisms as an inhibitor of repair of damage induced by various physical and chemical mutagens.

Three types of end points were scored in the series of experiments reported here: dominant lethals, sex chromosome loss, and two kinds of chromosomal rearrangements; translocations and transvections (Lewis 1954). If caffeine interferes with repair of paternal chromosome breaks in the oocytes, one would expect that treatment of females with caffeine will result in an increase in the frequencies of dominant lethals and sex chromosome loss both due to open unrestituted breaks. Furthermore, inhibition of repair will equally affect processes of misrepair which are responsible for the formation of chromosomal rearrangements. Therefore, a reduction in the frequency of rearrangements is expected. All experiments were performed according to a similar procedure: Young females of different genetic constitution, treated or not treated with caffeine (0.15% - 0.2%), were mated to mature $R(1)2,yB/B^sYy^+$ males that had been irradiated by 2000 R of X-rays. The results obtained are as follows:

- 1) A significant increase in dominant lethal frequency was observed in the paternal genome when Inscy; bw; st p^P females were used.

- 2) The rate of loss of paternal sex chromosome was increased in two of the female strains used: y sn³ and Inscy; bw; st p^P. However, in another strain Ubx e⁴/Payne ca, in which a comparatively much higher rate of radiation induced chromosome loss is observed, caffeine remained without effect.
- 3) Caffeine treatment of both Inscy; bw; st p^P and Inscy; bw; st females reduced the frequency of translocations recorded from paternal genome. In contrast, no significant effect of caffeine on the rate of rearrangements was observed, when Ubx e⁴/Payne ca strain was used for a transvection test. The increase in the rate of X-ray induced paternal dominant lethals and sex chromosome loss, and a decrease in the rate of paternal translocations, after treatment of caffeine to females, are entirely in line with the presumption that caffeine inhibits repair or misrepair in *Drosophila* oocytes. The high frequency of sex chromosome loss obtained when using Ubx females illustrates again the phenomenon of genetic control on maternal repair. However, the observation that caffeine treatment does not affect the yields of sex chromosome loss and chromosomal aberrations suggests that Ubx females have a defective repair system, the repair factor that is missing in these females might be one that in other types of females is inhibited by caffeine. At present various experiments with NaF are performed, in order to study the effect of treatment of females with NaF on the yield of X-ray induced damage in the paternal genome. In these experiments dominant lethals, sex chromosome loss, and translocations are also scored.

Project No. : 1.1.2

Head of Project and scientific staff : Dr. K. Sankaranarayanan

Title of Project : Effects of small doses of radiation to *Drosophila* females on the recovery of sex-linked recessive lethals and autosomal translocations from mature spermatozoa sampled from irradiated males

This project is an extension of the one discussed in the 1972 EURATOM report: (B.1.1: Effects of changing the maternal environment with chemical inhibitors on the repair of chromosome breaks induced in male and female germ cells). In the present study, the change in the maternal environment has been brought about using an X-ray exposure of 20 R. 7-day old Oregon males were irradiated with 3000 R and mated to 4-day old females which were either irradiated with 20 R or not at all (M-group). The frequencies of sex-linked recessive lethals and autosomal translocations induced in the mature spermatozoa were scored in the two groups. The results show that (i) the frequencies of recessive lethals are essentially the same in the two groups in spite of the fact that in one group, females had received 20 R of X-rays and (ii) in contrast, the frequencies of II-III translocations were significantly higher in the MF group where the females had received 20 R. The data on which these conclusions are based are the following:

sex-linked lethals	Group M	10.4% (425 lethals in 4071 X-chromosomes tested)
	Group MF	10.8% (469 lethals in 4359 chromosomes tested)
II-III translocations	Group M	9.5% (218 translocations in 2188 tested gametes)
	Group MF	12.5% (257 translocations in 2056 tested gametes)

The tentative hypothesis that is suggested to explain the above results is that small doses of irradiation to the females presumably activates some repair machinery which facilitates misrepair (generating translocations) as well as repair (restitution). The consequence of this would be that at least some broken chromosomes, which would otherwise have been eliminated via dominant lethality have now taken

part in the formation of translocations. The frequency of dominant lethals in the M group would then be expected to be higher than in the MF group and the limited data available suggest such a trend. Experiments are continuing.

Results of Project No. : 1.2 (new)

Head of Project and scientific staff : Dr. P.A. Roberts

Title of Project : A study on whether transmissible terminal deletions can be recovered in *Drosophila*

A key parameter in the recovery of chromosomes broken by irradiation is the stability of a segment that has lost the terminal piece or telomere. Although H.J. Muller has presented evidence that only ring chromosomes or rods capped with preexisting telomeres are stable, reports of chromosomes with terminal deficiencies that have, presumably, become stable in animals as well as plants have appeared repeatedly in the literature. A quantitative cytogenetic approach had never been attempted and promised to answer this question, so we decided to determine the frequency of recovery of such rearrangements by examining the offspring of X-rayed (4000 R) wild-type males mated to females bearing mutant yellow and achaete alleles at the tip of the X. Six double mutants were recovered out of 93,000 F₁ females examined. Three of these proved to be sterile. Of the remainder, two carried interstitial deficiencies of the tip of the X. Thus the frequency of rearrangements that, in all probability, mimic terminal deletions (i.e., a telomere from a non-polytene region such as 4L or XR capping the deleted XL would be almost impossible to detect) was only one in 93,000 irradiated X chromosomes. It is apparent from these data that the probability of "healing" of a broken chromosome end in *Drosophila melanogaster* is vanishingly small.

In the course of this study to determine whether stable terminal deletions of the X chromosome can be recovered, a collection of mutations of yellow, a gene near the tip of the X, was analyzed. Half of the yellow mutations induced by exposure of sperm and spermatids to 4000 R of X-rays were associated with rearrangements detectable in polytene chromosomes. A number of exceptions to the rule that male viable, fertile and non-variegating mutants are unlikely to have grossly rearranged X chromosomes were found. The use of translocation and inversion breakpoints to localize genes may lead to errors unless caution is exercised because rearrangements independent of the specific locus are not uncommon.

Project No. : 1.3

Head of Project and scientific staff :

Dr. K. Sankaranarayanan

Title of Project : Effects of structural heterozygosity on the induction of autosomal translocations in female germ cell stages

The induction of translocations between chromosomes II and III was studied in oocyte stage 14 and 7 from females that were structurally heterozygous for these chromosomes ($\frac{SM5}{+}; \frac{TM3\ Sb\ Ser}{+}$). The general rationale of the experiment is the following: exchanges between chromosomes in stage 7 oocytes depend on pairing relationships whereas in stage 14 oocytes, on chance associations; if homologous chromosomes can be effectively inhibited from pairing for exchange, the chromosomes so inhibited undergo distributive pairing, which is dictated by chromosome length and not by homology. In a structural heterozygote such as the one used (the SM5 and TM3 chromosomes are believed to inhibit exchange pairing), there is thus a greater opportunity for heterologous pairing. If translocations can be induced between the autosomes and provided there are no complications in segregation following their induction, such translocations should be recoverable at higher frequencies from structurally heterozygous females than from normal females.

The results show that (i) in stage 14 oocytes irradiated with 500 R, out of 1750 gametes tested, 9 translocations were recovered (0.51%); (ii) in stage 7 oocytes irradiated with 3000 R, the rate of recovery is quite low ... 6 in 3112 gametes tested (0.19%) and (iii) the translocations could not be kept for more than a generation or two following their recovery.

The frequencies of translocations recorded in the two germ cell stages are not statistically significantly different from those recorded by Traut in experiments where structurally normal females were employed (0.36% in stage 14; 500 R irradiation; 0.32% in stage 7, 3000 R irradiation). The results thus demonstrate that structural heterozygosity does not have any appreciable effect on the rate of recovery of autosomal translocations from either of the germ cell stages examined in this respect.

Project No. : 1.5

Head of Project and scientific staff : Prof. Dr. F.H. Sobels

Title of Project : Repair of chromosome breaks in spermatids

In a preceding report (1972, p 201) it has been pointed out that following irradiation of 24-hr pupae, breaks rejoined before the formation of mature spermatozoa in 3 out of 4 experiments, but remained open in a fourth experiment. To determine more precisely at what time during spermatogenesis the transition from additivity to interaction of breaks (as measured by dose fractionation experiments) occurs, a somewhat different set of fractionation experiments was carried out, using 24-hr and 36-hr pupae. For collecting the pupae special precautions were taken that cultures with carefully controlled population density were used, because Fritz Niggli (1966) had demonstrated that when pupation is delayed, in consequence of overcrowding, development of the testes proceeds autonomously. The fractionation schedule was as follows: A) One group of pupae received a total dose of 800 R split into two fractions of 400 R given at 24 hours and 32 hours B) A second group of pupae received a single dose of 400 R at 24 hours, and a third group of pupae received a single dose of 400 R at 32 hours. Thus the translocation frequency from the pupae which had received 800 R split into two fractions given 8-9 hours apart was compared with the sum of the translocation frequencies from the pupae which had received single doses of 400 R at 24 hours or 32 hours. A similar procedure was followed in another experiment where the initial treatment was given to 36-hr pupae.

It was found then that the translocation yield with fractionated exposures was exactly the sum of that recorded for the two single exposures when the first exposure was given to 24-hr pupae. However, when the first exposure was given to 36-hr pupae, the yield in the fractionated group far exceeded additivity of yields in the two single exposure groups. This result indicates that breaks from the first fraction, given at 36 hours, remained available for interaction with those produced at 45 hours. In summary, it is clear that the cellular conditions responsible for restitution of breaks in pupal spermatids drastically change from 24-hr to 36-hr pupae.

Another interesting result from this experiment is revealed by some hitherto unknown changes of radiosensitivity to the induction of translocations, in that sensitivity is highest in 24-hr pupae, 400 R producing 5.6% translocations in 1908 gametes, and this decreases to 2.9% translocations in 1775 gametes in 36-hr pupae. In the one exceptional experiment (referred to above), where interaction of breaks was observed after irradiation of 24-hr pupae, the yield was equal to that found in older (45-hr) pupae; this suggests that in this particular experiment the testis was advanced in development, and that emphasizes the need to carefully control population density in experiments of this kind.

Project No.: 1.7

Head of Project and scientific staff:

Dr. K. Sankaranarayanan

Title of Project: How are the marked sensitivity changes from immature (stage 7) to mature (stage 14) oocytes brought about?

Most of the work on female cell stages has thus far been performed on only two stages designated as stages 7 and 14 (stage 7 cells are the oldest oocytes in newly-emerged females whereas females aged two or more days have one stage 14 oocyte in each ovariole); these two stages differ markedly in their genetic radiosensitivity, the magnitude of the difference being dependent on the criterion used to assess the difference. Practically nothing is known about the spectrum of radiosensitivity and repair potentials of the stages between 7 and 14. A series of experiments were therefore initiated to study this problem.

Oregon-K females of different ages ranging from 4 hrs to 36 hrs after eclosion were irradiated with 3000 R of X-rays and the induction of dominant lethality in the eggs stages sampled during one overnight egg-laying period (representing the most advanced stages at the time of irradiation) was studied. In a second set of experiments, females of ages 4 hrs and 24 hrs were irradiated with 3000 R or 500 R and the induction of second chromosome recessive lethals was studied, again, in those germ cell stages that were most mature at the time of irradiation (overnight sampling). In all these experiments the 4-hr group (advanced oocytes stage: 7) served as a basis for comparison.

The results available thus far show that (i) the oocytes sampled from females of age 4 hrs, 8 hrs and 12 hrs show similar sensitivity to the induction of dominant lethals; (ii) the sensitivity shows a gradual increase with increasing age of the females up to about 18 hrs after which the increase is more steep; by about 28 hrs of age, the frequency of dominant lethals is 1.7 times that observed in the 4-12 hr group (85%, 50%), (iii) from about 28 hrs of age onwards, the increase is more gradual; (iv) in contrast, the frequency of second chromosome recessive lethals in oocytes sampled from 4 hr-old and 24 hr-old females are nearly the same (about 9% with 3000 R and about 2.8% after 500 R).

It thus appears that with increasing age of the females, the change in sensitivity of the oocytes to the induction of dominant lethals is more marked than that for recessive lethals. The experiments are continuing.

Project No.: 11.1

Head of Project and scientific staff:

Prof. Dr. F. H. Sobels
Prof. D. R. Parker
Dr. B. Leigh

Title of Project: Studies on the induction of non-disjunction. I (Prof. Dr. F. H. Sobels)

For the study of induced non-disjunction in stage-7 oocytes, compound second chromosomes were used, according to the method of Clark and Sobels (Mutation Res. 18 (1973), 47-61). The following factors were considered: (1) The effect of fractionation of X-ray exposure; (2) The dose effect relationship in the low-dose range; (3) The effect of EMS (ethylmethane sulphonate). Only findings for disomics will be considered, because disomic eggs can arise only by non-disjunction, while nullosomics may originate from both non-disjunction and chromosome loss, following breakage.

(1) Dose fractionation

Earlier observations (Clark and Sobels 1973) had shown that the induction of non-disjunction increases linearly with radiation exposure over a range of 250-3000 R, and thus seems to reflect a single-hit event. This finding, however, is not in line with the idea of Parker and co-workers, that interchange plays a causative part in the production of non-disjunction by irradiation in the immature oocytes. A study on the effect of dose fractionation, therefore, seemed of interest to test whether two-hit effects can indeed be ruled out. Thus exposures of 1000, 2000 or 3000 R were given either single or split into two fractions separated by three hours. It was observed that fractionation of an exposure of 3000 R leads to a highly significant decrease in the frequency of disomic eggs, whereas fractionation of exposures of 1000 and 2000 R remains without effect. The reduction in yield with fractionation of 3000 R suggests a sizable two-hit component. This is surprising in view of the linear increase with dose over a range from 1000-3000 R found both in these and the earlier experiments with Clark.

(2) The dose effect relationship in the low-dose range

The earlier data on the dose effect relationship were collected from experiments in which the different exposures were given at different times. In view of

the importance of defining more precisely the dose-frequency relationship for non-disjunction in the low dose range, further data were collected from experiments in which flies from the same sample were used for controls and exposures to 125, 250, and 500 R. The results show a highly significant increase in the frequency of non-disjunction from 0-125 R, and thus do not at all support a threshold effect. However, from 125-1000 R, the frequency of non-disjunction remains the same. This peculiar saturation effect in the exposure range from 125-1000 R, which is reminiscent of Traut's step-wise curves, suggests that there is no simple 1:1 or 2:1 relationship between the initiating event and the occurrence of non-disjunction. It is known that various events which result in enlarging the distributive pairing pool, increase the chance that compounds segregate as disomics. It is assumed then that this enlargement of the distributive pool can be brought about in a number of different ways, which may all lead to a common end result: disomic segregation.

(3) The effect of ethylmethane sulphonate

A large number of experiments were carried out with 0.025 mol EMS, administered by adult feeding. No increase over the control value of non-disjunction was observed, however, in a total of 40,880 tested eggs. To test whether the concentration of EMS used would be genetically effective, a test for recessive sex-linked lethals was carried out, and then a frequency of 25% lethals was obtained. Since it is known that EMS likewise fails to induce detachments of attached X-chromosomes (half-translocations) in stage-7 oocytes, the negative findings on non-disjunction possibly form another indication that chromosomal interchange may be involved in the induction of non-disjunction. For a further investigation of this question experiments have now been started in which both detachment of attached X-chromosomes and the induction of non-disjunction for the fourth chromosome can be studied.

Project No. : II.2

Head of Project and scientific staff : Prof. D.R. Parker

Title of Project : Studies on the induction of non-disjunction. 2

Over the past several years, it has been found that the effects of radiations on segregation in Drosophila melanogaster frequently (nonrandomly frequently) are expressed on two different chromosome pairs, simultaneously. Gametes that are disomic for one kind of chromosome frequently are nullisomic for another: eggs having two X-chromosomes are frequently nullo-4, and nullo-X eggs are frequently diplo-4.

One can imagine two ways this can be brought about. The effect might primarily be upon one pair of chromosomes, causing nondisjunction; this might, in some way (e.g., nonhomologous pairing), secondarily bring about the misbehaviour of another, nonhomologous, chromosome pair. Another possibility is that the misbehaviour of either of these chromosome pairs required the participation of both. Evidence has been accumulating to support the latter type of interpretation (without excluding the possibility that the former could likewise be operative). A non-randomly high rate of structural change, of a type expected from interchange between the nonhomologous chromosomes, as well as other kinds of evidence, indicated that much of the segregational error comes about as a result of abnormal conjunctions resulting from chromatid interchange. The chromosomes that have been most extensively studied in this respect are the X- and fourth-chromosomes.

A critical test of this hypothesis was made in the following way. If much of the radiation-induced nondisjunction of these two acrocentric chromosomes results from interchange between them, the resulting conjunctions bringing about improper orientations on the division I spindle, then the fusion of these two chromosomes (Robertsonian translocation) into a single, sub-metacentric chromosome should have a drastic effect in reducing the incidence of radiation-induced trisomy. Accordingly, stocks were constructed in which the females to be irradiated had only the fused X.4 chromosomes. Stringent precautions were necessary to assure that these females did not have either Y-chromosomes or free fourth-chromosomes, as either of these would have caused a high "background noise" of spontaneous,

secondary non-disjunction that would have made it more difficult to measure the effects that could be ascribed to the treatment. Crosses were constructed in such a way that inviability due to chromosomal imbalance could be avoided, and comparisons were made between females having the fused chromosomes and those having free X- and fourth-chromosomes, these being the X and 4 from which the Robertsonian translocation had been made.

A six-fold reduction in the incidence of XXY females was found to result when X.4/X.4 females were compared to X/X; 4/4 females. As expected from interchange, the former gave a much higher incidence of new compound chromosomes, both compound X and compound 4, than did the latter. Interchanges occurred, but the consequences of interchange depended on the structure of the elements involved in the interchange. These experiments constitute the strongest evidence to date that radiation-induced non-disjunction (trisomy) affecting one chromosome pair requires the active participation of another pair of chromosomes: Radiation effects on segregation are not exercised on single bivalents.

Project No. : II.3

Head of Project and scientific staff : Dr. B. Leigh

Title of Project : Studies on the induction of non-disjunction. 3

Young females of the genetic constitution X,y B; C(2L),j; C(2R),px were given an exposure of 1500 R X-irradiation. They were then mated to males carrying compound second chromosomes and allowed to lay eggs for 5 days. The progeny were scored for X- and second chromosome non-disjunction and loss. There was an interaction between the two types of chromosomes. Half of the nullo-X gametes were diplo-2. The complementary class, diplo-X nullo-2 gametes, were very rare. The interpretation of these data is that any radiation induced change, which affects the pairing of normal chromosomes, has a high probability of inducing non-disjunction of distributively paired compound chromosomes.

In the course of these experiments, it was observed that when males carry the C(2R), cn no maternal second chromosome gains or losses are recovered. Cytological examination of primary spermatocyte division figures showed regular segregation of the compound autosomes in such males, but random segregation in males with another C(2R). This was further tested by mating both of these types of male to females which were XXY and carried compound second chromosomes. This test confirmed that C(2R), cn segregates regularly from C(2L)'s.

Project No. : III.1

Head of Project and scientific staff : Dr. A. Schalet

Title of Project : Quantitative and qualitative characterization of radiation-induced breakpoints in the proximal heterochromatic and adjacent euchromatic regions of the X chromosome

Earlier notions concerning the relative frequency of radiation induced chromosome breakage in euchromatic and heterochromatic regions, radiation induced deficiencies in and bordering on heterochromatic regions, i.e. the minute rearrangements of Muller, and the distribution of radiation induced breakpoints within heterochromatic regions, have to be revised in the light of recent knowledge concerning the true nature of heterochromatic regions in mitotic and salivary gland chromosomes (Schalet and Lefevre, 1973; Schalet and Lefevre, in press).

In order to obtain an estimate of rearrangement frequency within heterochromatic segments of different size, the markers ac (distal) and su(f) (proximal) have been used to delimit the heterochromatic regions of two special X chromosomes, sc^{S1}-sc⁸ and sc⁴-sc⁸. These chromosomes have an approximately 6-fold difference in their heterochromatic content. Genetically proven deficiencies for either marker, but not both simultaneously, must have a breakpoint within the delimited heterochromatic region.

Following the irradiation of adult males with 3.000 R, the relative frequency of induced deficiencies in each chromosome was approximately proportional to their heterochromatic content. However, the frequency of ac appearing mutants in the sc^{S1}-sc⁸ chromosome was only about 1.5 times the frequency of ac appearing mutants in the sc⁴-sc⁸ chromosome. This result compares with Muller's finding that such mutants occurred in sensibly the same frequency in a comparable experiment. Genetic analysis of ac mutants in the sc^{S1}-sc⁸ chromosome shows that the vast majority are deficiencies, a result which has been reported previously. In contrast, the majority of ac mutants induced in the sc⁴-sc⁸ have proven to be non-deficient position-effect rearrangements of a type which could not have been detected in the sc^{S1}-sc⁸ chromosome under the conditions of our experiment.

Although earlier work has shown that deficiencies of the type detected here in the $\underline{sc}^{S1} - \underline{sc}^8$ chromosome show a linear frequency-dose relationship, they can not be the very minute rearrangements in the sense that Muller believed because of a misconception concerning the nature of the heterochromatic region in mitotic and salivary gland chromosomes. Consequently, the analysis is being continued in order to try to obtain further evidence concerning their true nature.

Project No. : III.2

Head of Project and scientific staff : Dr. B. Leigh

Title of Project : Studies of the effects of different gases, during or after irradiation,
on a ring X-chromosome

In a preliminary set of 4 experiments, R(1)2, v f ring X-chromosome bearing males were given an exposure of 3000 R in air. Irradiated spermatozoa were sampled by mating the treated males to ln(1)dl-49, y ac v f mal¹ su-f females. The F₁ progeny were scored for large and small deficiencies; the former being recovered as hemizygous males with fragments carrying the wild type alleles of one or more of the maternal X-chromosome markers, the latter being recovered as females hemizygous for one or more of the same markers.

The F₁ contained 7800 normal female progeny and 75 gynandromorphs. There were also 13 hyperploid males and 16 females scored as deficiencies. Most of the identifications were based on the phenotype of the F₁. The frequencies of exceptions, 0.2% and 0.16% respectively, are too low to be useful for a study of the effects of radiation exposure given in different gases.

It is worth noting that there was only one small deficiency of y⁺ and ac⁺, while 8 of the F₁ females showed the phenotype associated with a deficiency for su-f. On the other hand, 6 of the hyperploid males carried a piece of chromosome with the markers y⁺ ac⁺. An attempt is now being made to construct a C(1)RA, y ac v f mal¹ su-f bb⁺ chromosome. This will be useful for the recovery and testing of fragments from the R(1)2, v f ring, since the fragments will be detected in hyperploid F₁ fertile females at a higher rate than fragments recovered in F₁ males and it should be possible to investigate the effect of different gasses on breakage of specific regions of the ring X-chromosome.

Project No. : V

Head of Project and scientific staff : Dr K. Sankaranarayanan

Title of Project : How valid are the genome mutation rate estimates in the mouse?
A reconstruction experiment with *Drosophila*.

The efficiency of the technique of inbreeding (which mouse workers employ to screen for the presence of autosomal recessive lethals) has been examined using two approaches: computer simulation and model experimentation with *Drosophila*. The points taken into consideration are the following: (i) when there is mating between two heterozygotes carrying the same autosomal recessive lethal, 25% of the resulting progeny will die due to homozygosity for the recessive lethal; (ii) when one of the parents is heterozygous for an autosomal recessive lethal and the other heterozygous for the same recessive lethal (with a probability of 0.5) or not carrying the recessive lethal (also with a probability of 0.5), the expected mean reduction in survival in the resulting progeny (relative to the controls in which none of the parents carry a lethal) is 12.5%; (iii) when there is mating between individuals that do not carry lethals (controls) the survival should ideally be 100%; (iv) when a large number of crosses of types (i) to (iii) are made, the observed distribution of survivals around the respective means could be plotted and compared with theoretical expectations. The question asked is: what is the degree of precision with which one can assign a survival value in a given cross as belonging to type (i) or (ii) or (iii)? The computer simulation shows that (a) when samples of 100 eggs are repeatedly drawn from an imaginary population and distributions of their survival plotted when the control mean survival is 92% (the level actually observed in mouse studies) and when the expected mean survival in type (i) crosses is 69% (i.e. 75% of 92%), these two distributions do not overlap; if instead the expected mean survival is 80.5% (type (ii) crosses) and the control survival as before, the distributions overlap slightly such that the efficiency of identifying a "lethal cross" (i.e. $+1 \times +1$) is still high and is not inconsistent with what Luning has claimed (60-65% efficiency of detection) with somewhat smaller sample sizes.

For the *Drosophila* experiments, the material was derived from a radiation experiment and consisted of flies which (a) were heterozygous for a lethal in their second chromosomes and (b) which did not carry lethals in their second chromosomes. (The reason for choosing the above kind of flies from a radiation experiment was that these had similar backgrounds and the two groups differed from one another by the presence or absence of a lethal).

The following kinds of crosses were made:

"F ₁ crosses":	+/1 x +/1	(122)	(1)
	+/N x +/N	(122)	(2)
"F ₂ crosses":	+/1 x +/1 or		
	+/N	(121)	(3)
	+/N x +/N	(108)	(4)

(N denotes lethal free chromosome)

Hatchability of the eggs and egg-adult survival were measured in the different crosses; for the latter, the number of eggs laid by individual females was restricted to 10 per female and for any one lethal not more than 120 and not less than 50.

The main conclusions that follow from this study are (a) homozygotes for recessive lethals do not die in the egg stage; (b) the mean egg adult survival is 55%; in the +/1 x +/1 or +/N crosses it is about 66%; (c) the distribution of survivals around the mean values in the last two crosses shows overlap with that of the controls. It appears that the overlap is indeed expected under the above conditions where the absolute mean survivals are lower than in the mouse. Because of this overlap, the efficiency of the technique of inbreeding to score for autosomal recessive lethals in *Drosophila* is low. In the mouse, however, where the overlap is not very much, the technique is adequate and has an efficiency of over 60%, which LÜning claims.

Ref: LÜning, K.G. Testing for recessive lethals in mice. *Mutation Res.* 11 (1971), 125-132.

Project No. : 1

Head of Project and scientific staff : Dr. J.W.I.M. Simons,
Dr. A.A. van Zeeland
Drs. A.G.A.C. Knaap

Title of Project : Mutation in diploid somatic cells in vitro

a) Research was continued on the question whether the selection systems used for the determination of mutation frequencies in somatic cells in vitro fulfil the requirements for mutation studies.

An additional experiment for the determination of mutant frequencies at two concentrations 8-azaguanine confirmed earlier results that these frequencies are about the same, while these mutants differ in the amount of residual enzyme activity. These data are not in agreement with the notion that 8-azaguanine acts only as a selective agent. Furthermore it was shown that mutations can be induced in diploid and tetraploid V79 Chinese hamster cells with about the same frequency which contradicts the notion that these mutants are recessive. Further research is directed to the question whether the tetraploid mutants still contain two functionally active X-chromosomes. The evidence so far obtained points in this direction.

b) Experiments are also carried out with human diploid skin fibroblasts for the determination of spontaneous mutation frequency. The results show an incidence of 1.56×10^{-6} per cell generation.

c) HGPRT-deficient mutants were obtained from near diploid L5178Y mouse lymphoma cells. The selection system does not yet give reproducible results.

Project No. : 2

Head of Project and scientific staff : Dr. J.W.I.M. Simons,
Dr. A.A van Zeeland,
Drs. Y.C.E.M. de Ruyter

Title of Project : Analysis of 8-azaguanine resistant mutants

a) Mutants selected from diploid human skin fibroblasts were tested for their stability in the presence or absence of 8-azaguanine over a period of 30-50 days. A part of the mutants with residual enzyme activity proved to be very unstable, increasing 7-40 fold in HGPRT-activity. To investigate whether this could be due to the presence of wild type cells amongst the mutant cells, mutant cell populations were tested for heterogeneity by seeding them for cloning in the presence or absence of AG, followed by treatment of the developing clones with HAT medium. In this way it could be shown that cells which gave rise to HGPRT-deficient clones in medium with AG could give rise to HGPRT-containing clones in medium without AG. Therefore, it is concluded that a large part of the mutants needs the presence of the selective agent to maintain their mutant character and thus cannot have originated by true mutation.

b) Hybridization experiments were started. So far no evidence has been obtained for complementation between different mutants isolated in vitro or between such mutants and Lesch Nyhan cells.

Project No. : 3

Head of Project and scientific staff : Drs. P.P.W. van Buul

Title of Project : Comparative studies on the induction of chromosome aberrations
in somatic cells and spermatogonia of mouse and monkey

The ratio 1 to 4 previously reported for visible translocations present in spermatogonia (scored in spermatocytes) and in bone-marrow cells of the mouse 60 days after irradiation with a dose of 400 rad, was also observed when translocations were scored at 100 days after irradiation with the same dose. This suggests that at least in certain circumstances the ratio between chromosome aberrations in the testes and in the bone-marrow can be a constant one over a rather long period. The striking difference in translocation frequency found between bone-marrow cells and spermatogonia makes it likely that elimination and clonal proliferation of aberration carrying stem cells plays an important role in determining the ratio between chromosome aberrations in both tissues. Probably these mechanisms are tissue-specific.

Since for the extrapolation to man especially the situation in the peripheral blood is most important, the work on the dose-response curve of radiation-induced stable chromosome aberrations in the bone-marrow and testes of the mouse has been temporarily put aside until more information has been obtained on the correlation between aberrations observed in peripheral blood and bone-marrow. More attention has been given to a new kind of dose-rate experiment, in which 3 groups of mice have been irradiated with dose rates of 130, 1.92 and 0.0278 rad γ -rays per minute. The total dose was in all cases 400 rad. The results show that the ratio between translocations in the bone-marrow and in the testes is not affected by dose-rate in the tested area.

Initial results obtained from irradiated testis material of the rhesus monkey show that the frequency of visible translocations induced in spermatogonia and scored as multi valents in spermatocytes is very low. In more than 1500 cells from a monkey irradiated with a dose of 100 rad, only one possible reciprocal translocation could be demonstrated. The other doses of 200 and

300 rad also display very low translocation frequencies. The rest of the testis material and the bone-marrow and peripheral blood samples are now under investigation to get more information about the "somatic-germ cell" correlation in the rhesus monkey.

The dose fractionation experiment performed in cooperation with Dr. A. Léonard of Mol, has been finished. It turned out that fractionating a dose in unequal portions has a clear effect on the translocation frequency in spermatogonia of the mouse. 100 + 500 rad X-rays delivered 24 hrs apart, gives a significantly higher translocation yield than 500 + 100 rad X-rays with the same interval between the two doses, whereas no significant differences existed between a 300 + 300 rad radiation regime and a single dose of 600 rad.

Project No. : 4

Head of Project and scientific staff : Dr. A.D. Tates

Title of Project : Are there storage effects for chemically induced genetic damage
in mammalian cells?

The research for 1973 was originally planned to be a continuation of that in 1972, i.e. the induction of genetic radiation damage in male germ cells of man and monkeys. As indicated in the annual report for 1972, the results of the in vitro experiments were rather disappointing. Therefore it was decided to postpone this type of experiments until better methods, which permit differentiation of spermatogonia into dividing spermatocytes, become available.

In 1973, research was started to obtain experimental evidence for the existence of storage effects for genetic damage induced by chemicals in mammalian somatic cells. Such effects have been clearly demonstrated in spermatozoa of *Drosophila melanogaster* after treatment with polyfunctional and monofunctional alkylating agents. When chemically treated *Drosophila* spermatozoa are stored in untreated females, the frequency of chromosomal aberrations is significantly higher in stored spermatozoa as compared to unstored spermatozoa. Monofunctional compounds require a larger storage time to manifest an increase in aberration frequency.

Polyfunctional and monofunctional alkylating agents are frequently used for chemotherapeutic treatment of cancer patients and it has been found that the polyfunctional agents are more effective than monofunctional ones. The relatively greater effectiveness of polyfunctional agents may be due to storage effects in man.

Although several pilot experiments have been carried out to test the feasibility of using two in vivo test systems to detect storage effects, the main emphasis has been on an in vitro test system with human foreskin fibroblasts. The latter cells are seeded in Petri-dishes containing F10 medium with 15% newborn calf serum. When the cells have become confluent this medium is replaced by F10 plus 1% serum ("storage medium"). This procedure results in the formation of a "spermatozoa-like" population of cells that can remain in a "dormant state" or stationary phase for a period of at least two weeks. When cells have reached the

stationary phase they are treated for 24 hours with TEB (2,3,5,6-tetra-ethyleneimino-p-benzoquinone), which is extremely effective in producing chromosome aberrations in human leukocytes in vitro. The treatment with the mutagen is followed by frequent washing with storage medium. After washing the cells of one half of the Petri dishes (US = unstored cells) are trypsinized, seeded in normal medium and allowed to grow for 70 hrs. Following the growth period, cells are treated with Colcemid and other agents necessary for making chromosome preparations. The rest of the Petri dishes (S = stored cells) remain - after washing - for one week on the storage medium and are then treated in the same way as the US cells. Evidence for the presence or absence of storage effects in the treated foreskin fibroblasts is obtained by comparing frequencies of chromosome aberrations in US and S cells. The preliminary results of one storage experiment are presented in the Table. Although more cells will be analyzed from this experiment it seems already quite evident that the induction of aberrations, let alone storage effects, cannot be detected under the experimental conditions thus far applied. The absence of induced chromosome aberrations cannot be due to the applied concentrations of TEB, because at higher concentrations of TEB it is impossible to obtain chromosome preparations. Whether other factors such as the stage of the cell cycle during TEB treatment, or time of fixation of the treated cells, play a role will be explored in future experiments.

TEB ug/ml. medium	Group of cells	Number of normal cells	Number of cells with:		
			Chromatid	isochromatid gaps, breaks or fragments	Dicentrics
0.0005 -	US	99	0	0	2
	S	90	1	2	1
0.00025 -	US	100	0	0	0
	S	102	1	1	1
0.00013 -	US	119	1	3	1
	S	101	0	0	0
Control	US	99	0	2	1
	S	99	2	0	0

Project No. : 5

Head of Project and scientific staff : Dr. J.W.I.M. Simons

Title of Project : Induction of cell transformation in vitro by X-rays

a) Test on the induction of loss of contact inhibition in clones of diploid human skin fibroblasts after irradiation.

For this purpose cells were irradiated with 1200 R and seeded for cloning after seven days. Clones with loss in contact inhibition were found. Upon isolation and recloning some of these clones retained their abnormal morphological character but the cloning efficiency was very low (about one percent) and the lines were lost because of cellular ageing. Thus induction of cell transformation has not yet been observed.

b) Test for the induction of continuous growth by irradiation of stationary senescent cells.

Irradiation of stationary senescent cells provides a selection system for transformed cells as the induction of continuous growth will lead to growth of stationary cultures. Moreover this system permits the detection of cell transformation when a long lag period is involved in the process of cell transformation. To this end 50 Petri dishes per control and irradiated group (300 R) with 4×10^5 senescent cells each were initiated. The cells were kept in culture for six months. Cell transformation did not occur.

c) Test for the induction of continuous growth by irradiation of stationary cells in soft agar.

Irradiation of human diploid skin fibroblasts in soft agar provides a selection system for transformed cells as only transformed cells will be able to form clones. Also in these experiments no evidence for cell transformation was obtained.

PUBLICATIONS

1. Buul, P.P.W. van. Comparison of frequencies of radiation-induced stable chromosomal aberrations in somatic and germ tissues of the mouse. *Mutation Res.* 20, 369-376 (1973).
2. Clark, A.M. Differential viabilities of X/O males. *D.I.S.* 49, 86 (1972).
3. Clark, A.M. Influence of the nutritional state of females on the frequency of X/O males recovered after matings with irradiated males. *D.I.S.* 49, 75 (1972).
4. Clark, A.M. and F.H. Sobels. Studies on non-disjunction of the major autosomes in *Drosophila melanogaster*. I. Methodology and rate of induction by X-rays for the compound second chromosome. *Mutation Res.* 18, 47-61 (1973).
5. Heyman-Zandstra, K. and H. van Steenis. Chromosomal changes in three cell strains of the Tasmanian rat-kangaroo, *Potorous tridactylis*, (Marsupialia). *Genetica* 44, 31-38 (1973).
6. Leigh, B. Induction of attached X-chromosomes in spermatozoa, by irradiation. *D.I.S.* 48, 107 (1972).
7. Leigh, B. X-ray induced reversion of isochromosomes in mature sperm. *D.I.S.* 48, 107 (1972).
8. Leigh, B. Disjunction and induced non-disjunction of X-chromosomes and compound autosomes in *Drosophila melanogaster*. *Genetics* 74, No. 2, part 2, s154-155 (1973).
9. Leigh, B. Ring Chromosomes and radiation induced chromosome loss. In: *Genetics and Biology of Drosophila*, E. Novitski and M. Ashburner (Eds.), Academic Press. (in press).
10. Mendelson, D. The effect of caffeine on repair systems in oocytes of *Drosophila melanogaster*. I. *Mutation Res.* (in press).
11. Mendelson, D. and F.H. Sobels. The inhibiting effect of caffeine on a maternal repair system in *Drosophila*. *Mutation Res.* 21, 194-195 (1973).
12. Mendelson, D. and F.H. Sobels. The inhibiting effect of caffeine on the maternal repair of radiation-induced chromosome breaks in *Drosophila*.

Mutation Res. (in press).

13. Nöthel, H. Investigations on radiosensitive and radioresistant populations of Drosophila melanogaster. Mutation Res. 19, 187-197 (1973).
14. Roberts, P. A. Are stable terminal deletions recoverable in Drosophila? Genetics 74, No. 2, part 2, s231 (1973).
15. Roberts, P. A. A cytogenetic analysis of X-ray induced "visible" mutations at the yellow locus of Drosophila melanogaster. Mutation Res. (in press).
16. Roberts, P. A. and E. Vogel. Problems of mutation detection in independently evolving laboratory strains. Mutation Res. 21, 297-299 (1973).
17. Sankaranarayanan, K. The relationship between structural heterozygosity, asynapsis and mutability in female Drosophila. Int. J. Rad. Biol. 23, 194-195 (1973).
18. Sankaranarayanan, K. Ionizing radiations and genetic risks. Atoomenergie en haar toepassingen, July/August, 183-188 (1973).
19. Sankaranarayanan, K. Recent advances in the evaluation of genetic risks in man from exposure to ionizing radiation. Current topics in radiation research quarterly 9, 72-79 (1973).
20. Sankaranarayanan, K. A population approach to the study of repair of genetic radiation damage in mature spermatozoa of Drosophila melanogaster. Mutation Res. (in press).
21. Sankaranarayanan, K. Ionizing radiation, genetic loads and population fitness. Archiv. für Genetik (in press).
22. Sankaranarayanan, K. Recent advances in the assessment of genetic hazards of ionizing radiation. Atomic Energy Review (in press).
23. Sankaranarayanan, K. First International Conference on Environmental Mutagens: Conference Report. Mutation Res. (in press).
24. Sankaranarayanan, K. and F. H. Sobels. Radiation genetics. In: Genetics and biology of Drosophila, E. Novitski and M. Ashburner (Eds.), Academic Press (in press).
25. Schalet, A. Crossing over in the major heterochromatic region of the X-chromosome in normal and inverted sequences. D.I.S. 48, 111-113. (1972).
26. Schalet, A. Lethal, semilethal and sterile mutants in the proximal region of the X-chromosome of Drosophila melanogaster. D.I.S. 49, 64-66 (1972).

27. Schalet, A. Evidence that some spontaneously formed attached X-chromosomes in Drosophila melanogaster may originate from bb locus exchanges. *Genetics* 74, No. 2, part 2, s242-243 (1973).
28. Schalet, A. and G. Lefevre, Jr. The localization of "ordinary" sex-linked genes in Section 20 of the polytene X-chromosome of Drosophila melanogaster. *Chromosoma* 44, 183-202 (1973).
29. Schalet, A. and G. Lefevre, Jr. The proximal region of the X-chromosome. In: *Genetics and Biology of Drosophila*, E. Novitski and M. Ashburner (Eds.), Academic Press (in press).
30. Simons, J.W.I.M., A.A. van Zeeland and M.C.E. van Diggelen. Selection of hypoxanthine-guanine-phosphoribosyl-transferase (HGPRT)-deficient mutants from diploid human cells at two concentrations of 8-azaguanine. *Genetics* 74, No. 2, part 2, s256 (1973).
31. Simons, J.W.I.M., A.A. van Zeeland and M.C.E. van Diggelen. The role of 8-azaguanine in the selection of hypoxanthine-guanine-phosphoribosyl-transferase (HGPRT)-deficient mutants from diploid human cells. *Mutation Res.* 21, 235-236 (1973).
32. Sobels, F.H. Chemical mutagenesis and problems involved in the evaluation of environmental mutagens. *Excerpta Medica International Congress Series* No. 288, *Toxicology: Review and Prospect*, 160-168 (1972).
33. Sobels, F.H. Some aspects of chemical mutagenesis. *Agents and Actions*, 3, No. 2, 68-72 (1973).
34. Sobels, F.H. An unexpected effect of fractionation of radiation-dose on the induction of non-disjunction in Drosophila. *Genetics* 74, No. 2, part 2, 2260 (1973).
35. Sobels, F.H. The advantages of Drosophila for mutation studies. *Mutation Res.* 21, 237-238 (1973). (Full paper in press, *Mutation Res.*)
36. Sobels, F.H. A study on the possible effect of the gene segregation distorter, SD 72, on the radio-sensitivity of sperm and spermatids in Drosophila melanogaster. *D.I.S.* 48, 31 (1972).
37. Sobels, F.H. The viability of II-III translocations in homozygous condition. *D.I.S.* 48, 117 (1972).
38. Sobels, F.H. The induction of non-disjunction of compound second chromosomes

in stage-14 oocytes by X-rays. D.I.S. 49, 119 (1972).

39. Steenis, H. van. Chromosomal changes in eight cell strains of the Tasmanian rat-kangaroo, Potorous tridactylis (Marsupialia). Male and female heart fibroblasts cultured in vitro. *Genetica* 44, 110-124 (1973).
40. Steenis, H. van. Chromosomal changes in two strains of human fibroblasts cultured in vitro. *Genetica* 44, 125-138 (1973).
41. Steenis, H. van, R. Tuscany and B. Leigh. The distribution of X-ray induced chromosomal abnormalities in the rat-kangaroo (Potorous tridactylis) cells in vitro. *Mutation Res.* (in press).
42. Zeeland, A.A. van and J.W.I.M. Simons. Induction of hypoxanthine-guanine-phosphoribosyl-transferase (HGPRT)-deficient mutants in diploid and tetraploid Chinese hamster cell lines. *Mutation Res.* 21, 241 (1973).

Laboratory for Physiological Chemistry

Contract No. 102-72-a 1 BIAN

Dr. A.J. van der Eb

STUDIES ON THE MECHANISM OF TRANSFORMATION BY ONCOGENIC DNA VIRUSES.

Several experimental results suggest that only a few viral genes (perhaps 2) are involved in transformation by oncogenic DNA viruses. An understanding of the nature and mechanism of action of the products of these transformation genes is obviously of great importance for obtaining an understanding of the process of oncogenic transformation in general.

In the following report, the results are presented of attempts to isolate the segments of viral DNA which are responsible for in vitro transformation. In this way it might be possible to isolate the genes involved in transformation, so that these become available for further study.

In 1972 a new technique was developed in this laboratory to assay the infectivity of viral DNA's. Using this so called "Calcium technique", it was possible to demonstrate infectivity for human Adenovirus DNA's, which were previously found to be almost inactive using other infectivity procedures. In addition, it was found that cells could also be transformed with this technique, using not only intact Adenovirus DNA, but also fragmented DNA. This latter finding was the motive to investigate the possibility of isolating the segments of Adenovirus DNA's which are involved in transforming cells. Studies along these lines have shown that DNA fragments as small as 1/8 - 1/10 of the genome size are still capable of transformation. Experiments are in progress to locate the transforming genes and to obtain specific DNA fragments which carry the activity.

Similar studies are also being carried out with the DNA of SV₄₀ virus. So far it has been demonstrated that not only the circular SV₄₀ DNA is able to transform cells, but also linear molecules of genome size.

In addition, work is in progress to study the mechanism and the significance of integration of SV₄₀ DNA into cellular DNA. Several lines of evidence suggest that integration of SV₄₀ DNA not only occurs during transformation but also in productively infected cells. In order to obtain an understanding of the significance of this process, it will be necessary to study the function of integration in the virus-replication cycle.

Using productively infected BSC-1 cells, it was found that a small proportion of the infecting SV₄₀ DNA becomes associated with, and probably integrates into, the cellular DNA. Further work is in progress to determine whether integration is a necessary step in virus replication.

Project No. : B 1.1

Research workers: Dr. F.L. Graham, Drs. P.J. Abrahams, Dr. F.A.J. de Vries, Dr. A.J. van der Eb

Title : Isolation of transforming fragments of Adenovirus and SV₄₀ DNA.

Adenovirus 5 DNA, mechanically sheared to approximately 1/4 molecules, was found to be capable of transforming rat kidney cells in vitro with the same efficiency as the intact DNA (23×10^6 daltons). Upon further shearing, the transforming activity of the DNA disappeared when the molecular weight became smaller than $\pm 2 \times 10^6$ daltons.

In order to determine on which half of the molecule the transforming activity is located, Ad 5 DNA was sheared to half molecules and the GC-rich half was separated from the AT-rich half by HgCl₂-Cs₂SO₄ equilibrium centrifugation, as well as by Na I equilibrium centrifugation. It was shown that only the GC-rich half contained transforming activity.

In order to locate the transforming genes more accurately, Ad 5 DNA was cleaved into 3 specific fragments, using the R₁ restriction endonuclease. The unfractionated mixture of R₁ fragments had still retained its transforming potential, indicating that no essential genes had been cleaved. The R₁ fragments were fractionated by gel electrophoresis and the transforming activity of each fragment is presently being tested.

Using sheared Ad 5 DNA, it was also found that permissive hamster cells and human embryonic kidney could be transformed. The human transformed cells have retained their full permissiveness for adenovirus 5 and might be very useful to isolate deletion mutants and for complementation studies with ts mutants. The transformed hamster cells were injected into hamsters and appeared to give rise to tumors in the majority of the animals, thus showing the oncogenic potential of the cells transformed with fragments.

Although infectivity of SV₄₀ DNA can be readily demonstrated by, for instance, the DEAE-dextran technique, transformation with SV₄₀ DNA is very difficult to obtain. It was found, however, that rat cells could be easily transformed with SV₄₀ DNA, if one uses the calcium technique instead of the DEAE-dextran technique. The dose-response curve for SV₄₀ transformation is linear up to at least 5 µg DNA per 5 cm dish, and the specific activity is approx. 25 transformed colonies per µg DNA.

An investigation, similar to that with Adeno DNA, has recently been started with SV₄₀ DNA, and attempts are being made to isolate specific fragments of SV₄₀ DNA which are capable of transforming cells. It has already been shown that also linear molecules of genome size can transform rat cells. The linear molecules were obtained by incubating circular form I SV₄₀ DNA with the R₁ restriction endonuclease, which cuts SV₄₀ DNA at one specific site, and with the HPa2 restriction endonuclease, which also produces one specific break in SV₄₀ DNA (the HPa 2 linears were obtained from Prof.Dr. W. Fiers, Gent).

Project No. : B 1.2

Research workers: Dr. S.O. Warnaar, Dr. A.J. van der Eb

Title : Studies on the mechanism of integration of viral DNA
into cellular DNA.

Studies have been started recently on the mechanism of integration of viral DNA into cellular DNA, and on the significance of integration during virus replication. There are several suggestions that the DNA of SV₄₀ is integrated, and perhaps again excised, during its replication. By using radioactively labeled SV₄₀ virus and centrifugation through alkaline sucrose gradients, we have found that a small proportion of the parental DNA becomes associated with the cellular DNA. Using reconstruction experiments, it was shown that this association was not due to trapping in the viscous cellular DNA, and it appeared likely that the association was not due to breakdown and reutilization of the parental DNA. In order to facilitate further work, several conditions are being investigated which cause an increase of integration. It has been observed for Adenovirus 5 that the association of parental DNA with the cellular DNA increases when conditions are employed which favor transformation, i.e. UV-irradiation of the virus. The relation between UV-irradiation, integration, transformation and transplantability will be further investigated.

Work is also in progress to answer the question whether integration (and excision?) has a necessary, perhaps initiating, function in the infectious process. Information concerning this problem might possibly be obtained by studying the interaction of SV₄₀ with cells with a defect in crossing-over (rec(-)).

Laboratory for Physiological Chemistry

Contract No. 102-72-a 1 BIAN

Dr. A.J. van der Eb

STUDIES ON THE MECHANISM OF REPAIR OF RADIATION DAMAGE IN MAMMALIAN CELLS.

To obtain a better understanding of the mechanism of repair of radiation damage in mammalian cells, use is made of the fact that certain well characterized viral DNA's are infectious and replicate when introduced into suitable cells.

It was suggested from earlier work in this laboratory that the infectivity of single-stranded polyoma virus DNA (which was prepared from the double-stranded DNA), is much more sensitive towards UV irradiation than the double-stranded DNA when tested in normal mouse cells. This result suggests that a process similar to excision repair in bacteria is possibly operating in mouse cells. To obtain more information about the repair process of viral DNA in mammalian cells, a similar study has been started, using the DNA of SV₄₀ virus, which is very similar to polyoma DNA in structure and molecular weight. The advantage of the SV₄₀ system is that human cells can also replicate SV₄₀, so that various types of cells, obtained from patients with defects in radiation repair, can be used as host cell.

Although human cells are generally permissive for SV₄₀ replication, no plaques are produced in such cultures, so that an indirect infective center technique had to be developed.

The results obtained so far have extended and confirmed the earlier findings with polyoma DNA. In addition, the repair of SV₄₀ DNA has been studied in UV sensitive Xeroderma cells and actinic keratosis cells, and in X-ray sensitive Progeria cells. The results suggest that normal cells are capable of repairing part of the radiation damage not only in double-stranded DNA but possibly also in single-stranded DNA (in contrast to the situation in *E. coli*), and that homozygous Xeroderma cells cannot repair the UV damage in double-stranded, nor in single-stranded DNA.

Project No. : B 2

Research workers: Drs. P.J. Abrahams, Dr. A.J. van der Eb, Dr. S.O. Warnaar

Title : Studies on the mechanism of repair of radiation damage in mammalian cells.

SV₄₀ DNA was irradiated with UV light and the radiosensitivity of the infectivity was determined in various host cell types. In normal BSC-1 monkey cells a D₃₇ of $\pm 7,6 \times 10^3$ erg/mm² was found for double-stranded SV₄₀ DNA. A similar D₃₇ was observed for double-stranded DNA in normal human diploid cells (WI 38) as well as in heterozygous Xeroderma pigmentosum cells (XP 10). For single-stranded circular SV₄₀ DNA (prepared by denaturation of double-stranded DNA containing one single-stranded nick per molecule), a D₃₇ of approx. $3,4 \times 10^3$ erg/mm² was observed. As expected, single-stranded DNA is more sensitive toward UV irradiation than double-stranded DNA. In the homozygous Xeroderma cells (XP 9) a D₃₇ of approx. $1,1 \times 10^3$ erg/mm² and $7,5 \times 10^2$ erg/mm² was found for double-stranded and single-stranded DNA respectively. This result suggests that either normal cells are capable of repairing part of the radiation damage in single-stranded DNA, or that the single-stranded DNA is somehow converted to a partially double-stranded form before the repair process had started. Partial renaturation might have occurred, since the denatured DNA consists of a mixture of the complementary strands. To exclude the possibility of renaturation, the complementary strands of SV₄₀ DNA have been separated, using synthetic RNA, complementary to one of the DNA strands. The radiosensitivity of the DNA strand, complementary to the C-RNA, is now being tested. Preliminary experiments with Progeria cells (supposed to be defective in repair of X-ray damage), and of Actinic Keratose cells (increased UV-sensitivity of the patients), indicated that the survival of UV irradiated SV₄₀ DNA is much higher in these cells than in normal cells. However, if the total UV dose increases beyond 1×10^4 erg/mm², a sudden increase of the radiosensitivity is observed, which is particularly evident in Progeria cells. This effect will be investigated in more detail.

List of publications

1. A.J. van der Eb, Intermediates in Type 5 Adenovirus DNA Replication, *Virology* 51 (1973) 11.
2. F.L. Graham and A.J. van der Eb, A New Technique for the Assay of Infectivity of Human Adenovirus 5 DNA, *Virology* 52 (1973) 456.
3. F.L. Graham and A.J. van der Eb, Transformation of Rat Cells by DNA of Human Adenovirus 5, *Virology* 54 (1973) 536.
4. S.O. Warnaar and A.W. de Mol, Characterization of Two Simian Virus 40-Specific RNA Molecules from Infected BS-C-1 Cells, *J. of Virology* 12 (1973) 124.
5. F.L. Graham, G. Veldhuisen and N.M. Wilkie, Infectious Herpesvirus DNA, *Nature New Biol.* 245 (1973) 265.

Contractor: The University of Swansea

Contract No. 119-72-1

Dr. James Parry

Studies of the genetic, molecular and adaptive
properties of RAD loci in yeast.

Exposure of living cells to radiations and chemical mutagens produce a wide range of genetic effects in living cells. The effects include point mutation, recombination and changes in the number and quality of chromosomes. The yeast Saccharomyces cerevisiae provides us with a convenient organism for the study of the mechanism of the genetic consequences of induced DNA lesions and their repair.

Repair activity has been clearly implicated in the production of genetic damage and may be studied by a number of methods. One valuable technique involves the determination of the consequences of repair activity in wild type (RAD) yeast cultures compared to radiation sensitive mutants (rad). The results of such experiments have been used to help clarify the role of the individual rad genes in the cellular processes which take place between lesion induction and observable genetic change. Experiments of this type are of significantly more value in cultures temperature-sensitive for repair activity as direct comparisons may be made of genetic change under both permissive and non-permissive conditions.

Work has been initiated into the analysis of the effects of individual lesions upon the behaviour of nuclear DNA in the RAD and mutant cultures of the yeast.

Results of Project No. : 1.

Head of Project and Scientific staff: Dr. James M. Parry and
Mr. Peter J. Davies.

Title of Project: Comparative study of the genetic effects of
radiation and chemical mutagens in yeast.

Description of results:

A study has been made comparing the induction of mitotic inter-and intragenic recombination after treatment with UV light, gamma radiation and a number of chemical mutagens in yeast. The strain of yeast utilized was heteroallelic at two unlinked loci histidine-4 and tryptophan-5 and heterozygous at the adenine-2 locus. Prototrophic colonies were produced by mitotic intragenic recombination (gene conversion) within an operon and a cistron respectively. Mitotic intergenic recombination was detected by the production of adenine requiring recessive homozygous colonies.

Gene conversion frequency, calculated on the basis of prototrophs/survivor was plotted against cell survival in order to determine the relative induction of conversion after the different mutagen treatments. As shown in Figure I, conversion at the tryptophan-5 locus showed a maximum induction after UV light and a minimum induction after ethyl methane sulphonate treatment.

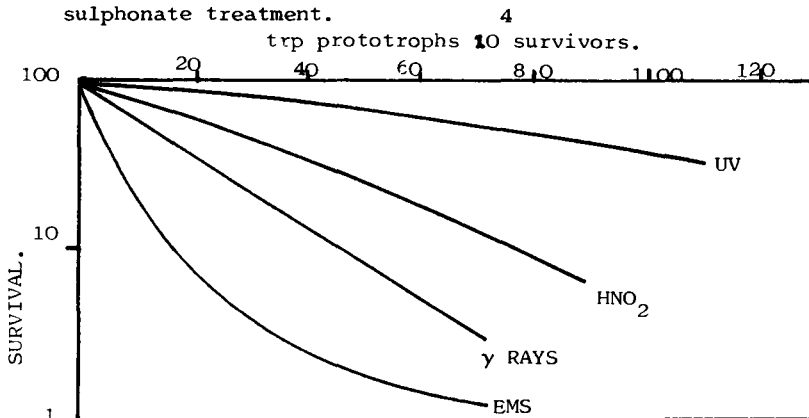

Comparisons made between the frequencies of conversion of the two loci expressed as the ratio of trp^+/his^+ prototrophs showed that at low doses of mutagen the tryptophan locus showed a higher rate of induction whereas at high mutagen doses the histidine locus showed the higher rate.

When the frequency of recessive homozygosis was plotted against cell viability as shown in Figure 2 the results of each mutagen treatment was found to fall on the same curve. Thus in contrast to the variation in gene conversion frequency produced by the different mutagens the frequency of mitotic intergenic recombination was dependent only upon the viability of the culture.

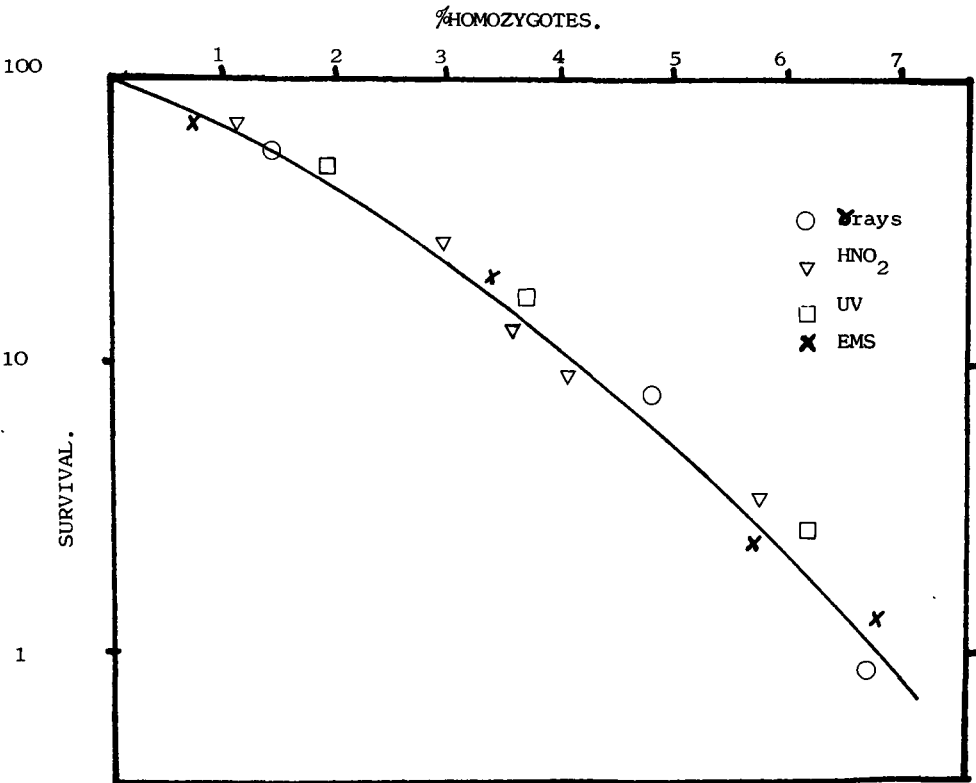

Results of Project No.: 2.

Head of Project and scientific staff: Dr. James M. Parry,
Dr. Charles E. Deutch and
Mr. W.E.Evans.

Title of Project: Macromolecular content and UV-sensitivity of
Saccharomyces cerevisiae during growth in
different media.

Description of results:

The amounts of DNA, RNA and protein per cell were determined for exponential-phase and stationary-phase yeasts grown in different media. The media used were yeast complete (enriched) medium, double and triple strength yeast complete medium and yeast nitrogen base + glucose minimal medium. The DNA content per cell was essentially the same for both growth phases and approximately the same values were obtained for all the media used. This suggests that DNA synthesis does not involve multiple replication points within each replicon. The RNA and protein contents per cell were higher during exponential phase than in stationary phase, although again there were few differences among the various media.

The sensitivity of exponential-phase and stationary-phase yeasts to UV irradiation was determined for cells grown in enriched and minimal media. Exponential-phase cultures were consistently more resistant to UV irradiation than stationary-phase cultures in all the media tested. Variation in growth media was found to have little or no effect upon the UV sensitivity of the cultures. These results suggest that yeast cultures differ from bacteria in that their UV sensitivity is much less effected by pre-irradiation growth conditions.

These experiments have been extended to a study of the sensitivity of exponential and stationary-phase cultures of yeast to inactivation by heat treatment and alkylating agents. In contrast to the results obtained with UV irradiation, yeast cells were significantly more sensitive to heat and alkylating agents during the exponential phase of growth.

Results of Project No. : 3

Head of Project and scientific staff: Dr. James M. Parry

Title of Project: The detection of chromosome non-disjunction
in yeast.

Description of results:

A number of strains of yeast have been constructed which have been used to determine the frequency at mitotic non-disjunction after radiation treatment.

Preliminary experiments have been performed with a diploid yeast culture carrying the heterozygous markers tryptophan-5 and adenine-6 in coupling. These genes are on opposite chromosome arms and are closely linked to the centromere. The production of cells requiring both tryptophan and adenine indicates the production of abnormal karyotypes by the failure of centromere separation during mitotic division. Colonies requiring adenine and tryptophan are detected by their failure to grow on un-supplemented medium. Control cultures show a frequency of adenine and tryptophan requirement of less than 0.01% of viable cells.

Late log phase cultures of yeast exposed to gamma irradiation of up to 120 K rads resulting in \approx 20% cell viability yielded a maximum frequency of 4.7% colonies with a requirement for adenine and tryptophan.

In order to confirm the aneuploid nature of the ade^-trp^- cells, ten individual colonies were sporulated and tetrads isolated. Although all the cultures produced 4-spored axi, only 2 viable cells per ascus were obtained, suggesting that the tetrads were segregating 2:2 for the chromosome constitution $n:n+1$. Suitable controls were performed to determine the frequency of adenine requiring and tryptophan requiring cells produced by mitotic crossing over.

Results of Project No.: 4.

Head of Project and scientific staff: Dr. James M. Parry.

Title of Project: Liquid holding recovery in yeast.

Description of results:

In RAD (wild type) yeast and mutants of the gene rad₄ storage in non-nutrient media after UV irradiation results in an increase in cell viability with dose modification factors of 1.2 and 1.6 respectively. This recovery process is dependent upon the respiratory capacity of the culture and cannot be detected in "petite" (respiratory dependent) strains. Petite cultures do however show liquid holding recovery when incubated in the presence of 0.15% w/v glucose solution. This treatment results in increased viability even though no DNA synthesis could be detected during the holding period.

In contrast mutants of the genes rad₂ and rad₃ undergo a reduction in viability when held under non-nutrient conditions after UV irradiation. This process of "negative liquid holding" is again dependent upon the respiratory capacity of the culture and is absent in petite strains. When petite strains were incubated in glucose solution, liquid holding treatment results in a significant further reduction in cell viability.

The results suggest that both positive and negative liquid holding in yeast cultures are dependent upon the presence of high energy compounds which may be provided by the cell itself in grande strains or by an external sugar source in petite strains.

Indirect evidence suggests that the repair step taking place during liquid holding may be the incision of the DNA backbone near to the site of a UV induced lesion.

Result of Project No: **5**

Head of Project and scientific staff: Dr. James M. Parry &
Dr. Raymond Waters.

Title of Project: The correlation between UV sensitivity and
induced mutation in yeast.

Description of results:

We have reported previously that cultures of yeast carrying the individual mutant alleles of the genes rad₁ and rad₃ show a wide variation in their sensitivities to UV irradiation and nitrous acid but wild-type sensitivity to alkylating agents and ionising radiation.

Individual mutant cultures also show a wide variation in the rate of UV induced mutation to auxotrophy and from sensitivity to resistance to cycloheximide as shown in Figure 1.

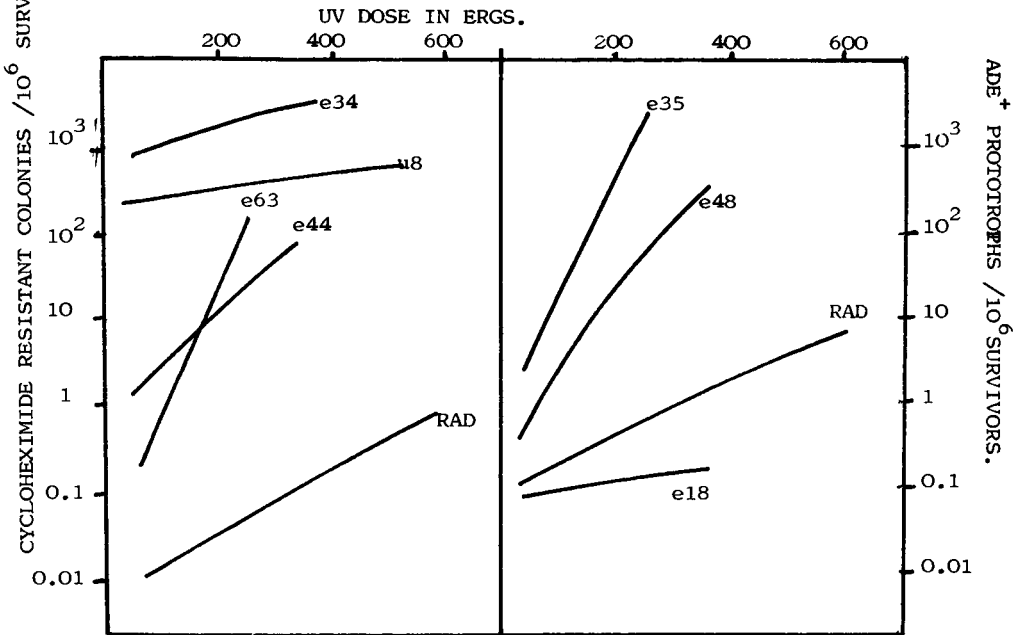

FIG.1. rad₃ ALLELES.

In order to confirm that the variations in mutation rates were related to mutations in the rad₁ and rad₃ genes a number of experiments were performed.

(a) Mutant cultures showing high and low mutation rates were crossed to a RAD culture and after diploid formation and meiosis spore tetrads were analysed. In each cross the phenotypes UV sensitivity and abnormal mutation rate segregated together.

(b) UV sensitive mutants showing a high mutation rate were exposed to the alkylating ethyl methane sulphonate and UV resistant revertants were isolated. For the mutant allele U₁₄ each of the 5 resistance cultures isolated showed a significant reduction in the rate of mutation induction to prototrophy and to cycloheximide resistance.

The results thus indicate that the variation in the rate of UV induced mutation shown by the mutant cultures of rad₁ and rad₃ could not be explained by the presence of a second mutator gene but must be due to the action of the rad₁ and rad₃ genes alone.

Result of Project No: 6.

Head of Project and scientific staff: Dr. James M. Parry &
Dr. Charles E. Deutch.

Title of Project: Sphaeroplast formation in Saccharomyces cerevisiae

Description of results:

The formation of sphaeroplasts is an important preparative stage in the isolation of unsheared DNA. Exponential-phase yeasts can be converted to sphaeroplasts quite easily by treatment with snail-gut enzymes, but older or stationary-phase yeasts tend to be resistant to this treatment. Since recent studies on the genetic effects of UV irradiation on yeast have been performed with stationary-phase cells, the sensitivity of yeast to sphaeroplast formation was examined to see if conditions could be developed for more easily forming sphaeroplasts of stationary-phase yeasts.

It was observed that there is a rapid increase in the resistance of yeasts to sphaeroplast formation during the transition from the exponential phase to the stationary phase of growth. This increase occurs over a relatively narrow segment of the total transition period, and resistance is not related to whether the cells are budding or not. The increase in resistance to sphaeroplast formation can be inhibited by treatment with cyclohexamide or 5-fluorouracil. These observations suggest that the resistance characteristic of stationary-phase yeasts is the result of a specific modification of the cells during the transition period. This modification is dependent on RNA and protein synthesis, and may therefore be the result of the transcription and translation of specific genes during the transition period.

These experiments suggest that it should be possible to isolate mutants of Saccharomyces cerevisiae which are always sensitive to sphaeroplast formation. The incorporation of such mutations in genetically-characterized strains should provide a useful system for studying the effects of UV-irradiation on yeast DNA and correlating these effects with the genetic responses.

Results of Project No: 7

Head of Project and scientific staff: Dr. Elizabeth M. Parry.

Title of Project: The correlation between radiation repair and mutation in regulatory mutants of yeast.

Description of results:

A diploid strain of yeast, 2nL, yields spore tetrads which segregate 2:2 for the phenotypes wild type curve and a U-shaped survival curve after UV irradiation. Previous experiments suggest that the U-shaped phenotype represent a defective regulator gene which is dose dependent and may be involved in the operation of the dark-repair enzyme system after UV exposure.

The products of a four-spored tetrad showing RAD (wild type) and U-shaped survival curves were studied for their ability to undergo UV induced mutation to prototrophy. The results obtained are shown in Figure I. All four spore cultures carry the gene ade_{20} , mutation to prototrophy was detected by plating on minimal medium lacking adenine.

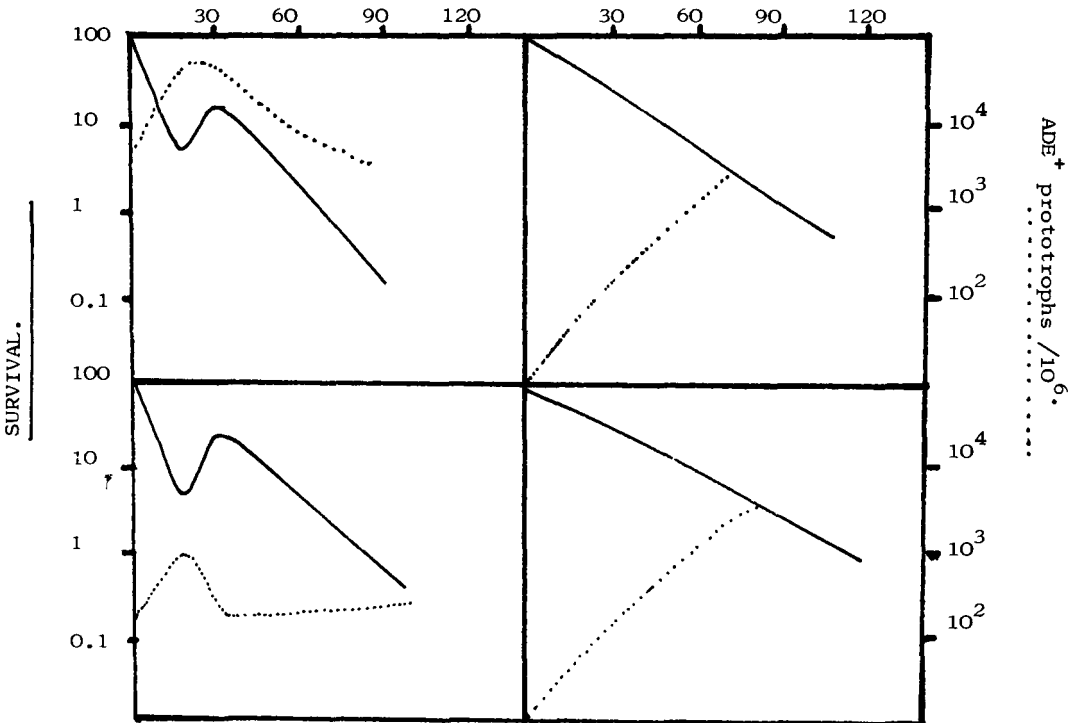

The cultures 8b and 8d which showed a RAD survival curve each show a linear mutation induction curve at low UV doses with a reduced rate at higher exposures. In contrast the two cultures 8a and 8c which showed a U-shaped survival curve showed a peaked induction curve with the period of maximum mutation induction corresponding with the period of maximum low dose sensitivity. Culture 8a was also characterized by a high level of spontaneous mutation.

The results obtained suggest that repair activity during the U-shaped portion of the survival curves of 8a and 8c are characterized by an "error-proneness" which leads to high levels of mutation to prototrophy. At higher exposures of UV the induction of a relatively "error-free" repair system would lead to the observed reduction in the induced mutation rate.

Result of Project No: 8 .

Head of Project and scientific staff: Dr. James M. Parry

Title of Projects: The effects of temperature change upon UV
induced mitotic recombination and cell death in
yeast

Description of results:

In yeast, post treatment with visible light and liquid holding in non-nutrient medium after UV irradiation has been shown to result in significant changes in the yield of viable cells and both mitotic and inter- and intragenic recombinants.

Experiments have been performed to determine the effects of incubation at high temperature (50°) after UV irradiation upon cell viability and mitotic recombination. Post UV heat treatment was shown to produce a number of effects:

(1) Cell viability showed a small but significant increase up to 5 mins. heat post treatment, with a fall in viability after longer durations at 50° .

(2) The yield of prototrophs produced by mitotic gene conversion showed a reduction after 5 min. heat treatment with no further change after longer durations at 50° .

(3) The yield of recessive homozygous colonies produced by mitotic intergenic recombination was reduced by heat treatment of up to 5 min. but at longer exposures the yield of homozygotes increased to a frequency greater than obtained after UV exposure alone.

The effects of heat post-treatments on UV irradiated yeast cultures suggest at least two possible explanations from the observed results.

(a) The effect of heat post-treatment may involve the reversal of UV induced hydration products or some similar heat sensitive damage. Previous experiments with UV treated yeast cultures have demonstrated that a fraction of the UV induced events leading to cell death, mitotic recombination and mutataion to prototrophy are resistant to such treatments as photoreactivating light and liquid holding treatment. . It may be postulated that this resistant fraction may at least in part owe its origin to heat or acid sensitive lesions. The increase in cell death and intergenic recombination produced by periods of heat treatment longer than 5 min. may result from heat induced single strand breaks.

(b) The other possibility is that heat post-treatment may influence the activity of the enzymes of dark repair in the yeast. If heat post-treatment results in an increase in the activity of the enzymes of dark repair, there may be a resulting increase in the rate of repair of lesions leading to cell death and mitotic inter- and intragenic recombination. At longer durations of heat treatment the changes in cell viability and mitotic recombination may result from heat induced damage to the cellular repair enzymes.

Result of Project No: 9.

Head of Project and scientific staff: Dr. Elizabeth M. Parry &

Mr. W. E. Evans

Title of Project: The isolation of repair-defective mutants of yeast.

Description of results:

(a) Temperature-sensitive mutants (ts-rad)

A large number (≈ 200) yeast mutants have been isolated on the basis of their increased sensitivity to UV radiation when grown at 37° . The mutants all grow normally at 37° in the absence of UV irradiation and show wild type UV sensitivity at 28° . Individual mutants have all been shown to result from the action of single Mendelian genes and complementation tests and genetic analyses are being performed to determine the relationships between the individual mutant cultures.

In preparation for the use of the ts-rad in the study of the repair of genetic damage individual mutants have been screened for their sensitivity to ionising radiations and chemical mutagens. A simple plate test has been developed to enable the rapid determination of the sensitivity of an individual mutant to a range of mutagen treatments.

ts-rad mutants are now available which show sensitivity to gamma irradiation, nitrous acid, ethyl methane sulphonate, methyl methane sulphonate and N-methyl-N-nitro-N-nitrosoguanidine at the non-permissive temperature of 37° .

(b) Heat-sensitive mutants (hs).

17 mutants have been isolated on the basis of their sensitivity to mild heat treatment at 52° . Unlike temperature sensitive mutants which show no growth at 37° but are not inactivated when stored at 37° the hs mutants show reduced cell viability when stored under non-nutrient conditions at 37° . This reduced cell viability is observable after 14 days incubation even at the low temperature of 28° .

All 17 hs mutants were also sensitive to gamma irradiation and also to ethyl methane sulphonate. Gamma ray sensitivity was characterized by increased sensitivity at low doses but all mutants showed a characteristic resistant tail at high doses

Publications

Evans, W. E. & Parry, J. M. Thermal inactivation of yeast cells

Heredity 31 133 (abst) (1973)

Parry, E. M. & Parry, J. M. Genetic analysis of UV inactivation,

recovery and regulatory phenomena in a strain of its yeast Saccharomyces cerevisiae Molec. gen.Genet. 124 117-133 (1973)

Parry, J. M. & Parry, E. M. Allele interaction at the rad₁ locus in

diploid cultures of UV-irradiated yeast Radiation Res. (1973) 55 29-40

Parry, J. M. The induction of gene conversion in yeast by herbicide preparations. Mutation Res. 21 38-91 (1973)

Walters, R. & Parry, J. M. The response to chemical mutagens of the

individual haploid and homoallelic diploid UV sensitive mutants of the rad₃ locus of Saccharomyces cerevisiae Molec. gen.Genet. 124 135-145 1973

Walters, R. & Parry, J. M. A comparative study of the effects of UV

irradiation upon diploid cultures of yeast defective at the rad₃ locus Molec. gen.Genet. 124 145-156 (1973)

In Press

Deutch, C. E. & Parry, J. M. Sphaeroplast formation in yeast during

the transition from exponential phase to stationary phase J. gen.

Microbiol.

Parry, J. M. The evaluation of chemicals for mutagenicity. Prevent.

Istituto di Genetica dell'Università, Milan, Italy

Istituto di Genetica dell'Università, Pisa, Italy

Contract N. 111-72-1 BIOD

Prof. G.E. Magni and Prof. N. Loprieno

MOLECULAR NATURE OF POINT MUTATIONS INDUCED BY X-RADIATIONS

Summary - The purpose of the program is to obtain evidence on a large scale on the distribution of molecular types of mutations in eucaryotic organisms. The research is carried out on two organisms each showing useful properties for such investigation (Sacch. cerevisiae and Schiz. pombe).

In Sacch. cerevisiae a procedure was set up for the study of relative proportions of transitions (AT \rightarrow GC and GC \rightarrow AT) and transversions on a large number of independent mutations. Complete dose/effect curves can now be obtained, but it was thought that cells of uniform sensitivity to X-radiations should be used for the final experiments. A synchronisation procedure was studied and gave satisfactory results.

In Schiz. pombe evidence was obtained that the frequency and the molecular nature of mutations induced by X-radiations strictly depend on repair mechanisms.

Mutability by X-radiations is much lower in a repair deficient strain (rad 10-198) than in the wild type.

Among forward mutations obtained in strain rad 10-198 only 2% are leaky while in the wild type up to 20% is the normal rate of leakiness, indicating that the molecular types of induced mutation could be different in the two strain.

Project N. 1

Prof.G.E.Magni,Prof.G.P.Sironi,Dr.S.Sora,Dr.L.Panzeri

Molecular nature of point mutation induced by X-radiation in
Sacch.cerevisiae

The aim of research carried out during the last year was to set up a very precise procedure for quantitative determination of the two types of transitions and transversions induced by X-radiations.

a) Synchronization of repair mechanisms

Yeast cells of a normal culture do not show a uniform radiation-sensitivity but are a mixed population of sensitive and resistant cells (the latter being the budding cells). At the present state of our knowledge, it is impossible to say whether repair mechanisms are equally efficient on transitions AT→GC, GC→AT and transversions. It was therefore mandatory to try a synchronisation in order to have available for the mutagenic treatment cells of uniform radiation-sensitivity. The procedure adopted after many trials is in summary the following : growth of yeast cultures in YEPD medium to stationary phase, starvation for dextrose (2 to 4 days), centrifugation in discontinuous sorbitol gradient and isolation of single cells uniformly sized. During subsequent growth in YEPD, cells are rather well synchronized for at least two generations as judged by following DNA synthesis, appearance of very small buds and final cell division. Samples of a synchronized culture show dramatic changes in their radiation-sensitivity. Fig. AI and AII are examples of our synchronization demonstrated by cell duplication and DNA synthesis respectively. Samples taken at time intervals indicated by arrows were irradiated and showed survival to x-radiations of Fig.B. Population n.4 contains such a small amount of sensitive cells that survivors to doses of 20 krad and higher can be considered as being 100% fully resistant cells where repair mechanism are completely expressed. The molecular specificity of X-radiations

is, for time being, studied on such kind of cells.

b) Frequency of transitions and transversions induced by X-radiations

The method for a quantitative estimate of transitions and transversions is rather complicated and will be described in the next report together with final experimental results. It is based on the reversion to wild type of a nonsense codon and on the transitions from ochre to amber and viceversa.

Preliminary results on small samples have shown that X-radiation can induce any type of base substitution. During next year we plan to obtain complete dose/effect curves (from 20 to 120 Krad) for the relative proportion of transitions and transversions based on at least 100 mutants per dose, using synchronized cells.

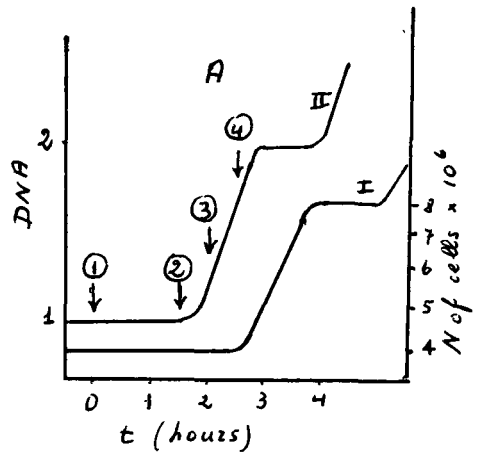
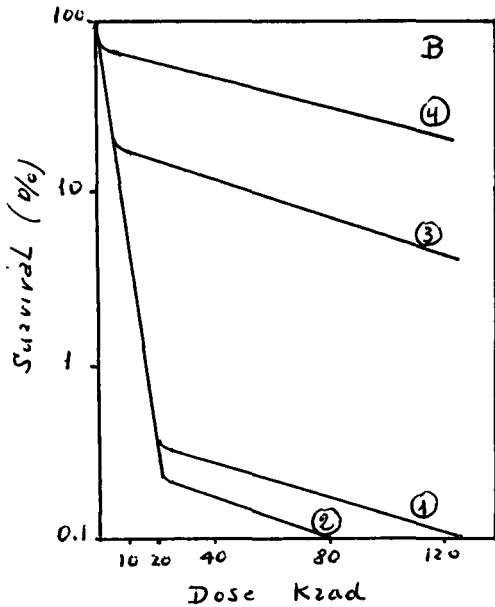

Fig. A. Synchronisation of yeast cells for : I cell duplication and II DNA synthesis.

Fig. B. Survival curves to X-radiation of cell samples taken at points 1, 2, 3, 4 of the synchronisation curve.

Project N. 2

Prof. N.Loprieno and Dr. A.Abbondandolo, Dr. S.Baroncelli,
Dr. M.Simili, Dr. R.Barale.

Molecular nature of point mutations induced by X-radiations
in Schiz.pombe.

Progress report

Experiments for collecting mutants to be further analyzed from G₁ cells treated by three different doses of X-rays have been completed: samples of ca. 100 mutants from each X-rays dose have been isolated at survival levels in the range from 40% to 3%. From these experiments no significant increase of mutation frequency induction with the dose has been observed, although in the control no spontaneous mutations were observed. It has been further established that G₁ cells respond to the mutagenic treatment, a finding already known from several reverse mutations experiments done with other auxotrophic strains of S.pombe (1,2). The experiments done with a repair-deficient strain of S.pombe, rad10-198 (previously known as uvs10-198) have allowed the following conclusions

- 1) the mutation frequency induced by three different treatments of X-rays in the rad10-198 strain does not increase with dose, but it is different from the spontaneous one at $P < 0.05$;
- 2) No differences in the distribution of mutations among ade6 and ade7 loci were observed with dose; about 70% of mutants were in the ade6 locus, indicating a greater mutability of this locus compared to the ade6 locus (Loprieno et al., 1969).
- 3) The amount of leaky mutations induced by X-rays treatments in all samples has been 2.2%, compared to 22.1% observed in the untreated samples (Loprieno, 1973).

In order to evaluate the kinetics of the mutation induction by X-rays in the repair-deficient strain in a forward mutations system, experiments have been developed with the isogenic strains ade6-60/rad10-198,h⁻ and ade6-60/rad⁺,h⁻ : in both strains mutations at five loci can be analyzed (Gutz et al., 1974). These experiments have shown that:

- 1) In the wild type strain the log of survival is proportional to the square of the dose, whereas in the repair-deficient strain the log of survival is linearly proportional to the dose: the one hit kinetic of inactivation in the ade6-60/rad10-198,h⁻ strain is the demonstration of the lack in this strain of processes able to repair the alterations induced by X-rays.
- 2) The regression analysis of the relationship between inactivation and mutation induction clearly shows that the apparently higher mutability of the repair deficient strain depends largely on the spontaneous mutability and on the sensitivity to the lethality induced by X-rays.
- 3) The analysis of the K/Ko ratio for the two strains (wild type and repair-deficient) at the different doses of treatment shows that in the wild type the production of mutation is related to the repair ability of the strain and therefore the mutations induced by X-rays are the result of the repair-processes; the K/Ko ratio is very low with the repair-deficient strain.

These data confirm our previous results in a system in which the possibility of selection of mutants has been ruled out.

The following papers are ready to be submitted for publications:

- 1) Abbondandolo, A. et al.: Mutation and nuclear stage in S.pombe.
I. A genetic system for studying the role of recombinational repair in mutation induction.
- 2) Abbondandolo, A. et al.: Mutation and nuclear stage in S.pombe.
II. Reverse mutations induced by X rays in the absence of recombinational repair.

Contractant de la Commission : Université Libre de
Bruxelles.

N° du contrat : 009-72-1 BIA8

Chef du (des) groupe(s) de recherche : Jean BPACHET.

Thème général du contrat : Effets des radiations
sur la stabilité de l'information génétique.

Description générale succincte des travaux réalisés

The effects of radiations on a great variety of biological systems have been studied. Their complexity varied from bacteriophages to rabbits. The following problems have been studied in 1973.

1) Bacteria and bacteriophages. New models, based on experimental facts, have been developed in order to explain DNA repair, induced mutagenesis, bacterial and viral recombination, DNA replication and regulation of gene activity in phages.

Experimental work has dealt with : repair of ray lesions in phage λ irradiated in vitro and in the cell; induced DNA repair; protection by proflavine of phage λ against γ rays; mechanism of integration of phage μ in bacteria; control of genetic expression in bacterial proviruses.

2) Cells and embryos. Most of the work has been done on tissue culture cells.

The following points have been investigated : phage infection of human galactosemic cells; chromosome and chromatid exchanges in chinese hamster cells, as well as in normal and Xeroderma pigmentosum fibroblasts; influence of bromodeoxyuridine on DNA repair after UV irradiation; radiosensitization of mammalian cells by caffeine; pyrimidine dimer excision in mammalian cells; DNA replication and chromatid somatic recombination in hamster cells; effects of X-irradiation sister, dibutyryl cAMP and cytochalasin B on glial tumor cells, including their malignancy; radiosensitivity of somatic hybrids.

The following studies have been done on early mouse embryos : effects of radiations on development and on ultrastructure; analysis of nucleic acid metabolism during cleavage; effects of hydroxyurea on cleavage.

3) Immunological studies with irradiated rabbits. Experiments on the transfer of genetically marked, immunocompetent cells in irradiated rabbits suggest that the appearance of idiotypic specificities of the donor in the immunoglobulins produced by the receptor animal is due to a derepression of the corresponding gene in the cells of the receptor. Other experiments indicate that memory cells transfer some kind of information to the fast dividing cells which will produce antibodies, and that the undifferentiated cells, which are the precursors of the receptor-containing cells are in constant division. Evidence for a cell to cell transfer of a tolerance factor has also been obtained.

Résultats du projet n° I.

Chef du projet et collaborateurs scientifiques :
A.J. Bertinchamps, S. Gregoli, R. Mathur-Devré, M. Olast.

Titre du projet : Primary Effects of Radiation on
Nucleic Acids.

A. ESR Investigations

The role of water in the radiolysis of nucleic acids submitted in vivo to ionizing radiations still remains a point of controversy. For example, the local concentration of nucleic acids within the cell often exceeds by hundreds of times the saturation conditions. In such a compact configuration the arrangement of water molecules around the DNA is quite different from that of a DNA aqueous solution. The problem of choosing in vitro the experimental conditions which more closely approximate those of living material submitted to ionizing radiations, is therefore open.

To gain information on this point we undertook an ESR investigation on the formation of free radicals on DNA and RNA derivatives submitted to γ -radiations in frozen aqueous solution. From the radiological point of view; such a solution can be considered, as intermediate between the liquid and the dry state. As in the liquid state, the solute molecules are surrounded by a large number of water molecules, but, as in the dry state, the molecular mobility is very small. This confers peculiar radiochemical properties to the system because the diffusion rate of the reactive species which are created by the radiolysis of water is so small within the icy matrix that the probability of involvement into chemical reactions is strongly diminished. Furthermore, and in spite of the fact that the primary effects are originally identical, the direct action of radiation on solute molecules cannot be compared, at priori, with the situation in the dry state; in the frozen state, however, the primary radical species can react with closely neighbouring water molecules and be converted into other radical species which are unrealizable in the dry state.

The first results show that, in the frozen state, indirect action is not involved into the formation of free radicals on the nucleic acid derivatives. The physical conditions are such that water radicals deactivate before reaching the solute molecules by diffusion. Concerning direct

action, the comparison of the present results with previous ones obtained in the dry state, confirms that the primary species consist, in both cases, of ionic populations of both signs. Their fate in the frozen matrix is however quite different upon warming from that observed in the dry state. Thermal vibrations confer mobility to the water lattice, and several free radical reactions involving the primary ions and the water, can now be detected and investigated "in slow motion".

From the ESR point of view, this process is visualized by large changes in spectrum shape and intensity taking place during thermal annealing. Since at each temperature, the experimental ESR spectra consist of a weighted superimposition of different elementary patterns, mostly arising from still unidentified radicals, the detailed information carried on by the ESR data is not directly available. Two different techniques were then applied in parallel. The first involved the use of specific radical scavengers for reducing the complexity of the "slowly moving" total radical population. The second consisted in the graphic processing of experimental spectra by means of computer. It turns out that subtraction from a composite spectrum of one or more component patterns already identified leads, in some cases, to the complete decomposition of the spectrum under study. Both the chemical and the graphic approaches were successfully applied to trace a complete story of γ -induced radicals in dAMP, and to clear up individual temperature kinetics. From this study it appears very likely that the primary anions and cations react respectively with the H^+ and the OH^- normally present in water, to form respectively H-addition and OH-addition radicals.

A preliminary investigation showed that most conclusions already drawn for dAMP, can easily be extended to the other nucleotides.

B. NMR Investigations

In order to understand the role of water in stabilizing the helix structure and in the energy transfer process in aqueous DNA solutions, the extent of hydration (H_2O bound to DNA) and the mobility of these bound water protons in frozen aqueous solutions (-5° to $-35^\circ C$) of DNA, polynucleotides and their complexes have been studied by means of the NMR technique. Relaxation

times T_2 have been calculated from half line width ($\Delta\nu_{\frac{1}{2}}$) values (broad peaks indicative of slow motion). In contrast with the proton signal from pure H_2O which becomes too broad to be immediately observable upon freezing, broad water proton peaks (32-90 Hz at $-5^\circ C$) were observed in the presence of DNA or of polynucleotides in frozen solution. The mobility of water protons in the hydration layer (responsible for the observed signals) is therefore much higher than in ice. The results show that the area under the observed signals (for DNA and polynucleotides) and $\Delta\nu_{\frac{1}{2}}$ (for DNA only) are dependent on concentration of the polymer. Irradiation of DNA solutions at $0^\circ C$ indicates an increase in the mobility of bound H_2O and in the activation energy from 4.0-5.0 Kcals/mole to 8.0-10.0 Kcals/mole. Irradiation of polynucleotides solutions do not show similar variations in T_2 and E_a (activation energy) values. In general it may be concluded that the water bound to DNA and polynucleotides is not "ice-like" but has much less ordered structure than ice though more restricted in mobility than liquid water.

List of publications

Electron transfer in γ irradiated complexes between aromatic amino acids and DNA derivatives.

M. Olast and A.J. Bertinchamps.

Int. J. Radiat. Biol. 1973, Vol. 24, n° 6, 589-594.

An NMR Study of the Relative Interaction Abilities of different Pyrimidine Nucleosides with Serotonin.

R. Mathur-Devré and A.J. Bertinchamps.

Submitted for publication to Biophysik.

Résultats du projet n° II

Chef du projet et collaborateurs scientifiques : M. Errera, P. Caillet-Fauquet, J. Cornelis, M. Defais, A. Miller-Faurès, M. Radman, J. Rommelaere, B. Srivastava, M. Susskind, F. Tondeur

Titre du projet : Mécanismes de la réparation du DNA chez les microorganismes (*E.coli*- λ) et les cellules de mammifères

I. *E. Coli* - phage λ system

1. Repair of γ ray lesions produced in phage λ irradiated in vitro and in the cell (B.S. Srivastava)

a) When phage is irradiated in vitro, the genes *uvrA*⁺, *polA*⁺ of *E.coli* and *red*⁺ of λ are necessary for maximum repair.

b) When phage DNA is irradiated in the host bacteria, gene *polA*⁺ repairs rapidly the majority of single strand breaks even at 0°, the remaining ones are slowly repaired at 37°C ; the *rec*, *lex* and *uvr* functions are not necessary.

c) A new mutation of *E.coli*, mapped between *argH* and *purD*, prevents the slow repair of single strand breaks. This mutant is sensitive both to U.V. and X rays, but is capable of normal recombination.

2. Implications of the replication and recombination functions on the maturation of phage λ DNA (B.S. Srivastava : collaboration with J. De Lafonteyne, Laboratory of Genetics)

3. Induced DNA repair (P. Caillet-Fauquet, M. Defais)

Irradiation of *E.coli* by X or U.V. rays increases the survival of U.V. irradiated phage.

a) This mechanism is probably induced because it is inhibited by about 50 p.c. by chloramphenicol and in a rifampicin resistant strain (defective in one of the RNA polymerase units). Uracil⁻ strain isogenic with the *uvrA* strain used sofar is being "prepared" and should enable a better control of induction.

b) The latency in DNA synthesis of irradiated phage does not seem to be modified by irradiation of the bacterial host.

4. Protection by proflavine of bacteriophage λ against γ rays (G. Michel-Maenhaut)

In conditions where indirect effects are predominant radioprotection by proflavine is concerned both with the capsid dependent DNA injection mechanism and with the decrease of single strand breaks produced in the DNA. When direct effects are predominant, DNA is protected presumably both against strand breakage and base damage and this occurs probably by a mechanism of electron transfer from the bases towards intercalated proflavine.

5. Writing-up of works, accomplished at Harvard University, on two endonucleases specific for UV-irradiated DNA. (M. Radman)

6. Development of a theory ("SOS repair hypothesis") concerning the mechanism of DNA repair and induced mutagenesis. (M. Radman)

II. Mammalian cells

1. Chromosome and chromatid exchanges in chinese hamster cells (J. Rommelaere, M. Susskind, M. Errera)

Both sister chromatid exchanges and localised exchanges of DNA between chromosomes in ^3H and ^{14}C tetraploid synkarions were scored and found to increase after U.V. irradiation.

2. Chromatid exchanges in normal and Xeroderma pigmentosum(XP) fibroblasts (M. Susskind)

Preliminary results suggest that spontaneous chromatid exchanges are more frequent in XP cells than in normal fibroblasts.

3. Biochemical studies of DNA replication and sister chromatid somatic recombination in chinese hamster cells (J. Rommelaere, A. Miller-Faurès)

From cells grown during one generation in BUdR a population of DNA intermediate density, probably formed from covalently linked light and heavy chains can be isolated in alkaline CsCl gradients - these could be the result of sister chromatid recombinations. In neutral gradients, molecules of intermediate density can be interpreted as belonging to the replicating DNA forks.

4. Influence of 5 bromodeoxyuridine on DNA repair in chinese hamster cells exposed to U.V. irradiation (J. Rommelaere, J.J. Cornelis, A. Miller-Faurès, M. Errera) (accepted BBA)

During repair of induced breaks in the BUdR substituted regions of the DNA, about 100 bases or less may be inserted in the DNA. These breaks contribute to the elimination of pyrimidine dimers produced in the unsubstituted regions.

5. Pyrimidine dimer excision in mammalian cells (J.J. Cornelis)

In non synchronized HeLa cells, 50 p.c. of dimers are eliminated after 4-5 h and 100 p.c. after 48 hours. Synchronisation of the cell population does not affect the initial rate of excision. In chinese hamster cells, dimers are not excised nor do they seem to be released from the DNA as long acid insoluble oligonucleotides.

6. Radiosensitisation of mammalian cells by caffeine (F. Tondeur)

Radioactivity from methyl ^3H caffeine is found in DNA and appears as labelled thymidine when a DNA hydrolysate is analyzed.

Publications

- J. Rommelaere, M. Susskind and M. Errera
Chromosome and chromatid exchanges in Chinese Hamster cells
Chromosoma, 41, 243-257 (1973)
- B.S. Srivastava
Repair of gamma-ray-induced damage in bacteriophage λ
Virology, 55, 550-553 (1973)
- J. Rommelaere and M. Errera
Unscheduled DNA synthesis and repair replication in UV-irradiated
Chinese Hamster cells
Arch. Internat. Physiol. Bioch., 81, 200-202 (1973)
- J. Rommelaere, J.J. Cornelis, A. Miller-Faures and M. Errera
The influence of 5-bromodeoxyuridine on DNA repair in Chinese Hamster
cells exposed to ultraviolet radiation
Biochim. Biophys. Acta (in press)
- M. Radman
An endonuclease from E.coli that introduces single polynucleotide chain
scissions in ultraviolet-irradiated DNA (submitted to J. Mol. Biol.)
- M. Radman
Phenomenology of an inducible mutagenic DNA repair pathway in E.coli :
SOS repair hypothesis, in "Molecular and Environmental Aspects of Mutagenesis",
C.C. Thomas Publ. Springfield, Ill.
- M. Radman
SOS repair : an inducible mutagenic DNA repair
Squaw Valley Conferences, Abstract Book
- M. Radman, J. Rommelaere and M. Errera
Stability and evolution of DNA from the point of view of molecular
radiobiology in "Physico chemical properties of nucleic acids" ed. J. Duchesne,
Academic Press 1973, chapter 22, pp. 162-201

Résultats du projet n° III

Chef du projet : R. THOMAS and coll.

Titre du projet : The establishment and stability of the state of provirus : genetic factors and effects of physical agents.

1. Mechanism of provirus integration in bacterial and mammalian cells

("Mutator" phage Mu : M. Couturier, J. De Lafonteyne, M. Faelen, F. Van Vliet; oncogenic viruses : S. Mousset)

As found independently by Wijffelman et al. (from the Rijswijk TNO Laboratory), general recombination in phage Mu is completely dependent on the bacterial rec functions (Couturier and Van Vliet, inpress). There is a distinct mechanism by which Mu promotes integrative recombination of completely unrelated DNA sequences (Toussaint and Faelen, Nature 1973). More recent data show that in some conditions there occurs a tandem duplication of phage Mu within the bacterial chromosome; it would be interesting to understand the mechanism of this phenomenon, in view of the evolutive role of genetic duplications.

Theoretical and experimental approaches have led De Lafonteyne (thesis) to a general model which integrates the roles of bacterial and viral recombination mechanisms and their interference with replication.

The nature of cellular permissivity towards oncogenic viruses is under investigation, using as a tool semi-permissive systems (human cells infected with SV40; hamster cells infected with SV40 or polyoma).

2. Control of genetic expression in bacterial proviruses and in higher systems

(bacteria and temperate phages : J.P. Lecocq, C. Dambly, L. Desmet, A.M. Gathoye, H. Garcia, C. Toussaint, R. Srivastava, M. Delstanche, R. Lathe and R. Thomas; mammalian cells : C. and J. Szpirer, A. Résibois, R. Van Geffel)

- a) Logic approach. A language has been developed in order to describe and treat complex models in the field of regulatory circuits (Thomas, J. Theoret. Biol. 1973). It is now operational, and currently used, in conjunction with experimentation, to study the control of immunity in temperate bacteriophages.
- b) This year, studies about the control of immunity in temperate phages have been devoted for a great deal to the role of the bacterial transcription machinery in the expression of the viral genes. Bacterial mutations affecting transcription have dramatic effects on the behavior of infecting phage. One particular bacterial mutant, affected in the structure of the β subunit of RNA polymerase permits almost normal growth of N^- mutants of λ (gene N codes for a positive regulator whose role is essential in normal strains). Bacterial su_A mutations, which suppress polarity, also suppress the requirement for the N product at the level of some but not all terminators.

c) Studies with mammalian cells. Hybridization experiments have been performed between mouse hepatoma cells and fibroblasts. The first type synthesizes various hepatic proteins as well as α -fetoprotein. It was shown by C. and J. Szpirer that the synthesis of these proteins obey distinct controls : most hybrids produce transferrin and protein C3, but none of them produce albumin or α -fetoprotein.

3. Studies with human cell lines carrying genetic defects (A.Résibois,R.Van Geffel)

The situation about the reproducibility of the "Merril phenomenon" (cure of human galactosemic cells following treatment with transducing bacteriophage carrying a bacterial gal operon) is still unclear. We hope to get a clear answer, in view of two technical improvements (It is now possible to select efficiently gal⁺ cells in a well buffered system, and one can use a gal⁻ line transformed by SV40). Autoradiographic methods permit a clear distinction between normal and gal⁻ (transferase) cells; the method has been used here with amniotic cells, and it should allow a pre-natal diagnostic of galactosemy.

Publications

- COUTURIER, M., DAMBLY, C. and THOMAS, T.
Control of development in temperate bacteriophages.
V. Sequential activation of viral functions.
Molec. Gen. Genet., 120, 231-252 (1973).
- LECOQ, J.P.
Aspects génétiques et biochimiques de la régulation de la transcription chez la bactérie *E.coli* et ses phages.
Biochimie, 55, 1-4 (1973).
- TOUSSAINT, A. and FAELEN, M.
Connecting two unrelated DNA sequences with a Mu dimer.
Nature New Biol., 242, 1-4 (1973).
- MOUSSET, S. and BLANGY, D.
Properties of a SV40-transformed AGMK cell line : interactions between SV40 and cellular DNA metabolism.
Virology, 52, 385-394 (1973).
- LECOQ, J.P. and DAMBLY, C.
Effets d'une mutation affectant la sous-unité β de la RNA polymérase d'*E.coli* sur le comportement du bactériophage λ .
Arch. Internat. Physiol. Bioch., 81, 383-384 (1973).
- FAELEN, M. and TOUSSAINT, A.
Isolation of conditional defective mutants of temperate phage Mu-1 and deletion mapping of the Mu-1 prophage.
Virology, 54, 117-124 (1973).
- LECOQ, J.P. and GATHOYE, A.M.
Une mutation bactérienne augmentant la fréquence de lysogénéisation par le phage λ .
Arch. Internat. Physiol. Bioch., 81, 803 (1973).
- THOMAS, R.
Essais sur la formulation et le traitement algébriques des raisonnements.
I. Formulation et traitement de séries d'implications complexes.
Automatisme, 18, 410-415 (1973).
- THOMAS, R.
Boolean formalization of genetic control circuits.
J. Theoret. Biol., 42, 563-585 (1973).

Résultats du projet IV.

Chef du Projet et collaborateurs scientifiques : J. Brachet.
Collaborateurs : H. Alexandre, Y. Gerin, V. Heilporn, A. Lievens, G. Limbosch, F. Zampetti.

Titre du projet:

1. Early mouse embryos development. Nucleic acid metabolism and radiosensitivity
2. Effects of different treatments on the morphology and the X-ray sensitivity of mammalian cells.

1. a. Effects of X-radiation on preimplantation mouse embryos cultured in vitro. (H. Alexandre, Y. Gerin).

1. Radiation effects on the development. Samples of 2-cell, 4-cell, 16-cell mouse eggs and morulae were irradiated with doses ranging between 50 and 1000 R. It was observed that X-irradiation of 2-cell ova produces a delay of several hours in the next cleavage; such a delay is not observed after irradiation of advanced morulae, where the time required for formation of the blastocoele is the same in the irradiated and control groups.

The most significant effect of X-radiation at the two-cell stage is the inhibition of primary differentiation by doses greater than 200 R.; with this dose, about 50% of the embryos can differentiate. Lower doses, which do not inhibit blastocoele formation, block hatching: the embryos become atretic within the zona pellucida. This could result from a smaller blastocyst cell number, since the blastocysts with the fewest cells have the greatest difficulty in hatching. When X-rays are applied to advanced morulae, they no longer inhibit primary differentiation; however, a very small number of the blastocysts derived from morulae irradiated with 200 R eventually hatch.

2. Radiation effects on the ultrastructure of mouse eggs. Two-cell stage eggs were irradiated with 200 R (50% inhibition of primary differentiation) and 400 R (100% inhibition). They were fixed 24 (4-8 cell stage), 48 (morulae) and 72 hours (blastocysts) later. Many glycogen polygranules are seen within the intercellular spaces. They seem to originate from cytoplasmic vesicles and are also present in the blastocoele. Such X-ray doses do not affect the differentiation of the nucleolus. Thus the arrest of development seems unrelated to an inhibition of nucleolar RNA synthesis. Micronuclei are observed in the blocked morulae (400 R) as well as many lytic areas (myelinic structures, cytolysomes, etc.).

b. Nucleic acid metabolism during cleavage.

1. Autoradiography. Deoxyuridine is actively incorporated into DNA in cleaving mouse embryos (2-cell, 4-8 cell, morulae, blastocysts), with the same pattern as that described by Barlow et al. (1972) for thymidine. This indicates that thymidylate synthetase is active as early as the 2-cell stage.

In order to demonstrate the existence of ribonucleotide reductase activity, embryos were incubated with ³H uridine (2-cell stage: 6 h.; other stages: 4 h.), fixed and air-dried on slides, and finally treated with DNase, RNase and a DNAase + RNAase mixture. Nucleolar and extranucleolar uridine incorporation occurs very soon after fertilization (2 cell stage) and increases afterwards. The RNAase treatment removes all the nucleolar label, but the nucleoplasmic and cytoplasmic labels are only partially removed. The latter remains after successive treatments with DNAase and RNAase. This could result from a partial incorporation of the labelled nucleoside into polysaccharide (Piko, 1970).

2. Effects of hydroxyurea on early development. Cleavage is blocked at the 4-8 cell stage when 10^{-2} or 10^{-3} M hydroxyurea is added at the 2 cell stage. The same concentrations, if applied at the 4-8 cell stage and morulae, immediately inhibit development. At the concentration of 10^{-4} M, hydroxyurea has little effect on primary differentiation. The effect is reversible if 2 cell eggs are treated for 4 hours. These preliminary results differ from those obtained by Brachet (1968) on sea urchin eggs. They suggest that reduction of ribonucleotides to deoxyribonucleotides does not occur in mammalian eggs or that this reduction is not necessary for primary differentiation.

2. a. Effects of cytochalasin B on rat glial tumor cells and on chinese hamster fibroblasts. (V. Heilporn, A. Lievens, S. Limbosch, F. Zampetti).

Cytochalasin B, at the concentration of 5 µg/ml, induces in rat glial tumor cells the appearance of very long cytoplasmic processes. Furthermore, DNA synthesis is slightly inhibited in the presence of this drug. The ability of cytochalasin B to induce binucleate cell populations by inhibiting cytoplasmic cleavage has led us to compare the radiosensitivity of binucleate and mononucleate populations. The cell viability, after X-irradiation, was measured by counting the cells in definite areas every 24 h for 8 days; this method of survival evaluation had to be worked out since the glial cells do not form clones. Under these experimental conditions, binucleate and mononucleate cells show the same X-ray sensitivity. These results have been submitted for publication to "Archives de Biologie" under the title "Morphology and X-ray sensitivity of rat glial cells after cytochalasin B treatment". We presently attempt to find out if the presence of two nuclei in a same cytoplasm affects the cell radiosensitivity in other experimental conditions. This work is being performed on chinese hamster fibroblasts by comparing the survival curves of cytochalasin B treated and control cells. These curves have been obtained by the classical colony count method.

b. Radiosensitivity of cellular hybrids. Several synkaryons obtained by fusion of two mutant strains of chinese hamster fibroblasts (WG 3 H and A 23) have been isolated. One of the parental strain (WG 3H) is deficient for guanine-phosphoribosyltransferase and the other one (A 23) for thymidine kinase. The survival curves, after X-irradiation, and the karyotype of the parental strains and of their hybrids have been determined. To obtain D_{01} and n values, which are the characteristics of cell radiosensitivity, the experimental data obtained from colony counts are presently analyzed with a computer.

c. Effects of X-irradiation and dibutyryl adenosine 3', 5' monophosphate treatment on the cancerogenicity of glial cells. Injection of rat glial tumor cells in new-born rats provokes, within 12 days, the apparition of lethal tumors at the site of inoculation. Experiments have been undertaken to find out whether the modified 600 R irradiated cells (V. Heilporn et al. Radiat. Res. 54, 252, 1973) have retained their tumorigenicity or not. A single, morphologically modified cell has been cloned from a 600 R irradiated population with the aim of obtaining a cell line showing the same "differentiated aspect". These cells, if injected into new-born rats by subcutaneous inoculation, provoke the apparition of tumors; although the phenomenon is delayed (23 days instead of 12 days for non irradiated cells), these tumors are also lethal. On the other hand, glial tumor cells treated for 48 h with 1mM dibutyryl adenosine 3', 5', monophosphate exhibit very long processes rather similar to those induced by irradiation. This morphological modification is reversible, while the one induced by irradiation is stable. Dibutyryl adenosine 3'5' monophosphate treated cells injected to new-born rats in the way described above induce, within 12 days of lethal tumors, just as the untreated cells. Biopsies have shown, in all cases, that these tumors were malignant. Injection of culture medium alone and of non tumoral cells (chinese hamster fibroblasts) did not induce any tumor.

Publications.

V. Heilporn, A. Lievens, S. Limbosch, F. Zampetti, Int. J. Radiat. Biol. 23, 187 (1973).

F. Zampetti, G. Huez, J. Brachet. Exptl. Cell Res. 78, 383 (1973).
(This work has been realized in the "Laboratorio di Embriologia molecolare" (CNR, Arco Felice, Italy).

H. Alexandre, Y. Gerin, V. Heilporn, A. Lievens, S. Limbosch, F. Zampetti have participated at the "Workshop on cellular fusion" for the "Société belge de Biologie cellulaire" on March 1973, at the University of Brussels.

V. Heilporn, A. Lievens, S. Limbosch, F. Zampetti have participated at the "Workshop on approaches to asses the significance of experimental chemical carcinogenesis data for man" at the Université de Louvain.

Résultats du projet n° V

Chef du projet et collaborateurs scientifiques :
R. Jeener, J. Urbain, G. Urbain-Vansanten, M. Wikler,
C. De Vos-Cloetens, A. Van Acker, A. Vienne, N. Tasiaux,
C. Bruyns, R. Leuwenkroon, Ch. Wuilmart, H. Balluet.

Titre du projet : Immunochemical and immunogenetic investigations on the nature and activity of the antibody secreting cells observed in the irradiated animal after transplantation of lymphocytes from an immunized or non immunized donor animal.

- Previous results from this laboratory have shown that transfer of allogeneic lymphoid cells from hyperimmune rabbits hyperimmunized against TMV into irradiated rabbits bearing different allotypic markers on their immunoglobulins leads to the synthesis of immunoglobulins bearing allotypic markers of the recipients and reacting with antiidiotypic antisera raised against the donor antibody. These antiidiotypic antisera do not react against a large panel of other anti-TMV antibodies. Several new experiments have corroborated these findings. In addition, these results have been fully confirmed using in vitro systems. The stimulation of mixtures of cells from an hyperimmune donor (a_1/a_1) and from irradiated rabbits (a_3/a_3) with antigen has promoted the appearance of plasma cells secreting antibodies reacting with anti- a_3 and with a fluorescent antiidiotypic antiserum elicited against the antibody from the hyperimmunized rabbit (which is a_1/a_1). Radioimmunoassay methods have been applied to study in more details the sharing of idiotypic specificities between donor antibody and recipient antibodies. Such studies have shown that idiotypic specificities similar to those of the donor antibody are expressed in five out of six recipients. These idiotypic specificities are differently expressed in different recipients. In addition the presence of recipient allotypic specificities on such immunoglobulins has been confirmed using light chain markers. All these results can be interpreted according to one of the two following hypothesis : a) an information transfert between donor memory cells and precursors of antibody producing cells from the recipient ; b) from a variety of results it is now appearant that a given individual uses in its lifetime only a small part of the total antibody repertoire of the species. For example, different rabbits immunized against TMV synthesize antibodies with different idiotypic specificities. Following a germ line theory, it is possible that a given individual has all the genes corresponding to many or all idiotypic specificities of the species. Complex mechanism of activation and suppression would lead to the ex-

pression of only a few idiotypic specificities. Appropriate manipulation of the immune system would disturb this internal equilibrium. The introduction of numerous memory cells with immunoglobulin receptors with given idiotypic specificities into irradiated recipients would derepress host B cells able to express similar idiotypic specificities. (A. Van Acker, N. Tasiaux, G. Urbain-Vansanten, J. Urbain).

- Mice primed with TMV two months before received an intravenous injection of thymidine. This procedure labels a few percent of lymphoid cells which are called short lived lymphocytes. Lymphocytes bearing immunoglobulin receptors are not labelled. After two hours, these mice were killed, their spleen cells were removed, washed and injected into irradiated syngeneic mice. These mice received cold thymidine and TMV. Radioautography shows that anti-TMV plasma cells detected by immunofluorescence were labelled and therefore derive from the short lived lymphocytes bearing no immunoglobulin receptors by conventional immunofluorescence membrane techniques. Several experiments exclude the possibility of thymidine reutilization as an explanation for the results. All the results point out that plasma cells do not derive from the differentiation of resting lymphocytes with immunoglobulin receptors. (V. Hooghe, G. Urbain-Vansanten, C. Richard, J. Urbain).

- A series of experiments were undertaken to study the effects of irradiation on lymphocytes. It is usually assumed that irradiation kills dividing cells but many results point out that this view is too much simple. The universe of lymphocyte can be subdivided into two populations: B lymphocytes and T lymphocytes easily distinguished by some differentiation antigen. Preliminary results show that : normal spleen cells can be stimulated in vitro with anti-Ig. The stimulation index is greater after 10 days than after 3 days ; when these cells are irradiated before putting them in culture or taken from an irradiated rabbit, there is no increase of the stimulation index during the culture. These results are in agreement with the concept that cells dividing frequently and bearing no immunoglobulin receptors are the precursors of lymphocytes bearing receptors. (Ch. De Vos-Cloetens, J. Urbain, A. Van Acker).

- A restauration of immunological potentialities of irradiated mice occurs with time. However this restauration can be specifically inhibited if these irradiated mice are grafted with syngeneic spleen cells from a donor rendered tolerant to a given antigen. It seems therefore that tolerance cannot be due simply to a killing of "forbidden clones" but that some active mechanism of suppression operates. This mechanism must be due to the release of repressors from suppressing cells. (C. De Vos-Cloetens).

Séjours à l'étranger

Bourse accordées

J.URBAIN

- 8 Mars 1973 : Munich, Euratom- Conference on collaborative research.
Mai : 8-11 : 1 semaine, Paris, Colloque d'Oudin.
Juin : 1 semaine à Rome, sur invitation, Radiobiologie
Casaccia.
Juillet à octobre : MRC Cambridge, Laboratoire Dr Milstein,
Bourse FNRS.
Septembre : 1 semaine sur invitation, Université de Cambridge,
département de Pathologie.

Ch. DE VOS-CLOETENS

- 8-11 mai : Paris, Colloque International sur la génétique des
Immunoglobulines et de la réponse immunitaire.

Liste des Publications

- M. WIKLER : "Comparaison d'anticorps anticarbohydrates de streptocoques de microcoques produits simultanément par un même animal". Archives Internationales de Physiologie et Biochimie, 1973, 81, 213.
- C. DE VOS-CLOETENS, N.LAURENT : "Mise en évidence de l'existence de cellules tolérantes capables d'inhiber des cellules normales". Archives Internationales de Physiologie et Biochimie, 1973, 81, 179.
- J. URBAIN, A.VAN ACKER, N.TASIAUX, C. DE VOS-CLOETENS, G.URBAIN-VANSANTEN : "Interactions cellulaires dans le système immunocompétent et transfert d'information". Archives Internationales de Physiologie et Biochimie, 1973, 81, 204.
- G.URBAIN-VANSANTEN, A. VAN ACKER, J.URBAIN : "Transfert de cellules lymphoïdes primées à des animaux irradiés". Archives Internationales de Physiologie et Biochimie, 1973, 81, 206.
- A.VAN ACKER, R.LEUWENKROON, G.URBAIN-VANSANTEN, C. DE VOS-CLOETENS, J.URBAIN : "Evolution des propriétés des anticorps synthétisés au cours d'une immunisation". Archives Internationales de Physiologie et Biochimie, 1973, 81, 208.
- J. URBAIN : "Cellular recognition and evolution". Archives de Biologie, sous presse.
- A.VAN ACKER, G.URBAIN-VANSANTEN, C. DE VOS-CLOETENS, N.TASIAUX, J.URBAIN : "Synthesis of antibodies and immunoglobulins bearing recipient allotypic markers and donor idiotypic specificities in irradiated rabbits grafted with allogeneic hyperimmune cells." sous presse.
- A. VIENNE, M.WIKLER : "Isoelectric focusing of proteolytic fragments from rabbit antistreptococcal antibodies of restricted heterogeneity". Febs Letters, sous presse.
- WUILMART, Ch., WIJNS, Lode, URBAIN, J. : "Occurrence of linear and inverted duplications in protein evolution". Journal of Molecular Evolution, sous presse.
- R.JEENER : "The effect of tetranitromethane on the activity of anti-tobacco mosaic virus antibodies at various times after immunization". en préparation.

Chef des Groupes de Recherche :

Dr. Marc A. DALEBROUX, Fonctionnaire Scientifique aux
Communautés Européennes.

Thème Général du Contrat :

Etude des effets génétiques, aux échelons population et
cellulaire, des rayonnements ionisants :

- I. Effets des radiations ionisantes sur un caractère de
fitness important chez Habrobracon juqlandis.

- II. Réactions génétiques cellulaires aux rayonnements
ionisants chez Nicotiana tabacum.

■

■

■

PROJET N° I

Chef du projet : Dr. Marc A. DALEBROUX, Fonctionnaire Scientifique aux Communautés Européennes

Il existe en expérimentation, notamment dans celle concernée par les expériences traitant des effets des agents mutagènes en général, beaucoup de cas dans lesquels il est raisonnable d'ajuster des régressions polynomiales passant par l'origine. Il est alors nécessaire de décomposer la Somme des Carrés Traitements d'une analyse de variance en ses composantes adéquates. Le Laboratoire de Génétique Quantitative a élaboré la théorie permettant de le faire et en présente ci-après un résumé.

On considère la réponse d'une variable quantitative dépendante Y à un nombre n de niveaux, espacés de façon quelconque, d'une variable indépendante X , quantitative elle aussi, bien entendu. Sur r_i répétitions, on observe un total T_i de la variable dépendante correspondant à la valeur X_i de la variable indépendante. Il faut calculer les valeurs des coefficients orthogonaux $C_{k,i}$ affectant les totaux T_i dans l'évaluation de la réponse polynomiale de degré k ,

$$\sum_i C_{k,i} T_i ,$$

et introduire celle-ci dans l'analyse de variance en tant que composante simple (1 degré de liberté) de la Somme des Carrés Traitements, sous la forme

$$\frac{\left[\sum_i C_{k,i} T_i \right]^2}{\sum_i r_i C_{k,i}^2} .$$

On obtient le coefficient $C_{k,i}$ pour la réponse de degré k au niveau X_i de la variable indépendante X ,

$$C_{k,i} = X_i^k + \sum_{j=1}^{k-1} c_{k,k-j} X_i^{k-j} ,$$

après avoir résolu pour les $(k-1)$ $c_{k,k-j}$ le système de $(k-1)$ équations

$$\sum_i x_i^m C_{m,i} C_{k,i} = 0 \quad ; \quad m = 1, 2, \dots, k-1$$

•
• •

PROJECT N° 1

In experimental work, particularly that related to the investigation of the effects of mutagenic agents in general, there are many cases in which polynomial regressions through the origin should be fitted. It is then necessary to partition the Treatments Sum of Squares of an analysis of variance into its adequate components by means of orthogonal coefficients. This has been done for any number and spacing of levels of the independent variable X, and for any number of observations of the dependent variable Y at a given level of X.

PROJET N° II

Chef du projet : Dr. Hubert DULIEU, Chargé de Recherche au C.N.R.S.

Collaborateur scientifique : Dr. Marc A. DALEBROUX, pour la partie
Statistique et Génétique Statistique

Le Laboratoire de Génétique Quantitative a procédé à l'estimation, par la méthode du Maximum de Vraisemblance, des coefficients de sélection zygotique liés aux génotypes a_1^0/a_1^0 -/-, où

" a_1^0 " représente un série de délétions intéressant le locus $a_1^+ - a_1$ (cf. le rapport succinct 1972), et

"-" représente l'un quelconque des états géniques possibles au locus $a_2^+ - a_2$ homologue du locus $a_1^+ - a_1$.

Ces délétions proviennent de variations somatiques induites par rayonnement gamma.

Le Laboratoire de Génétique Quantitative a aussi considéré le problème de l'estimation des paramètres génétiques relative à un et deux loci pour lesquels les génotypes peuvent être identifiés sans erreur dans une population aux caractéristiques données. En effet, lorsqu'il est possible d'identifier et quantifier les génotypes des individus constituant une population déterminée, on peut procéder au traitement des données d'un échantillon proportionnel aux fréquences génotypiques dans la population afin d'obtenir des estimations directes des paramètres génétiques et des composantes de variabilité qui leur sont dues, sans passer par les covariances entre individus apparentés.

De telles données se traitent par les méthodes statistiques classiques appliquées aux échantillons. Les comparaisons entre les classes génotypiques fournissent des Carrés Moyens dont les espérances contiennent, bien entendu, une composante de variabilité due à l'erreur

d'échantillonnage en plus d'une composante de variabilité génétique imputable au type de comparaison. C'est ce qui différencie un échantillon de la population.

Les modèles génétiques utilisés sont classiques et traités comme des "modèles linéaires additifs fixés" de type factoriel. Ces modèles sont fixés, et non casuels, car tous les "traitements" (génotypes) sont présents dans l'expérience.

On considère une population en équilibre de Hardy-Weinberg. Dans le cas d'un seul locus à deux allèles de fréquences p et $q = 1-p$, l'expression phénotypique d'un individu est représentée par le modèle suivant dans un échantillon d'effectif N :

$$Y_{ijk} = \mu + \alpha_i + \alpha_j + \delta_{ij} + \epsilon_{ijk}$$

où

- μ est la moyenne générale de la population
- α_i est l'effet additif de l'allèle i ; $i = 1, 2$
- α_j est l'effet additif de l'allèle j ; $j = 1, 2$
- δ_{ij} est l'interaction de l'allèle i avec son homologue j .
C'est l'effet de dominance
- ϵ_{ijk} est l'effet-erreur casuel k dans la mesure du génotype ij ;
 - $k = 1, 2, \dots, p^2 N$ si $i = j = 2$
 - $k = 1, 2, \dots, pqN$ si $i \neq j$
 - $k = 1, 2, \dots, q^2 N$ si $i = j = 1$

Le tableau d'analyse de variance est le suivant :

Sources de Variation	dl	CM (Carrés Moyens)	E(CM)
Moyenne	1	-	
Additivité	1	CMA	$\sigma^2 + NA$
Dominance	1	CMD	$\sigma^2 + ND$
Erreur	$N - 3$	CME	σ^2

où

σ^2 est la variance erreur

A et D sont les composantes de variabilité génétique imputables à l'additivité et à la dominance, respectivement, pour la population considérée

On a donc les estimateurs des composantes de variabilité génétique et non génétique :

$$\hat{A} = \frac{CMA - CME}{N} ; \quad \hat{D} = \frac{CMD - CME}{N} ; \quad \hat{\sigma}^2 = s_e^2 = CME$$

$\hat{A} + \hat{D} = \hat{G}$, estimateur de la composante de variabilité génétique totale.

Finalement, on estime l'héritabilité au sens étroit (h_E^2) et l'héritabilité au sens large (h_L^2) pour le caractère concerné par le locus dans les conditions spécifiées :

$$\hat{h}_E^2 = \frac{\hat{A}}{\hat{G} + s_e^2} \quad \text{et} \quad \hat{h}_L^2 = \frac{\hat{G}}{\hat{G} + s_e^2}$$

Une application pratique a été faite sur N. tabacum par le Laboratoire de Mutagenèse de la Station (H. DULIEU), qui prépare pour le moment une application, toujours sur tabac, d'un modèle à deux loci indépendants et à deux allèles chacun. Les fréquences géniques aux deux loci sont p et q = 1-p d'une part, et u et v = 1-u d'autre part. Dans un échantillon d'effectif N, l'expression phénotypique d'un individu tiré d'une population en équilibre de Hardy-Weinberg est représentée par le modèle suivant :

$Y_{ijklm} = \mu$	moyenne de la population
$+ \alpha_i + \alpha_j + \delta_{ij}$	effets additifs et de dominance au locus I
$+ \beta_k + \beta_l + \zeta_{kl}$	effets additifs et de dominance au locus II
$+ (\alpha\beta)_{ik} + (\alpha\beta)_{il} + (\alpha\beta)_{jk} + (\alpha\beta)_{jl}$	effets d'interaction entre les effets additifs au locus I d'une part et au locus II d'autre part
$+ (\alpha\zeta)_{ikl} + (\alpha\zeta)_{jkl}$	effets d'interaction entre les effets additifs au locus I et l'effet de dominance au locus II
$+ (\delta\beta)_{ijk} + (\delta\beta)_{ijl}$	effets d'interaction entre l'effet de dominance au locus I et les effets additifs au locus II
$+ (\delta\zeta)_{ijkl}$	effet d'interaction entre les effets de dominance au locus I d'une part et au locus II d'autre part
$+ \epsilon_{ijklm}$	effet-erreur casuel m dans la mesure du génotype ijkl

où

$i, j, k, l = 1, 2$

$m = f_{ijkl} N$; f_{ijkl} est la fréquence du génotype ijkl dans la population considérée.

Les estimateurs des effets géniques particuliers dans les conditions de la population étudiée s'obtiennent bien entendu, pour l'un et l'autre modèle, par la résolution des équations normales.

Le tableau d'analyse de variance se présente comme suit :

Sources de Variation	dl	CM (Carrés Moyens)	E(CM)
Moyenne	1	-	
Additivité I	1	CMA _I	$\sigma^2 + NA_I$
Dominance I	1	CMD _I	$\sigma^2 + ND_I$
Additivité II	1	CMA _{II}	$\sigma^2 + NA_{II}$
Dominance II	1	CMD _{II}	$\sigma^2 + ND_{II}$
Add. I x Add. II	1	CMAA _{I,II}	$\sigma^2 + NAA_{I,II}$
Add. I x Dom. II	1	CMAD _{I,II}	$\sigma^2 + NAD_{I,II}$
Dom. I x Add. II	1	CMDA _{I,II}	$\sigma^2 + NDA_{I,II}$
Dom. I x Dom. II	1	CMDD _{I,II}	$\sigma^2 + NDD_{I,II}$
Erreur	N - 9	CME	σ^2

Les estimateurs des composantes de variabilité s'obtiennent de la même façon que dans le premier cas :

$$\hat{A}_I = \frac{CMA_I - CME}{N}, \dots, \hat{DD}_{I,II} = \frac{CMDD_{I,II} - CME}{N}$$

$$\hat{\sigma}^2 = s^2_e = CME$$

d'où l'on tire :

Estimateur de la Composante de Variabilité Génétique imputable à	
Additivité	$\hat{A} = \hat{A}_I + \hat{A}_{II}$
Dominance	$\hat{D} = \hat{D}_I + \hat{D}_{II}$
Additivité x Additivité	$\hat{AA} = \hat{AA}_{I,II}$
Additivité x Dominance	$\hat{AD} = \hat{AD}_{I,II} + \hat{DA}_{I,II}$
Dominance x Dominance	$\hat{DD} = \hat{DD}_{I,II}$

La composante de variabilité génétique totale est :

$$\hat{G} = \hat{A} + \hat{D} + \hat{AA} + \hat{AD} + \hat{DD}$$

Finalement, on estime l'héritabilité au sens étroit et au sens large pour le caractère concerné par les deux loci dans les conditions spécifiées :

$$\hat{h}_E^2 = \frac{\hat{A}}{\hat{G} + s_e^2} \quad \text{et} \quad \hat{h}_L^2 = \frac{\hat{G}}{\hat{G} + s_e^2}$$

REMARQUES

(1) Lorsqu'on dit que deux loci sont indépendants, cela ne signifie pas nécessairement, du point de vue probabiliste, qu'ils ne sont pas liés sur le même chromosome. L'indépendance signifie simplement que, dans la table génotypique 3 x 3, une fréquence donnée est égale au produit des deux fréquences marginales correspondantes. S'il n'en était pas ainsi, les effets des deux loci seraient liés par une corrélation, et la variance totale ne serait plus égale à la somme des variances des effets marginaux et de leurs interactions éventuelles. En conséquence, si les deux loci considérés sont effectivement liés, il faut qu'ils soient en "équilibre de linkage". De plus, en cas de liaison, il faut, pour que la table 3 x 3 soit valable, que les génotypes doubles-hétérozygotes en couplage et en répulsion soient équivalents.

(2) A chacun des deux loci, il n'est pas nécessaire que les fréquences génotypiques soient en équilibre de Hardy-Weinberg. Ce dernier cas a été choisi tant parce qu'il facilite la manipulation des équations normales que parce qu'il concerne l'application que le Laboratoire de Mutagenèse veut en faire sur N. tabacum.

■
■ ■

PROJECT N° II

When the genotypes of the individuals in a population can be identified and thereafter quantified, direct estimates of the genetic parameters and of the genetic variability components can be obtained from a sample proportional to the population genotypic frequencies. In such a situation, covariances among relatives are, of course, not needed. The Quantitative Genetics Laboratory has worked out the theory (i) for one locus and two alleles with frequencies p and $q = 1-p$, and (ii) for two loci with two alleles each, the frequencies of which are p and $q = 1-p$ at one locus, and u and $v = 1-u$ at the other.

In both cases the population was assumed to be in random mating conditions. For the two-locus case, the loci were supposed to be independent in frequencies of occurrence. This implies that the loci are either located on different chromosomes or in linkage equilibrium. This condition is necessary for the exact partitioning of the SS of the 3×3 genotypic table into the sum of the SS's for the marginal effects and their eventual interactions. Furthermore, when linkage is present, the 3×3 genotypic table is valid if the coupling and repulsion double heterozygotes are equivalent. Of course, the least squares estimates of the particular genic effects in the conditions of the population studied can be obtained by solving the normal equations.

REMARQUE

Pour des questions d'équilibre budgétaire à l'Institut National de la Recherche Agronomique d'une part et à la Commission des Communautés Européennes d'autre part, le Laboratoire n'a pas pu engager le personnel technique nécessaire à la conduite d'expériences de taille raisonnable. Cette remarque concerne la période s'étendant d'octobre 1972 à octobre 1973, qui couvre donc pratiquement l'entièreté de l'exercice écoulé. Cependant, du travail de recherche théorique a été fait en relation avec les sujets proposés dans le thème général du contact.

P U B L I C A T I O N S
=====

DALEBROUX M. Régressions Polynomiales par l'Origine - Analyse de
Variance par la Méthode des Coefficients Orthogonaux.
(proposé à l'Editeur).

DALEBROUX M. et H. DULIEU. Estimation aux Moindres Carrés des
Effets Géniques chez un Organisme Diploïde - Un
Locus à Deux Allèles - Application à N. tabacum.
(proposé à l'Editeur).

■

■ ■

RELAZIONE DI ATTIVITA' 1973

Associato della Commissione: Università di Pavia

Gruppo Euratom - Istituto di Biologia Generale. Facoltà di Medicina

N° del contratto: 112-72-1 BIOD

Capo del gruppo di ricerca: Prof. M. Fraccaro

Tema generale del contratto: Studi sulla natura, dinamica e modalità di segregazione dei riarrangiamenti cromosomici spontanei ed indotti.

Breve descrizione generale dei lavori compiuti.

Il lavoro si è concentrato su due linee principali:

- 1) Sono stati esaminate in dettaglio due linee cellulari stabilizzate in vitro, entrambe di origine umana, per i seguenti parametri:
 - a) identificazione dei singoli cromosomi con le tecniche della fluorescenza e dopo denaturazione e rinaturazione del DNA e colorazione con Giemsa per determinare quali cromosomi sono presenti come normali e quali dovuti a riarrangiamenti.
 - b) evoluzione nel tempo del rapporto tra cromosomi normali e anormali.
- 2) Ricerca di eventuali rotture preferenziali nelle cellule della linea stabilizzata CHEF 125 irradiate con radiazione UV.

Descrizione dei risultati

- 1) a) Linea cellulare EUE originata nel 1958 da un embrione umano. Questa linea ha dimostrato, durante la presente ricerca svoltesi tra la fine del 1972 e il mese di Dicembre 1973 due classi modali, una a 62 cromosomi (A) ed una a 63 cromosomi (B). La proporzione di cromosomi normali in 15 cellule esaminate in dettaglio cromosoma per cromosoma in ciascuna delle classe A e B è di 0,47 e 0,46 rispettivamente.

I cromosomi 1, 4 e 9 sono sempre assenti. Presenti singolarmente sono i cromosomi 2, 3, 5, 11, 13, 15, 20 e 22 mentre i numeri 7, 10, 12, 14, 18, 19 e 21 sono (nella maggioranza delle cellule) presenti in duplicato. Trisomici sono sovente i cromosomi 6, 16 e 17. Ventidue cromosomi "nuovi" sono consistentemente presenti in tutte le cellule analizzate. Di questi, 15 sono identificabili nella loro probabile origine (traslocazione, delezione, inversione) e ben 7 comprendono segmenti del cromosoma No. 1. Gli altri 7 cromosomi nuovi, pur essendo presenti in tutte le cellule non sono risultati identificabili. L'analisi dettagliata dei vari tipi di riarrangiamenti nei quali è implicato il cromosoma No. 1 (e altri) indica che questo si rompe preferenzialmente in corrispondenza delle bande C, cioè di quelle regioni paracentromeriche che si presume siano composte da DNA ripetitivo.

b) Linea cellulare Mel 41, originata da un melanoma umano. Questa linea ha una moda cromosomica principale a 60 cromosomi ed una seconda moda a 44. Nelle cellule a 60 cromosomi la proporzione dei cromosomi normali è di 0,47, simile cioè a quella della linea EUE. Consistentemente assenti sono i cromosomi 3, 8 e 20. I cromosomi 1, 4, 5, 10, 11, 14, 15, 16, 21 e 22 sono presenti in singola coppia mentre i rimanenti (2, 6, 7, 9, 12, 13, 17, 18, 19) sono presenti in duplicato. L'identificazione della origine dei cromosomi "nuovi" è tutt'ora in corso. Nell'ultima fase della ricerca le cellule a 44 cromosomi sono in aumento relativo nella popolazione cellulare delle colture massive. E' di particolare interesse l'osservazione che il rapporto cromosomi normali/anormali nelle cellule della linea modale a 44 non è uguale a quello delle cellule a 60 cromosomi ma i cromosomi normali sono meno di 1/3 degli anormali. Si può pertanto fare l'ipotesi che le cellule a 44 originino per perdita preferenziale di cromosomi normali.

2) Irradiazione UV

Le cellule della linea CHEF 125 di origine da embrioni di hamster cinese sono state irradiate con 400 W/cm^2 per tempi compresi tra 30 e 150 sec e susseguentemente incubate a 37°C per tempi tra 1 e 4 ore prima della esecuzione dei preparati cromosomici. La maggior frequenza di rotture cromosomiche (3,4 per cellula) è stata osservata dopo irradiazione di 60 sec e con tempo di recupero di 4h. In questa prima serie di esperimenti è stata riscontrata la costante assenza della parte terminale del braccio lungo del cromosoma No. 4 che è caratterizzata da intensa fluorescenza. Questo indica un punto preferenzialmente molto sensibile alla radiazione ultravioletta.

General outline

The research work in 1973 was centered in two main lines:

- 1) Detailed analysis of two established cell lines in vitro, both of human origin, for the following parameters:
 - a) precise identification of each individual chromosome with the fluorescence and Giemsa techniques to classify them as normal and "new" chromosomes originating from re-arrangements.
 - b) temporal changes in the proportion of the two types of chromosomes.
- 2) Search for eventual preferential chromosome breakage in cells of the established Chinese hamster cell line CHEF 125 after UV irradiation.

Results

- 1) a) Cell line EUE derived in 1958 from a human embryo. During the investigation (end of 1972 - December 1973) this cell line had two modal chromosome classes, one with 62 (A) and one with 63 (B) chromosomes. The proportion of normal chromosomes in the 15 cells in which each chromosome was examined in great detail was 0.47 in the cells of group A and 0.46 in those of group B. Chromosomes 1, 2 and 9 are consistently missing in all cells. Chromosomes 2, 3, 5, 11, 13, 15, 20 and 22 are present in single copy while numbers 7, 10, 12, 14, 18, 19 and 21 are (in most cells) present in duplicate. Chromosomes 6, 16 and 17

are in most cells trisomic. Twentytwo "new" chromosomes are consistently present in each of the cells examined. Of these, 15 were identified as to their origin (translocation, deletion, inversion) and 7 of them include various segments of chromosome No. 1. The other 7 "new" chromosomes, while also present in each of the cells, were not identified. The detailed analysis of the various types of rearrangements in which chromosome No. 1 (and others) is involved indicates that this chromosome breaks preferentially in correspondence of the C bands, i. e. those regions which are composed of repetitive DNA.

b) Cell line Mel 41, derived from a human melanoma. This line has a major modal class at 60 and a second one at 44 chromosomes. In the cells with 60 chromosomes the proportion of normal chromosomes is 0.47, similar to that of the EUE line. Chromosomes 3, 8 and 20 are consistently missing. Chromosomes 1, 4, 5, 10, 11, 14, 15, 16, 21 and 22 are always present in a single copy while chromosomes 2, 6, 7, 9, 12, 13, 17, 18 and 19 are present in duplicate. The detailed identification of the origin of the "new" chromosome is still in progress. During the last period of the research the cells with 44 chromosomes are relatively increasing their proportion in the cell population maintained in vitro by mass cultivation. Of special interest is the observation that the ratio normal/abnormal chromosomes in the cells with 44 chromosomes is not the same as that in the cells with 60 chromosomes, but the normal chromosomes are less than 1/3 of the abnormal ones. This indicates that the cells with 44 may originate by preferential loss of normal chromosomes.

2) UV radiation

Cells of the CHEF 125 cell line were irradiated with $400\mu\text{W}/\text{cm}^2$ for lapses between 30 and 150 sec and subsequently incubated at 37°C for times between 1 and 4 hours before chromosome preparations were made. The highest frequency of chromosome breakage (3.4 per cell) was observed after exposure for 60 sec and with recovery time of 4 hours. In this series of preliminary experiments it was observed the consistent loss of the terminal portion of the long arm of chromosome No. 4, a portion which is intensely fluorescent. This indicates a preferential point very sensitive to UV radiation.

KURZZEITWIRKUNGEN (AKUTES STRAHLENSYNDROM UND SEINE BEHANDLUNG)

SHORT-TERM EFFECTS (ACUTE IRRADIATION SYNDROME AND ITS TREATMENT)

EFFETS A COURT TERME (SYNDROME AIGU D'IRRADIATION ET DE SON TRAITEMENT)

Weitere Forschungsarbeiten zu diesem Thema werden auch in folgenden Jahresberichten beschrieben:

Further research work on these subjects will also be described in the following annual reports:

D'autres travaux sur ce thème de recherche sont également décrits dans les rapports annuels suivants:

099-BIAB ULB Bruxelles (Brachet)

095-BIOB CEN Mol (Maisin)

Vertragspartner der Kommission:

Assoziationsvertrag
zwischen
der Europäischen Atomgemeinschaft
und

der Association Claude-Bernard
dem Istituto di Ricerche Farmacologiche "Mario Negri"
dem Land Baden-Württemberg
der Organisatie voor Toegepast Natuurwetenschappelijk
Onderzoek voor Gezondheid (TNO) und
der l'Université Libre de Bruxelles

Nr. des Vertrages: 088 - 72 - 1 BIA C

Leiter der Forschungsgruppen:

- Claude-Bernard Association, Institut de Cancérologie
et Immunogénétique, Villejuif:
Prof. Dr. G. Mathé
- Istituto di Ricerche Farmacologiche "Mario Negri", Milano:
Prof. Dr. S. Garattini
- Universität Ulm, Abteilung für Klinische Physiologie, Ulm:
Prof. Dr. T. M. Fliedner
- Radiobiological Institute TNO, Rijswijk:
Prof. Dr. D. W. van Bekkum
- Institut Jules Bordet, Bruxelles:
Prof. Dr. H. Tagnon

Allgemeines Thema des Vertrags:

Consequences of Radiation Exposure : Prevention and Treatment
of Pathological Effects

Allgemeine Darstellung der durchgeführten Arbeiten:

The collaborative research work of this association contract
No. 088 - 72 - 1 BIA C in 1973 is concerned with the continuation
of previous work - outlined in the Euratom Reports 1971 (EUR
4830 d-f-i-n-e) and 1972 (EUR 4864 d-e-f-i-n) - in 3 areas:

1. Evaluation of damage by ionizing radiation to various organs
but mainly to the hematopoietic tissue.
2. Design and perfection of treatment of bone marrow failure
as seen after whole body irradiation.
3. Selected studies on the physiology and pathophysiology of
cell systems relevant to the understanding of radiobiological
processes.

As far as point 1 of this program is concerned, work related
to the evaluation of damage by ionizing radiation to various

organs has been carried out particularly by the Ulm-Group. Here, the studies concentrate on the biological effects of tritium - a radionuclide of paramount importance in nuclear power reactors. The studies so far concentrate on the biological effectiveness of tritium incorporated as tritiated thymidine as compared to tritiated water, and the comparison of these effects to external x-irradiation (as a reference system). The cell system studies are those of the hematopoietic organs, the ovaries and more recently the testes. It will be necessary in the future to establish quantitative data as to the mechanisms behind the observation that tritiated thymidine is much more effective in producing certain biological consequences than when the tissue is exposed to equal amounts of tritium, and it is concluded, that the final position of the tritium compound in the cell structure is an important factor in the observed differences.

The principal effort of this association contract is the design and perfection of the treatment of bone marrow failure after radiation exposure.

In 1973, work was performed at the clinical and experimental level in 2 major areas : part of the work was directed to diminish and eliminate the risk of bacterial infection as a consequence of radiation or drug induced granulocytopenia. The elimination of the microbiological flora in mammals proved to be of importance not only to prevent manifestation of bacterial infection, but also to diminish incidence and severity of graft-versus-host disease after bone marrow transfusion in irradiated hosts. The Ulm-Group continued the effort to eliminate the bacterial flora by means of antibiotic treatment and maintenance of the gnotobiotic state in a germfree environment within the EORTC Gnotobiotic Project Group, comprising efforts in about 10 clinical centers in Europe.

The group in Villejuif laid major emphasis on the improvement and extension of bone marrow therapy in aseptic environments. Preparations were made to initiate within the association contract a collaborative project on the improvements of methods

to store platelets at ultra-low temperatures. This is important with respect to the fact that bleeding complications after irradiation are largely due to thrombocytopenia and need to be treated by histocompatible platelet transfusions. In order to have sufficient numbers of histocompatible platelets, cryopreserved platelet banks need to be established eventually.

The second area of work aimed at the improvement of treatment of bone marrow failure is that of bone marrow or hemopoietic stem cell transfusion.

In man, bone marrow transfusions were performed by the groups in Villejuif and in Ulm to combat hemopoietic failure as a consequence of drug treatment. Emphasis was in both groups on the problem of the handling of graft-versus-host disease not only by immune-suppression through agents tested experimentally by the groups in Rijswijk and Milano but also by diminution of the microbial flora by aseptic environments and (in Ulm) by the administration of non-resorbable antibiotics.

At the experimental pre-clinical level, studies on the restoration of hemopoietic activity by means of stem cell and/or bone marrow transfusion were performed in monkeys (Rijswijk) and in dogs (Ulm and Rijswijk).

The Rijswijk group concentrated in 1973 on the problem of histocompatibility typing in monkeys with the ultimate objective of identifying factors which determine development and severity of graft-versus-host disease following bone marrow grafting. Both the groups, in Rijswijk and in Ulm, made concerted efforts to study the histocompatibility systems in dogs, using serological typing methods as well as mixed lymphocyte culture approaches.

While the Rijswijk group concentrated on the question of bone marrow transplantation in dogs, the severity and pathogenesis of graft-versus-host disease in relation to the degree of histocompatibility between donor and host, the Ulm group continued the effort to accumulate blood stem cells and use them to restore hemopoiesis after whole body irradiation.

In Ulm, the first successful long term takes were observed in 1200 rad whole body irradiated dogs after transfusion of cryo-preserved blood leukocytes as a stem cell source and in which the graft-versus-host reaction was overcome.

The group in Milano concentrated its efforts on the study of radiomimetic immune-depressants, which may form the basis both for a better therapeutical use of these agents and an understanding of their multifaceted interaction with the organisms. This work is a basic contribution to the handling of graft-versus-host reaction following hemopoietic stem cell transplantation.

All groups carried out complementary research in rodents to study pathogenetic mechanisms of bone marrow failure and its treatment by marrow transfusion.

Important contributions in this area come from studies identifying functionally as well as morphologically those cells that are responsible for the restoration of radiation damaged hemopoiesis : the stem cells. Tests to identify such cells in marrow and blood suspensions include the agar-colony-technique (CFU-c test) as well as the millipore-chamber system in addition to the previously employed spleen-colony-assay (CFU-s test). In this area, studies on the interrelationship of the various hemopoietic stem cell compartments (committed and uncommitted compartments) have been performed, utilizing the hypertransfused, germfree mouse as a successful test system to manipulate stem cell differentiation. Of importance in this basic area has been the investigation of the characterization of fetal and neonatal stem cell compartments as a basis to study the regulation of hemopoietic cell kinetics.

The cooperative work of the partners of this contract is promoted and catalysed by the fact that they form the core membership of both the European Late Effects Project Group (EULEP) and the European Organization for Research on Treatment of Cancer (EORTC) with its Research Clubs and Project Groups (i.e. EORTC Stem Cell

Club, EORTC Gnotobiotic Project Group). An interesting experience has been the organization of a Seminar on Research Planning Methodology held in July 1973 at the Schloss Reisenburg which may well prove to be important for the improvement of scientific cooperation and its development in Europe.

Contractant de la Commission: Association Claude-Bernard,
Institut de Cancérologie et d'Immunogénétique, Hôpital
Paul Brousse, I4 & I6, Av. P.V. Couturier, 94.800 - VILLEJUIF

N° du contrat: 088-72-1-BIAC

Chef du Groupe de Recherche: Professeur Georges MATHE

Thème général du contrat: Traitement des états pathologiques secondaires à l'irradiation.

Description générale succincte des travaux réalisés.

Nous avons poursuivi l'étude thérapeutique des états pathologiques secondaires à l'irradiation: les aplasies de la moelle osseuse et les leucémies.

Dans le cas des aplasies, nous avons travaillé expérimentalement et cliniquement sur le contrôle de la GVH, après greffe de moelle, chez les radiochimères, grâce à la découverte des chalcones lymphocytaires et grâce à l'emploi de l'antigène d'histocompatibilité soluble.

Dans le cas des leucémies, la chimiothérapie s'étant avérée pratiquement incapable de "tuer la dernière cellule" puisqu'elle obéit à la cinétique de premier ordre, nous avons introduit la notion d'immunothérapie active qui pourra peut-être s'étendre à l'immunoprévention des leucémies et nous avons choisi les conditions techniques des immunothérapies adoptive, passive et surtout active.

Notre screening des adjuvants de l'immunité est actuellement une référence.

Résultats du projet n° 1

Chef du projet et collaborateurs scientifiques:
Professeur G. MATHE.

Titre du projet: Traitement des états pathologiques secondaires à l'irradiation.

Description des résultats.

L'irradiation entraîne deux sorte d'états pathologiques: l'aplasie de la moelle osseuse, complication constante d'une irradiation aigue et massive, et la leucémie, complication rare mais pouvant survenir aussi bien après une irradiation aigue qu'après une irradiation chronique. Pour les aplasies de la moelle osseuse, nos travaux ont porté sur la prévention et le traitement de la réaction du greffon contre l'hôte et de la maladie secondaire; pour la leucémie, ils ont porté sur la greffe de moelle osseuse et l'immunothérapie. Des recherches en immunologie fondamentale ont dû être menées parallèlement à nos travaux de recherche appliquée.

Immunologie fondamentale: chalone lymphocytaire.

1. Chalone lymphocytaire isolée du thymus: étude de sa spécificité et de son mécanisme d'action.

Facteur lymphocyto-inhibiteur isolé du thymus. Effets immunosuppresseurs dans "Chalone-Concepts et recherches actuelles".

N. KIGER, I. FLORENTIN et G. MATHE (National Cancer Institute Monograph., 1973, 38, I35.

Spécificité envers les lymphocytes T d'un facteur lymphocyto-inhibiteur isolé du thymus.

I. FLORENTIN, N. KIGER et G. MATHE (Europ. J. Immun. sous presse)

Une chalone est une sécrétion interne qui a pour fonction le contrôle, par inhibition, de l'activité mitotique du tissu qui la synthétise.

Une chalone lymphocytaire a été isolée du thymus et a été purifiée par chromatographie sur DEAE cellulose ou par filtration sur Sephadex G 75.

Il a été montré, l'an passé, que cette substance inhibe le développement de réactions immunitaires par l'intermédiaire d'une action sur les lymphocytes T seuls (tableau 1).

La spécificité tissulaire de la chalone lymphocytaire a été confirmée par le fait qu'elle est incapable d'inhiber: a) in vivo, le développement de colonies spléniques résultant de la différenciation et de la prolifération d'éléments des lignées granulocytaire, érythrocytaire et mégacaryocytaire, b) in vitro, la synthèse d'ADN dans des tranches de foie en régénération.

In vitro, la chalone lymphocytaire inhibe très efficacement et avec la même intensité, la synthèse d'ADN dans des sous populations de lymphocytes T représentant divers stades dans leur différenciation et leur maturation, s'effectuant en absence ou sous l'influence d'une stimulation, par la phytohéماغglutinine. Elle est par contre peu efficace sur la synthèse d'ADN spontanée dans des cellules spléniques dépourvues de lymphocytes T et est sans aucune action quand les lymphocytes B, dans cette même population sont préalablement activés par le lipopolysaccharide.

Une étude cinétique de l'action de la chalone sur la synthèse d'ADN dans des thymocytes de souris a révélée que cette action est très rapide (50% d'inhibition en moins de cinq minutes) et est totalement réversible.

L'ensemble de ces résultats apporte des arguments nouveaux de poids, en faveur: a) de l'identité de la substance inhibitrice extraite du thymus avec une chalone lymphocytaire, b) de la spécificité de cette chalone envers les lymphocytes T, c) de son intérêt en tant qu'immunosuppresseur physiologique.

2. Immunogénétique et transplantations

2,1 Antigènes d'histocompatibilité

Etude de l'expression des diverses spécificités H-2 à la surface de cellules lymphoïdes de souris de la série B 10 et de leurs hybrides.

Etude quantitative des antigènes d'histocompatibilité à la surface des cellules normales et leucémiques de souris. II. Variations quantitatives de l'expression de diverses spécificités H-2 chez les cellules lymphoïdes de lignées co-isogéniques B 10 et leurs hybrides.

R. MOTTA, L. PHALENTE et C. LEDOUCEN (en préparation).

Chez la Souris, les antigènes H-2 sont sous la dépendance de la "région H-2" qui est composée de deux sous-régions: "D" et "K". On admet actuellement que chacune de ces sous-régions détermine, à la surface de la cellule, la présence d'un type de molécule qui porte, soit les antigènes de la région D, soit les antigènes de la région K.

Cullen S.E. et coll. (Proc. Nat. Acad. Sci. USA, 1972, 69, 1394) ont montré que, dans les cellules d'un animal hybride où chaque région K et chaque région D spécifie des antigènes différents, on trouve 4 types moléculaires différents correspondant chacun à une région D ou K.

Dans le but de contribuer à l'étude du déterminisme génétique des différentes spécificités H-2, nous avons, par absorption quantitative d'antisera, comparé la quantité d'antigènes H-2 à la surface de cellules lymphoïdes de souris des lignées co-isogéniques: B 10 D2, B 10 M, B 10 R2, B 10 R5 et B 10 Br, ainsi que tous les hybrides entre ces lignées.

L'expression des spécificités 23-11-25, 1, 5, (du groupe d'inclusion K) et de la spécificité 3 (du groupe d'inclusion D) a été étudiée systématiquement chez tous les hybrides et leurs parents.

Un certain nombre d'observations principales concernant les résultats peuvent être faits: a) il n'y a pas de corrélation entre l'expression des diverses spécificités du "groupe K" d'une part, et la spécificité 3 d'autre part. Par exemple l'hybride F1, B 10 R/5xB 10 R2 exprime la spécificité 5 à un niveau intermédiaire entre celui

des parents (75 contre 100 et 30) tandis que la spécificité 3 est 6 fois plus exprimée que chez les parents (600 contre 100 et 100), b) l'expression d'une spécificité chez un hybride peut différer très significativement de la moyenne des deux parents, c) l'expression relative des différentes spécificités du groupe d'inclusion K peut varier d'un hybride à l'autre, bien qu'elles soient codées par le même "allèle H-2". Par exemple, l'hybride B10R5 x B10BR montre une augmentation relative du groupe de spécificités 23-11-25 alors que la spécificité 1 est à un niveau intermédiaire entre celui des parents.

L'opinion générale était, jusqu'à récemment, que les gènes codant pour les antigènes de transplantation étaient codominants tant sur le plan qualitatif que sur le plan quantitatif, c'est à dire, que les antigènes présentés par un hybride étaient qualitativement la somme de ceux des parents et présents en quantité intermédiaire aux quantités trouvées chez les parents.

Les quelques observations qui précèdent tendent à faire penser, en fonction des différentes combinaisons des allèles H-2, que des modifications peuvent intervenir soit dans l'organisation des différentes spécificités au niveau de la molécule qui les porte, soit dans la présentation de la molécule au niveau de la membrane. Dans ce deuxième cas, on devrait admettre que les différentes dispositions des molécules portant les spécificités H-2 peuvent interférer avec l'accessibilité aux anticorps de certaines de ces spécificités.

Comme nous avons étudié des combinaisons génétiques entre lignées ne différant entre elles que par le locus H-2 et les régions immédiatement voisines, on devra admettre que ce sont des gènes très liés à H-2 qui interviennent dans ces modifications. Il n'est pas prouvé que des gènes non génétiquement liés à H-2 ne puissent pas intervenir dans l'expression de cette région.

2,2 Immunodépression

2,21 Immunodépresseurs chimiques - R. HUCHET (en préparation)

Tolérance induite par la cyclophosphamide.

La tolérance, à différents types d'antigènes, induite grâce à la cyclophosphamide administrée chez la Souris, à la dose de 100mg/kilo, le lendemain de l'injection de l'antigène, a permis d'analyser la sensibilité à cette drogue des différents types de

cellules (T et B) impliqués dans la réponse immunitaire.

Il a pu être établi, en utilisant la DNP Flagelline qui est un antigène thymo-indépendant pour la réponse IgM que l'on pouvait induire la tolérance au niveau des cellules B de type IgM.

D'autre part, l'induction de la tolérance à la globuline de poulet (γ GP), testée par la réponse anti DNP à la DNP γ a mis en évidence l'atteinte des cellules T dites "Helper". Enfin, on a pu montrer que la tolérance à la DNP γ GP portait à la fois sur les cellules T dites "Helper" et les cellules B de type IgM. Par contre, l'intégrité des cellules de type IgG était respectée.

2,22 Le sérum anti-lymphocytaire (SAL)

Préparation de SAL à partir de cultures de lymphocytes humains.

D. BELPOMME, D. GRANDJON, E. DU RUSQUEC, P. TROLARD et J. CHOAY (à paraître)

Depuis 1970, plusieurs SAL ont été préparés en collaboration avec les laboratoires Choay en utilisant les cellules de nombreuses lignées permanentes de type lymphoïde, comme source antigénique.

Les cellules sont cultivées en masse à l'aide de flacons "spinners". L'immunisation des chevaux est effectuée à l'aide de préparations cellulaires contenant un mélange à partie égale de 10 lignées permanentes préalablement sélectionnées. Les injections sont faites par voie sous-cutanée, à dose hebdomadaire croissante jusqu'à un total de $100 \cdot 10^9$ cellules/cheval.

Les SAL ainsi obtenus possèdent une activité anti-erythrocytaire et antiplaquettaire nulle. A l'inverse, ces SAL sont nettement cytotoxiques in vitro, et possèdent un titre d'inhibition des rosettes spontanées de l'ordre de 1/1000.

Dans un travail récent, en coopération avec le Docteur H. BALPER (Rijswijk, Pays Bas), on a effectué la survie des allogreffes de peau, chez le Singe conditionné par ces SAL: la durée des allongements est augmentée du 1/3 environ par rapport aux témoins.

Récemment, d'autres SAL ont été préparés chez le Cheval en utilisant le surnageant des cultures comme source antigénique. Les résultats sont très encourageants, (cytotoxicité plus importante, prolongation des allogreffes chez le Singe, supérieure à celle obtenue avec les SAL fabriqués à partir des préparations cellulaires).

L'utilisation clinique de ces SAL, préparés à partir de cultures a donné lieu à une parfaite tolérance, malgré des doses d'administration très supérieures à celles habituellement utilisées. Des résultats intéressants ont été, en particulier, obtenus dans le traitement des hépatites chroniques actives qui résistaient aux corticoïdes et à l'Azathioprine (travail effectué en collaboration avec le Professeur C. BÉTOURNE, Hôpital Ambroise Paré, Paris).

2,22 Le sérum antilymphocytaire (SAL) (Suite)

Variations de l'expression des antigènes de membrane de cellules en culture.

C. ROSENFELD, J.F. DORE, C. CHOQUET, A.M. VENUAT, E. AJURIA, L. MARHOLEV et J.P. WASTIAUX. (Transplantation, 1973, 16, 279).

Variations au cours du cycle cellulaire de l'expression des antigènes de membranes décelés par des globulines antilymphocytes après synchronisation des cellules d'une lignée lymphoblastoïde humaine.

C. ROSENFELD, J.F. DORE, C. CHOQUET, A.M. VENUAT, J.P. WASTIAUX, C. GUIBOUT et J.L. PICO (C.R. Acad. Sci., sous presse).

Augmentation de l'expression antigénique des membranes de leucocytes humains marqués par GAL.F. en fonction du temps en culture.

C. ROSENFELD, J.F. DORE, C. CHOQUET, A.M. VENUAT, L. MARHOLEV, J.P. WASTIAUX, C. GUIBOUT et J.L. PICO (Biomedicine, 1973, sous presse).

L'étude de l'index de fluorescence de membrane de cellules lymphoïdes humaines cultivées en suspension, au moyen d'un sérum anti-lymphocytes marqué par l'isothiocyanate de fluorescéine a montré d'importantes variations d'une lignée à l'autre et pour une même lignée. Ces variations ont été analysées.

L'index de marquage baisse lors de la croissance exponentielle de la culture et remonte lorsque la densité de saturation est atteinte: ces variations ne sont pas en corrélation avec celles du volume cellulaire. Nous avons vérifié la dépendance cyclique

du phénomène en synchronisant une culture par un "double bloc" de thymidine: l'antigénicité diminue en S-G₂-M et augmente en G₁. De plus, l'expression des antigènes de membrane s'accroît depuis la mise en culture des cellules jusqu'à l'établissement d'une lignée.

2,23 Chalones et immunodépression

Inhibition de la réaction du greffon contre l'hôte par incubation in vitro des lymphocytes du donneur, avec les chalones thymique et splénique.

N. KIGER, I. FLORENTIN, E. GARCIA-GIRALT et G. MATHE (Exp. Haematol., 1973, 4, I2)

Inhibition de la réaction du greffon contre l'hôte par préincubation de la greffe avec un extrait thymique (chalone lymphocytaire).

N. KIGER, I. FLORENTIN et G. MATHE (Transplantation, 1973, 16, I8).

Facteur lymphocyto inhibiteur (chalone?), isolé du thymus. Effets immunosuppresseurs dans "Chalone concepts et recherches actuelles".

N. KIGER, I. FLORENTIN et G. MATHE (National Cancer Institute Monograph., 1973, 38, I35).

La chalone thymique s'est révélée capable de déprimer les réactions immunitaires par l'intermédiaire d'une action sur les lymphocytes T seuls (voir tableau I). Son utilisation, en tant qu'agent immunosuppresseur est donc particulièrement indiquée pour le contrôle des réactions immunitaires à médiation cellulaire et singulièrement la réaction du greffon contre l'hôte (GVH). Nous avons précédemment montré que la chalone thymique était efficace dans la prévention de la GVH quel que soit le traitement utilisé: traitement du donneur, traitement du receveur, traitement "in vitro" des cellules du donneur, avant de les injecter au receveur. Ce traitement étant le seul envisageable chez l'Homme, nous avons continué à l'appliquer en choisissant un protocole expérimental qui reproduit, chez la Souris, les conditions de la greffe de moelle chez l'Homme.

TABLEAU 1

ACTION DE LA CHALONE THYMIQUE SUR DIFFERENTES REACTIONS IMMUNITAIRES

Type de lymphocytes cernés.	Réactions immunologiques	:Inhibition de la réaction par la chalone lymphocytaire extraite du thymus
Lymphocytes B :	"In vivo" Formation d'anticorps IGM contre la DNP-flagelline	: -
Lymphocytes :	"In vitro" Formation de rosettes spontanées contre les GRM dans la rate des souris normales	: +
B & T :	"In vivo" Formation d'hémolysines IGM contre les GRM	: +
B & T :	"In vivo" Formation d'anticorps IGG contre la DNP-globuline humaine ++	: +
Lymphocytes T :	"In vitro" Transformation lymphocytaire en présence de PHA	: +
Lymphocytes T :	"In vitro" Transformation lymphocytaire en présence de lymphocytes allogéniques	: +
Lymphocytes T :	"In vivo" Réaction du greffon contre l'hôte	: +
Lymphocytes T :	"In vivo" Réaction de rejet de greffes de peau allogéniques	: +

+ Réponse partiellement indépendante des T lymphocytes
 ++ Réponse hautement dépendante des T lymphocytes

2,3 Facilitation

Inhibition partielle de la réaction du greffon contre l'hôte par injection de sérum facilitant (chez des souris allogéniques)
C. GOUJET, R. MARIAGE et G. MATHE (en préparation)

Le but pratique de toute étude sur la facilitation est d'appliquer les résultats expérimentaux obtenus pour faciliter la prise de greffes d'organes.

Les greffes de moelle osseuse présentent certaines particularités qui les différencient des greffes d'organes. En effet, les lymphocytes se différenciant à partir de cellules souches greffées agressent le receveur. Il faut donc protéger ce dernier contre cette réaction de rejet très particulier, la maladie secondaire, aux manifestations mortelles.

Lors d'expériences antérieures, il a été montré que les immun-sérums obtenus chez la Souris, par injection de cellules lyophilisées et de cellules vivantes, contiennent des anticorps qui ont la propriété de faciliter la prise d'une tumeur. Ces propriétés facilitantes ont été utilisées pour prévenir le développement du syndrome secondaire normalement observé à la suite d'une greffe de moelle osseuse chez un receveur allogénique. Des souris F1 (DBA2 x Balb/c) ont été irradiées létalement, greffées avec des cellulaires médullaires allogéniques C57Bl/6 et traitées par: a) un sérum de souris F1 (DBA/2 x Balb/c) normal, b) un immun-sérum de souris C57Bl/6 anti F1 (DBA/2 x Balb/c). Les animaux témoins greffés et traités par le sérum normal développent tous un syndrome secondaire qui tue 100% des animaux au bout de 60 jours. Chez les animaux traités par le sérum facilitant dirigé contre l'hôte, on observe un retard dans l'apparition des symptômes. Les premières morts surviennent au 70ème jour au lieu de 30ème jour chez les témoins. De plus, 50% des animaux ne développent jamais du syndrome secondaire. L'injection d'un antisérum contenant des anticorps dirigés spécifiquement contre les antigènes d'histocompatibilité d'un receveur permet donc de protéger ce dernier contre le développement de la maladie secondaire induite par une greffe de moelle osseuse allogénique.

Prolongation des allogreffes rénales chez le Chien par association d'immunodépression non spécifique et d'apport d'antigènes de transplantation.
Rôle de l'histocompatibilité et de la facilitation.
D. FRIES, M.C. SIMMLER et B. MARTIN.

L'association d'une immunodépression non spécifique (azathioprine et SAL) et de l'administration d'antigènes de transplantation ($3.5 \cdot 10^9$ cellules médullaires en I.V. à J +8) a permis d'obtenir, au cours de 49 greffes réalisées en dehors de toute détermination de l'histocompatibilité, une prolongation significative de transplant statistiquement supérieure ($P < 0.01$) à celle obtenue par le seul traitement Azathioprine + SAL, cette dernière association ne donnant qu'une prolongation faiblement significative ($p < 0.05$) par rapport au lot témoin.

Dans un travail ultérieur, l'histocompatibilité entre receveur et donneur a été déterminée par différentes techniques, cultures mixtes de lymphocytes unidirectionnelles, groupes D.IA, système antigénique digestif. 14 transplantations rénales ont été réalisées dans différentes combinaisons; les résultats préliminaires confirment l'efficacité de l'administration de cellules médullaires à J +8 et J +15 chez les animaux "compatibles", la prolongation de survie paraissant non significative chez les sujets incompatibles, la validité des tests d'histocompatibilité utilisés doivent être analysés sur un plus grand nombre de sujets.

Dans ce même système expérimental, la mise en évidence d'anticorps facilitants a été tentée avec deux techniques différentes: cytotoxicité des lymphocytes immuns soit vis à vis de cultures de fibroblastes d'origine cutanée, soit vis à vis des lymphocytes du donneur. La première technique n'a donné aucun résultat reproductible; les résultats obtenus avec la "CML" paraissent peu significatifs.

Le développement des tests d'histocompatibilité chez le Chien doit permettre, si les premiers résultats se confirment, d'envisager une extension du modèle de transplantation choisi, la vérification des différents protocoles déjà étudiés chez la Souris ou le Rat, préalable indispensable à l'application en transplantation rénale humaine.

2,4 Conditionnement du receveur

Antigènes de transplantation normaux (H-2)

Les antigènes H-2 solubles; leur effet sur la réaction du greffon contre l'hôte et leur effet sur la réaction de l'hôte contre le greffon.

O. HALLE-PANNENKO, M.C. MARTYRE et G. MATHE (Transplant. Proced., 1972, 4, 517).

Prolongation de survie de greffons de peau allogénique induit par utilisation des extraits d'antigènes H-2 obtenus par différentes méthodes de préparation.

L. BRENT, M. PINTO et O. HALLE-PANNENKO (en préparation)

Au cours de précédents travaux, O. HALLE-PANNENKO, M.C. MARTYRE et G. MATHE ont observé que la réponse immune du receveur contre un greffon de peau allogénique peut être modifiée par le traitement de ces receveurs avec les extraits antigéniques provenant du foie de donneurs. En effet, selon le mode de conditionnement des receveurs, il est possible d'obtenir soit une survie prolongée, soit un rejet accéléré, d'un greffon de peau allogénique. Parmi les nombreux facteurs qui interviennent dans la modification de la réponse de l'hôte contre le greffon, la méthode employée pour l'extraction de ces antigènes ainsi que le stade de purification auquel ils se trouvent, ont paru jouer des rôles importants. Par suite, en collaboration avec L. BRENT, St Mary's Hospital Medical School, Londres, il a été possible d'étudier l'effet "in vivo" de 5 différentes préparations antigéniques insolubles et solubles et de comparer leur capacité de prolonger la survie d'un greffon de peau allogénique. Dans ce système expérimental (Brent 1970), les fortes doses d'extraits antigéniques ont été associées à un agent immunosuppresseur, le sérum anti-lymphocytaire (SAL); l'efficacité des extraits insolubles a été supérieure à celle des extraits solubles. Le mécanisme immunologique impliqué dans ces prolongations de survie est actuellement étudié par l'équipe de L. BRENT, mais il pourrait être différent de celui qui a permis, antérieurement dans notre laboratoire, de prolonger les survies des greffons de peau par utilisation de faibles doses d'antigènes et sans associations aux agents immunosuppresseurs. En effet, dans ce dernier cas, l'efficacité des extraits solubles a été supérieure à celle des extraits lipoprotéiniques, insolubles (rapport 1972). Le mécanisme immunologique impliqué dans les prolongations induites par ce deuxième type de traitement est actuellement étudié par O. HALLE-PANNENKO, M.C. MARTYRE et N. ABUAF: le transfert passif de sérums provenant d'animaux traités par de faibles doses d'antigènes solubles a entraîné une prolongation de survie de greffe de peau. La présence d'anticorps hémagglutinants ou cytotoxiques n'a pu être, cependant, mise en évidence, dans ces mêmes sérums.

Il n'est donc pas déraisonnable de penser que les prolongations observées ne sont pas dues aux anticorps facilitants mais plutôt à la présence d'antigène soluble, soit sous forme libre, soit sous forme du complexe antigène-anticorps.

2,5 Greffe de moelle osseuse

Essais, chez la Souris, de prévention de la maladie secondaire induite par la greffe de moelle; étude dans un modèle préclinique, de différents agents utilisés à cet effet.

G. MATHE, O. HALLE-PANNENKO, N. KIGER, C. GOUJET, A. KUROIWA et C. BOURUT (en préparation)

Greffe de moelle osseuse avec chimérisme lymphocytaire dissocié.

Emploi d'une chalone lymphocytaire et de l'antigène d'histocompatibilité H-2.

G. MATHE, N. KIGER, I. FLORENTIN, E. GARCIA-GIRALT, M.C. MARTYRE et O. HALLE-PANNENKO (Transplant. Proced., 1973, 5, 933).

La greffe de moelle aujourd'hui dans les traitements des aplasies et des leucémies.

G. MATHE, L. SCHWARZENBERG, N. KIGER, E. GARCIA-GIRALT, I. FLORENTIN et O. HALLE-PANNENKO (Clinical Immunology, R.A. Good et F.M. Bach eds., 1 vol., 1973, Academic Press, New-York).

Effet de différents agents sur la prévention de la maladie secondaire, étudiée chez la Souris dans un modèle préclinique.

O. HALLE-PANNENKO, N. KIGER, C. BOURUT, I. FLORENTIN, C. GOUJET, A. KUROIWA et G. MATHE (Exper. Hemat. en préparation).

On a étudié, chez la Souris, l'effet de différents agents dans les essais de prévention de la maladie secondaire. Afin d'approcher au mieux les conditions de la greffe de moelle chez l'Homme, au cours de laquelle les cellules de moelle sont toujours contaminées par le sang, les receveurs F1 (C57Bl/6 x DBA/2) irradiés létalement, ont été restaurés avec 10^7 cellules de moelle provenant de donneurs parentaux C57Bl/6 et 0,1ml de sang complet. Le modèle expérimental a été choisi de façon à être facilement utilisable lors d'une éventuelle application clinique; on a comparé l'effet des différents agents selon leur administration "in vivo" aux receveurs, après la greffe ou selon leur incubation "in vitro" avec les cellules du greffon avant le transfert de celles-ci.

On a étudié l'effet: du sérum de lapin antithymocyte de souris (ATS), du fragment Fab extrait à partir du même ATS, du sérum anti-sites de reconnaissance (SASR), de la chalone thymique des extraits solubles d'antigènes d'histocompatibilité H-2 et d'un sérum facilitant, non cytotoxique dirigé contre les antigènes d'histocompatibilité des receveurs.

Si les traitements, aussi bien "in vivo" qu'"in vitro" par le ATS, le fragment Fab et le sérum anti-site de reconnaissance n'ont donné que des résultats non significatifs, l'administration du sérum facilitant aux receveurs "in vivo" a permis, par contre, de retarder et de réduire de façon significative, la mortalité due à la maladie secondaire; la chalone thymique et les extraits H-2 solubles ont permis d'obtenir des résultats identiques, et cela aussi bien après le traitement de receveurs "in vivo" qu'après l'incubation des cellules de moelle "in vitro".

Greffe de moelle osseuse (suite)

Les relations d'histocompatibilité donneur-receveur en cas de transplantation de moelle osseuse allogénique ont été étudiées chez 13 patients, après conditionnement par une combinaison associant cyclophosphamide et sérum anti-lymphocyte: 10 patients porteurs de leucémie aigue devenus résistants à toute thérapeutique chimique cytostatique, et 3 patients atteints d'aplasie médullaire, déjà soumis antérieurement, sans succès, à une ou deux transplantations de moelle osseuse allogénique, après conditionnement par le seul sérum anti-lymphocytaire. Les résultats sont les suivants: dans cinq cas, la prise de la greffe a pu être observée. Sur 3 patients aplasiques, une prise de greffe a pu être observée mais celle-ci s'est compliquée par une maladie secondaire suraigue; sur 10 patients leucémiques, la greffe a pu être observée; dans 4 cas et chez 2 d'entre eux, elle a été très rapidement compliquée d'une maladie secondaire suraigue.

Tous les donneurs ont été choisis dans la famille proche du receveur, germains ou parents. Le phénotype HL-A a pu être établi chez 12 patients, celui du 13ème n'a pu l'être en raison de l'insuffisance du taux de lymphocytes dans le sang périphérique. La culture mixte de lymphocytes ("MLC") s'est révélée

négative dans les 2 seuls cas où l'identité génétique HL-A a pu être établie.

Si l'on s'attache à l'établissement du seul phénotype HL-A on voit que les résultats ne sont pas significativement différents et qu'il n'y a aucune prise lorsqu'existait une similitude entre donneur et receveur, alors qu'on note une prise sur deux lorsque le phénotype est différent.

Si l'on s'attache à l'établissement, non plus du phénotype mais de l'haplotype, il ne semble pas non plus y avoir de résultats significativement différents: on note presque autant de prises et on observe autant de fois de maladies secondaires que la différence porte sur 1 ou 2 haplotypes.

L'importance relative des deux loci (LA et FOUR) déjà signalée au décours des transplantations de rein, ne semble pas nous apporter de renseignements supplémentaires, encore que les seuls cas de maladie secondaire aient été observés lorsqu'existaient les différences au niveau des deux loci.

Nous avons recherché si la simple existence d'antigènes supplémentaires quels qu'ils soient pouvait jouer un rôle, comme cela avait paru être le cas lors de l'étude que nous avons menée chez des patients conditionnés par le seul sérum anti-lymphocyte. On notait, chez des receveurs greffés qui n'avaient pas présenté de maladie secondaire, la présence d'antigènes chez le donneur que ne possédait pas le receveur; trois patients ayant souffert d'une maladie secondaire suraigue présentaient un conflit antigénique dans les deux sens donneur-receveur et receveur-donneur.

En d'autres termes, il n'existe aucune garantie absolue lorsqu'on considère la fréquence de la prise de la greffe, et aucune garantie absolue lorsqu'on considère le risque de la maladie secondaire dans l'établissement de la compatibilité dans le système HL-A et par la MLC.

Aussi avons-nous l'intention dans l'année à venir de poursuivre et d'amplifier ces essais; en modifiant le conditionnement du receveur par l'adjonction de nouveaux cytostatiques et même un retour à une irradiation totale, et en utilisant la

chalone anti-lymphocytaire mise au point par notre équipe pour conditionner le transplant lui-même, même en cas d'absence de compatibilité apparemment complète donneur-receveur.

2,6 Réaction du greffon contre l'hôte

Recherche d'une corrélation entre des tests d'histocompatibilité in vitro et des phénomènes traduisant une immunité de transplantation, in vivo, dans le cas particulier de la greffe de cellules lymphoïdes chez un receveur incompatible. Mémoire pour le DEA de Biochimie soutenu en Novembre 1972 par N. ABUAF.

Il existe deux principaux tests qui permettent de mesurer l'intensité d'une GVH: le test de la mortalité cumulative et le test de la splénomégalie. Cependant, le premier test (mortalité) mesure le résultat final de l'agression immunologique par les cellules du donneur, tandis que le second traduit une manifestation secondaire de la GVH, dûe essentiellement à la prolifération des cellules du receveur.

Le problème se pose donc de savoir si la quantification de la sévérité de la GVH, mesurée par l'un ou par l'autre des tests est superposable.

N. ABUAF, G. MATHE et O. HALLE-PANNENKO ont induit la GVH par injection de cellules ganglionnaires C57B1/6 (H-2^b) aux trois différents hybrides F1: DBA/2 x C57B1/6 (H-2^d/H-2^b), (C3H x C57B1/6) (H-2⁴/H-2^b) et (AKR x C57B1/6) (H-2⁴/H-2^b).

La GVH la plus grave est développée chez les hybrides (DBA/2 x C57B1/6), qu'elle soit mesurée par le test de la mortalité ou par celui de la splénomégalie. Les réactions observées chez les deux autres hybrides H-2 identiques sont peu différentes d'un hybride à l'autre et ceci pour les deux tests utilisés. Ces résultats suggèrent l'existence d'une bonne corrélation entre le test de la mortalité et celui de la splénomégalie.

Par ailleurs, des récents travaux ont montré l'existence d'une corrélation entre la MLC et le test de la splénomégalie chez des lignées co-isogéniques. Nous avons recherché si une telle corrélation peut être observée chez les lignées non co-isogéniques DBA/2, C3H et AkR et C57B1/6, et si cette corrélation peut être

étendue au test de la mortalité. Les résultats préliminaires suggèrent l'existence d'une telle corrélation.

2,61 Chalone thymique et prévention de la réaction du greffon contre l'hôte. (en modèle préclinique)

Essais de prévention de la réaction du greffon contre l'hôte: greffe de moelle osseuse après conditionnement par le SAL avec chimérisme dissocié. Utilisation d'une chalone spécifique des lymphocytes T d'antigènes H-2 solubles.

G. MATHE, N. KIGER, I. FLORENTIN, E. GARCIA-GIRALT, M.C. MARTYRE, O. HALLE-PANNENKO et L. SCHWARZENBERG.

Inhibition de la réaction du greffon contre l'hôte par incubation "in vitro" des lymphocytes du donneur avec la chalone thymique ou splénique.

N. KIGER, I. FLORENTIN, E. GARCIA-GIRALT et G. MATHE (Exp. Haematol., 1973, 4, 1).

Inhibition de la réaction du greffon contre l'hôte par préincubation de la greffe avec un extrait thymique (chalone lymphocytaire).

N. KIGER, I. FLORENTIN et G. MATHE (Transplantation, 1973, 16, 18).

Transplantation de moelle osseuse dans le cas d'aplasies et de leucémies.

G. MATHE, L. SCHWARZENBERG, N. KIGER, E. GARCIA-GIRALT, I. FLORENTIN et O. HALLE-PANNENKO (R.A. Good et E.H. Bach, ed., 1 vol., 1973, Academic Press, New-York).

Un modèle "préclinique" reproduisant chez la Souris, les conditions de la greffe de moelle osseuse chez l'Homme a été choisi:

Des souris F1 (DBA/2 x C 57B1/6), irradiées létalement, reçoivent par voie veineuse, 10^7 cellules de moelle osseuse et 10^5 leucocytes du sang périphérique, provenant de souris C57B1/6. Les cellules greffées sont préalablement incubées, durant une heure à 37°C, en présence soit de la chalone thymique, soit d'un extrait témoin de rein de veau, ou sans aucun extrait. Une augmentation significative du temps de survie ($p = 0,03$) est observée dans le groupe des animaux ayant reçu des cellules traitées par la chalone.

Des essais de prévention de développement de la maladie secondaire, consécutif à une greffe de moelle osseuse chez l'Homme, par incubation des cellules greffées avec la chalone thymique, sont actuellement en cours.

Pour les leucémies, notre travail porte avant tout sur l'utilisation après une chimiothérapie de réduction des cellules leucémiques de l'immunothérapie active.

3 Traitement des leucémies. Immunothérapie.

3,1 Immunothérapie adoptive.

La greffe de moelle aujourd'hui, dans les traitements des aplasies et des leucémies.

G. MATHE, L. SCHWARZENBERG, N. KIGER, E. GARCIA-GIRALT, I. FLORENTIN et O. HALLE-PANNENKO (Clinical Immunology, R.A. Good et F.M. Bach, eds, I vol., 1973 Academic Press, New-York).

Greffe de moelle osseuse avec chimérisme lymphocytaire dissocié. Emploi d'une "chalone" lymphocytaire et de l'antigène d'histocompatibilité H-2.

G. MATHE, N. KIGER, I. FLORENTIN, E. GARCIA-GIRALT, M.C. MARTYRE et O. HALLE-PANNENKO (Transplant. Proc., 1973, 5, 933)

G. MATHE a démontré antérieurement, que l'on peut éradiquer la leucémie L 1210 portée par les souris hybrides F1 (C57Bl/6 x DBA/2) lorsque celles-ci sont soumises à un traitement d'immunothérapie adoptive. En effet, si les souris F1, porteuses de la leucémie L 1210 reçoivent les cellules ganglionnaires provenant de souris normales de la lignée parentale C57Bl/6, les lymphocytes T présents dans la greffe sont capables de réagir contre les cellules leucémiques (GVL). Cependant, parallèlement à cette activité GVL les cellules greffées exercent également un effet GVH entraînant la mort des animaux.

G. MATHE et O. HALLE-PANNENKO se sont appliqués à dissocier la GVH de la GVL en essayant de rendre tolérants les donneurs aux antigènes d'histocompatibilité normaux des receveurs, sans les rendre tolérants aux antigènes tumoraux. Dans ce but, ils ont administré aux donneurs les antigènes solubles des receveurs à des doses qui, dans d'autres systèmes expérimentaux, s'étaient montrées capables de réduire les réactions d'immunité de transplantation. Ces essais se sont révélés positifs: l'on a pu, en effet, observer à la fois une guérison de la leucémie L 1210 et un retard significatif de la mortalité due à la GVH.

Encouragés par ces résultats, ils ont, en collaboration avec M.C. MARTYRE, essayé de parfaire cette immunothérapie, en augmentant l'effet antileucémique recherché, en soumettant simultanément les donneurs à un second traitement par des extraits d'antigènes de transplantation associés à la leucémie L 1210. Ces travaux sont actuellement en cours.

3,2 Immunothérapie active

3,21 Etudes expérimentales

Effet du BCG sur la croissance de la tumeur de Lewis et de la leucémie L 1210, en fonction de la dose injectée.

G. MATHE, O. HALLE-PANNENKO et C. BOURUT (en préparation).

En utilisant une tumeur solide, la tumeur de Lewis (LLT) et une leucémie, la leucémie L 1210, G. MATHE, O. HALLE-PANNENKO et C. BOURUT ont, au cours d'essais d'immunothérapie active, contrôlé l'activité présumée stimulante au niveau de la réponse immunitaire, des 5 produits suivants: le lipopolysaccharide dérivé du Enteriditis S (LPS), qui est un mitogène des lymphocytes B, le Leutinant que l'on suppose être un adjuvant des lymphocytes T, le Levamisol qui activerait les macrophages, le BCG Pasteur frais dont le mécanisme d'action est actuellement étudié par notre équipe et enfin, le WSA qui est un extrait soluble Micobactérium Smegmatis.

Des 5 substances injectées par voie I.V., seul le BCG s'est révélé actif dans les 2 modèles tumoraux: il est cependant à noter que dans le cas de la tumeur solide LLT, seule la dose de 1mg a eu pour effet une protection, alors que dans le cas de la leucémie L 1210, toutes les doses testées (10,5, 1, 0,5 et 0,1 mg) ont prolongé la vie des animaux de façon hautement significative.

3,22 Essais cliniques

Attempts at immunotherapy of 100 patients with acute lymphoid leukemia: some factors influencing results. G. MATHE, P. POUILLART, L. SCHWARZENBERG, J.L. AMIEL, M. SCHNEIDER, M. HAYAT, F. DE VASSAL, C. JASMIN, C. ROSENFELD, R. WEINER and H. RAPPAPORT. Nat. Cancer Inst. Monogr., 1972, 35, 361.

L'espérance de guérison des enfants atteints de leucémie aigue lymphoïde.

G. MATHE, J.L. AMIEL, P. POUILLART, L. SCHWARZENBERG,
M. HAYAT, F. DE VASSAL, D. BÉLPOMME, M. LAFLEUR.
Arch. Franç. Pédiatrie, 1974, sous presse.

Les essais d'immunothérapie active de la maladie résiduelle laissée par la radiochimiothérapie ont été poursuivis et comportent aujourd'hui 192 malades. On a observé que certains facteurs déterminent le pronostic, le volume tumoral, la présence à la période initiale de cellules dans les méninges qui peuvent exercer leur effet à la fois sur l'immunothérapie et sur la chimiothérapie qui la précède, enfin le type cytologique qui semble pouvoir jouer sur l'immunothérapie seule: tandis que sont en vie sans avoir présenté de rechute à la cinquième année près de 90% des enfants atteints de forme dite macrolymphoblastique et 50% de ceux porteurs du type dit prolymphocytaire, moins de 10% seulement sont en première rémission et en survie parmi les patients souffrant d'une variété prolymphoblastique. La majorité de ceux-ci qui ont une leucémie macrolymphoblastique ont rechuté mais 50% sont vivants après 5 ans; cela suggère que les cellules dites "macrolymphoblastes" sont insensibles à l'immunothérapie donc qu'elles sont sensibles à la chimiothérapie puisqu'après une rechute elles sont resoumises à ce type de thérapeutique.

Lymphosarcome leucémique.

Leukaemic conversion of non-Hodgkin's malignant lymphomas.

G. MATHE, P. POUILLART, L. SCHWARZENBERG, M. HAYAT,
J.L. AMIEL.
Brit. J. Cancer, 1974, sous presse.

Quatre malades porteurs de lymphosarcome, compliqué de leucémie tardive, donc à une période terminale de leur affection, ont été traités par la même radiochimiothérapie que celle appliquée à la leucémie aigue lymphoïde primitive. Ils sont en rémission complète depuis 4 ans.

3,23 Développement des moyens de l'immunothérapie active spécifique.

3,23I Développement des moyens de l'immunothérapie active non spécifique: pharmacologie des adjuvants systémiques de l'immunité.
G. MATHE et M. HAYAT

3,2311 "Screening" expérimental

Recherche expérimentale des adjuvants systémiques de l'immunité applicables dans l'immunothérapie des cancers.

G. MATHE, M. KAMEL, M. DEZFULIAN, O. HALLE-PANNENKO et C. BOURUT (Cancer Res., 1973, 33, 1987)

BCG dans l'immunothérapie des cancers. II. Résultats obtenus avec les différents BCG dans le cadre de la recherche des adjuvants systémiques de l'immunité applicables dans l'immunothérapie des cancers.

G. MATHE, O. HALLE-PANNENKO et C. BOURUT (J.N.C.I., 1973, sous presse).

G. MATHE a établi une série de tests destinés à la recherche expérimentale des agents susceptibles de se comporter comme adjuvants systémiques de l'immunité et être éventuellement appliqués dans l'immunoprévention et l'immunothérapie des cancers chez l'Homme (rappel de l'année dernière). L'ensemble de ces tests permet de détecter l'effet des substances étudiées sur des réponses immunitaires: a) à médiation humorale et impliquant une coopération entre lymphocytes T et B (tests de Jerne), b) à médiation cellulaire (GVH) et enfin c) intervenant dans le contrôle de la croissance tumorale (leucémie L1210 et deux tumeurs solides LLT et ICIG 1).

Parmi les 10 substances étudiées antérieurement (rapport précédent), le BCG frais de l'Institut Pasteur injecté à la dose de 1mg par la voie I.V. s'est révélé être le plus efficace; utilisé dans ces conditions, il a eu pour effet une immunostimulation quel que soit le test employé.

Dans une seconde étude, l'effet du BCG frais de l'Institut Pasteur a été comparé à celui de 9 autres préparations de BCG, toutes lyophilisées mais provenant de différentes sources. Le BCG frais de l'Institut Pasteur s'est encore révélé, de très loin être le plus efficace.

En utilisant la même série de tests expérimentaux, ce travail a été développé au cours de cette année, dans trois directions:

3,2312 Comparaison de 4 différents lots de BCG frais et congelé de l'Institut Trudeau (Saranac Lake, New-York, USA) au BCG Pasteur, soit frais, soit frais et congelé.

G. MATHE, O. HALLE-PANNENKO (en préparation)

Les résultats partiels obtenus dans les études de l'activité adjuvante de 4 différents lots de BCG frais congelé (Institut Trudeau) suggèrent que leur activité immunostimulante (test de Jerne, GVH) est inférieure ou égale à celle du BCG Pasteur frais et congelé mais qu'elle est toujours inférieure à celle du BCG Pasteur frais.

3,2313 Etude de l'effet de BCG Pasteur frais, en fonction de la dose injectée.

G. MATHE, O. HALLE-PANNENKO (en préparation)

L'effet adjuvant du BCG Pasteur frais a été étudié après l'injection par voie I.V. de 10,5, 1 et 0,1mg de cette substance. Les premiers résultats obtenus permettent de noter que le facteur "dose" joue aussi un rôle important. En effet, le BCG injecté à des doses de 1 et 0,5mg entraîne une immunostimulation (test de Jerne) (GVH), alors que l'injection de 10 mg diminue la réponse immunitaire (test de Jerne).

En ce qui concerne l'effet "dose" du BCG sur la croissance tumorale, seule la dose de 1mg induit une protection contre la tumeur solide LLT; dans le cas de la leucémie L1210, toutes les doses testées se sont révélées être efficaces et ont permis de prolonger la vie des animaux de façon hautement significative.

3,232 Recherche de nouvelles substances susceptibles de se comporter comme adjuvants systémiques de l'immunité.

G. MATHE, O. HALLE-PANNENKO (en préparation)

Dans le cadre de la recherche de nouveaux adjuvants, 4 produits ont été étudiés: la lipopolysaccharide, dérivée du Entere-ditis S (LPS), qui est un mitogène de lymphocytes B, le Lentinane que l'on suppose être un adjuvant des lymphocytes T, le Levamisol qui activerait les macrophages et le WSA qui est un extrait soluble de Mycobacterium Smegmatis et dont le mécanisme d'action est actuellement

étudié par l'équipe de E. LEDERER.

Les résultats obtenus dans ces expériences ont montré que des agents sont réellement, dans certaines conditions, des immunostimulants (Levamisol en I.V. et I.P. - GVH; WSA I.V. - test de Jerne), mais qu'ils peuvent être, dans d'autres conditions, des immunosuppresseurs (WSA en I.V. - GVH; Levamisol I.V., LPS en I.V. et I.P., Lentinan en I.P. - test de Jerne), phénomènes déjà observés avec les adjuvants étudiés antérieurement. L'effet de ces 4 substances a été nul, en ce qui concerne l'immunoprévention de 3 tumeurs (L 1210, LLT, ICIG 1).

3,2321 Facteur soluble induit par les adjuvants d'origine mycobactérienne.

F. PARASKEVAS et I.J. HIU.

Réunion d'Immunologie, Strasbourg, Mai 1973 (abstract)

Une augmentation de la teneur en Ig cytophiliques (Ig-C) a été observée dans le sérum des souris préalablement traitées par l'adjuvant hydrosoluble "MAAF" extrait du BCG (Nature New Biology, 1972, 238, 241). Ces Ig-C sont captés par les cellules T en présence d'un antigène soluble.

L'incubation du sérum avec un agrégat d'antigène abaisse la teneur en Ig-C mais l'éluion de l'agrégat d'antigène permet de retrouver la teneur primitivement élevée en Ig-C.

Le fractionnement du sérum sur Sephadex A-200 montre la présence d'un facteur (F4S) contenu dans la fraction 4 S. L'augmentation d'Ig-C résulte de l'interaction entre le facteur F4S (induit par l'adjuvant), l'Ig 7S et l'antigène soluble. Les Ig-C ainsi formés sont captés par des cellules T dans les suspensions de cellules spléniques normales en provoquant l'augmentation de cellules porteuses d'Ig.

Ces effets peuvent être reproduits en utilisant l'adjuvant complet de Freund.

3,2322 Préparation et caractérisation de nouveaux adjuvants
Etude de la structure, et de l'activité des extraits
immunostimulants de bacilles tuberculeux.

I.J. HIU (à paraître)

Les cires D sont des substances lipidiques à activité immunostimulante, extraites à partir des bacilles tuberculeux de souches humaines. Ce sont des macromolécules constituées par un mucopolysac-

charidique des cires D contient des sucres aminés partiellement N-acétylés. La teneur en sucres aminés N-acétylés (SANA) varie selon les souches. Isolées à partir de la souche humaine Canetti, les cires D de faible teneur en SANA ont une activité immuno-stimulante plus élevée que celles isolées à partir de la souche humaine Peurois à teneur plus élevée en SANA. Les cires D, isolées du BCG, à forte teneur en SANA ne sont pas actives. La paracétylation rend les cires D inactives comme l'adjuvant de l'immunité. Par contre, l'acétylation sélective des groupes hydroxyles des sucres et sucres aminés n'entraîne pas la disparition de l'activité des cires D. La peracétylation touche la partie mucopolysaccharidique et particulièrement les groupes hydroxyle et aminé primaire. L'activité immunostimulante des cires D apparait donc comme liée à la présence d'une certaine teneur en sucres aminés non acétylés.

3,2323 Préparation des dérivés liposolubles.

I.J. HIU (à paraître)

Dans le but d'obtenir des dérivés plus actifs, nous avons pensé à fixer un acide gras sur les OH libres d'un composant à activité immunostimulante que nous avons isolé à partir du BCG: la fraction appelée "MAAF". Nous espérons que la fixation d'un acide gras à longue chaîne confèrera au MAAF une liposolubilité modifiant dans un sens favorable, son activité immunologique.

Le MAAF, après traitement par le chlorure de l'acide laurique, nous fournit l'ester recherché mais qui est mélangé à l'anhydride laurique formé vraisemblablement au moment de l'hydrolyse de l'excès du chlorure de l'acide gras. Nous cherchons actuellement à mettre au point une méthode pour purifier le dérivé cherché.

Par contre, l'acétylation du MAAF à l'aide de l'anhydride acétique, dans la pyridine, nous donne un dérivé liposoluble à l'état purifié.

3,2324 Mécanisme d'action des adjuvants

G. MATHE, N. ABUAF, M. BRULEY, I. FLORENTIN, R. HUCHET, A. KHALIL, O. HALLE-PANNENKO, H. RAPPAPORT (en préparation).

Chaque adjuvant est soumis à une batterie de tests

immunologiques qui permettent de disséquer son action sur les lymphocytes T, les lymphocytes B et les macrophages. Les observations peuvent être effectuées au niveau de la rate, des ganglions, de la moelle osseuse et de l'exudat péritonéal. Les facteurs temps et voie d'administration s'étant révélés très importants au cours du "screening" expérimental des adjuvants, l'étude de l'influence de ces paramètres a été maintenue.

Les résultats rapportés ici concernent l'étude du mode d'action du BCG.

L'administration de 10^6 de BCG, par voie veineuse augmente la capacité des cellules ganglionnaires, d'induire une réaction de GVH chez un hôte incompatible. Le BCG injecté par voie veineuse, ou sous-cutanée, est sans effet sur le développement des réactions d'hypersensibilité retardée. L'action du BCG sur les lymphocytes T impliqués dans des réactions immunitaires à médiation cellulaire semble donc inconstante.

Au niveau de l'immunité à médiation humorale, l'administration de BCG, par voie veineuse, augmente significativement dans la rate, les nombres de cellules formatrices d'anticorps contre les GRM (réponse IgM et IgG) et contre le DNP que cet haptène soit couplé à un antigène thymo-dépendant (hémocyanine, réponse IgG) ou à un antigène thymo-indépendant (flagelline, réponse IgM). La voie sous-cutanée s'est montrée moins efficace que la voie veineuse. Ces résultats révèlent une action du BCG sur les lymphocytes B mais il est nécessaire de déterminer si cet effet résulte d'une action primaire sur les lymphocytes T, soit "Helper" soit suppresseurs.

Sous l'influence du BCG, les macrophages subissent des phénomènes d'activation qui se traduisent par une augmentation du taux des phosphatases acides, révélées cytochimiquement et par le développement d'une activité cytotoxique, non spécifique, vis à vis de cellules tumorales. Cette activité cytotoxique est présente dès le 3ème jour après l'injection de BCG, est affaiblie au 7ème jour et manifeste une recrudescence vers le 14ème jour, puis se maintient durant au moins deux semaines. La voie veineuse est plus efficace pour l'induction de ces phénomènes d'activation que la voie sous-cutanée.

Histologiquement, l'administration intraveineuse de BCG provoque, au cours de la première semaine, une hyperplasie des cellules de la zone corticale, du thymus, le développement des zones

thymo-dépendantes de la rate et des ganglions. A partir de la deuxième semaine, on observe une infiltration histiocytaire dans la rate, le foie et parfois les ganglions lymphatiques; cette infiltration se développe et se maintient durant plusieurs semaines. Ces phénomènes sont moins intenses et apparaissent plus tardivement quand la voie d'introduction du BCG est sous-cutanée. D'un point de vue dynamique, le BCG provoque une séquestration de lymphocytes circulants (cellules ganglionnaires marquées au ^{51}Cr , injectées par voie veineuse, dans la rate et les ganglions inguinaux et axillaires quand l'adjuvant est injecté par voie veineuse et dans les ganglions drainant le site d'une injection sous-cutanée. Ce phénomène, rapide, atteint son intensité maximum 24 heures après l'administration de BCG. On observe, parallèlement, une inhibition de la migration des cellules injectées vers les ganglions mésentériques et vers la moelle osseuse mais avec une cinétique différente selon la voie d'administration du BCG.

Ces résultats, encore très incomplets, révèlent déjà la complexité du mode d'action du BCG mais dont la connaissance permettrait une utilisation encore plus efficace de cet adjuvant dans les essais d'immunothérapie active non spécifique.

TESTS IMMUNOLOGIQUES UTILISES POUR L'ETUDE DU MECANISME D'ACTION DES
ADJUVANTS

Types cellulaires impli:		Tests	Responsables
Types	Sous types		
Lymphocytes:		Transformation lymphocytaire par	I.FLORENTIN
:		la phytohémagglutinine (PHA)	:
T		Hypersensibilité retardée au chlo:	R. HUCHET
:		rure de pycril, l'oxazolone.	:
:		Réaction du greffon contre l'hôte:	O.H.PANNENKO
:	T "tueurs":	(GVH)	:
:		Lymphocytotoxicité	N. ABUAF
Lymphocytes:		Transformation lymphocytaire par	I.FLORENTIN
T et B		le pokeweed (PWM)	:
:		Formation d'anticorps contre les	O.H.PANNENKO
:		globules rouges de mouton (GRM)	:
:	Lymphocytes:	Formation d'anticorps contre l'hé:	R. HUCHET
:	T	mocyanine - DNA	:
Lymphocytes:		Transformation lymphocytaire par	I. FLORENTIN
B		le lipopolysaccharide (LPS)	:
:		Formation d'anticorps contre la	R. HUCHET
:		flagelline - DNP	:
Macrophages:		Cytotoxicité des macrophages	I. FLORENTIN
:		:	M. BRULEY
Divers		Histologie - cytochimie	H.RAPPAPORT
:		Séquestration des lymphocytes cir:	A. KHALIL
:		culants.	I. FLORENTIN

Tissus testés: rate, ganglions, moelle osseuse, exudat péritonéal.

3,233 Immunsation par les antigènes tumoraux (leucémiques)

Isolement des antigènes associés aux leucémies murines.
Etude de leur activité "in vivo".
M.CL MARTYRE (en préparation)

Utilisant une leucémie induite par le virus de Rauscher transplantée sous forme ascitique greffable, la leucémie RC₁₉ on a poursuivi l'étude comparative de l'activité "in vivo" d'antigènes de surface obtenus par chocs hypotoniques ou par chocs hypertoniques; deux types d'essais ont été réalisés: des essais de protection contre une greffe de cellules RC₁₉ (immunoprévention) et des essais d'éradication de cette greffe (immunothérapie). Dans les essais d'immunoprévention précédemment réalisés, le prétraitement de souris isogéniques par les extraits solubles avait conduit à des résultats diamétralement opposés selon la méthode de préparation de l'extrait: les extraits préparés par chocs hypotoniques (HSA) avaient eu pour effet une facilitation d'une greffe de cellules RC₁₉ alors que les extraits obtenus en milieu hypertonique (KSA) s'étaient révélés capables de protéger les animaux contre la greffe de cellules tumorales.

Dans les essais d'immunothérapie, réalisés cette année, les deux extraits (HSA et KSA) se sont montrés capables de protéger des souris isogéniques contre une greffe de cellules RC₁₉ qu'il s'agisse d'une greffe sous-cutanée ou intrapéritonéale; ces résultats ont été obtenus lorsque la première injection d'antigène a été faite au jour 0, jour de la greffe de cellules tumorales. On a tenté de mettre en évidence une éventuelle corrélation entre l'effet observé "in vivo" et l'immunité à médiation cellulaire, induite chez les animaux traités; le test de lymphotoxicité utilisé à cette fin n'n'a donné, dans les premiers essais, que des résultats négatifs; ces essais demandent à être renouvelés et corrélés par d'autres tests.

3,3 Immunothérapie passive

Préparation chez un hôte hétérologue d'anticorps spécifiques des leucémies murines induites par les virus de Gross et de Graffi.
C. FERREIRA DE SANTANA, J.F. DORE, C. DIATLOFF,
C. GUIBOUT, A. COUDERT et R. MOTTA (en préparation)
L'analyse des 4 causes d'échecs et des limitations

des essais antérieurs d'immunothérapie passive (R. MOTTA, Adv. Cancer Res., 1971, 14, 161) permet d'envisager de reprendre ces études en cherchant plus particulièrement: a) à obtenir chez un hôte hétérologue des antisérums spécifiques des antigènes tumoraux (modèle éventuellement applicable aux tumeurs humaines) et, b) à augmenter l'efficacité "in vivo" des anticorps injectés. Un travail préliminaire a donc consisté à obtenir chez le Lapin et à purifier des antisérums spécifiques des antigènes de surface de leucémies de Gross et de Graffi de la souris C57Bl/6.

Des lapins ont été immunisés par des cellules Eo G2 (G+) ou GiL 4 (FMR Gi+) recouvertes d'un excès de sérum de lapin anti cellules spléniques C57Bl/6 normales, selon la technique décrite par R. WEINER. Les antisérums obtenus dans ces conditions ont néanmoins révélé une forte activité contre des cellules normales C57Bl/6. Cette activité n'a pu être modifiée par une absorption "in vitro"; seule une absorption "in vivo" sur des souris C57Bl/6 a pu conduire à une spécificité de l'antisérum pour les cellules leucémiques. Après absorption les antisérums conservant une forte activité sur des cellules leucémiques (titre de l'ordre de 1/3000, test de cytotoxicité), et sont spécifiques des cellules leucémiques utilisées pour l'immunisation (absence de réactivité d'un sérum anti GiL 4 sur des cellules Eo G2).

Ainsi a pu être confirmée la possibilité d'obtenir chez un hôte hétérologue des antisérums spécifiques des antigènes tumoraux et de haute activité.

Istituto di Ricerche Farmacologiche 'Mario Negri'

Contract Number : O88-72-1- BIA C

Head : Silvio Garattini, M.D.

CONSEQUENCES OF RADIATION EXPOSURE, PREVENTION AND
TREATMENT OF PATHOLOGICAL EFFECTS

RESULTS OF PROJECT

This multiyear project is mainly devoted to gain a better knowledge of the activity and body handling of radiomimetic - immunodepressants which may form the basis both for a better therapeutical use of these agents and an understanding of their multifaceted interaction with the organism. In this frame after the results presented in the past about interactions between cytotoxics and noncytotoxics agents, a continuation of the work on drug interactions among cytotoxics has been carried out with the identification of a number of antagonisms between widely employed agents revealed both by studies of in vivo activities and of pharmacokinetic parameters of the drugs. As regards the mechanisms, interactions both at the single cell level and operating at the level of the organism's metabolic activity were recognized.

In the course of these studies, which require the availability of drug-measuring methods of ever-increasing sensitivity, a novel technique for the dosage of cyclophosphamide has been produced. Along a different line of work aimed at investigating the effects of radiomimetics on cell antigenicity, a further progressions in elucidating the phenomenon of antigenic modification of tumor cells by cytotoxic have been obtained regarding the kinetics of the antigenicity modification, its immunological

basis, the specificity of the antigenic change and the possibility of its induction in a variety of cells with a series of agents . Investigations on the induction of this phenomenon in normal cells are underway . Related to this type of work , the characterization of the immunosuppressive and hematotoxic properties of dimethyltriazenoimidazol carboxamide has been completed ; this agent has shown quite remarkable characteristics and may therefore represent an interesting drug for use in immunosuppression.

Results of project No.1

Investigators : F.Spreafico , M.D., A. Vecchi,
dr.Biol.Sci. , A.Mantovani, M.D. and
E.Bonmassar ,M.D.

Title of project : THE ACTIVITY OF DIMETHYLTRIAZENO
IMIDAZOLE CARBOXAMIDE ON IMMUNOLOGICAL
RESPONSIVENESS AND HEMATOPOIETIC STEM CELLS
IN MICE

This work which was initiated in 1972 and has already been partially described, has been now completed and being processed for publication . The interest in this study consisted not only in the desire to more fully characterize this agent (DIC, NSC 45388) which is increasingly employed clinically , but also in the attempt to obtain more information on the important phenomenon of antigenic modification of cells induced by DIC and other cytotoxics (cfr.project No. 2) . From this study , in which comparisons for all in vivo activities have been conducted with cyclophosphamide , DIC has been found to be a very potent immunosuppressant with some interesting characteristics . The agent is capable of interfering both with circulating antibody production assayed by the localized hemolysis in gel system as well as cell-mediated responses as judged by a tumor allograft rejection assay . In its immunosuppressive activity , DIC was as potent as cyclophosphamide but its effect were much more long-lasting, in addition its interference with secondary responses requires dose only moderately higher than those necessary for depression of primary antibody production. These characteristics would thus seem to indicate that this compound may represent an useful adjunct to the list of immunodepressant currently available . As regards the activity of DIC on hematopoietic stem cells revealed by

the classic spleen colony assay , the results obtained show that this agent is capable of inhibiting this cell population, however the bone marrow appears to be relatively spared in comparison to the immune system since drug doses capable of almost completely abolishing immune responses only moderately affect the stem cell numbers ; moreover the recovery to a normal marrow function is substantially more rapid than the return to normal of the immune capability.

Results of project No. 2

Investigators : F.Spreafico, M.D. ; A.Mantovani, M.D. ;
A.Vecchi, dr.Biol.Sci. ; A.Nicolin, M.D.

Title of project : ANTIGENICITY-MODIFICATIONS INDUCED
IN TUMOR CELLS BY TREATMENT WITH CYTOTOXIC AGENTS

It was previously shown that if leukemia cells had been exposed in vivo to treatments with cytotoxic agents , such for instance DIC, a modification in their properties occurred as revealed by the fact that when the "treated" cells were transplanted into normal isogenic recipients, prolonged or indefinite survivals were seen whereas even a single "normal" cell of the same tumor is capable of producing a lethal take . That this result is the consequence of a drug-induced modified immunogenicity so that a strong immune response is elicited ultimately leading to rejection of the neoplasm , was firstly indicated by the observation that when the isogenic host had been immunosuppressed before injection of modified cells , the hosts succumbed to the tumor in the same time as controls given normal cells . In the effort to gain further information on this phenomenon and on this biologic activity of cytotoxics, we have been able to prove its immunological basis by showing that lymphocytes obtained from animals given the modified cells are cytotoxic in vitro against these elements and are able to protect , in passive transfer experiments unresponsive hosts against a challenge with the tumor . This phenomenon has now been shown to be inducible in a number of leukemia-lymphoma systems using quite a range of cytotoxic radiomimetic agents . The development of resistance by the cells towards the agent employed appears not to be a necessary prerequisite for the induction of antigenic modification,

which once induced is a stable and inheritable characteristics, since even inactive compounds can alter the cell ,nor do immunoselection processes seem to play a major role in the phenomenon .

In a study of the kinetics of induction of antigenic modification, the minimal requirements in terms of drug treatment and target cell population size required have been investigated, showing that even a single injection of cytotoxic agent can be followed by an increased immunogenicity of the tumor cells .

Preliminary results indicate that a specific antigen(s) is induced by an agent on every tumor but that cross-reactivity between the modified and normal cells of a given tumor line can also exist . Lastly, very marked synergism between chemotherapy and increased tumor immunogenicity has been demonstrated in these systems , a result which may be of interest in the clinical exploitation of this type of results.

Results of project No. 3

Investigators : F.Spreafico, M.D. ; A.Vecchi, dr.Biol.
Sci. ; M.G.Donelli, dr.Biol.Sci. and A.Bossi,
dr.Biol.Sci.

Title of project : DRUG INTERACTIONS IN IMMUNO-
SUPPRESSIVE TREATMENT

This type of investigations is considered especially relevant in a time where, in the effort to achieve always more effective and safe control of immune responses , the use of combinations of agents is increasingly employed. The continuation of the studies, already partially described in the 1972 report from this Institute , has delved firstly with a more complete characterization of the L-asparaginase-methotrexate interaction, a couple of compounds which potentially appeared to hold some promise for immunosuppressive treatments in view of their characteristics (for instance , the activity of L-asnase on B lymphocytes , the possibility to reduce the toxicity of MTX by folinic acid, etc.) . From this study, this type of combination treatment does not seem to be easily manageable, in fact antagonism, of various degrees depending on the experimental conditions, of MTX activity is induced by a prior injections of the enzyme ; such antagonism appears to be schedule-dependent in the sense that it is no longer seen if the L-asnase is given 12 hrs or more before MTX , nor when MTX precedes the enzyme. In an effort also to shed some light on the mechanism(s) of these observations, a series of investigations with other drug combinations have been performed ; and a second example of antagonism by L-asnase on cytarabine activity has been revealed, and another in the prednisone-cyclophosphamide combination ; the characteristics of the latter have not yet been completely detailed; it appears that cyclophosphamide

activity can be either reduced or increased depending on the relative order of injections of the two compounds . Always in the same hope of acquiring greater information on the safety of combined treatments (in this context also a reduction of activity can be interpreted as an expression of "toxicity" at large), a series of investigations have been carried out on the possible effects of previous treatments with radiomimetic cytotoxics on the metabolism and disposition of other cytotoxics subsequently administered.

Mice were therefore treated with cyclophosphamide and the blood levels of other agents (MTX , 6-mercaptopurine , daunomycin, 5-fluorouracil) administered orally 7 days later, were followed . The data so far obtained have revealed that the MTX plasma concentrations are higher in the pre-treated animals ; on the other hand , 6-MP and daunomycin levels are reduced in animals given cyclo-P 7 days earlier. An increased absorption was observed also for 5-Fu , giving altered profiles of drug levels in plasma.

Results of project No. 4

Investigators : M.G.Donelli, dr.Biol.Sci . ; A.Bossi ,
dr.Biol.Sci. and A.Martini , dr.Biol.Sci.
and F.Spreafico, M.D.

Titlre of project : DISTRIBUTION AND METABOLISM OF
IMMUNOSUPPRESSIVE AGENTS

As repeatedly discussed before, it is our belief that for a more "on target" use of radiomimetics immunosuppressants , greater knowledge of the pharmacokinetic parameters of the agents employed should prove useful, as well as of the factors that may influence these aspects.

Among the latters, a study in mice has revealed differences in the rates of metabolism of cyclophosphamide, and consequently in the in vivo activity , depending on the genetical constitution of the host . The age of animal is another factor of importance: studies with 6-MP in rats of various ages, have shown that at relatively minor ages , the levels of the drug are substantially higher and the half-life longer than in older animals . Circadian rythmicity in the body handling of 6-MP was also found, in the sense that afternoon administrations of the drug result in higher peak levels than obtained with a.m.injections.

The influence of the route of administration on the serum concentrations of 6-MP has also been investigated as part of a series of investigations aimed at obtaining as complete as possible a picture on the pharmacology of this agent.

As expected the serum concentrations of this compound are higher after i.v. than after i.p. administrations ; however 6 hours after injection , the drug is detectable in the serum only after i.p. injection.

The importance of the adipose tissue as a compartment into which immunosuppressants can be stored, has also been given attention ; for 6-MP and MTX it was found that they are present

in only low amounts in the adipose tissue whereas methyl-nitrosourea as well as adriamycin accumulate heavily and for prolonged periods even after single injection at times when no drug is longer present in the serum.

It is obvious that for carrying out this type of studies , the availability of always more sensitive and specific analytical methods is critical . In this spirit , efforts have been devoted to the establishment of a novel sensitive technique for the detection and measurement of cyclophosphamide . This gas-chromatographic technique is based upon the transport of cyclophosphamide into its N-trifluoroacetyl derivative . The minimum detectable amount is 25 pg/injection which corresponds to a sensitivity of 25 ng/ml of plasma. These results are in the process of publication .

Vertragspartner der Kommission :

Land Baden-Württemberg, vertreten durch die Universität Ulm

Nr. des Vertrages : 088-72-1 BIAC

Leiter der Forschungsgruppe : Prof. Dr. Theodor M. Fliedner

Allgemeines Thema des Vertrages :

Effects of ionizing radiation on mammalian organisms
and their treatment

Allgemeine Darstellung der durchgeführten Arbeiten :

The work of the research group in Ulm continued in 1973 along the lines proposed in the original research plan. The activities are concerned with 3 major areas. In the first area, the biological effects of tritium incorporated into various cell constituents of rats in relation to its biochemical form (tritiated water, tritiated thymidine) are studied in comparison to external X-irradiation. For these studies the model of prenatal complete radioactive labeling is being used which produces a particular type of continuous whole body irradiation. These animal studies are meant to contribute eventually to recommendations with respect to the permissible body burden of various tritiated compounds, a problem that is of significance in people involved in maintenance operations of nuclear reactors. The second research area concerns itself with the improvement of methods to combat radiation injury as seen after radiation accidents leading to whole body radiation exposure. On the one hand, infection as a consequence of radiation induced granulocytopenia needs to be considered : the Ulm group continued its participation in the EORTC Gnotobiotic Project Group which conducts a randomized trial in Europe to investigate the efficiency of gnotobiotic treatment of infection in bone marrow failure by means of antibiotic decontamination and maintenance of the "gnotobiotic patient" in a germfree environment. Several new patients could be added to the study. On the other hand is the pre-clinical study in dogs to collect from the peripheral blood cells capable of restoring hemopoiesis in lethally irradiated recipients after having been stored at ultra-low temperatures. Basic studies to characterize these blood stem

cells in the autologous system are combined with studies in the allogeneic system. Several long term (more than 100 days) survivors with functioning grafts were obtained and will also be used for late effect studies of various organ systems. Since the combat of graft-versus-host disease is and will continue to be a problem in the allogeneic situation, the basic study in mice has been continued in which it was shown that bacterial decontamination of bone marrow transfused irradiated mice with a normal microbial flora leads to a drastic reduction in the incidence and severity of graft-versus-host disease. These studies were repeated and even better results obtained. The third area of research in 1973 is concerned with basic studies on the physiology and radiopathophysiology of the hemopoietic stem cell pool. A more thorough understanding of the mechanisms of bone marrow regeneration after whole body irradiation with or without marrow transfusion depends on the understanding of the structure and regulation of the stem cell pools. Thus the 1973 studies are related to the development and function of the embryonic stem cell pool in rats and the interrelation of the various "committed" stem cell pools and the "uncommitted" pool of stem cells. Here, a new model was established using the hypertransfused, germfree mouse as a test system in which erythropoiesis and granulocytopenia can be manipulated in very interesting ways. Due to the decreasing purchase power of the money for this contract, projects 1 and 2 as well as 4 and 5 had to be combined. One project was carried out as a sub-contract with Prof. Lucarelli in Pesaro.

Ergebnisse des Projektes Nr. 1

Leiter des Projektes und wissenschaftliche Mitarbeiter :

T.M. Fliedner, W. Calvo and W. Schreml with R.J. Haas,
E.B. Harriss and M. Spoljar

Titel des Projektes :

Early and late tritium toxicity in rats.

Results :

In this study, 2 approaches were used in 1973. The first approach uses the new born rat which has been exposed to tritiated compounds by means of a continuous infusion to the mother during the embryonic development. The second approach uses the adult rat, to which tritiated thymidine is given by continuous infusion. As an endpoint, the testis was chosen to study radiation toxicity.

The studies on dosimetry of tritiated compounds in the new born rats continuously exposed to $^3\text{H-TdR}$ or HTO during pregnancy have been extended to include, in addition to the reduction of oocyte number, the parameters of general development of hemopoietic competence and chromosomal aberrations. A factor of internal RBE between $^3\text{H-TdR}$ and HTO in the order of 2.5 to 5.5 has been estimated for the induction of impaired development and damage to the hemopoietic system, and a factor around 5.4 for the effect on oocytes.

A comparison with fractionated X-ray irradiation in 1 or 2 sessions per day from day 9 of pregnancy to term in the range of 5 to 30 rad/day showed a depletion of oocyte number of approximately 50 % when 5 rad/day were given. The comparison with the dose absorbed by the ovarian nuclei from incorporated tritium showed comparable results after HTO exposure, while the value for $^3\text{H-TdR}$ animals was markedly lower. A comparison of the absorbed dose in liver cell nuclei necessary to induce a defined amount of chromosomal breaks after $^3\text{H-TdR}$ exposure with data reported on external irradiation indicated an unusual high biological effectiveness for $^3\text{H-TdR}$.

These findings lead to an investigation of the time parameters of tritium accumulation in the mother - fetus system during infusion of ^3H -TdR and HTO. Circulating activity is virtually completely present in volatile form both during HTO and ^3H -TdR infusion, and increases during the first part of infusion until it levels off after day 11. After ^3H -TdR, tritiated water, the principal metabolite of non-DNA-incorporated ^3H -TdR, follows a similar distribution pattern as observed during the infusion of HTO. Equilibrium of the volatile activity between the blood of the mother, the amniotic fluid and the blood of the babies was established at the time of Cesarean section.

Studies were performed on the distribution of Methyl- ^3H -TdR, TdR-6- ^3H and TdR-2- ^{14}C in new born rats in a time schedule varying both the time of application and of elimination between 1 and 7 days. These studies indicate the establishment of a characteristic distribution pattern between subcellular fractions for the radioactivity of each isotope which is established within one day and is not influenced by the various time parameters. This is taken to indicate that the circulating volatile activity represents one factor of a constant distribution pattern. Under these assumptions, it is possible to calculate cumulated doses for the time of infusion and to correlate these data with the time of maximum radiosensitivity.

The studies in adult rats used the testis for the investigation of the radiotoxicity of tritiated thymidine to the gonads. Five male Wistar rats weighing ca. 200 g were submitted to a selective internal irradiation of the nuclei of cells in DNA synthesis by a continuous intravenous infusion of ^3H -TdR (specific activity = 6 Ci/mM), using a Harvard pump. Each animal received 864 $\mu\text{Ci/day}$ during 18 days. At the end of the experiment the total activity found in the homogenized tissues of the animals after exanguination was between 9.013 and 16.532 $\mu\text{Ci/g}$ with an average of 12.813.

Sections of testes fixed in formalin and imbedded in paraffin were submitted to the Periodic acid-Schiff reaction for the de-

monstration of carbohydrates and stained with hematoxylin for morphological studies. The seminiferous tubules of the organ appeared to be almost totally depleted of spermatogonia. In Fig. 1 the effect of the continuous infusion of the ^3H -TdR in testes can be seen in comparison with the organ of a normal animal of the same age.

The disappearance of the germinal layer of the seminiferous tubules, represented by the spermatogonia, leads to aplasia of the organ and to sterility.

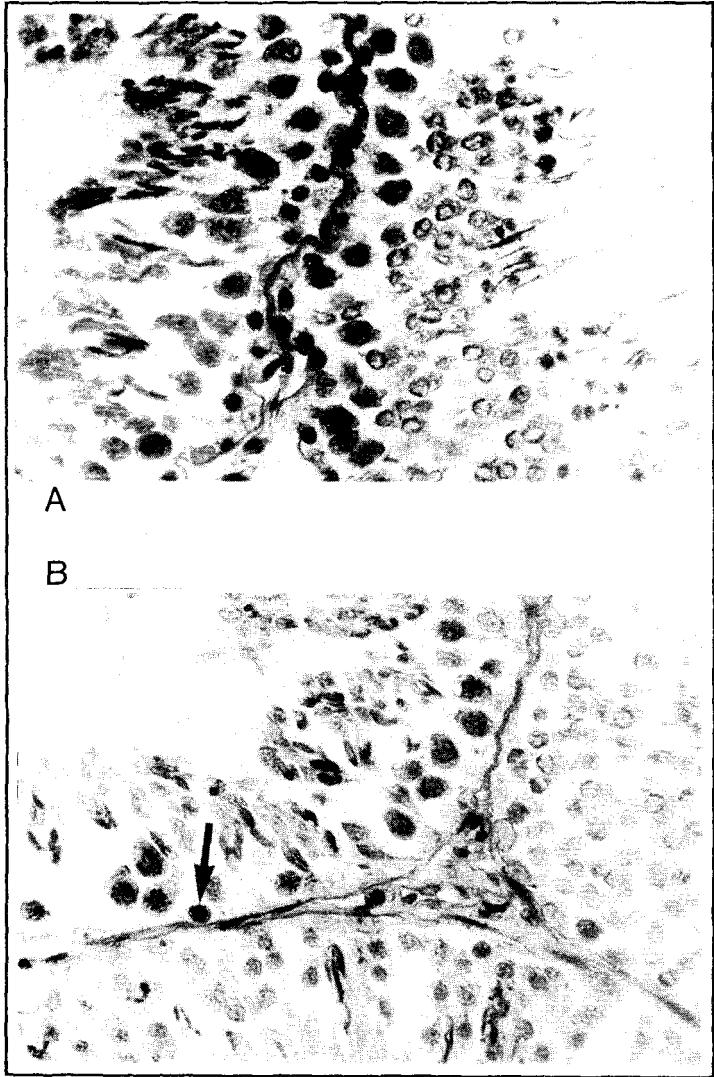

Fig. 1 : Section of testicle of 4 month old Wistar rat

- a. Seminiferous tubules of a normal animal, showing numerous spermatogonia. X 540.
- b. The seminiferous tubules of a rat receiving 864 μ Ci per day, during 18 days, show only one spermatogonia in approximately the same area (arrow). X 540.

Ergebnisse des Projektes Nr. 2

Leiter des Projektes und wissenschaftliche Mitarbeiter :

T.M. Fliedner, with C. Bruch, W. Calvo, H.D. Flad, S.F. Goldmann, E.B. Harriss, E. Herbst, E. Hügl, R.P. Huget, K. von Loringhoven, W. Nothdurft, W.M. Ross und H.P. Schnappauf.

Titel des Projektes :

Blood stem cell transfusion into lethally irradiated dogs as a preclinical model for the treatment of radiation induced hemopoietic failure.

Results :

The aim of this program is to achieve engraftment of allogeneic stem cells of the peripheral blood under defined histocompatibility conditions as compared to autologous transfusion results. Since a severe graft-versus-host reaction in lethally irradiated recipient dogs is to be expected after allogeneic transfusion, the number of cells transfused should be high enough to induce regularly a haemopoietic regeneration and low enough to limit the subsequent "secondary disease". Furthermore, the histocompatibility conditions in our beagle colony have to be defined so that the degree of "secondary disease" in donor-recipient sibling combinations can be calculated. On this basis, further steps towards the mitigation of "secondary disease" could be undertaken, i.e. by cell separation procedures to purify stem cells or by immune manipulation in vitro and in vivo.

The results in this program obtained during 1973 may be summarized as follows :

1. Stem cell transfusion : Blood leukocytes were collected from beagle dogs by an IBM cell separator, frozen and stored at -196°C . They were thawed, and various numbers of mononuclear cells were transfused into lethally irradiated (1200 rad) recipient littermate dogs. Regeneration in the bone marrow

and peripheral blood was followed. 2/3 dogs transfused with $7 - 8 \times 10^9$ DL-A identical mononuclear cells showed signs of regeneration of the bone marrow 7 - 14 days after irradiation. 5/5 dogs receiving $13 - 17 \times 10^9$ DL-A identical mononuclear cells showed marrow regeneration within 6 - 10 days after irradiation. 2 dogs received $22 - 26 \times 10^9$ mononuclear cells from a DL-A identical MLC negative sibling. One died with generalized fungal infections on day 19 after transfusion, the second dog is a complete chimera 7 months after transplantation.

In parallel, 2 dogs are under study beyond 80 days after 1200 rad whole body x-irradiation and transfusion of autologous blood leukocytes that had been stored at ultra-low temperatures. They are also in good clinical condition and will be now the subject of studies to characterize the pathogenesis of late effects to be expected in various organ systems, including bone marrow after 1200 rad. To demonstrate the regeneration of the hemopoietic stem cell pool, the agar-colony system and the millipore-chamber system are being employed to demonstrate cells with various hemopoietic potentialities.

2. Histocompatibility testing : Anti DL-A antibodies were raised by skin grafting. At present the following DL-A specificities can be detected by our own sera : DL-A (1 + 13), 2, 3, 4, 5, 6, 7, 9, 13 and Ulm 55, a non DL-A antigen.
3. Mixed lymphocyte cultures : A semi-micro-method has been developed and applied to family testing in our dog colony. It was possible to identify 4 lymphocyte-defined (LD) determinants on dog lymphocytes using DL-A homozygous stimulator cells and heterozygous responder cells. Two further LD specificities are at present under study.
4. Cell mediated lympholysis : This technique has been developed for dog lymphocytes and it could be shown that LD differences and DL-A (=SD) differences are required in this system.

Ergebnisse des Projektes Nr. 3

Leiter des Projektes und wissenschaftliche Mitarbeiter :

T.M. Fliedner, M. Dietrich (clinical), H. Heit (experimental)
with W. Heit, G. Hochapfel, D. Krieger, H. Meyer, H. Rasche und
E. Vanek

Titel des Projektes :

Bacterial decontamination as a means to combat bacterial infection and graft-versus-host disease in patients and experimental animals with bone marrow failure and after bone marrow transfusion.

Results :

The experimental studies are designed to investigate the pathophysiological basis for the observation that whole body X-irradiated conventional mice rendered germfree by antibiotic "decontamination" have a lower incidence and severity of graft-versus-host (gvh)-disease after allogeneic bone marrow transfusion than conventional mice. On the basis of these results, experiments were designed to answer 2 questions:

1. Do "decontaminated" allogeneic bone marrow chimeras tolerate reassociation with a conventional flora?
2. Do "decontaminated" allogeneic bone marrow chimeras restore their hemopoietic stem-cell pool to an extent observed in isogenic chimeras?

Other problems of interest, such as the immunological competence of these chimeras and its origin are being under study at the present time. To study the first question, 20 "decontaminated" bone marrow chimeras (170 days after whole body X-irradiation and bone marrow grafting) were used. "Reconventionalization" was carried through by stepwise reassociation with a gastro-intestinal microflora typical for CBA mice in our animal breeding facility. During an initial period of 49 days, anaerobic bacteria were introduced together with food. Thereafter, a suspension of mixed faecal bacteria was given. On the basis of a careful bacteriological analysis, it was shown that a normal microflora was re-established within 7 days. None of these bone marrow chimeras developed signs of infection or died. After further observation during 161 days, the animals were

sacrificed, but there was no macroscopical nor microscopical evidence of gvh-disease. In order to study the second question, 85 "decontaminated" CBA/CA mice were given a lethal whole body irradiation and transfused with 1×10^7 cells of C57Bl bone marrow. Every 2 weeks, 4 transplanted mice were killed and the number of colony forming units (CFU-s) in bone marrow and spleen measured by the exocolonizing assay (Till and McCulloch-method). C57Bl mice served as CFU-s recipients. In addition, the soft agar culture method was used to measure the recovery pattern of those cells which give rise to granulocytic colonies in that system (CFU-c determination). The preliminary results indicate that a normal stem cell content of the bone marrow is reached by week 9. The spleen shows an overshoot of the number of CFU-s and CFU-c between the 2nd and 4th week. By the 9th week the number of spleen stem cells had returned to normal values. At that time, all blood cell parameters also had normalized. This extent of marrow regeneration was found to be comparable to that seen after isogeneic transplantation when 0.5×10^6 bone marrow cells were given.

The clinical studies continue to be concerned with the possibilities and limitations of inducing and maintaining a gnotobiotic state in patients with hemopoietic failure by means of antibiotic treatment.

This study is performed in a cooperative international trial within the EORTC (European Organization for Research on Treatment of Cancer) Gnotobiotic Project Group in order to increase the number of patients to that necessary to evaluate the data statistically. The three groups to which patients are randomised are:

- A. Reverse isolation and decontamination of the microbial flora
- B. Reverse isolation only
- C. Treatment on the open ward

In 1973, 19 patients were subjected to this trial, 4 in group A, 9 in group B and 6 in group C. Eleven patients had to be rejected owing to lack of further capacity of isolators. In the cooperative trial

the overall number of patients admitted to the study reached 120 in 1973. The cooperative trial will be terminated with 150 patients, a number that will be achieved at the end of 1974.

So far, it has been seen that patients in isolation can acquire dramatic septicemias as well as those on the open ward. These septicemias are caused by germs of the indigenous microflora of these patients. In group A patients, those who are isolated and decontaminated by non-absorbable antibiotics, septicemias occur very rarely. However, in a few instances septicemias have been detected either due to bacteria with resistance to all given antibiotics or bacteria originating from hidden niches, for instance from chronic tonsillitis. One may conclude that the decontamination by non-absorbable antibiotics is not sufficient but has to be improved by treatment of systemic antibiotics also. At the present time there is evidence that pulmonary infections occur less frequently in isolated patients (group A, B) than in patients on the open ward. As a preliminary result this indicates that aerogenic infections play a role in the transmission of infectious diseases during hospital treatment of patients with high susceptibility to infection.

Ergebnisse des Projektes Nr. 4

Leiter des Projektes und wissenschaftliche Mitarbeiter :

B. Kubanek with O. Bock, E. Bock, E.B. Harriss, W. Heit and W. Schreml

Titel des Projektes :

Comparative investigations on the damage and repair of hemopoietic cells by ^3H -thymidine or radiomimetic substances with particular reference to the uncommitted and committed stem cell compartments.

Results :

As formulated in the 1972 report, "the marked differences between suicidal doses of ^3H -TdR and hydroxyurea (HU) are probably at present best explained by a prolonged cell death owing to reutilisation of ^3H -labelled DNA breakdown products from initially heavily labelled cells".

This working hypothesis has been pursued in 1973 by studying the fate of ^3H -TdR in combination with HU in plethoric mice. Continuous death of labelled cells after suicidal ^3H -TdR is indicated by more rapid decline of total DNA-bound radioactivity in bone marrow and spleen cells compared to control animals, which had received tracer doses of ^3H -TdR. Extensive and rapid loss occurred in HU-treated animals showing an instantaneous and highly effective killing of ^3H -TdR labelled cells. After double labeling of DNA with ^3H -TdR and ^{125}I -deoxyuridine (^{125}I -UdR), the ratio of DNA-bound ^{125}I to ^3H was measured as a parameter for the degree of reutilisation, since ^{125}I -UdR is reutilised only to a minor degree. The ration of DNA-bound ^{125}I to ^3H declined more rapidly after suicidal ^3H -TdR compared to controls as an indication of tritium reutilisation. After hydroxyurea, reutilisation was completed within the first 12 h after drug administration, as indicated by the initial decline of the ^{125}I to ^3H -ratio, which levelled off after the first 12 h.

These finding give a clear indication of significant tritium reutilisation and explain in part the slow recovery of different stem cell compartments after suicidal ^3H -TdR on the basis of prolonged tritium reutilisation as compared to the fast recovery which follows the rapid killing action of HU.

Ergebnisse des Projektes Nr. 5

Leiter des Projektes und wissenschaftliche Mitarbeiter :

G. Lucarelli, A. Porcellini, T. Izzi, M. Galimberti, M. Tomassucci, A. Fontebuoni, A. Bravetti and E. Guardato

Titel des Projektes :

Comparative study on characterization of fetal and neonatal stem cell compartment as a basis for the studies on the regulation of hemopoietic cell kinetics.

Results :

It has been the purpose of experimental studies in 1973 on newborn and adult rats to attempt a further characterization of the function and regulation of the hemopoietic stem cell pools. The present studies were conducted in newborn rats because earlier investigations had established the fact that erythropoiesis in the newborn must be under entirely different regulatory mechanisms than in the adult, the change from neonatal to adult type regulation being around the 3 - 4th week after birth. In contrast to the adult rat, the newborn rat was found not to react to nephrectomy with a decreased red cell production which was interpreted to mean that there is extrarenal erythropoietin production in the newborn rat. Hypertransfusion does not - like in the adult rat - suppress erythropoiesis. Starvation in the adult rat results in a marked depletion of erythropoiesis. In the newborn animal, the hematological changes seen are different : the findings, including Fe 59 incorporation into red cells, indicate a decrease in red cell production on day 10 after birth and a prolonged transit time through the bone marrow. These changes are obvious despite the fact that red cell precursors are present in the marrow. As a matter of fact, in the starved newborn animal, there appears to be an influx from the stem cell compartment into the differentiated red cell precursor compartment. From these results, the conclusion was entertained, that starvation in newborn as well as in the adult lowers the tissue oxygen demand and thus erythropoietin production. In the adult, stem cells are blocked from entering

the erythropoietic precursor compartment, resulting in a severe depletion of erythropoiesis. In the newborn animal, however, there is a reduction in the speed of influx of stem cells into the precursor compartment as well as reduced speed of red cell precursor maturation due to the lack of erythropoietin. If erythropoietin was given (2 units per day for 3 days to newborn starved rat) the red cell production can be brought back to nearly normal levels.

It is concluded that the committed erythroid stem cell compartment is in the newborn animal in part independent of erythropoietin. Erythropoietin in these animals exerts its action mainly by controlling the rate of cell maturation, probably by the control of the rate of hemoglobin synthesis. On the basis of these experiments, studies were initiated to see whether exogenous erythropoietin acts on erythroid proliferation or on erythroid maturation. Therefore, experiments were designed to use hydroxyurea (HU) as a means to kill cells in DNA synthesis and colchicine to block cells in mitosis. In the 10 day old animals given 100 mg HU 24 hours before sacrifice, no marked difference was seen in the number of nucleated marrow cells between starved animals and their controls: In both groups, the erythropoietic depletion was of similar extent. In the colchicine experiments, a marked difference in the accumulation pattern of mitoses was seen between the normal and the standard animals, compatible with the assumption of a decreased rate of proliferation and maturation after starvation. If erythropoietin is given, the rate of erythroid proliferation is partially restored and the curve of mitotic accumulation similar to the normal controls.

These experimental results are of great help in understanding the mechanisms of action of erythropoietin in bone marrow regeneration and hence are of central importance to the fields of basic studies in this contract.

REFERENCES :

SCHREML, W., O. BOCK, E. BOCK, W. HEIT and B. KUBANEK :
Different action of tritiated thymidine and hydroxyurea
on murine stem cells.
Submitted to "Cell and Tissue Kinetics".

HOELZER, D., E. KURRLE, W. CALVO and E.B. HARRISS :
Untersuchungen zur funktionellen und morphologischen Charak-
terisierung der hämopoetischen Stammzelle des Menschen im
peripheren Blut.
Presented at the Deutsch-Österreichischer Hämatologenkongress,
Wien, 21. - 23.3.1974.

GOLDMANN, S.F. and H.D. FLAD :
The expression of the major histocompatibility complex (MHC)
of beagles in 3 test systems : Tissue typing, mixed lympho-
cyte culture (MLC) and cell mediated lympholysis (CML).
Presented at the 5th Annual Meeting of the Deutsche Arbeitsge-
meinschaft für Histokompatibilitätstestung, Giessen, 5.-6. Octo-
ber, 1973. Submitted to Zeitschr. f. Immunitätsforschung.

GOLDMANN, S.F. and H.D. FLAD :
Histocompatibility testing in dogs. I. A semi-micro mixed lympho-
cyte culture (MLC) technique for histocompatibility matching
in dogs.
Submitted to "Tissue Antigens".

GOLDMANN, S.F., K. v. LORINGHOVEN, H.P. SCHNAPPAUF, R.P. HUGET
and H.D. FLAD :
Histocompatibility testing in dogs. II. Leukocyte typing in re-
lation to the mixed lymphocyte culture (MLC) reactivity.
Submitted to "Tissue Antigens".

FLIEDNER, T.M. und H.D. FLAD :
Therapiemodell der strahleninduzierten Knochenmarkinsuffizienz
unter Verwendung tiefkühlkonservierter Blutstammzellen.
Wehrmed. Monatsschr. 17, Nr. 10, 322 - 324, 1973

DIETRICH, M. :
The role of gnotobiotic care in the chemotherapy of acute leukemia.
Presented at the Annual Meeting EORTC, Paris, June 29, 1973.
Submitted to Springerverlag.

DIETRICH, M. :
Barrierfunction and ventilation: Isolation systems in human
patients.
In : "Airborne Transmission and Airborne Infection". Eds. J.F.
Ph. Hers and H.C. Winkler, Oosthoek Publ. Comp. Utrecht, The
Netherlands, 532 - 533, 1973.

DIETRICH, M. :

Conventionalization after germ free state : Clinical experiences.
In : "Airborne Transmission and Airborne Infection". Eds. : J.F. Hers and K.C. Winkler, Oosthoek Publ. Comp. Utrecht, The Netherlands, 553, 1973.

DIETRICH, M. :

Krankenbehandlung im Plastikzelt.
Der Krankenhausarzt, 46, Nr. 10, 1973

SCHREML, W., R.J. HAAS, F. PLANAS-BOHNE :

Distribution and dosimetry of tritium in newborn rats after in utero exposure to $^3\text{H-TdR}$.
Radiation Research (in press).

KOVACS, P., C. BRUCH, E. HERBST and T.M. FLIEDNER :

In vitro colony forming units (CFU-c) collected from the dog blood :
Their concentration before, during and after single and repeated leukaphereses.
Submitted to Blood.

VAN DER WAAIJ, D., M. DIETRICH :

Evaluative study of patients with acute leukemia under gnotobiotic conditions by the Gnotobiotic Project Group of the European Organization for Research on Treatment of Cancer (EORTC).
In "Germfree Research", Ed. J.B. Heneghan, Academic Press, New York and London, pp. 49 - 53, 1973.

DIETRICH, M., T.M. FLIEDNER :

Gnotobiotic care of patients with immunologic deficiency diseases.
Transpl. Proc. 5, 1271 - 1277, 1973.

SCHREML, W., O. BOCK, B. KUBANEK, W. HEIT, E. BOCK, E.B. HARRISS :

Different action of suicidal tritium thymidine and hydroxyurea.
Presented at the ISEH Meeting, Paris, June 1973, Journal Exp. Haemat. (in press).

FLIEDNER, T.M., C. BRUCH, W. CALVO, H.-D. FLAD, E. HERBST, E. HÜGL, R. HUGET, B. NELSON and H.P. SCHNAPPAUF :

Pattern of early hemopoietic regeneration in lethally irradiated dogs after transfusion of fresh and cryopreserved blood mononuclear leukocytes.

Presented at the ISEH Meeting, Paris, June 1973, J. Exp. Haemat. (in press).

HEIT, H. and T.M. FLIEDNER :

The possible role of the gnotobiotic status of allogeneic bone marrow recipients for the clinical course of secondary disease.
Presented at the ISEH Meeting, Paris, June 1973, J. Exp. Haemat. (in press).

NELSON, B., W. CALVO, E. HERBST, C. BRUCH, H.P. SCHNAPPAUF and T.M. FLIEDNER :

Repopulation of dog lymphnodes after 1200 rads total-body irradiation and i.v. administration of autologous mononuclear blood cells.
Presented at the ISEH Meeting, Paris, June 1973, J. Exp. Haemat. (in press).

BRUCH, C. and P. KOVACS :

The role of phagocytic cells in marrow cell and blood leukocyte suspensions for colony forming cells in culture (CFU-c) stimulated by serum CSF.

Presented at the ISEH Meeting, Paris, June 1973, J. Exp. Haemat. (in press).

BOCK, E., W. HEIT, O. BOCK, B. KUBANEK, E.B. HARRISS :

Stem cell regulation in the mouse fetus.

Presented at the ISEH Meeting, Paris, June 1973. J. Exp. Haemat. (in press).

FLIEDNER, T.M. :

Kinetik und Regulationsmechanismen des Granulozytenumsatzes. Schweiz. med. Wschr. 104, 98 - 107, 1974.

KURRLE, E., D. HOELZER, R.J. HAAS, T.M. FLIEDNER :

Evidence of stem cell properties of small lymphocytes in rats. 2nd Meeting of the European and African Divisions of the International Society of Haematology, Prague, 27 - 29 August 1973.

HARRISS, E.B. and D. HOELZER :

Studies on the anaemia of an experimental rat leukaemia.

Presented at the 2nd Meeting of the European and African Divisions of the International Society of Haematology, Prague, 27 - 29 August 1973.

DIETRICH, M., T.M. FLIEDNER and D. KRIEGER :

Germfree technology in clinical medicine : production and maintenance of gnotobiotic states in man.

In : "Germfree Research", pp. 21 - 30, Ed. J.B. Heneghan, Academic Press, Inc., New York and London, 1973.

HAAS, R.J., H.D. FLAD, T.M. FLIEDNER and I. FACHE :

Correlation between cytokinetically resting lymphocytes and bone marrow restoration : Experiments using a discontinuous albumin gradient.

Blood, 42, 209 - 218, 1973.

KUBANEK, B., O. BOCK, W. HEIT, E. BOCK and E.B. HARRISS :

Size and proliferation of stem cell compartments in mice after depression of erythropoiesis.

In : "Haemopoietic Stem Cells", CIBA Foundation Symposium 13 (new series). pp. 243 - 262. Ed. G. Wolstenholme, Associated Scientific Press, Amsterdam, 1973.

HAAS, R.J., W. SCHREML and T.M. FLIEDNER :

Die Wirkung von Tritium Wasser auf die Entwicklung der Ratte nach kontinuierlicher Infusion während der Schwangerschaft
Blood (in press)

HAAS, R.J., W. SCHREML, T.M. FLIEDNER and W. CALVO :
Der Effekt von Tritium Wasser auf die Entwicklung der Ratten-
Oozyten nach kontinuierlicher Infusion während der Schwanger-
schaft
Int. S. Radiat. Biol. 23, 603 - 609, 1973.

HAAS, R.J. and I. FACHE :
Zytokinetische Untersuchungen zur Proliferationsaktivität von
Mastzellen im regenerierenden Knochenmark der Ratte.
Blut 26, 180 - 187, 1973

VENERANDI, C., A. FONTEBUONI, V. GUARDATO, A. PROCELLINI,
G. LUCARELLI :
Effetto della actinomicina-D sulla eritropoiesi del ratto neo-
nato.
Haematologica, Fasc. IX-X, Vol. LVIII, 1973.

LUCARELLI G., A. PORCELLINI and T. IZZI :
Studi sulla regolazione della eritropoiesi. Nota I. Un modello
sperimentale di eritropoiesi inefficace, il ratto neonato a
digiuno.
Lavoro presentato al XXIV Congresso Soc. It. Ematologia, Pavia
Settembre 1973.
Haematologica (in press)

GUARDATO, V., R. ZERBINATI, M. TOMASUCCI, A. PORCELLINI,
G. LUCARELLI :
Studi sulla regolazione della eritropoiesi : Nota II. Effetto
della idrossiurea sulla eritropoiesi del ratto neonato.
Lavoro presentato al XXIV Congresso Soc. It. Ematologia, Pavia
Settembre 1973, Haematologica (in press)

LUCARELLI G., V. GUARDATO, A. PORCELLINI, T. IZZI :
Studi sulla regolazione della eritropoiesi. Nota III. Effetto
della colchicina sulla eritropoiesi del ratto neonato.
Lavoro presentato al XXIV Congresso Soc. It. Ematologia, Pavia
Settembre 1973. Haematologica (in press)

Contractant van de Commissie : Nederlandse Organisatie voor Toegepast-
Natuurwetenschappelijk Onderzoek TNO

Nummer van het contract : 088 - 72 - 1 - BIA C

Hoofd van de researchteams : Prof. D.W. van Bekkum

Algemeen onderwerp van het contract : Consequences of radiation exposure,
prevention and treatment of pathological effects

Algemene omschrijving van de uitgevoerde werkzaamheden :

Experiments on histocompatibility typing in monkeys were continued with the ultimate objective of identifying factors which determine development and severity of graft-versus-host (GvH) disease following bone marrow grafting. Host-donor matching for serologically defined (SD) antigens was greatly improved by the production of numerous new reagents raised in related animals, which resulted in recognition of 80-90% of all antigens versus 50% previously. Furthermore, matching procedures have been extended by introducing the MLC test to match for identity for so-called lymphocyte defined determinants (LD matching). The significance of these two matching procedures had to be evaluated in skin grafting experiments, prior to their evaluation in bone marrow transplantation.

A limited number of genotypically identical monkey siblings have been employed as host-donor pairs in bone marrow grafting. The scarcity of such combinations forced us to continue these studies in dogs, where large litters are available. In order to define the optimal conditions for bone marrow transplantation in dogs, a radiation dose mortality study was performed and the number of bone marrow cells from DL-A identical sibling donors required to establish takes, was determined.

The experiments concerned with the morphological identification of haemopoietic stem cells (HSC) in monkey and human bone marrow were concluded and the results have been published.

In vitro methods for cloning of HSC were employed to investigate bone marrow from aplastic and leukemic patients, to evaluate the feasibility of employing cadaver bone marrow for grafting and to explore the processing and HSC of fetal livers from monkeys and humans.

Attempts to develop methods for mitigating GvH reactions were continued in mice, rats, monkeys and dogs.

Resultaten van het project no. 1

Hoofd van het team en wetenschappelijke medewerkers : D.W. van Bekkum
and K.A. Dicke/ I. Betel.

Titel van het project : Bone Marrow Transplantation.

Beschrijving van de resultaten :

The results of skin grafting experiments between monkeys suggest that both SD and LD matching are equally important for prolongation of graft survival, which finding indicates that both parameters have to be investigated in bone marrow grafting. A few bone marrow grafts performed between genotypically identical monkey siblings resulted in a significantly prolonged survival and less severe GvH reactions as compared with non-related allogeneic grafts.

X-irradiation facilities were set up for beagle dogs, to provide uniform whole body irradiation with a dose rate of 18 rad/min. Under these conditions an $LD_{50/30 \text{ days}}$ of appr. 350 rad was registered, while intestinal death was observed following doses in excess of 750 rad. In a series of dogs irradiated with 750 rad, consistent takes were obtained after grafting of $2-4 \times 10^8$ bone marrow cells/kg body weight from DL-A identical MLC negative sibling donors. Genetic markers employed to identify takes include polymorphic red and white cell enzymes, red and white cell membrane antigens and sex chromosome markers in bone marrow cells. The incidence of GvH in this series of 17 animals was 60%. Occurrence of GvH was not correlated with incompatibility for the canine secretory allo-antigen system as defined by Zweibaum and Feingold (1973). High values for the MLC third party disparity ratio (Park and Good, 1972) were connected with occurrence of GvH, but low values were obtained in equal frequency from host-donor combinations with and without GvH. Our results also exclude a donor specific property (e.g. high content of immune competent cells in the marrow) as the sole cause of GvH. In contrast to the results published by Storb et al. (1973), GvH reactions were mild in our dogs and have not caused death so far (40-180 days survival). Studies aimed at identifying the factors determining the appearance of GvH in these host-donor combinations will be continued.

The in vitro culture of bone marrow from aplastic patients has provided certain patterns which seem to be of prognostic significance. Results obtained in collaboration with Dr. U.W.Schaefer (Essen, Germany) on cadaver

marrow of mice and man show a rapid loss of viability of HSC, which seemed to exclude the possibility of employing cadavers as a source of marrow for grafting.

So far attempts at prevention of GvH by in vitro treatment of bone marrow with ALG or in vivo treatment of bone marrow recipients with enhancing anti-serum have been unsuccessful.

Experiments with liver stem cells from mouse and human fetuses have yielded results justifying renewed attempts for application of fetal HSC in restoration of immune deficient babies.

References

- Park, B.H., and Good, R.A., Proc.Natl.Acad.Sci., 69, (1972), 1490.
Storb, R., et al., Transplantation, 15, (1973), 92.
Zweibaum, A., et al., Tissue Antigens, 3, (1973), 163.

List of publications

- Bekkum, D.W. van, ALG in the prevention of acute graft-versus-host reactions following allogeneic bone marrow transplantation. Behring Institute Mitteilungen, no. 51, September 1972. ALG therapy and standardization Workshop held at Bad Soden, 23-25 April, 1972. Ed.by: F.R.Seiler and H.G.Schwick, Session 6, Bone marrow transplantation. Marburg, Behringwerke AG, 1972, p. 159-162.
- Schaefer, U.W., and Dicke, K.A., In-vitro und In-vivo-studien mit tiefgefrorenem Knochenmark von Nagetieren und Primaten. Med.Welt., 23, (1972), 3.
- Balner, H., D'Amaro, J., et al., Major histocompatibility system of rhesus monkeys, RhL-A. In: Medical Primatology 1972. Proc.3rd Conference Exp. Medicine and Surgery in Primates, Part II. Ed.by: E.I.Goldsmith and J.Moor-Jankowski. Basel, S.Karger, 1972, p. 78-91.
- Schaefer, U.W., Dicke, K.A., and Bekkum, D.W. van, Bone marrow transplantation in rhesus monkeys. In: ibidem, p. 142-148.
- Schaefer, U.W., and Dicke, K.A., Proliferationspotential von tiefgefrorenem Knochenmark in vitro und in vivo. In: Leukämie. XV Kongress der Deutschen Gesellschaft für Hämatologie in Köln, 3-6 Oktober 1971. Ed.by: R.Gross and J.v.d.Loo. Berlin, Springer Verlag, 1972, p. 229-233.
- Dicke, K.A., Separation techniques for haemopoietic cells based on differences in volume and density. In: Methodological developments in biochemistry, vol. 2: Preparative techniques. Ed.by: E.Reid. London, Longman, 1973, p. 175-184.

- Balner, H., D'Amaro, J., Toth, E.K., et al., The histocompatibility complex of rhesus monkeys. Relation between RhL and the main locus controlling reactivity in mixed lymphocyte cultures. *Transplantation Proc.*, 5, (1973), p. 323-329.
- Dicke, K.A., and Bekkum, D.W. van, Transplantation of haemopoietic stem cell (HSC) concentrates for treatment of immune deficiency disease. In: *Micro-environmental Aspects of Immunity*, ed.by: B.D. Jankovic and K.Isakovic. New York, Plenum Press, 1973, p. 337-342.
- Dicke, K.A., Schaefer, U.W., and Bekkum, D.W. van, The use of stem cell concentrates as bone marrow grafts in man. *Transplantation Proc.*, 5, (1973) p. 909-912.
- Dicke, K.A., Noord, M.J. van, and Bekkum, D.W. van, Attempts at morphological identification of the haemopoietic stem cell in rodents and primates. *Exp.Hemat.* 1 (1973), 36.
- Dicke, K.A., Noord, M.J. van, Maat, B., et al. Attempts at morphological identification of the haemopoietic stem cell in primates and rodents. In: *Haemopoietic stem cells. Ciba Foundation Symposium 13 (new series)*. Amsterdam, Elsevier, 1973, p. 47-69.
- Bekkum, D.W. van, and Roodenburg, J., Antidonor immunologic reactions of long-standing radiation chimeras. *Transplantation Proc.* 5, (1973), 881.
- Dicke, K.A., Noord, M.J. van, Maat, B, et al., Identification of cells in primate bone marrow resembling the hemopoietic stem cell in the mouse. *Blood*, 42, (1973), 195.
- Balner, H., Dersjant, W., Vreeswijk,W. van, et al., The leukocyte antigens of rhesus monkeys and chimpanzees. Current state and results of the first primate histocompatibility workshop. In: *Histocompatibility Testing,1972*. Ed.by: J.Dausset and J.Colombanie. Munksgaard, Copenhagen, 1972, p.39-48.
- Dicke, K.A., Engh, G. van den, and Bekkum, D.W. van, Evidence suggesting identity of CFU-spleen and cells producing colonies in a specially designed tissue culture system. *Exp Hemat.* 1 (1973), 98.
- Balner, H., Gabb, B.W., Toth, E.K., et al., The histocompatibility complex of rhesus monkeys. I. Serology and genetics of the RhL-A system. *Tissue Antigens*, 3, (1973), 257.
- Balner, H., and Toth, E.K., The histocompatibility complex of rhesus monkeys. II, A major locus controlling reactivity in mixed lymphocyte cultures. *Tissue Antigens*, 3, (1973), 273.

- Balner, H., Current knowledge of the histocompatibility complex of rhesus monkeys. (A brief review). *Transplantation Reviews*, 15, (1973), p. 50-61.
- Ford, A.C., Speltie, T.M., and Hendriks, W.D.H., Studies on the prevalence of salmonella serotypes in nonhuman primates. *Lab.Anim.Sci.*, 23, (1973), p. 649-652.

Contractant de la Commission : Institut Jules Bordet.

N° du Contrat : 088-72-1 BIAC.

Chef du Groupe de Recherche : Prof. H.J. Tagnon.

Thème général du contrat : " Kinetics and regulation of cell proliferation
of normal and pathological bone marrow cells " .

The destruction of cells by physical or chemical means is a way to study the regulatory mechanism which exists at the level of the cell and at the level of a cell population. The cancer chemotherapeutic agents are very toxic for the bone marrow and by affecting the cell more or less specifically in one or another phase of the cell cycle makes it possible to study the regulatory mechanisms of bone marrow regeneration.

The different human leukemia deviations from the normal bone marrow may represent to some extent simplifications of the normal situation. Acute myeloblastic leukemia, for instance, is characterized by an increased population of cells highly reminiscent of the normal bone marrow myeloblasts. These leukemic cells may be used to study normal regulatory mechanisms.

In project n° 1 the possibility to trigger cell proliferation of myeloid cell in the bone marrow by cancer chemotherapy was investigated. This was studied in cases of acute leukemia and the behavior of the leukemic blasts was investigated. Cytosin arabinoside was the chemotherapeutic agent used. It was found to increase considerably the ³H thymidine uptake by the leukemic cells. However, other techniques did indicate that this uptake was not due entirely to an increase of the proliferative activity of the leukemic cells.

In project n° 2 the factors affecting the release of myeloid cells from the bone marrow to the peripheral blood were investigated. This study was performed in cases of acute leukemia and the passage of leukemic " blasts " was investigated. The passage was found to be dependent on :

- a) the size of the LB ;
- b) the number of LB in the bone marrow ;
- c) the number of LB in the peripheral blood.

Résultats du projet n° 1.

Chef du projet et collaborateurs scientifiques : P. Stryckmans,
L. Debusscher,
G. Delalieux.

Titre du projet : " Study of the factors determining leukaemic cell
proliferation ".

Chemotherapy by decreasing the size of the leukaemic cell population has been suggested as a mean to increase the proliferative activity of the surviving cells. This has been reported after the use of ARA-C in acute human leukaemia and interpreted as the result of the recruitment of non-proliferating cells into the cell cycle.

To test the validity of this concept in acute leukaemia, ARA-C has been given as treatment, 100 mg/BSA iv, either once or repeatedly every 12 hours for 7 to 10 days to patients with acute leukaemia.

An injection of $^3\text{HTdR}$ (0.1 mC/kg BW) was given either 1 or 24 hours before the first injection of ARA-C. Samples of peripheral blood and bone marrow were taken 1 hour after the injection of $^3\text{HTdR}$ and thereafter serially including a sample just before each injection of ARA-C. All samples were processed as follows : smears were made for autoradiography (ARG) to determine the % of in vivo labeled cells and the rest of each sample was incubated in vitro with $^3\text{HTdR}$ (at a very high concentration to distinguish it from the in vivo labeling) before ARG were made for the determination of the fraction of cells in DNA synthesis.

Out of 9 leukaemic patients treated by ARA-C every 12 hours, 3 patients (one of them 2 times) showed an increase of the in vitro $^3\text{HTdR}$ labeling index of the bone marrow leukemic cells only, as a consequence of the treatment. The labeling index of the cells did not change.

In the patients who showed a considerable increase of the in vitro $^3\text{HTdR}$ labeling index as a consequence of treatment, the DNA content of the leukemic cells was measured by microdensitometry after Feulgen staining. This method showed that when the labeling index was at its maximum as a consequence of ARA-C, the fraction of cells between 2 and 4 N DNA content was increased. However, this increase was considerably less important than the increase of the labeling index. In other words the cells found in S by microdensitometry

did not account for the considerable increase of " S " cells as determined by $^3\text{HTdR}$ uptake.

It appears thus that the increased uptake of $^3\text{HTdR}$ by the leukemic cells during ARA-C treatment does not certainly reflect cell proliferation and therefore recruitment. Although unlikely, repair DNA synthesis must be ruled out.

Résultats du projet n°2.

Chef du projet et collaborateurs scientifiques : P. Stryckmans,
L. Debusscher,
D. Gangji.

Titre du projet : Study of the factors affecting the passage of myeloid cell
from the bone marrow into the blood.

This was studied on leukemic patients and the passage of the leukemic myeloblast was investigated.

Tritiated thymidine ($^3\text{HTdR}$) was given i. v. to leukemic patients (0.1 mC/kg BW). This labels the marrow leukemic blasts (MLB) in " S " and almost no blood leukemic blast (BLB). During the subsequent hours the increase of the BLB labeling index (IL) reflects the input of MLB. This increase is not seen when either daunomycin or vincristine is given at the same time as $^3\text{HTdR}$ but an increase is seen when one of these drugs is given 24 hours after $^3\text{HTdR}$. The passage thus appears to be cell-cycle-phase dependent and arguments are presented to consider it as cell-size-dependent (1).

To investigate whether the release of MLB from the marrow is dependent upon the number of MLB, the T 1/2 of BLB was determined in 5 patients after their labeling by ^3H cytidine. The number of BLB was only slightly correlated to their T 1/2, therefore highly correlated to the input of MLB. Furthermore no correlation was found between the $^3\text{HTdR}$ IL of the MLB and the number of BLB. Thus the number of MLB released to the blood appears to be related to the total number of MLB.

The third factor investigated was the number of BLB. After labeling of a fraction of the BLB by ^3H cytidine, 90% of the BLB were removed by an IBM blood cell separator. This caused a massive input of blasts indicating that the number of BLB probably also affects the release of MLB.

References.

1. P.A. Stryckmans, J. Manaster, F. Lachapelle and M. Socquet. Mode of action of chemotherapy in vivo on human acute leukemia. J. Clin. Invest. 52, 126, 1973.
2. J. Manaster, J. Frühling and P. Stryckmans. Kinetics of lymphocytes in chronic lymphocytic leukemia. I. Equilibrium between blood and a " readily accessible pool ". Blood, 3, 425.
3. P. Stryckmans, J. Manaster, G. Delalieux. Le traitement des leucémies aiguës. Essais cliniques contrôlés et faits expérimentaux en vue d'une administration plus rationnelle des médicaments antileucémiques. Revue Médicale (Liège) 28, 434, 1973.
4. P. Stryckmans, J. Manaster, T. Peltzer, M. Socquet and G. Vamecq. Cell proliferation in chronic myeloid leukemia. From : Thyroid Tumours Lymphomas Granulocytic leukemia. Proceedings of the II Padua Seminar on Clinical Oncology. October, 1972. Piccin Medical Books.
5. P.A. Stryckmans, P.M. Lurie, J. Manaster and G. Vamecq. Mode of action of chemotherapy in vivo on human acute leukemia. II. Vincristine. Europ. J. Cancer 9, 613, 1973.

Vertragspartner der Kommission:

Gesellschaft für Strahlen- und Umweltforschung,
Institut für Hämatologie

Nr. des Vertrages: 089-72-1 BIAD

Leiter der Forschungsgruppe: Priv.-Doz. Dr. Stefan Thierfelder

Allgemeines Thema des Vertrages:

Strahlenbiologische Hämatologie und Immunologie (Proj. 1-3)

(Proj. 4-7 über Nuklearmedizinische Hämatologie sind unter Kapitel V "Forschungstätigkeit Anwendungen Medizin" aufgeführt. Am Schluß dieses Teils des Berichtes befindet sich eine Aufstellung der Publikationen.

Allgemeine Darstellung der durchgeführten Arbeiten:

The projects of the research group in Munich continued their studies on the analysis and treatment of the consequences of radiation exposure. During 1973 the new facilities for experimentation on dogs of the GSF were taken over and studies on histocompatibility and conditioning treatments of dogs were started. In cooperation with Dr. Vriesendorp, TNO Rijswijk, the first 7 specificities of the MLC polymorphism were defined in the dog. Using fractionated cyclophosphamide several complete chimaeras could be achieved after DL-A compatible bone marrow transplantation. A meeting on the study of canine bone marrow transplantation was held in Ulm and half a year later in Munich where further cooperation between the EURATOM partners in Ulm, Rijswijk and Munich was planned along these lines.

Our observation that acute secondary disease can be suppressed in mice with anti-T-cell globulin was confirmed in large series. The T-cell antigen was localized with electronmicroscopy using antibodies labelled with peroxidase.

In man the frequency of the first MLC-specificity Pi could be established. The follow up study of radiation induced changes in the bone marrow of partially irradiated patients was continued. Our method for determining the time of DNA synthesis of individual bone marrow cells was applied to various types of anemias and helped to perform a comprehensive and detailed analysis of the kinetics of erythroblast proliferation in various diseases.

Ergebnisse des Projekts Nr. 1

Leiter des Projekts und wissenschaftliche Mitarbeiter:
S. Thierfelder, H.-J. Kolb, J. Bau und Th. v. Arnim

Titel des Projekts:

Partial body irradiation and other non-lethal conditioning treatments of bone marrow recipients.

The study on the induction of chimaerism in allogeneic mice by ALS and partial body irradiation was completed. 0.25 ml ALS were given for 6 days followed by 900 R (^{137}Cs , 60 r/min) applied to the lower or upper part of the recipient conditioned for chimaerism in allogeneic, H_2 identical donor-recipient combinations. About 90 % of donor type mitoses were found in the irradiated parts of the ALS-treated recipient, about 10 % in the shielded parts (s. Fig. 1). This type of partial chimaerism persisted for more than 100 days. The combination of ALS and partial body irradiation represents a conditioning treatment which is not lethal in the absence of a subsequent bone marrow transplantation. It induced, however, an only transitory chimaerism in H_2 incompatible recipients.

In mammals xenogeneic chimaerism was only obtained in mice. While rat marrow could be transplanted to irradiated mice, no information existed about the engraftment of murine marrow in rats. We therefore studied the kinetics of xenogeneic engraftment in rats. A dose of 900 R given to Wistar rats led to a transitory engraftment of murine marrow. Donor cells in bone marrow, spleen and peripheral blood were found by chromosomal analysis and alkaline phosphatase staining.

With one exception all the rats grafted with murine marrow had died or reverted to rat type hemopoiesis by day 20 after transplantation.

A potentiation of the immunosuppressive dose of the conditioning irradiation was obtained with a 6 days' treatment of 2.0 ml ALS/day. This combination of ALS and irradiation led to a persisting mouse type hemopoiesis, with rats dying of chronic secondary disease 20 to 40 days after transplantation.

The addition of thymectomy to ALS and sublethal irradiation led to a potentiated conditioning effect, indicating that the failure of rats irradiated with 900 R to accept murine marrow was indeed due to insufficient immunosuppression. Both studies in this project underline the importance of an efficient conditioning regimen of strongly histoincompatible recipients.

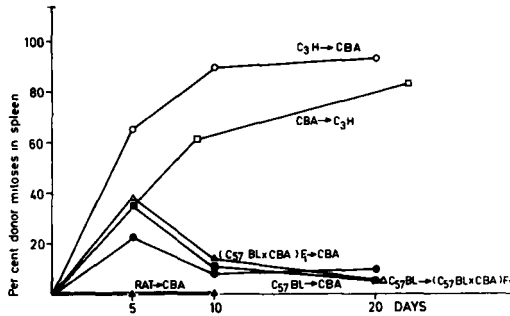

Chimaerism in the spleens of ALS-treated partially irradiated recipients of allogeneic bone marrow as determined by chromosomal analysis.

Ergebnisse des Projekts Nr. 2

Leiter des Projekts und wissenschaftliche Mitarbeiter:
H.-J. Kolb, I. Rieder, H. Grosse-Wilde, W. Ruppelt
und S. Thierfelder

Titel des Projekts:

Combined conditioning treatment (irradiation and/or
cyclophosphamide and/or ALS) of dogs.

During 1973 the canine model of bone marrow transplantation was set up. A series of investigations was begun dealing with the conditioning of beagles with cyclophosphamide. Maximal numbers of bone marrow cells that could be obtained from a living donor were used.

The dog is known for its sensitivity to the toxic side effects of cyclophosphamide. We therefore distributed the total conditioning dose over 3 days (3 x 40 mg/kg). Toxicity studies revealed that higher doses were lethal. First trials of conditioning DL-A and MLC identical allogeneic recipients with cyclophosphamide led to complete chimaerism in 2 dogs as to chromosomal analysis 8 weeks after transplantation, and partial chimaerism in 2 dogs 6 months after transplantation. Further studies will evaluate the effect of buffy coat given together with the marrow.

Ergebnisse des Projekts Nr. 3

Leiter des Projekts und wissenschaftliche Mitarbeiter:
Prof. Dr. R. Burkhardt, Dr. E. Beil und Dr. A. Kronseder

Titel des Projekts:

Bone marrow histology in patients treated with radiation, isotopes and radiomimetic agents.

1. In pursuit of the previous study of bone marrow changes in polycythemia vera a total of 344 bone marrow biopsies of 216 patients has been collected so far. The number of patients with more than three histological controls under radiophosphorus therapy is now 17. Three patients in the entire group developed granulocytic leukemia and 14 patients suffered myelofibrosis. The first results were published in 1969 (see 1887/III/71-D No. 2), statistical evaluation will not be presented before 1975.
2. In 1973, a study of the role played by megakaryocytes of the bone marrow in polycythemia vera during treatment with radiophosphorus was published together with other results by A. Kronseder in the form of an inaugural dissertation under the title: "The role of the megakaryocytes of the human bone marrow under normal and pathological conditions".
3. The study of histological changes in acute leukaemia before, during, and after therapy now includes 27 patients with 59 control-biopsies. In 11 cases the bone marrow changes have been followed until death. 14 cases with preleukaemic stages are under control. The study is to be continued.
4. The first results of a study of the histological changes of bone marrow and bone under radiation therapy have been published in "Vergleichende histologische Untersuchungen des Knochenmarkes (Beckenkamm) nach lokaler fraktionierter Gamma-Bestrahlung bei 11 Patientinnen mit Genitalkarzinom" by E. Beil, W. Penning, R. Burkhardt (Klin. Wochenschrift) and in "Knochenmarksschäden durch akute und chronische Strahlenwirkungen" by R. Burkhardt (Wissenschaftlicher Dienst Roche "Strahlen, Blutgerinnung und Hämostase"). The most important results are represented in the following table (Fig.2). The control of the late effect is to be continued.

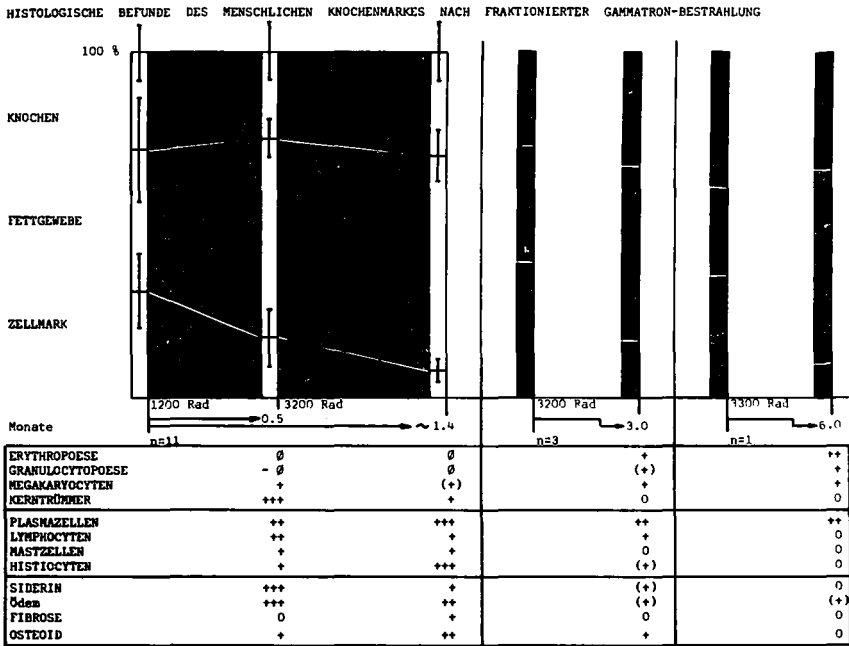

Histologische Befunde des menschlichen Knochenmarks nach fraktionierter Gammatron-Bestrahlung.

Associato della Commissione : Comitato Nazionale per
l'Energia Nucleare (C.N.E.N)

N° del contratto : 108-72-1 B10I

Capo del gruppo di ricerca : G. DORIA.

Tema generale del contratto : Immunogenetics

Immunologic neutralization of viruses or toxins depends on antibody avidity, a function of affinity, which influences the stability of antigen-antibody complexes. The protective value of antibody avidity is most apparent if the immune system is impaired, as a consequence of exposure to radiations or of abnormal recovery following transplantation of allogenic hemopoietic cells.

Antibody avidity at the cellular level. In several immune responses thymus-derived (T) cells have been shown to help bone marrow-derived (B) cells to produce antibodies. Experimental evidence from antibody responses to carrier-hapten conjugates suggests that helper T cells bind the carrier and, by orienting the conjugate, concentrate the hapten on B cells which are thus triggered to produce antibodies to it. Receptors for hapten have been demonstrated on the B cell surface. It is believed that the receptors of each B cell have the same affinity as the antibody secreted upon union between haptens and receptors. Since the affinity of B cell receptors is very heterogeneous, low concentrations of antigen should selectively stimulate high affinity cells whereas high concentrations should generate a population of cells synthesizing

antibodies of low affinity. The latter result may be expected from carrier-hapten stimulation after carrier priming, under the hypothesis that T cells act just as hapten-concentrating device for B cells.

Mice were primed with different doses and for different periods of time with the carrier HRBC. Following stimulation of the primed animals or of their spleen cells in vitro with different doses of the conjugate TNP-HRBC, the immune response against the hapten TNP was estimated from the number of direct PFC per spleen or culture by the Jerne technique with TNP-SRBC. Avidity of antibodies secreted by PFC was evaluated from the amount of added TNP-BSA that inhibited 50% of the PFC anti-TNP.

Both number of PFC and antibody avidity were found greater when mice were primed with HRBC. Under optimal conditions of priming, the carrier effect on PFC number was more evident after higher doses of TNP-HRBC, while the effect on antibody avidity was more pronounced after lower doses of the conjugate. Furthermore, it was found that carrier priming enhances the shift in antibody class from IgM to other classes.

These results are just the reverse of what expected from the hypothesis that antigen concentration is the mechanism that entirely accounts for T and B cell cooperation. It could be envisaged that helper T cells potentiate proliferation of B cells which are being selected by antigen on the basis of receptor affinity. Thus, carrier stimulated T cells could make antigen selection more efficient by expanding the B cell population on which antigen exerts its selective pressure. Moreover, during proliferation B cells may acquire and display a larger variability in receptor affinity from which antigen could select. This view is sup

ported by the observation that the carrier effect on antibody avidity was more pronounced after lower doses of TNP-HRBC.

It cannot be decided whether the enhanced shift in antibody class resulting from carrier priming was responsible for the increase of antibody avidity. However, the concomitant shift from IgM to antibody classes of lower valence points out that the increased avidity mainly resulted from a net rise of antibody affinity.

Antibody affinity in radiation chimeras. Recovery of the immune system after supralethal doses of X-rays can be achieved by transplantation of bone marrow cells. It has been shown in allogenic radiation chimeras that immunization induces antibody production only in donor cells. The antibody response in syngenic chimeras can attain almost normal levels when antigen is injected from 60 days on after bone marrow transplantation. In allogenic chimeras immunized 200-300 days after cell transplantation the response is still subnormal. The lower antibody titer observed in allogenic chimeras has been attributed to incomplete repopulation of the immune system, although it has not been ruled out that immunologically competent cells are less efficient in antibody production when stimulated in allogenic hosts. That an abnormal immune mechanism is operating in allogenic chimeras is suggested by the decreased ability of these animals immunized 120 days after cell transplantation to synthesize 7S antibodies to certain antigens.

The ability of syngenic versus allogenic bone marrow chimeras to produce antibodies with good fit for antigen was investigated in mice immunized 120 days after total body exposure to 900 R and injection of bone marrow cells. Immunization was

carried out by injecting 0.1 mg of DNP-KLH in Freund complete adjuvant subcutaneously to all animals. After 20, 30, or 60 days, groups of 10 animals were injected again subcutaneously with the same dose of antigen in solution. Seven days later the animals of each group were bled and sera pooled. Immunoglobulins were prepared by precipitation of each serum pool with 40% ammonium sulfate and each preparation was reacted against tritium-labelled DNP-lysine according to the equilibrium dialysis technique.

Antibody concentration was found much lower in allogenic than in syngenic chimeras, in which values were subnormal at all immunization times. When the second injection of antigen was given on day 30 or 60, antibody affinity was higher in chimeras than in normal controls, while there was no substantial difference between syngenic and allogenic chimeras. The ability of these animals to produce antibodies of high affinity may well counteract a subnormal number of antibody-forming cells and thus assure their survival.

These results showing higher antibody affinity in radiation chimeras suggest that the irradiated host favours the growth of donor antigen-sensitive cells with receptors of higher affinity. This possibility is under investigation in experiments on the kinetics of the recovery of the immune response in radiation chimeras.

PUBLICATIONS APPEARED IN 1973

DORIA G., AGAROSSO G.

The effect of carrier priming on antibody avidity at the level of single immunocytes. Fed. Proc. 32: 993, 1973.

BARONI C.D., DORIA G.

Hormones and lymphoid tissues. Contact sensitivity and detection of theta-cells in pituitary dwarf mice. In: Microenvironmental Aspects of Immunity, Ed. B.D. Jankovic and K. Isacovic. Plenum Publ. Co. p. 655, 1973.

DORIA G., AGAROSSO G.

Inhibition of the immune response in vitro by rifampicin and derivatives. Scand. J. Resp. Dis. 84: 25, 1973.

MEDGYESI G.A., CSECSI-NAGY M., GORINI G., PUSKAS E., GERGELY J., SAJGO M., CZUPPON A.

Fab-related fragments of human IgG produced by partial tryptic proteolysis. Immunochemistry 10: 509, 1973.

Contractant de la Commission : Université Libre de
Bruxelles

N° du contrat : 093-72-1-BIOB

Chef du groupe de recherche : J.E. DUMONT

Thème général du contrat : Definition of the methodology
for the study of the effects of radiation on human tissues
(blood, cells, etc.) and application of this methodology.

The general aim of the project is the study of physiological and biochemical mechanisms, the alteration of which causes the short and long term effects of radiation and to develop the methodologies necessary to investigate these mechanisms.

The problems studied are the regulation of erythropoiesis, polymorphonuclear phagocytosis and the development of a mathematical model of follicular cell irradiation by radioisotopes of iodine.

- A) Erythropoiesis : irradiation affects erythropoiesis and the catabolism of erythropoietin. It has been demonstrated that :
- 1) The catabolism of erythropoietin is dependent on the integrity of renal parenchyma but is not influenced by uremia per se.
 - 2) The decreased catabolism of erythropoietin in the irradiated animal does not depend on the dose above the level at which bone marrow is completely suppressed.
 - 3) The depression of erythropoiesis in the starved animal is due to a decrease in the size of the population of erythropoietin sensitive blast cells rather than to a decrease of plasmatic erythropoietin.
- B) Polymorphonuclear phagocytosis : irradiation causes both a leukopenia and a decreased bactericidal activity of the leucocytes. As a human model of irradiation a patient with chronic granulomatosis (CGD) has been studied. In both cases a defect of H_2O_2 formation appears to be responsible for the bactericidal defect. Methylene blue which enhances H_2O_2 formation has been tried as drug to correct this defect. Although some metabolic concomitants of phagocytosis reappear in the CGD leukocytes, the bactericidal activity is not reestablished. The validity of currently used indexes of bacterial killing is questioned.
- C) Model of follicular cell irradiation : this program is carried out in another contract.

Résultats du projet n° .1..

Chef du projet et collaborateurs scientifiques :

J.P. NAETS et M. WITTEK

Titre du projet : Effect of irradiation on the metabolism of erythropoietin.

Two effects of irradiation on hematopoiesis are known : a general depression of hematopoiesis and a decrease in the catabolic role of erythropoietin (Proceed. Soc. Exper. Biol. Med., 100, 40, 1959). Two aspects of this problem are studied : the control of erythropoiesis and the metabolism of erythropoietin.

A) Erythropoietin metabolism

We have shown that irradiation increases the half life of erythropoietin, i.e., that it slows down its catabolism. After irradiation with 400r, the half life is increased from 1.5h to 2.3h. This effect could be due to medullary aplasia, i.e., to the disappearance of the target tissue, which would then be involved in the catabolism of its regulatory hormone. This hypothesis could be checked by investigating the half life of erythropoietin in mice irradiated with doses from 200r to 800r. In such mice, aplasia of the medulla is complete already for doses of 200r. In fact, in all cases erythropoietin half life was extended to the same degree, which does not allow to reject our hypothesis. To further check the hypothesis, erythropoietin half life is now compared in animals in which bone marrow aplasia has been induced by Xrays and by the toxic agent mustin.

The role of the kidney in erythropoietin metabolism has been further investigated. We have shown that erythropoietin half life is prolonged (to 10h) in the anephric animal. In animals with ligated ureters, in which urinary elimination is suppressed but kidney parenchyma is presumed to be intact, the half life of erythropoietin is slightly but significantly increased (2h vs 1.5h in controls). This could suggest a slight effect of anuria per se. However, in animals with sectioned ureters, i.e., with anuria but not hydronephrosis or renal damage, the half life of erythropoietin is not increased. Thus the role of kidney parenchyma in erythropoietin catabolism is demonstrated.

B) Control of erythropoiesis

The effect of starvation on erythropoiesis has been further studied. It has been confirmed that contrary to the current concepts, the decrease of erythropoiesis is due to a decrease in the size of the population of erythropoietin sensitive blast cells rather than to a lack of erythropoietin.

Erythropoiesis, although much reduced, persists in the anephric man. It is also reduced, but to a lesser extent, in patients with complete renal failure undergoing dialysis, i.e., in patients with little parenchyma left.

Erythropoietin is not detectable by presently available techniques in both diseases. Such patients require 336ml/month vs 134ml/month in the anephric patients. This could suggest either a shortened red cell life in the anephric

or some effect of renal parenchyma in the uremic patients. 30 anephric patients and 37 chronically dialyzed patients have been studied. The lifespan of the red cells (labeled with ^{51}Cr), red cell mass and splenic sequestration of the red cells has been measured. It has been shown that the red cell lifespan is equally shortened and the sequestration equally increased in both types of patients. Thus erythropoiesis itself is less reduced in uremic patients, which suggests that the renal parenchyma left in these patients still secretes some erythropoietin.

BIBLIOGRAPHY

NAETS, J.P., WITTEK, M.

The role of the kidney in the catabolism of erythropoietin in the rat.
J. Lab. Clin. Med., in press.

NAETS, J.P., WITTEK, M.

Effect of starvation on the response to erythropoietin in the rat.
Submitted to Acta Haematologica.

NAETS, J.P., LAURENT, Cl., WITTEK, M., VEREERSTRAETEN, P., TOUSSAINT, Ch.

Red cells lifespan, splenic sequestration and transfusion requirements in chronic renal failure treated by hemodialysis. Effect of bilateral nephrectomy.
Clinical Nephrology, in press.

NAETS, J.P.

Hematologic disorders in renal failure.
Nephron, in press.

Résultats du projet n° .2..

Chef du projet et collaborateurs scientifiques :

E. SCHELL-FREDERICK, J. VAN SANDE, J.E. DUMONT

Titre du projet : Polymorphonuclear phagocytosis.

Leucocyte function as well as number is critical for the defense of the organism against infection. Irradiation produces an early decrease in phagocyte function and later also a well-documented leucopenia. Our work has been concerned with the mechanisms of uptake and killing of bacteria in normal, diseased and irradiated animal and human polymorphonuclear leucocytes (PMN).

A) Chronic granulomatous disease (CGD) as a model for irradiation damage to Leucocytes

We have noted a striking parallelism between the biochemical lesions of the PMN of irradiated animals and of a child affected with chronic granulomatous disease (see Euratom Research Report, 1972, 358 for a description of this disorder) who has been under study in our laboratory. A variety of arguments supports the hypothesis that the primary metabolic defect in the two instances is a failure to increase hydrogen peroxide (H_2O_2) during phagocytosis. Other workers have shown that the introduction of an H_2O_2 generating system into CGD leucocytes corrects the biochemical defects and improves the bactericidal capacity of these leucocytes. We have now completed our work on the effect of methylene blue (MB) on normal and CGD leucocyte function. We have postulated that MB might improve the bactericidal capacity of CGD leucocytes by producing H_2O_2 within the cell. The myeloperoxidase enzyme system, requiring H_2O_2 and a halide cofactor such as iodide for its activity, appears to be important in bacterial killing. We have used iodination as a measure of this enzyme system (New Engl. J. Med., 284, 744, 1971).

Our results show that :

- 1) MB $100\mu M$ does generate H_2O_2 in leucocytes as measured by an increase in oxygen consumption which is cyanide insensitive.
- 2) MB is concentrated 50-100 fold in normal leucocytes.
- 3) MB stimulation of the hexose monophosphate shunt persists for at least 4 hours following removal of MB from the medium.
- 4) MB, added simultaneously with phagocytic particles, restores the iodination ability of CGD leucocytes to approximately 60% of stimulated control values but inhibits slightly the stimulated value in control PMN. When the phagocytic particles are added after MB has penetrated the cell, the corrective effect is reduced by 50%.
- 5) MB does not increase the bactericidal capacity of CGD leucocytes. It should be noted that in these experiments bacteria were added after MB entry into the leucocyte.
- 6) MB does not appear to inhibit the rate of phagocytic uptake. The validity of using protein iodination and hexose monophosphate shunt activity as index of bacterial killing is therefore questionable.

The failure to improve the bactericidal capacity of CGD leucocytes in vitro with MB even in the face of increased myeloperoxidase activity probably reflects an insufficient concentration of MB and therefore generated H_2O_2 in the phagolysosome. Thus MB is not a useful therapeutic agent in CGD. It is nevertheless worthwhile to evaluate the effect of MB on PMN function in irradiated animals where the extent of the biochemical lesion may be different and where one can predict the time of greatest susceptibility to infection, thus possibly allowing MB administration at the same time as bacterial invasion and thereby heightening MB effectiveness (see 4). These results will shortly be submitted for publication in the British Journal of Haematology.

BIBLIOGRAPHY

- SHELL-FREDERICK, E., VAN SANDE, J.
Evidence that cyclic AMP is not the chemical mediator of the metabolic changes accompanying phagocytosis.
Res. J. Retic. Soc., in press.

LANGZEITWIRKUNGEN UND TOXIKOLOGIE DER RADIOAKTIVEN ELEMENTE

LONG-TERM EFFECTS AND TOXICOLOGY OF RADIOACTIVE ELEMENTS

EFFETS A LONG TERME ET TOXICOLOGIE DES ELEMENTS RADIOACTIFS

Weitere Forschungsarbeiten zu diesem Thema werden auch in folgenden Jahresberichten beschrieben:

Further research work on these subjects will also be described in the following annual reports:

D'autres travaux sur ce thème de recherche sont également décrits dans les rapports annuels suivants:

096-BIOB Univ. Louvain (Goffeau)

Biology Group Ispra

Contractant de la Commission :

CENTRE D'ETUDE DE L'ENERGIE NUCLEAIRE - MOL.

N° du contrat : 095-72-1-BIOB

Chef des groupes de recherche : Jean R. MAISIN

Thème général du contrat : PROGRAMME DE RECHERCHES AYANT POUR
OBJET LES EFFETS A COURT ET A LONG TERME DES RAYONNEMENTS.

The research performed on this contract have been devoted to the following problems :

SHORT TERM EFFECTS

1. The development of biochemical indicators of radiation damage.
2. Effects of X-irradiation and radiomimetic substances on the synthesis of ribosomal and messenger RNA's and on the structure and formation of polyribosomes.

LONG TERM EFFECTS

1. Influence of chemical radioprotectors on the long term effects of ionizing radiation.
2. Studies on biochemical parameters in different organs.

GENETIC EFFECTS

1. Study of the chromosome rearrangements induced in male mice by ionizing radiations.
2. Study of the chromosome rearrangements induced in female germ cells by ionizing radiations.
3. Study of radioinduced chromosome aberrations by banding pattern techniques.

Results of project N° 1

Head of the project : G. GERBER

Title of the project : **BIOCHEMICAL INDICATORS OF
RADIATION DAMAGE**

The development of biochemical indicators of radiation damage depends on information obtained from man or primates. Such studies have been hampered by the scarceness of the material as well as by the lack of simple and rapid methods. We have selected about 30 tests in urine thought to be useful in this respect and have adapted existing methods or developed new ones in such a manner that all determinations can be carried out by 1-2 technicians within 2-4 days. The lab manual which is now written contains the following determinations :

Ions : Na, K, NH_4

Enzymes : Amylase, β -glucuronidase, RNase, proteolytic act.

Amino acids : Total amino acids, creatine, creatinine, taurine, delta-amino levulinic acid, β -amino isobutyric acid, hydroxyproline, hippuric acid, kynurenic acid, xanthurenic acid, neuraminic acid.

Nuclides : Uric acid, pseudouridine, deoxycytidine.

Biogenic amines : serotonin, 5OH indolacetate, histamin, dopamin, noradrenalin.

Some of the methods are still investigated in more detail.

These techniques were utilized in urine of irradiated primates (obtained by the courtesy of Prof. van Bekkum) as well in that of rats exposed to graded doses of X-rays. Taurine, creatine and in rats deoxycytidine appear so far still to be the indicators of the greatest potential interest.

The mechanism of excess excretion of pseudouridine after irradiation was studied in mice and rats. Labeled orotic acid was injected either 1 day before or shortly after irradiation, and the different metabolites of RNA in urine were isolated. Simultaneously the changes in radioactive pseudouridine, uridine and cytidine are followed in RNA isolated from different organs. These experiments will be completed in 1974.

The studies dealing with biochemical parameters in brain and with the uptake of amino acids by different organs of mice in dependence of age, strain and neonatal irradiation were continued. Marked alterations in lysosomal enzymes neurotransmitters and sialic acid with age were observed. Differences in lysosomal enzymes and neurotransmitters exist also with respect to the strain of the animals. Irradiation causes a temporary increase in lysosomal enzymes and in sialic acid and changes in neurotransmitters.

G.B. GERBER

Biochemical Indicators of Radiation Damage : Perspective and Review
Journal Belge de Radiologie, 1972, 55 , 4, 493-501

G.B. GERBER, M.B. YATVIN

The influence of age and other factors on the uptake of α -aminoisobutyrate by different organs : Physiology, 1973, 32 , 732-737

J. GITS, G.B. GERBER

Electrolyte loss, the main cause of death from the Gastro-intestinal syndrome, Radiat. Res., 1973, 55 , 18

G.B. GERBER

Brain biochemistry and substrate uptake after irradiation of new-born mice and the changes with age : European Society for Radiation Biology Tenth Annual Meeting, October 12th - 13th , 1973 Madrid, Spain, Abstract Book p. 14

D. KOZMIERSKA-GRODZKA, G.B. GERBER, J.P. DECOCK,

Sialic acid and neuraminidase after whole body irradiation of rats,
(in press)

Résultats du projet n° 2

Chef du projet et collaborateurs scientifiques :

R. GOUTIER, W. BAEYENS

Titre du projet : EFFECTS OF X-IRRADIATION AND RADIOMIMETIC
SUBSTANCES ON THE SYNTHESIS OF RIBOSOMAL AND MESSENGER RNA'S
AND ON THE STRUCTURE AND FORMATION OF POLYRIBOSOMES

The analyses which have been performed during the past years on livers of normal rats have been repeated using the livers of partially hepatectomized rats.

Contrary to our observations with resting livers, we did not obtain any stimulatory action of whole-body X-irradiation at different intervals after partial hepatectomy. Even after very short periods, the synthesis of ribosomal or messenger RNA was never stimulated but rather depressed by irradiation. The reason for this difference in radiation response between a tissue, actively synthesising DNA, and a tissue where most nuclear material is only involved in metabolic activities is not clear and demands further research.

Recent results in other laboratories indicated the complex composition of certain cytoplasmic components, considered to be precursors of polyribosomal structures. For that reason we started a reinvestigation of the composition of polyribosomal precursors after formaldehyde-fixation and separation on preparative CsCl gradients. The aim is to detect poly-(A) stretches, considered to be typically for m-RNA. Until now we failed to extract the RNA of fixed ribonucleoprotein particles in a sufficiently undegraded form. We are currently investigating the possibility to use metrizamide-gradients which permit the omission of the formaldehyde-fixation step.

Since hormonal mechanisms are involved in the radiation-induced alterations observed on polyribosomes, we continued our collaboration with Dr M. Lemaire from the Department of Radiotherapy, University of Liège. We examined in more detail the influence of glycogen and the use of α -amylase upon the results

obtained after the combined administration of X-irradiation, thyroid hormones and adrenocorticotrophic hormone.

In collaboration with Prof. E. Frédéricq of the University of Liège, we examined the RNA polymerase-activity of certain chromosomal proteins, the nuclear acidic proteins. The results, although preliminary and depending on the different preparations used are encouraging. RNA polymerases being relatively unstable in general, modifications in preparative methodology must be further analyzed in order to evaluate the part played by the nuclear acidic proteins and by the RNA polymerase in the effects of irradiation at the level of the nuclear precursors of polyribosomes.

W. BAEYENS, R. GOUTIER and V. VANGHEEL

Radiation-induced alterations in the synthesis of ribosomal and informational particles in rat liver.
Strahlentherapie, in press.

W. BAEYENS and R. GOUTIER

Effect of total body irradiation on the synthesis of the polyribosomal RNAs in rat liver.
Tenth Annual Meeting of the European Society for Radiation Biology,
October 12th-13th, 1973, Madrid, Spain. Abstract Book p. 5

Résultats du projet n° 3

Chef de projet et collaborateurs scientifiques :

J.R. MAISIN, G. MATTELIN, M. LAMBIET-COLLIER, C. BIESEMANS-VANGENECHTEN

Titre du projet : INFLUENCE DES RADIOPROTECTEURS CHIMIQUES SUR LES EFFETS A LONG TERME DES RADIATIONS IONISANTES

Des souris mâles de race BALB/c et C57B1 âgées de 4 et 12 semaines sont irradiées sur tout le corps ou sur le thorax par une ou plusieurs doses de rayons X. La moitié des souris sont protégées par la 2- β -aminoéthylisothio-uronium-Br-HBr (AET), la 5-hydroxytryptamine (5-HT) ou une association d'AET de glutathion (GSH), de 5-hydroxytryptamine, de cystéine et de mercaptoéthylamine (MEA).

I. SURVIE (irradiation totale)

Souris BALB/c

Les survies médianes des souris irradiées sur l'ensemble du corps par de faibles doses de radiations (100-175 R) montrent que l'association de substances radioprotectrices utilisées protègent les souris irradiées (Fig. 1). La protection offerte est cependant inférieure à celle obtenue après une dose de 500 R (facteur de réduction de dose \approx 2). La meilleure survie des souris protégées et irradiées par de faibles doses de rayons X semble due surtout à une diminution chez les souris protégées du taux de leucémies myéloïdes (11% chez les souris irradiées sans protection contre 2% chez les souris protégées).

L'importance des autres causes de mort est à peu près identique.

Souris C57B1

Le facteur de réduction de dose optimum obtenu pour la longévité des souris C57B1 irradiées sur l'ensemble du corps par une dose unique de radiations est égale ou supérieure à celui obtenu pour les souris BALB/c et varie comme pour les souris BALB/c avec la dose de radiations administrée (Fig.1).

Ces résultats sont intéressants car les principales causes de mort pour les souris témoins de ces deux races ne sont pas les mêmes. Les souris C57B1 présentent une grande incidence d'affections hépatiques (adénome, angiome et cirrhose) alors que les souris BALB/c souffrent d'un haut pourcentage de cancer pulmonaire.

II. SURVIE (irradiation de la cage thoracique)

Chez les deux races de souris la protection offerte par les associations de substances radioprotectrices contre les affections pulmonaires (radio-pneumonie et cancers pulmonaires) est faible. Ceci confirme les résultats antérieurs que nous avons obtenus pour les souris BALB/c protégées par une association de substances radioprotectrices et irradiées sur l'ensemble du corps avec des doses de 1000 R ou plus, dont un grand nombre de souris mouraient de radiopneumonie.

III. PATHOGENESE DE LA LEUCEMIE THYMIQUE

Des souris AKR (mâles normales) traitées par une association de substances radioprotectrices de la quatrième semaine après la naissance à raison d'une injection jusqu'à la mort, présentent un taux de leucémies lymphoïdes inférieur à celui obtenu chez les témoins normaux. Les souris traitées souffrent d'une leucémie lymphoïde d'origine splénique et non thymique. Des expériences sont en cours pour comprendre le pourquoi de cette observation. S'agit-il d'une action sur les virus oncogènes ; sur les cellules cibles ou sur l'un ou l'autre de ces deux facteurs ?

Summary and Conclusions

BALB/c and C57B1 male mice were irradiated on whole the body or on the thorax. Half of the mice were protected by an association of AET, 5-HT, glutathion, cystein and mercaptoethylamine.

1. The median survival time for the BALB/c and the C57B1 protected mice irradiated on the whole body with low doses of X-rays is higher than for the non protected irradiated mice (Fig. 1).
2. For low doses of irradiation (100-175 R), the difference in the median survival time is due mainly to a lower incidence of myeloid leukemia (2%) in the protected mice compared to the non protected mice (11%).

3. The optimum dose reduction factor for the protected C57B1 mice irradiated on whole the body is the same than for the BALB/c mice. These results are of interest since the mean causes of death of the control mice of these two strains are different.
4. The protection offered by chemical radioprotectors against radiopneumonia and lung cancer is low.
5. Non irradiated AKR mice treated with an association of chemical radioprotectors once a week from the fourth week of life, present a lower incidence of lymphoid leukemia than control mice. In the majority of the treated mice leukemia originates in the spleen or in the lymph nodes and not in the thymus.

J.R. MAISIN

Late effects of radiation and chemical protectors.
 XIth Scientific Meeting of the Society for Laboratory Animal Science,
 Antwerp, May 9th-12th, 1973. Abstracts p. 21

J.R. MAISIN, G. MATTELIN and M. LAMBIET-COLLIER

Long term survival and causes of death in chemical protected and non-protected irradiated mice.
 à présenter au "5th Internat. Congress of Radiation Research", Seattle
 (Wash., U.S.A.), July 14-20, 1974.

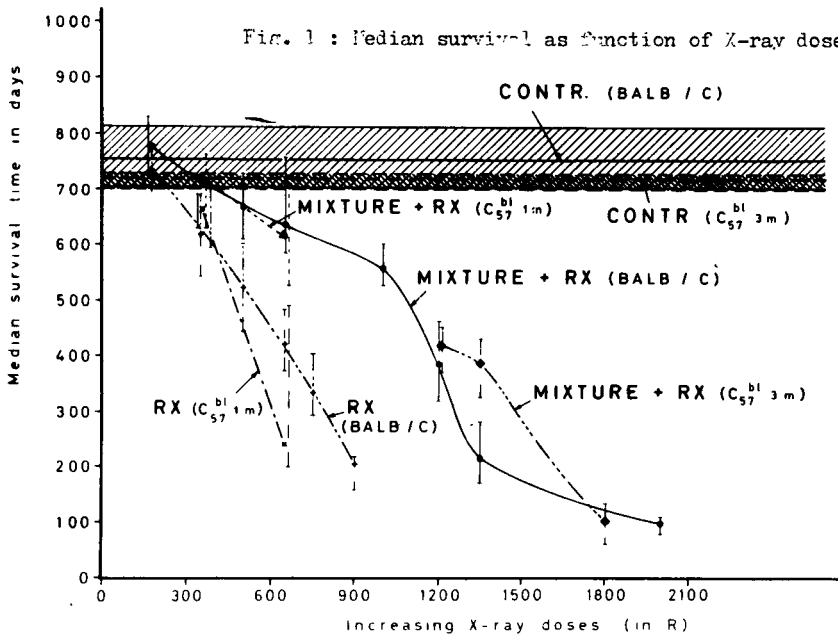

Résultats du projet n° 4

Chef du projet et collaborateurs scientifiques :

A. LEONARD, B. IVANOV, Gh. DEKNUDT

Titre du projet : STUDY OF THE CHROMOSOME REARRANGEMENTS INDUCED
IN MALE MICE BY IONIZING RADIATIONS.

Using the specific locus method Selby (from Oak Ridge) has shown recently that the mutation frequency in newborn male mice after an acute X-ray exposure to 300 R was statistically significantly lower than that in adults. Male mice irradiation at 2,4,6,8,10,14,21,28 and 35 days of age displayed for the earlier stages tested, a mutation rate representing a transition between newborns and adults. The present experiments were designed to detect whether similar age effect exists also with respect to the rate of chromosome rearrangements, such as reciprocal translocations, induced in premeiotic male germ cells by an exposure to X-rays.

Male C57B1 mice were whole body exposed to 0, 100, 200 or 300 R of X-rays immediately after birth or when 90 or 450 days old. The conditions of X-irradiation were 270 kV, 20 mA, filtration 1 mm Ca, dose rate 100 R/min. One hundred days after exposure the male mice were killed, and meiotic preparations made from the testes by the air-drying technique of Evans et al. From each animal, 100 to 400 spermatocytes in the diakinesis first metaphase stage of meiosis were examined for the presence of chromosome rearrangements induced in premeiotic germ cells. Two thousand dividing spermatocytes from ten 550 days old control males were examined using the same technique.

No cell with chromosome rearrangements was detected in the control mice ; all cells showing 20 bivalents (2OII) (Table I). The chromosome anomalies identified in the irradiated animals were reciprocal translocations in the form of rings (R) or of chains (C). Both types were found in each irradiated animal and no significant difference was seen between the three irradiated groups of different ages with respect to the number of abnormal cells and the complexity of chromosome rearrangements.

TABLE I
Results of the spermatocyte examination

Observations	Treatment											
	Control			Newborns			90 days old mice			450 days old mice		
	100 R	200 R	300 R	100 R	200 R	300 R	100 R	200 R	300 R	100 R	200 R	300 R
Animals examined	5	10	10	10	10	10	10	10	10	9	9	9
Total cells analyzed	2,000	2,000	2,000	2,000	2,000	1,900	1,900	1,900	1,900	1,800	1,800	1,800
Abnormal cells	0	51	82	115	52	89	118	57	81	97	81	97
Total %	0	2.55 [±] 0.33	4.10 [±] 0.39	5.75 [±] 0.42	2.60 [±] 0.42	4.45 [±] 0.26	5.90 [±] 0.21	2.90 [±] 0.45	4.50 [±] 0.65	5.39 [±] 0.62	4.50 [±] 0.45	5.39 [±] 0.62
Type of abnormal cells												
One translocation												
18II + RIV	27	53	76	37	68	81	31	46	59	31	46	59
18II + CIV	24	29	39	14	21	37	25	35	33	25	35	33
Two translocations												
17II + RVI	-	-	-	-	-	-	1	-	1	-	-	1
17II + CVI	-	-	-	-	-	-	-	-	-	-	-	1
16II + RIVIV	-	-	-	-	-	-	-	-	-	-	-	3

The rates of abnormal cells observed in the three groups after 100, 200 or 300 R are in very good agreement with the results of previous experiments. In newborn mice, all germ cells in the testes are gonocytes whereas the cells examined as dividing spermatocytes 100 days after exposure of 90 days and 450 days old animals had been at the spermatogonial stage at the time of irradiation. Our results show that there is no difference between gonocytes and spermatogonia with respect to the number of abnormal cells resulting from exposure to ionizing radiations. Dose-effect curves for genetic damage induced in premeiotic male germ cells can be modified after irradiation by selection and/or repair. One might expect the chromosomal abnormalities to be eliminated by selection more readily than are cells carrying only specific locus mutations. Such processes might, therefore, mask some differences existing between the newborn and adult mice with respect to the induction of reciprocal translocations in premeiotic male germ cells and explain the discrepancy between our results and those of Selby using the specific locus method.

B. IVANOV, A. LEONARD and Gh. DEKNUDT

Chromosome rearrangements induced in the mouse by embryonic X-irradiation. Mutation Research : 18, 89-92, 1973.

B. IVANOV and A. LEONARD

Radiosensitivity, to translocation induction, of premeiotic male germ cells of mice of different ages. Mutation Research (in the press).

A. LEONARD

Importance of genetic factors in late effect studies. EULEP Newsletter (in the press).

A. LEONARD

Etude, chez la souris, des anomalies chromosomiques spontanées ou induites artificiellement par les radiations ionisantes et les mutagènes chimiques. Dissertation Agrégation Enseignement Supérieur, Louvain 145 p., 1973.

A. LEONARD

Effects of low level doses of radiation on male mammalian germ cells. XIII Int. Congress of Radiology. Abstract. (1973).

A. LEONARD

Effects of low level doses of radiation on male mammalian germ cells. Excerpta Medica (In the press).

A. LEONARD, Gh. DEKNUDT and B. IVANOV

Influence d'une irradiation prénatale sur la fertilité des souris mâles et femelles. C.R. Société Biol. (in the press).

Résultats du projet n° 5

Chef du projet et collaborateurs scientifiques :

A. LEONARD, N. GILLIAVOD

Titre du projet : STUDY OF THE CHROMOSOME REARRANGEMENTS INDUCED
IN FEMALE GERM CELLS BY IONIZING RADIATIONS.

Previous experiments performed by analyzing genetically or both genetically and cytologically the F1 male offspring from irradiated female mice have shown that translocations can be recovered only rarely from irradiated female mice. Since some selective alimentation could occur between exposure and fertilisation, this problem has been studied here by the observation of meiotic chromosomes from irradiated females at short intervals of time after X-ray exposure.

BALB/c mice were used in this experiment. The females were killed after a dose of 0, 25, 50, 100 or 200 R of X-irradiation and their meiotic chromosomes prepared by a method adapted by E.P. Evans (unpublished) from the techniques of Edwards (1962) and Tarkowski (1966). The results are summarized in the table hereafter.

Cytological observation of the oocytes

Treatment	Oocytes examined	Oocytes abnormal	Nature of aberrations
0	101	-	
25	42	2	RIV ; RIV
50	108	4	RIV ; RIV ; RIV ; CIV
100	80	6	2RIV ; fragment ; frag ; frag ; frag ; 2 frag.
200	85	-	

The most frequent aberrations were the quadrivalents in the form of ring. Some oocytes given 100 R were found with fragments. These results demonstrate that ionizing radiation can induce some chromosome rearrangements in oocytes and that the absence of translocated offspring from irradiated females is probably the result of germinal selection. From these results it is however impossible to determine the nature of the relation between the dose and the rate of oocytes with chromosome rearrangements. In view of the fact that the LD100 values are 2000 R of X-irradiation for the mouse follicles which were studied here, one can reasonably infer that the conclusions of this study can be extended to man. In this species indeed, the LD50 of the primordial follicles is 2000 R and more than 5000 R for the growing and Graafian oocytes.

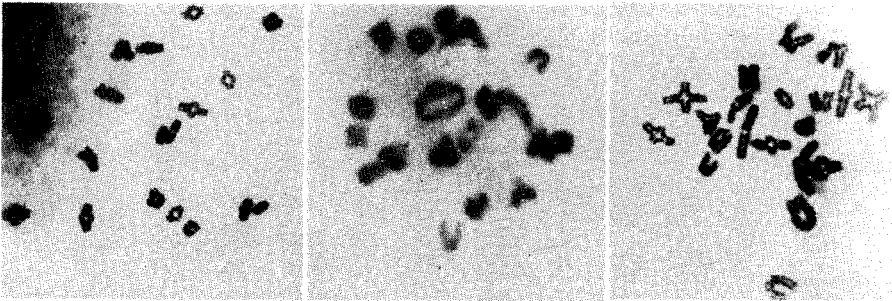

Fig. 1

Fig. 2

Fig. 3

Figure 1 : Dividing oocytes with 20 bivalents.

Figure 2 : Dividing oocyte with 18 bivalents and a ring quadrivalent.

Figure 3 : Dividing oocyte with 18 bivalents and a chain quadrivalent.

N. GILLIAVOD and A. LEONARD

Sensitivity of the mouse oocytes to the induction of translocations by ionizing radiations.

Can. J. Genet. Cytol. : 15, 363-366, 1973.

N. GILLIAVOD and A. LEONARD

Sensitivity of the mouse oocytes to the induction of translocations by ionizing radiations.

Xth Meeting of the E.S.R.B., Madrid, Abstract.

Résultats du projet n° 6

Chef du projet et collaborateurs scientifiques :

A. LEONARD, Gh. DEKNUDT, G. DECAT

Titre du projet : STUDY OF RADIOINDUCED CHROMOSOME ABERRATIONS
BY BANDING PATTERN TECHNIQUES.

This study was planned to establish a relation between the aspect of chromosome rearrangements in mitotic and meiotic germ cells using the Giemsa staining techniques. This year has been devoted to solve the technical problems of the preparation from *in vivo* tissues metaphases showing analysable chromosomes. A quite satisfactory method has been finally found and we are actually able to get from each animal numerous metaphases with excellent "banded" chromosomes. The technique is actually used to study several translocated animals which have been produced by irradiation of male germ cells. The first results are expected for the beginning of 1974.

Summary of the technique

1. Animals to be analysed receive an intraperitoneal injection of colchicine (10 cc/1000 gr) at a concentration of 0.025% one hour before sacrifice.
2. KCl solution (0.075 M) during 10' is used for the hypotonic treatment of bone marrow and testes.
3. The cells are fixed in methanol-acetic acid (3/1)
4. After storage of at least 24 hours, the preparations are treated with a trypsin solution (0.025%) at a concentration of 1000 units/gramme. According to the nature and origin of the tissue the treatment is made during 5" to 30".
5. The preparations are then stained by a modified Giemsa technique during 2 to 5 minutes in 1 part Giemsa/20 parts Borax Buffer at a pH 9.

Vertrag Nr. 090-72-1 BIAD

Institut für Biologie der Gesellschaft für Strahlen- und
Umweltforschung mbH, Neuherberg/München - Germany

O. Hug, W. Gössner, A. Gerspach, I. Günzel, U. Hägele, A. Luz,
K.-H. Marquart, W.A. Müller, J. Murken, F. Schales, H. Spiess,
W. Wiederholt, W.A. Winter

Pathogenesis of radiation damage

Radiotoxicity

After incorporation of bone-seeking radionuclides in rodents the nature and development of early and late effects, especially the production of bone tumors is studied. The dependency upon the mean skeletal dose and the role of dose distribution in time and space are investigated by using various radionuclides differing by radiation emitted, their half-lives and their mode of deposition.

The distribution of ^{90}Y and ^{88}Y was studied especially with regard to the influence of the stable carrier.

Electron microscopic studies of ^{224}Ra and ^{227}Th -induced osteosarcomas revealed type A viral particles.

(C3H x 101) F_1 -hybrid mice show the same osteosarcoma risk after incorporation of ^{224}Ra as NMRI mice.

Dose protraction experiments with repeated injections of ^{224}Ra have been extended to a protraction time of 9 months and to a total mean skeletal dose of about 2 000 rads.

Morphology of early effects of internal irradiation with ^{224}Ra in fracture callus can give some explanation for in earlier experiments observed low osteosarcoma risk of irradiated callus.

Experimental studies of the radiosensitivity of the induced cell cycle in the salivary glands and the kidney have been performed as the basis for future long term experiments.

Epidemiological studies are concerned with the late effects of ^{224}Ra after therapeutic application in juveniles and in patients with ankylosing spondylitis.

Project 1

Late effects after incorporation of bone-seeking radionuclides

W. Gössner, I. Günzel, O. Hug, A. Luz, K. -H. Marquart, W.A. Müller

I. Metabolic and dosimetric studies with short-lived α - and β -emitting bone-seekers

Distribution studies were performed with single and protracted doses of ^{90}Y . The investigations were divided in carrier-free studies and in those with different additional amounts of carrier, the chemical form was citrate. The retention showed high values ($> 80\%$) in the skeleton in carrier-free studies and high spleen and liver contents after high carrier application.

An intercomparison experiment with 3 bone-seekers (^{223}Ra , ^{239}Pu , ^{90}Sr) is now running with participation of 6 EULEP-institutes.*

II. Tumor induction

The long term experiment with $(\text{C3H} \times 101)\text{F}_1$ -hybride mice (females: 50 control animals, 100 experimental animals, males: the same numbers) after incorporation of $25 \mu\text{Ci } ^{224}\text{Ra}/\text{kg}$ has shown the following results (see table 1):

In male control animals none osteosarcoma, 4 % ossifying fibromas of the jaws.

In male experimental animals 11 % non head osteosarcomas, 3 % osteomas of the skull, 8 % ossifying fibromas.

In female control animals 4 % non head osteosarcomas.

In female experimental animals 13 % non head osteosarcomas, 2 % osteomas of the skull and 2 % ossifying fibromas.

Since within 1 year about 50 % of the female mice had to be killed with mammary tumors one can conclude that the non head osteosarcoma risk of the females is at least twice higher than that of the males, i. e.

* EBONY project of EULEP, coordinator W.A. Müller, see EULEP report

about the same sex ratio (1:1.5) as in the experiments with the NMRI strain. The experiment shows that there exists no significant difference between the two strains of mice with regard to the induction of bone tumors.

Further protraction experiments with ^{224}Ra have been started with female NMRI mice, 4 weeks of age (see table 2).

In addition an experiment comparing the effect of ^{227}Th and its daughter product ^{223}Ra has been started (see table 3).

Electron microscopic investigation of 7 osteosarcomas from NMRI mice, induced by the incorporation of ^{224}Ra , revealed the presence of peculiar intracellular particles in all of the tumors examined. The particles were spherical, measured about 80 nm in diameter and consisted of two electron-dense, ring-shaped, membrane-like shells which concentrically surrounded an electron-lucent core. Nearly all of the particles with this doughnut-like ultrastructural appearance occurred in cisternae of the rough-surfaced endoplasmic reticulum (RER) of tumor cells (Fig. 1). Crescent-shaped particles were occasionally found presumably in the stage of formation by budding into cisternae of the RER from its membrane component.

The ultrastructure, size and formation of the particles, as well as their location in relation to intracellular structures, are similar to those described for intracisternal type A viral particles.

Table 1 Bone tumors after ^{224}Ra incorporation
in (C3H x 101) F_1 -hybride mice

Treatment	Males		Females	
	none	25 $\mu\text{Ci}/\text{kg}$	none	25 $\mu\text{Ci}/\text{kg}$
No. of mice examined	50	100	50	100
osteosarcoma (without head)	0	11	2	13
osteosarcoma (head)	0	3	0	3
osteoma (head)	0	3	0	0
ossifying fibroma (jaw)	2	5	0	1



Fig. 1 A virus-like particle is located in a cisterna of the RER of a cell from a ^{224}Ra -induced murine osteosarcoma. X 30,000.

Table 2 Experiments with repeated injection of ^{224}Ra
(dose protraction), started 1973

Female NMRI mice 4 weeks of age

Injection per week	none	2 x 0,5 $\mu\text{Ci}/\text{kg}$	2 x 1,5 $\mu\text{Ci}/\text{kg}$
Duration of injection period	--	36 wk	24 wk
Total activity	--	36 $\mu\text{Ci}/\text{kg}$	72 $\mu\text{Ci}/\text{kg}$
Total mean skeletal dose	--	1 100 rads	2 200 rads
No. of animals	95	100	50

Table 3 Experiments comparing the effect of ^{227}Th and
its daughter product ^{223}Ra , started 1973

Female NMRI mice 4 weeks of age

$^{227}\text{Th}/\mu\text{Ci}/\text{kg}$	none	5	-	10	-
$^{223}\text{Ra}/\mu\text{Ci}/\text{kg}$	none	-	14.5	-	29
Total mean skeletal dose	--	1 100 rads	1 100 rads	1 200 rads	1 200 rads
No. of animals	100	100	100	100	100

Project 2

Histogenesis, classification and nomenclature of radiation-induced tumors.

W. Gössner, A. Luz

In April 7 - 8 and December 1 - 2, 1973 two work-shops of the EULEP-committee on pathology standardization have been organized.

The main topic of these work-shops were the "Tumors of the hemopoietic tissue in mice".

The second meeting was attended by invited speakers (Dr. H. L. Stewart, Registry of Experimental Cancers, National Cancer Institute, Bethesda / U.S.A.) and Dr. L. Chieco-Bianchi (Department of Experimental Oncology, Institute of Pathological Anatomy and Pathological Histology, University of Padova / Italy).

For further details see EULEP-report.

Project 3

Pathogenesis of early and late effects after internal and external irradiation

I. Radiochemical and morphological studies on fracture callus

I. Günzel, W.A. Müller

The turnover of ^{47}Ca and ^{224}Ra was studied in callus of both tibiae and bone samples of knees, femora, vertebral column and skull by γ -spectrometric measuring methods. These measurements have been correlated with histological and α -autoradiographic studies. Both radionuclides showed a sharp increase of retention in the fracture callus 5 to 10 days after fracturing. This effect was much greater for ^{47}Ca than for ^{224}Ra .

The histology of the fracture callus has been studied after incorporation of $25\ \mu\text{Ci } ^{224}\text{Ra/kg}$ at the 9th day after fracture of both tibiae.

The damage to the osteogenic tissue was not severe and even less than in the metaphysis of the tibia.

Therefore the already observed low bone tumor risk in a corresponding long term experiment can not be explained by an increased cell loss.

II. Autoradiographic distribution studies

W. Gössner, I. Günzel, A. Luz

Autoradiographic distribution studies of ^{224}Ra and ^{227}Th in soft tissues have been extended. In contrast to ^{224}Ra , ^{227}Th shows more often local concentration in the interstitial connective tissue of the organs. With increasing age of the animals "hot spots" within the connective tissue of the medulla of kidney have been observed. ^{227}Th seems to have an affinity to degenerative lesions in the connective tissue.

III. Radiation sensitivity of stimulated cell cycle

A. Salivary glands in mice

W. A. Winter

The role of parasympathic influence for isoproterenol-induced DNA synthesis was studied by injection of pilocarpin and atropin. These experiments have shown that both, stimulation and inhibition of parasympathic influence reduce the isoproterenol-induced DNA synthesis.

The significance of the functional status for radiosensitivity of salivary glands has been studied by pretreatment with pilocarpin and atropin. In untreated animals acute radiation damage is higher in the parotid gland than in the submandibular gland.

After treatment with pilocarpin the radiosensitivity has changed i. e. the submandibular gland shows more damage than the parotid gland.

B. Prostate gland

W. A. Winter

Additional experiments have shown that by isoproterenol injection DNA synthesis can also be induced in the dorsal part of the prostate gland of mice.

C. Studies of rat kidney

U. Hägele

The highest values of the ^3H -thymidine-labelling-index (14 %) have been observed after injection of lead (II) acetate in combination with temporal ischaemia. (Lead injection combined with nephrectomy or nephrectomy alone shows a ^3H -thymidine-labelling-index of 4.7 % and 2.0 % respectively.)

Whole body irradiation with 800 rad in G_1 -phase immediately and 18 hours after treatment results in a reduced ^3H -labelling-index, which however is still of the same order of magnitude as after nephrectomy alone. There seems to be a threshold dose between 200 and 400 rads. Irradiation with 800 rads results in a complete inhibition of DNA synthesis induced by nephrectomy or nephrectomy in combination with lead.

Project 4

Studies on late effects induced by ^{224}Ra in children and adults

H. Spiess, A. Gerspach, J. Murken, W. Wiederholt

The results are summarized in table 1.

In the meantime a reinvestigation of all available X-ray pictures of treated patients has been carried out. This study has shown 13 additional cases with exostosis after ^{224}Ra treatment as juveniles (11 multiple, 2 single localization) (see table 2). The total number amounts now to 30 patients.

A reinvestigation of the case histories with respect to lesions of the liver and kidney and to soft tissue tumors has been started by Dr. Mays and Dr. Gerspach.

Table 1 Reinvestigation of ^{224}Ra treated patients
June 1973

Total number: 1813

not found: 241, physicians report without name: 654, investigation refused: 16,
exactly controlled: 902

<u>Age at beginning of ^{224}Ra treatment</u>	<u>1 - 20 years</u>	<u>after 21 years</u>	<u>total number</u>
reply received	218	684	902
report by physician or questionnaire	39	326	365
personally explored or at the hospital observed	114	107	221
deceased	65	251	316
<u>causes of death</u>			
main disease	11	41	52
not in relation to main disease or late effects	11	105	116
unknown	2	14	16
malignant bone tumors, osteosarcoma	27 (+3L)	15(+2L)	42 (+5L)
chondrosarcoma	6	0	6
other malignant tumors (carcinoma)	3 (+2L)	30 (+6L)	33 (+8L)
diseases of the liver (mostly cirrhoses)	1	12 (+14L)	13 (+14L)
diseases of the kidney	2 (+1L)	26 (+3L)	28 (+4L)
panmyelophthisis, anaemia	2	5	7
leukaemia	0	3	3
<u>other late effects</u>			
benign bone tumors			
osteochondroma solitary	14	0	14
multiple	6	0	6
osteochondroblastoma	1	0	1
fibroma	1	0	1
early broken teeth	18	7	25
delay of growth	50	0	50
cataract	8	14	22

L = living patients

Table 2 Exostoses as seen from X-ray picture, juveniles

I) <u>Old list</u>				II) <u>Additional cases</u>			
1	B. K.	♂	multiple	1	B. E.	♂	multiple
2	B. P.	♂	multiple	2	B. E.	♂	multiple
3	F. B.	♀	solitary	3	B. H.	♀	multiple
4	G. R.	♂	multiple	4	L. S.	♀	multiple
5	H. D.	♂	multiple	5	M. O.	♂	multiple
6	H. M.	♂	multiple	6	O. I.	♀	solitary
7	K. H. -P.	♂	solitary	7	R. H.	♂	multiple
8	K. K. -H.	♂	solitary	8	Sch. M.	♀	multiple
9	L. G.	♂	solitary	9	Dr. S. M.	♀	multiple
10	M. H.	♂	multiple	10	S. I.	♀	multiple
11	R. W. +	♂	solitary	11	T. I.	♀	multiple
12	R. S. +	♂	multiple	12	W. E.	♂	solitary
13	S. W.	♂	multiple	13	W. K.	♂	multiple
14	Sch. H. -J.	♂	multiple				
15	Sch. P.	♂	multiple				
16	Sch. W.	♀	multiple				
17	Sch. H.	♂	multiple				

multiple exostoses	male	16	total number	23
	female	7		
solitary exostoses	male	5	total number	7
	female	2		
			<hr/>	
			together	30

Project 5

Epidemiological study on late effects after medical application of ^{224}Ra in ankylosing spondylitis patients

O. Hug, F. Schales

From 1948 up to now about 2 000 patients suffering from ankylosing spondylitis have been treated in several German university hospitals by ^{224}Ra injections.

In 1971 in addition to project 4 a study on possible radiation effects in this group was started. The aim of this study is to calculate the average skeletal radiation doses received by these patients and to correlate them with late effects to be observed by clinical reinvestigations.

The collaboration with 3 hospitals already under contract (Frankfurt, Münster, Hannover) has been continued. Other hospitals in Berlin, Kiel, Aachen and the Landesversorgungsamt Hessen have been asked to support our study. The first patients of these hospitals have been contacted.

A parallel study has been proposed to colleagues of the University of Nancy (France).

Up to now the names of about 100 patients who have died in the meantime have been found. The causes of death will be checked.

The electronic processing of all data collected so far is under way. The first aim is to print out lists of doses and dose rates received by all ankylosing spondylitis patients treated in Germany by ^{224}Ra injections.

This work is done in close contact with project 4 (Prof. Spiess) and using the experiences of the Euratom thorotrast groups.

List of publications

Gössner, W.

Internal Irradiation and Carcinogenesis.

Current Topics in Radiation Research Quarterly 9 (1973) 35 - 39

GSF - B 475

Günzel, I. and W. A. Müller

Bone Mineral Metabolism in Mice after Fracture of Tibiae,

Double Labelling with ^{47}Ca and ^{224}Ra .

Biophysik 10 (1973) 267 - 272

GSF - B 460

Hägele, U.

Strahlenwirkung auf die Proliferation des Nierenepithels nach Bleigabe in Verbindung mit Nephrektomie und temporärer Ischämie.

Verh. Dtsch. Ges. Path. 57 (1973) 395

GSF - B 477

Heuck, F. und W. Gössner

Strahlenempfindlichkeit der Knochen.

Strahlenschutz in Forschung und Praxis, Band XIII. Hrsg. H. Braun et al. Stuttgart: G. Thieme-Verlag (1973) 153-171

GSF - B 500

Luz, A. und W. Gössner

Die alkalische Phosphatase im Dünndarm der Maus bei strahlenbedingter Zottenatrophie.*

Beitr. Path. Bd. 148 (1973) 180-198

GSF - B 440

Marquart, K. -H.

Frühe Ultrastrukturveränderungen in der Tibiametaphyse der Maus nach Inkorporation von Ra-224.

Verh. Dtsch. Ges. Path. 57 (1973) 466

GSF - B 476

* publication from previous project

Müller, W.A.

Report on meeting of the EBONY-group

EULEP-newsletter Nr. 4 (1973) 2-5

GSF - B 490

Reports

Gössner, W.

Pathology requirements in late effects studies.

European Late Effects Project Group (EULEP), First Eulep

Teaching Seminar, 15. -16. November 1973, Schloß Reisenburg

Luz, A.

Experimentell erzeugte Knochengeschwülste nach Inkorporation
der kurzlebigen Alpha-Strahler Radium-224 und Thorium-227.

Wissenschaftliches Kolloquium der Fakultät für Medizin der
Technischen Universität, München, 26. 6. 1973

Marquart, K. -H.

Virus-like particles in ²²⁴Ra-induced murine osteosarcomas.

Centre d'Étude de l'Énergie Nucléaire C.E.N./S.C.K.,

Mol, Belgien, 10.5.1973

Schales, F., R. Keil und Th. Franke

Die natürliche Strahlenexposition des Menschen

- Externe Exposition durch terrestrische Strahlung im Freien -

Symposium anlässlich des 80. Geb. von Prof. Rajewski, Frankfurt, 18.7.1973

Schales, F., R. Keil und Th. Franke

Die natürliche Strahlenexposition des Menschen
- Natürliche Radionuklide im Boden -

Symposium anlässlich des 80. Geb. von Prof. Rajewski, Frankfurt,

18. 7. 1973

Contractual Partner of the Commission:

Prof. Dr. K.E. Scheer, Director of the Institut für Nuklearmedizin am Deutschen Krebsforschungszentrum, Heidelberg.

Contract No.: O63-72-1 PST D

Head of the Research Group: Prof. Dr. K.E. Scheer, Director of the Institut für Nuklearmedizin am Deutschen Krebsforschungszentrum, Heidelberg,

Assistant Head of the Research Group: Prof. Dr. W.J.Lorenz, Institut für Nuklearmedizin, Deutsches Krebsforschungszentrum, Heidelberg.

Coordinator: Dr. G. van Kaick, Institut für Nuklearmedizin, Deutsches Krebsforschungszentrum, Heidelberg.

The contracted research program is to be performed at the Institut für Nuklearmedizin am Deutschen Krebsforschungszentrum, Heidelberg, in collaboration with:

Prof. Dr. H. Muth, Director of the Institut für Biophysik der Universität des Saarlandes (Boris-Rajewski-Institut), Homburg,

Prof. Dr. G. Wagner, Director of the Institut für Dokumentation, Information und Statistik am Deutschen Krebsforschungszentrum, Heidelberg, and

Prof. Dr. A. Kaul, Klinikum Steglitz der Freien Universität Berlin, Nuklearmedizinische Abteilung.

General Topic of the Contract:

Research Project "Thorotrast" - Investigations to Evaluate the Long Term Effects Caused by Artificial Radiation in Man (Thorotrast-Patients).

General description of the performed work:

The goal of the research project was set down after mutual agreement had been achieved in the coordinating committee attended by representatives of the Bundesministerium für Forschung und Technologie, the Deutsches Krebsforschungszentrum and the Institut für Biophysik der Universität des Saarlandes, Homburg.

The research project Thorotrast, supported by the Bundesministerium für Forschung und Technologie and EURATOM includes:

1. Biophysical and clinical examinations of Thorotrast carriers and of patients belonging into a control group.
2. Discovering the fate of Thorotrast carriers and patients of the control group who have already died.
3. Use of radiological, serological and immunological diagnostic methods for the discovery of Thorotrast induced neoplasias.
4. Follow up examinations of patients of the Thorotrast group and the control group and investigate the cause of the death of patients having died since the last examination.
5. Statistical analysis of the obtained results.
6. Determination of the chromosome aberration rate in Thorotrast carriers and non carriers, and the dependence of this to the radiation dose.
7. Experimental examinations to analyse the foreign body irritation and study the results of the radiation emanating from the thorium dioxide agglomerates.

Results of the Project No. 1:

Head of the Project: Prof. Dr. K.E. Scheer (Contractual Partner), Prof. Dr. W.J. Lorenz (Assistant Head of the Project), Dr. G. van Kaick (Coordinator)

Scientific Collaborators of the Institut für Nuklearmedizin:

Dr. R. Bader (since 10.1.73), Dr. J. Clorius, Dr. I. Drings (up to 31.3.73), Dr. U. Herzfeld (up to 30.9.73)

Dr. D. Lorenz and Dr. P. Schmidlin.

Statistical evaluation: Prof. Dr. G. Wagner, Prof. Dr. H. Immich, Dr. H. Wesch.

Project Title:

- a) Search for Thorotrast Patients and for Patients of the Control Group
- b) Clinical and Biophysical Examinations of Thorotrast Carriers and Control Patients.
- c) Investigating the Final Fate of Deceased Thorotrast Carriers as well as of Patients in the Control Group
- d) Follow up Studies.

Title a): The search for Thorotrast carriers in 1973 was carried out in various clinics of Hamburg and Freiburg as well as in a number of Versorgungsämter on the basis of old hospital records. 140 patients were found who had probably received Thorotrast during previous decades due to angiographic examinations. Living Thorotrast carriers were searched for, their present addresses registered. The cause of death of deceased carriers was clarified, as far as possible.

The investigation of patients in the control group was extended into a number of clinics in Berlin, Hamburg, Erlangen and Münster, which had not been included previously. 2600 addresses were found. Depending upon the age and sex of the Thorotrast patients, a selection was made from the random group which had been established for each clinic and assigned to the control group. Still living patients were asked to appear at a medical examination. The cause of death was determined for those who had died.

Title b): 1400 patients from all parts of the Federal Republic have been examined in Heidelberg under the auspice of the Thorotrast program. 100 patients were examined on an outpatient basis in Heidelberg during the last year; 19 other Thorotrast carriers were visited at their home as a result of the mutual work with the research group Homburg (see project No.2). The examinations were performed according to the previous criteria and under identical conditions for both patient groups. In addition we examined the liver sonographically or scintigraphically depending on the clinical findings. As a result of this we were able to discover serious liver tissue damage in a number of patients.

Title c): Since most of the traced patients died in the years between 1945 and 1960 it was necessary to carry on an extended correspondence between the family physicians or the clinics which last treated the patients. Physician's reports, X-ray pictures and obduction results were requested by us and evaluated. The Thorotrast group showed a marked incidence of neoplastic diseases of the liver and the bone marrow as a final cause of death. We found, for example, 98 primary tumors of the liver in the Thorotrast group and only 3 liver tumors in the control group. The tumor incidence of organs which do not incorporate Thorotrast, as for example the stomach, is equally great in the control group as in the Thorotrast group. This result supports the idea that the investigation of both groups was carried out with the same thoroughness and under identical conditions.

Title d): On 64 patients a follow up examination was performed. We detected sonographically and scintigraphically that one patient had developed a haemangioendothelioma of the right lobe of the liver. It was unfortunately not possible to extirpate the tumor due to its disseminated intrahepatic growth pattern.

It was possible to discover the cause of death of 60 patients who have died after being examined more than 2 years ago in Heidelberg. Of these 60 patients 16 had a primary liver neoplasia, and 4 patients developed a leukemia after the first

examination. Similar diseases were not found among the 20 deceased patients who belonged to the control group. These numbers indicate that the incidence of liver and bone marrow neoplasias are continuously increasing for Thorotrast carriers.

List of publications:

van Kaick, G., Drings, P., Lohölter, H.:
Chronische myeloische Leukämie 27 Jahre nach Thorotrast-
Inkorporation.
Strahlentherapie 145, 582-587 (1973)

van Kaick, G.:
Auswirkungen von Thorotrast.
Münch.Med.Wschr. 115, 1147 (1973)

Immich, H.:
Aspects of Collaboration relating to Follow-up-Studies.
Proceedings of the III. International Meeting on the
Toxicity of Thorotrast held at the Finsen Institute
Copenhagen 25.-27.IV.1973.
Danish Atomic Energy Commission. Research Establishment Risø.
Risø Report No.294, June 1973 p. 317

Immich, H.: Statistical Problems of Thorotrast Studies.
Risø Report No. 294, June 1973 p. 148

van Kaick, G., Scheer, K.E.:
Actual Status of the German Thorotrast Study.
Risø Report No. 294, June 1973 p. 157

van Kaick, G., Lorenz, D., Drings, I.:
Special clinical Findings among Thorotrast Patients.
Risø Report No. 294, June 1973 p. 163

Lorenz, D., Lorenz, W.J., van Kaick, G.:
Medical Problems concerning the Control Group.
Risø Report No. 294, June 1973 p. 169

Schmidlin, P., Wagner, G.:
Development and Improvement of the Questionnaires.
Risø Report No. 294, June 1973 p. 151

Wegener, K., Wesch, H., Kampmann, H., Zahnert, R.:
Pathological Findings in the RES (Liver, Spleen, Lymph Nodes,
Bone Marrow) of Thorotrast Patients (histological and
autoradiographic Investigations)
Risø Report No. 294, June 1973 p. 248

van Kaick, G.:
Retrospektive Untersuchungen über Spätfolgen nach
Thorotrast-Applikation.
Report: International Congress on Neoplastic Diseases,
Heidelberg, 4.-8.June 1973

van Kaick, G., Lorenz, D., Drings, I.:
Erkrankungen des Knochenmarks bei Thorotrastträgern.
Report: 79. Tagung der Deutschen Gesellschaft für innere
Medizin, Wiesbaden, 29.4. - 3.5.1973

van Kaick, G.:

Das Thorotrast-Programm.

Report: Präsentation des wissenschaftlichen Programms des Deutschen Krebsforschungszentrums, Heidelberg, 15.3.1973

van Kaick, G., Lorenz, W.J., Scheer, K.E.:

Causes of Death in Thorotrast Patients.

XIII. International Congress of Radiology, Madrid, 15.-20.10.1973

van Kaick, G., Georgi, P., Lorenz, A.:

Kombinierte radiologische Diagnostik zur Beurteilung von Lebererkrankungen bei Thorotrastträgern.

Report: Gemeinsamer Kongress der Deutschen und

Oesterreichischen Röntgengesellschaft 1973,

Wien, 12.-14.April 1973

Project 2: Working group Institut für Biophysik der Universität des Saarlandes, 665 Homburg (Saar).

Head of Project: Prof. Dr. H. Muth

Title a) Clinical and biophysical examinations of thorotrast patients.

Scientific Collaborators: Dr. med. B. Schataneck
Dipl.-Phys. P. Schneider
Ass.-Prof. Dr. W. Kemmer
Prof. Dr. H. Muth
Prof. Dr. Dr. E. Oberhausen

Title b) Chromosome aberrations caused by thorotrast.

Scientific Collaborators: Ass.-Prof. Dr. W. Kemmer
Prof. Dr. H. Muth

Title c) Radiation and non radiation effects of thorotrast, in team work with the working groups Prof. Kaul, Berlin and Heidelberg.

Scientific Collaborators: Ass.-Prof. Dr. W. Kemmer
Prof. Dr. H. Muth

Results of Project 2:

Title a): There exists a group of about 200 persons, having with a high probability thorotrast deposits but are not able to come to Heidelberg or to Homburg (Saar) for reasons of old age or illness. These patients were examined in their home by a physician and a biophysicist. The thoron concentration of the exhaled air of these patients is measured, using a special equipment and method developed at our institute. The equipment is carried along by car. Except whole body measurements and X-ray examination all programmed examinations can be performed. From the thoron concentration measurements the primarily injected amount of thorotrast can be estimated. Up to the end of 1973 about 90 persons of this group had been examined in this way. 72 of these persons

were thorostrast patients, 18 had no thorostrast.

This program (including about 100 more persons) will be continued in 1974.

Title b): In 1973 the examination of chromosome aberrations in thorostrast patients was continued. For this study 7000 metaphases of 70 thorostrast patients were examined. As the aberration yield of patients with similar amounts of injected thorostrast varies within large limits, up to now it is impossible to use a significant dose effect relationship as a basis for a biological indicator of the radiation dose.

There are many possibilities to explain this result:

1. It is possible that "in vivo" damaged cells are eliminated by the body.
2. The thorostrast deposits in the RES are differently conglomerate. Therefore the self-absorption of the alpha particles varies with the size of the thorostrast conglomerations, so that the effective radiation dose and the radiation damage may be different in patients with the same thorostrast amounts in the RES. The effective radiation dose damaging the lymphocytes may therefore not be proportional to the amount of thorostrast formerly injected. The elimination rate of thoron from thorostrast deposits with different conglomerations may be very different too.
3. The variance of the results may be due to changes in the ratio of aberrant to normal cells in the lymphocyte pool, or changes in the relationship between the blood lymphocyte pool and the body lymphocyte pool.
4. In all thorostrast patients relative high deposits of thorostrast were found in lymph nodes, independent on the total RES burden. That means that a high percentage of the total effective radiation exposure of lymphocytes is quite the same. This fact may explain that the chromosome damage in patients with lower amounts of thorostrast injected is relatively high.

Title c): A subcommittee of members of the 3 working groups (Heidelberg, Berlin, Homburg) has elaborated an extensive program for animal experiments on the radiation and non radiation effect of thorostrast and has started the preparations for these experiments. The delay of the beginning of these experiments was mainly caused by difficulties arising from the self-production of the necessary thorostrast and zirconotrast preparations. It is the task of the working group in Homburg to find an answer to the remaining questions written down in b) 1 - 4.

These animal experiments will be started in 1974.

Publications:

The following papers are published in Proceedings of the Third International Meeting on the Toxicity of Thorotrast, held at the Finsen Institute, Copenhagen, 25-27 April 1973, Sponsored by the Danish Atomic Energy Commission, The National Health Service of Denmark and The World Health Organization.

Danish Atomic Energy Commission,
Research Establishment Risø, Risø Report No. 294, June 1973

- (1) GRILLMAIER, R., MUTH, H.: Radiation Dose in Lungs of Thorotrast patients p. 31-39
- (2) KEMMER, W., MUTH, H., TRANEKJER, F., BORKENHAGEN, U.: Chromosome Aberrations caused by Thorotrast, p. 104-113
- (3) MUTH, H., OBERHAUSEN, E., KUNKEL, R., HERZFELD, U.: Expected Late Effects in Thorotrast Patients, p. 320-329

Results of Project Nr. 032-67 PSTD

Part 3:

Research Group Klinikum Steglitz der Freien Universität Berlin

Head of the Project: Prof. Dr. A. Kaul

Scientific Collaborator: Dr. W. Riedel

Technical Collaborator: B. Müller

Title of the Project:

Dosimetry, Foreign Body and Radiation Effects of Thorotrast

Part 3a:

Tissue Distribution, Steady State Activity Ratios and Dose Rates in Man following intravascular Injection of Thorotrast

Published data and results of own investigations on tissue distribution and steady state activity ratios of Th^{232} and daughters in man were compiled in order to get "best estimates" for dose rate calculations in patients with long-term Thorotrast burdens.

According to the results about 95 % of intravascularly injected colloidal ThO_2 are retained by the organs of the reticulo-endothelial-system (RES) of the "standard Thorotrast patient" (liver: 59 %; spleen: 26,5 %; bone marrow: 9,3 %). Only 0,7 and 0,1 % are distributed within the lungs and the kidneys, respectively. The fractional retention of Th^{232} in the marrow-free skeleton proved to be 4 % on the average.

Due to recoil at the moment of their creation by decay, thorium daughters are able to escape from the ThO_2 aggregates in order to be translocated to other organs or to be excreted from the body. Consequently the activity ratios between daughters and Th^{232} in tissues of Thorotrast patients are quite different from those in sealed Thorotrast ampoules of the same age. Thus, in cases of long-term Thorotrast burdens, Ra^{228} is only up to 40 % in equilibrium with its parent Th^{232} in organs of the RES, and in excess to Th^{232} in marrow-free bone in the order of 20 %. The same proves true for Ra^{224} , which is eliminated from the Thorotrast deposits of the RES and partly translocated to the marrow-free skeleton. The corresponding activity ratios between Ra^{224} and Th^{232} yielded 0,25 - 0,36 for the liver, spleen and bone marrow, and proved to be almost 2 for the marrow-free skeleton. In

the lungs Pb^{212} is assumed to be in excess to its parent Ra^{224} by a factor of nearly 20, due to Pb^{212} bound to the cellular fraction of blood, and due to decay of Rn^{220} having been escaped from the RES into the general circulation.

The average steady state activity ratios of Th^{232} within the RES of the "standard Thorotrast patient" proved to be quite comparable to those observed in animal experiments, indicating the elimination of Th^{232} decay products in vivo from ThO_2 aggregates to be a property of Thorotrast itself rather than of the animal.

Estimates of mean organ dose rates for patients with long-term burdens of intravascularly injected Thorotrast (10, 30 and 50 ml) were performed based upon present "best estimates" on tissue distribution and steady state activity ratios of Th^{232} and daughters. Self-absorption of emitted radiation due to aggregation of the ThO_2 particles within the living tissues was considered by application of conventional methods of empirical origin. In addition, long-term (0,125-392 days) animal experiments were done with rabbits, considering the size of the ThO_2 aggregates in vivo, and their variation with time in tissues of the reticuloendothelial system, by analyses of histological sections using a picture analyzing computer ("flying spot analysis").

For an intravascular injection of 50 ml Thorotrast the mean α -ray dose rate in the liver, spleen, and bone marrow proved to be about 40, 120 and 23 rd/year, respectively. The corresponding self-absorption correction factors of α -particles yielded 0,52, 0,29 and 0,87, respectively, if calculated according to conventional methods. By computerized picture analyses of rabbit tissue samples (liver and spleen) containing Th^{232} at comparable concentrations self-absorption correction factors have been calculated which proved to be approximately 0,6 and 0,45, respectively.

Moreover, the results of the animal experiments have indicated the process of aggregation of ThO_2 particles within the liver tissue to be continuing for times of more than 400 days after Thorotrast injection. In the spleen, however, the aggregates size distribution remained nearly constant at times of more than about 150 days after Thorotrast application.

In addition to calculations of mean organ dose rates histological sections of organ samples from a Thorotrast patient were analyzed by quantitative autoradiography for reasons of estimating microscopic inhomogeneities of dose distribution (in collaboration with G. Palme, S. Schiller and B. Roßdorf). In the spleen and liver three and respectively two different regions of α -track concentrations could be distinguished after 30 days exposition of the tissue sections:

spleen: region I: $2 \cdot 10^4$ tracks/mm²
 region II: $2 \cdot 10^3$ tracks/mm²
 region III: $1 \cdot 10^1$ tracks/mm²
liver: region I: $2 \cdot 10^3$ tracks/mm²
 region II: $1 \cdot 10^1$ tracks/mm²

The fraction of the different regions referred to the total area of the tissue sections having been analyzed proved to be as follows:

spleen: region I: 7 %
 region II: 3 %
 region III: 90 %
liver: region I: 1 %
 region II: 99 %

From the number of α -tracks per mm² the local concentration of Th²³² and its daughters was calculated as a basis for microdose estimates. The results indicate that the local absorbed dose is quite different from the mean organ dose and may amount to a factor of 1000.

Part 3b:

Foreign Body and Radiation Effects of Thorotrast

Animal experiments with radioactive and non-radioactive colloids are provided for investigating the foreign body effects in comparison to Thorotrast as potential etiological factor in the tumor genesis. From the particles size distribution of the colloids demanded to be comparable with that of Thorotrast (average diameter = 5,5 nm). For this purpose dextrin stabilized zirconia sol may be applied, as zirconium relates to thorium concerning its chemical properties.

The zirconiumoxidehydrosol was produced by condensating during an electrodialysis.

As recently described the condensation obtained by anion exchange did not yield an appropriate particle size distribution of the colloid.

The electro-dialyzer, manufactured in our institute, was applied as a two chambered type, the electrolyte, which is to be removed, being HCl. Cation and anion chamber are separated by an anion permeable membrane. The anion compartment was rinsed continuously by bidistilled water. In order to accelerate the olation and oxolation processes the cathode fluid was pumped continuously through a heating coil (90 - 95° C), a cooling coil, and finally through a niveau vessel. The capacity of the complete equipment amounts to 400 ml. The pH-value is permanently measured.

The electro-dialysis, however, causes gelation even on a relatively low pH-level. The amorphous sols obtained are to be autoclaved at 150° C during 15 hours, thus converting this material into cristalloidal sols which are consistent with pH-variations. The neutralisation of the sol was accomplished by means of 2n NaOH after stabilizing with dextrin.

A sol containing 13 % ZrO_2 (Zirconotrast) as applied by others, however, settled after heating. Therefore diluted sols were evaporated as far as to the desired concentration.

Different $ZrOCl_2$ solutions equivalent to 3 % ZrO_2 (sol 1), 1 % ZrO_2 (sol 2), and 0,3 % ZrO_2 (sol 3) were electro-dialyzed. Electronmicrographs of these zirconia sols showed the following distribution of the particle diameter:

sol 1: 7 - 70 nm, sol 2: 7 - 55 nm, sol 3: 3 - 24 nm.

Sol 3 reaches almost the particle size distribution of the disperseids of Thorotrast.

Thoriumdioxide sols of our own production as described previously in the 1972 EURATOM report were injected into test animals (mice) in different amounts (25 μ l to 250 μ l) in order to study activity ratios and distribution as function of time after application of this sol.

The results of these investigations are basic for dose calculations in long term animal experiments on foreign body and radiation effects of Thorotrast.

Literature

- Kaul, A.: "Tissue Distribution and Steady State Activity Ratios of Th²³² and Daughters in Man following intravascular Injection of Thorotrast"; presented on the 3rd International Meeting on the Toxicity of Thorotrast, 24.-27. April 1973 in Copenhagen.
- Kaul, A.; Abmayr, W.; Hindringer, B.: "Mean Organ Dose Rates in Man following intravascular Injection of Thorotrast"; presented on the 3rd International Meeting on the Toxicity of Thorotrast, 24.-27. April 1973 in Copenhagen.
- Riedel, W.; Müller, B.; Kaul, A.: "Non-Radiation Effects of Thorotrast and other Colloidal Substances"; presented on the 3rd International Meeting on the Toxicity of Thorotrast, 24.-27. April 1973 in Copenhagen.

Contractant de la Commission: C.E.A.

N° du contrat : 100 - 72 - 1 - BIAF

Chef du Groupe de Recherche: J. LAFUMA

Thème général du contrat: Toxicologie de certains
éléments chez les animaux et chez l'homme.

En 1973, les recherches sur l'action toxique des radioéléments inhalés se sont développées rapidement. Les courbes de survie ont été obtenues pour plusieurs actinides et lanthanides sous diverses formes physico-chimiques. De nombreux cancers ont été observés dans les poumons ou dans d'autres organes.

D'autres travaux ont porté sur l'action cancérogène locale d'émetteurs β injectés par voie intra-musculaire.

Les études thérapeutiques se sont poursuivies en 1973.

Résultats du projet n° 1

Chefs du projet et collaborateurs scientifiques:

Mme SKUPINSKI

M. BATTI

Titre du projet: Métabolisme des éléments toxiques

Les études métaboliques ont porté en 1973 sur des oxydes d'Amercium²⁴¹ calcinés à 400 ou 700 degrés C., sur des oxydes de Plutonium²³⁸, des oxydes de Cerium 141 et enfin une solution de Chlorure de Cerium 141.

Si l'on récapitule les valeurs métaboliques moyennes des différents éléments utilisés chez le rat pour des recherches de pathologie à long terme, on a les résultats suivants:

Tableau 1
Métabolisme pulmonaire

Elément	(Période d'épuration alvéolaire (jours)	Fraction (F)	(Période d'épuration de) (F (jours))
(Oxyde de Pu 238	(30	(0.10	(500)
(Nitrate de Pu 238	(20	(0.04	(250)
(Oxyde de Pu 239	(120	(0.04	(500)
(Nitrate de Pu 239	(60	(0.02	(250)
(Oxyde d'Am ²⁴¹	(12,5	(0.01	(250)
(Nitrate d'Am 241	(12,5	(0.015	(250)
(Nitrate de Cm 244	(8	(0.01	(250)
(Oxyde de Ce 141	(120	(0.04	(250)
(Nitrate de Ce 141	(60	(0.05	(250)
(Nitrate de Ce 144	(20	(0.05	(250)

F est la fraction de l'activité initiale qui s'épure plus lentement.

Au niveau des organes, on note les valeurs moyennes suivantes:

Tableau 2

Elément	Foie		Os	Rein
	F _{f1}	F _{f2}		
Pu238 Oxyde	0,02	0,004	0,05	0,008
Pu238 Nitrate	0,20	0,04	0,25	0,01
Pu239 Oxyde	0,02	0,004	0,05	0,008
Pu239 Nitrate	0,20	0,01	0,25	0,01
Am241 Oxyde	0,20	0,004	0,25	0,03
Am241 Nitrate	0,20	0,04	0,20	0,025
Cm244 Nitrate	0,07	0,015	0,25	0,035
Ce141 Oxyde	0,02	0,004	0,05	0,008
Ce141 Nitrate	0,20	0,01	0,20	0,05
Ce144 Nitrate	0,20	0,01	0,25	0,08

Si l'on donne la valeur unitaire à la quantité qui quitte le poumon, F_{f1} est la fraction de cette quantité qui va dans le foie, F_o est la fraction de cette quantité qui va dans le squelette et F_r est celle qui va se fixer dans le rein. Le reste est éliminé. Le foie se vide avec une période de 8 jours à l'exception de la fraction F_{f2} qui, elle, s'épure avec une période de 500 jours. L'os et le rein ont des périodes que l'on peut fixer à 1.000 jours.

-:-:-:-

En plus de ces études sur le métabolisme pulmonaire, des recherches sur l'action toxique des hydroxydes de Ce144 injectés par voie intramusculaire ont été entreprises. De nombreux ostéosarcomes et fibrosarcomes ont été observés au point d'injection. L'expérience ne sera terminée qu'en 1974.

Enfin, des recherches ont débuté pour comparer l'action toxique d'éléments stables (méthylmercure) à celle des radioéléments. La mise au point des dosages est terminée et l'étude métabolique va commencer.

Résultats du projet n° 2

Chef. du projet : Dr. NENOT

collaborateur scientifique : Melle MORIN

Titre du projet: Etude des effets pathologiques
des éléments toxiques.

Les recherches sur les effets à long terme des actinides sous diverses formes physico-chimiques après inhalation par le rat se poursuivent en collaboration avec le Laboratoire de Toxicologie Expérimentale du C.E.A.

A la fin de 1973, on peut faire un premier bilan.

Les expériences menées avec l'Oxyde de Plutonium-239 sont terminées. Elles ont porté sur 166 rats et ont permis de dégager la courbe reliant la durée de survie à l'activité inhalée.

Les activités inhalées ont délivré aux animaux de 10 à 240 milliards de particules α par gramme de poumon. De 10 à 110 milliards de particules, on a observé des cancers du poumon (105). Les activités cumulées par gramme de squelette ont varié de 0,1 à 0,6 milliards de particules α par gramme d'os ($M = 0,25$). Sur les 85 animaux ayant vécu plus d'un an on n'a observé aucun ostéosarcome.

Les expériences avec tous les autres actinides ne sont pas terminées. Avec le Nitrate de Plutonium-239 (50 rats) on a observé 9 cancers du poumon et deux ostéosarcomes. Les activités cumulées ont varié par gramme de tissu de 3 à 160 milliards d' α pour les poumons et de 0,2 à 3 milliards d' α pour le squelette.

Avec le Nitrate de Plutonium-238 les expériences portent sur 56 animaux et on a déjà observé 6 cancers du poumon et 3 ostéosarcomes pour les activités cumulées par gramme d'organe allant de 8 à 15 milliards d' α pour le poumon et de 2,5 à 10 milliards d' α pour le squelette.

Avec l'oxyde d'Americium-241, les expériences portent sur 186 rats. Aucun d'entre eux n'a encore atteint une survie d'une année et aucune tumeur n'a été observée. Les activités cumulées prévues par gramme de poumon croissent de 1 à 300 milliards d'a et par gramme de squelette elles croissent de 0,5 à 15 milliards d'a.

Avec le nitrate d'Américium-241, les expériences portent sur 156 rats. Les activités cumulées prévues vont de 5 à 75 milliards d'a par gramme de poumon. On a déjà observé 12 cancers du poumon et 6 ostéosarcomes. Les expériences de Nitrate de Curium-244 portent sur 145 rats. Les activités cumulées prévues iront pour le poumon de 0,5 à 40 milliards d'a et pour le squelette de 0,1 à 15 milliards d'a par gramme d'organe. Enfin, les expériences menées avec l'Oxyde de Pu-238 ont été commencées au deuxième semestre 1973. On n'a encore rien observé. Il en est de même avec le Th227 (collaboration avec le Dr. W. MÜLLER). En résumé, les expériences ont porté sur près de 850 rats et l'on a observé 132 cancers du poumon, 11 ostéosarcomes et 3 autres cancers.

Le tableau 1 résume ces résultats:

Elément	(Période bio- (logique du (poumon(jour)	(Milliards (d'a par (gramme de (poumon	(Nrats ((Cancer (pou- (mon	(Autres (Cancers
Oxyde de Pu 239	(120	(10-240	(166	(105	(0
(Nitrate de Pu239	(60	(3-160	(50	(9	(3
(Oxyde de Pu238	(30	(1-20	(48	(-	(-
(Nitrate de Pu238	(20	(10-20	(56	(6	(4
(Oxyde d'Am241	(12.5	(1-300	(186	(-	(-
(Nitrate d'Am241	(12.5	(5-75	(156	(12	(7
(Nitrate de Cm244	(8	(0,5-40	(145	(-	(-
(Chlorure de Th227	(20	(1-10	(36	(-	(-

Si l'on analyse les courbes de survie, on voit que quel que soit l'élément inhalé, il existe deux périodes de mort; la première rapide va de 10 à 120 jours, la seconde

tardive qui va de 200 jours à la fin de la durée de vie. Il existe une activité cumulée pour laquelle une moitié des rats mourra dans la première phase et l'autre dans la seconde. Si l'on compare, pour chacun des éléments le nombre d' α cumulés par gramme de poumon nécessaire pour obtenir ce résultat, on obtient le classement suivant: Oxyde de Pu239, Nitrate de Pu239, Nitrate de Pu238, Nitrate d'Am241, Nitrate de Cm244.

Il existe un facteur 5 entre les valeurs de l'Oxyde de Pu239 et du Curium244. Il existe un facteur 2 entre le Nitrate d'Am241 et le Nitrate de Curium244, et même si l'on exprime le résultat non plus en activités cumulées mais en activités déposées, on voit que le Curium est plus toxique que l'Américium 241. La toxicité à moyen terme croit avec la dispersion de l'élément et l'on n'a pas encore le recul suffisant pour voir si cela est aussi vrai pour le cancer et le raccourcissement de la durée de vie.

Les cancers pulmonaires observés sont de plusieurs types histologiques: carcinomes épidermoïdes (100), carcinomes bronchiolo-alvéolaires (78), carcinomes alvéolaires (1), adénocarcinomes bronchogéniques (7), autres formes (7). Ils ne provoquent que rarement la mort de l'animal et métastasent surtout dans le médiastin et les chaînes lymphatiques. Aucun lymphosarcome n'a été encore observé.

On n'a encore observé que peu d'ostéosarcomes (Tableau 2):

Milliards d' α par gramme d'os	Rats morts après 1 an	Nombre d'ostéosarcomes
0.1 - 1	92	0
1. - 5.	57	5
5. - 10	13.	6
> 10.	4.	0.

Si l'on compare les cancers du poumon et les ostéosarcomes pour les divers actinides, on a les résultats suivants:

Elément	(Pu239Oxyde	(Pu239Nitrate	(Pu238Nitrate	(Am241Nitrate
Poumon Os	105/0	9/2	6/3	12/6

Ce bilan est provisoire et en 1974 devraient apparaître les premières données avec l'oxyde d'Am241 et le Nitrate de Curium 244 dont la période biologique pulmonaire est très courte.

-:-:-:-:-

Les recherches sur les effets des lanthanides se sont poursuivies et l'on peut faire le bilan suivant en ce qui concerne les inhalations.

Elément	Période pulmonaire (jours)	Milliards de B par gramme	Nrats	Cancers poumon	Autres cancers
(Chlorure de Ce144	(30	(20-500	(88	(1	(1
(Oxyde de Ce141	(30-120	(5-800	(119	(1	(0
(Chlorure de Ce141	(60	(30-40	(48	(-	(-
(Chlorure de Y 90	(20	(500	(12	(0	(0
(Oxyde de Cerium stable	(30-120	(-	(72	(-	(-

Deux cancers du poumon ont été obtenus l'un avec le chlorure de Cerium144, l'autre avec l'Oxyde de Cerium141. Dans ce dernier cas, la dose délivrée était si basse (50-100 rads) que nous avons lancé une expérience pour étudier la toxicité de l'Oxyde de Cerium stable que nous activons pour obtenir l'oxyde de Ce141.

En 1974 on devrait avoir suffisamment de résultats pour comparer les β et les α .

Résultats du projet n° 3

Chefs du projet: M. MULLER
M. SCHORN

Titre du projet: Etudes thérapeutiques des
contaminations internes.

En 1973, les études de décorporation ont porté sur trois éléments: Cs137 (Bleu de Prusse), Radium 224 et Plomb 212 (cryptateurs). Les expériences portant sur le Radium 224 et le Plomb 212 ont été menées en collaboration avec M. Walter MÜLLER (Münich).

Une nouvelle méthode de préparation du Bleu de Prusse a permis d'augmenter l'efficacité et on n'a pas observé de toxicité comme l'avait fait CATSCH et BOZORGZADEH lors d'un traitement à long terme. Ce Bleu de Prusse est particulièrement efficace pour le Césium et le Thallium.

Différents cryptateurs ont montré, comme le laissait prévoir la théorie, une bonne efficacité vis à vis du Ra224. Par contre, le métabolisme du Plomb n'est que peu influencé par cette thérapeutique.

Les études sur l'action des corticoides sur le nombre et la mobilité des macrophages alvéolaires se sont poursuivies en 1973. S'il est possible d'agir sur l'un et l'autre de ces deux facteurs, l'intensité de l'action reste faible chez le rat. La poursuite de ces recherches nécessite l'utilisation des primates dont les modalités d'épuration pulmonaire sont plus comparables à celles de l'homme que ne le sont celles du rat.

Commission Associate: ENEL - Ente Nazionale Energia Elettrica.

Contract number: O62 - 72 - 6 - PST 1

Head of research team: Prof. Antonio Farulla

General subject of the contract: Effects of prolonged exposure to low levels of ionizing radiation; morphological cytochemical and cytogenetic researches on circulating lymphocytes of subjects professionally exposed to the hazard of ionizing radiation in a nuclear power station of ENEL.

In 1973 cytogenetic investigations continued through chromosome analysis of circulating cultured lymphocytes on workers professionally exposed to ionizing radiation.

Fifty-one workers of ENEL's Garigliano nuclear power station were checked and ten individuals were used for controls; the control group is made up of healthy persons, aged between 29 and 53, who are not professionally exposed to ionizing radiation or myelotoxic substances and have not been subjected in the past few years to radiological checkups entailing significant exposure.

The histochemical investigations concern the study of biochemical and metabolic transformations during the activation in a culture and may represent very sensitive tests of the cell damage caused by small doses of radiation such those absorbed by professionally exposed workers. Of these modifications particular importance is attached to those relating to the lysosomal enzymes, to the reactivity of chromatin to acridine orange and to protein synthesis.

In this framework investigations were undertaken on the role of acid or non-histone proteins in cell differentiation; this study includes the electrophoretic examination of lymphocytes acid proteins and the separation of the various fractions of these proteins by ultracentrifugation.

Publications:

- A. Farulla, G. Naro et alii: Gli esami citogenetici nella prevenzione del danno radioindotto. XVIII Congr. Naz. A. I. F. S. P. R., Roma 20-22 novembre 1973.
- A. Farulla, V. Monesi, G. Naro: Studies on the carlogram of lymphocytes from radiation workers and on some cellular activities of lymphocytes in culture. 3rd Congr. of I. R. P. A., Washington, 9-14 september 1973.
- A. Farulla et alii: Analisi di alcuni costituenti delle membrane plasmatiche dei linfociti B e T. Arch. It. Anat. Embriol., in press.
- A. Farulla et alii: Analisi elettroforetica delle proteine delle membrane plasmatiche dei linfociti B e T. Arch. It. Anat. Embriol., in press.
- A. Farulla et alii: Interazione DNA-istoni totali. Sfingomielina. Arch. It. Anat. Embriol., in press.

Results of project n. 1

Head of project and scientific collaborators: A. Familla - C. Biagini - V. Monesi - G. Naro

Project title: Effects of prolonged exposure to low levels of ionizing radiation; morphological cytochemical and cytogenetic researches on circulating lymphocytes of subjects professionally exposed to the hazard of ionizing radiation in a nuclear power station of ENEL.

Cytogenetic Surveys.

Technical and diagnostic data. In 1973 the workers had absorbed an external radiation dose varying between 500 and 3,400 mrem. The total dose registered ranges from 12 to 24 rem. The usual procedures based on the techniques developed by Moorhead, on the Denver convention and on the classification devised by Buckton were adopted. The culture times ranged from 48 to 52 hours, and in some cases a parallel 72-hour culture was prepared to have a greater number of mitotic cells. No meaningful differences have been noticed between cultures of different durations.

Results and conclusions.

A total of 3,927 mitotic cells were examined on the 51 cultures of exposed workers. The incidence of aneuploidy (165 cells, of which 149 were hypodiploid and 16 hyperdiploid) was 4,2% and the cells with chromatid aberrations (breaks and gaps) were 7,2%. No cell presented chromosome-type aberrations. In the 169 mitotic cells studied from the ten cultures of the control individuals, 3,9% of aneuploidy was found - with a clear predominance of hypodiploidy also in this case - and a 4% occurrence of cells with chromatid aberrations. No cell exhibited chromosome-type aberrations.

From the foregoing data it is possible to draw a few conclusions of interest to radioprotection. In the examined workers no chromosome alterations due to radiological exposure (dicentric, ring chromosomes, etc.) have been observed nine years after they started working in a nuclear station with a built-up of doses up to 24 rem. This is in conflict with the observations of other Authors (M. Bauchinger et alii in "Advances in Physical and Biological Radiation Detection", I.A.E.A. 1971) who report a higher percentage of chromosomal anomalies in exposed vs. unexposed individuals. Upon examination of the published data, the increase is mostly due to chromatid aberrations, a phenomenon we pointed out in our previous reports and noticed again in our 1973 cytogenetic analyses.

The increase in chromatid aberrations as a result of exposure to radiation can be explained by the results given in this and in the 1972 report on the characterization of the cell population in a culture. These results indicate great heterogeneity of the elements undergoing blastic transformation, some of which can be found in a late G₁ stage in the blood stream and can therefore show a chromatid, rather than a chromosome, aberration after irradiation.

It thus appears advisable not to base any human cytogenetic investigations only on the search for chromosome-type aberrations, but to take into account also chromatid-type aberrations even though their meaning and importance are not yet quite clear.

Histochemical and metabolic research.

Material and methods. Suspensions of human leucocytes were obtained with the standard method described earlier. For the histochemical studies, 2×10^6 cells, suspended in 5 cc of TC 199 medium with 20% calf serum, were seeded in Petri dishes containing slides and incubated for different times at 37° in a 5% CO₂ atmosphere. One hour after the seeding PHA was added and after different time intervals the slides were washed with a physiological solution, fixed, stained with acridine orange or treated with the Gomori-Takamatsu method for alkaline phosphatase.

For the research work on protein synthesis, the cultures were labelled with variable doses of ^3H -leucine at different times after the PHA addition. Then the cells were centrifuged, suspended in non-radioactive medium containing an excess of cold leucine to stop incorporation, and centrifuged again. Distilled water was then added to dissolve the cells and the sample was treated with TCA to a final concentration of 10% in order to precipitate RNA. The precipitate was collected on a millipore filter; the filtrate was counted with a liquid-scintillation counter. The radioactivity, expressed in counts per minute, concerned the total protein acid-precipitable.

Results and discussion.

The study of the modifications of the lysosomal enzymes in lymphocytes following stimulation with PHA is of considerable interest in that some of the research work appears to demonstrate that the release of lysosomal enzymes constitutes a stimulating factor for the blastic transformation of lymphocytes in a culture. In our research we have noted a considerable increase in the activity of alkaline phosphatase in cultures treated with PHA as compared with the control cultures; the increase can be observed after ten hours, continues still the 20th hour and then decreases slowly. It should be noted that also these modifications involve only a portion of the cells, which varies from 30 to 50% in the various experiments. This result is a further support of the general assumption that the lymphocyte population is functionally heterogeneous. The studies with acridine orange confirmed that in a percentage of lymphocytes stimulated with PHA there is an increase in the capability of chromatin to bind the basic dye. The results therefore show that the number of free DNA phosphate groups increases in the activated cells and that the amount of histone bound to DNA decreases in activated lymphocytes. Considering the role that histones play in genome repression, the results obtained offer a possible interpretation of the increase of the transcription processes in activated lymphocytes. From the preliminary results on protein synthesis it has emerged very clearly that the rate of incorporation of radioactive aminoacids increases considerably in the PHA-treated population as compared with the control population, concurrently with an increase in the total RNA synthesis.

Research has been initiated on professionally exposed individuals with the aim of exploring the modification of the histochemical and biochemical parameters with respect to the control population. The preliminary results indicate that protein synthesis is not significantly affected while alkaline phosphatase activity is somewhat reduced in exposed individuals as compared to the control population.

Contracting party of the Commission :
EUROPEAN LATE EFFECTS PROJECT GROUP (EULEP)
Contract number : 092- 72-1 BIO C
Chief of the research group : C.F. HOLLANDER
General object of the contract :
PERFORMANCE OF A CO-OPERATIVE RESEARCH PROJECT ON LATE SOMATIC
EFFECTS OF IONIZING RADIATION IN MAMMALIAN ORGANISMS

EULEP has pursued his efforts during the year 1973 on the standardization of the experimental conditions in the participating institutions, on the coordination of the planning and performance of on going research projects in the area of radiation late effects, as well as in the unification of specific cooperation projects on carcinogenesis, on dysplasia and dystrophia lesions and on the toxicity of radioisotopes. A training programme on late effects research as well as on specialized topics has been initiated.

STANDARDIZATION COMMITTEE

- B-1. Standardization of radiation dosimetry
- B-2. Standardization of conditions for animal experimentation
- B-3. Standardization of histopathology
- B-4. Standardization of laboratory methods

SPECIFIC COOPERATIVE PROJECTS

- B-6. In the field of carcinogenesis
- B-7. In the field of the non-neoplastic changes
- B-8. In the field of internal radioisotope toxicity
- B-9. Teaching programme

Results of project N° 1

Head of the project : J.J. BROERSE

Title of the project : COMMITTEE ON DOSIMETRY STANDARDIZATION

A first intercomparison project on X-ray dosimetry performed in 1970 and 1971 has indicated a number of discrepancies with respect to the absolute X-ray dosimetry and the exposure conditions employed at the various institutes cooperating within EULEP. The results of the first project have been evaluated and a protocol for EULEP X-ray dosimetry and a code of practice have been prepared. A second series of intercomparisons of absorbed dose and dose distribution has been carried out in the past year with the aim to check the improvements made after previous intercomparison studies. Furthermore, the second EULEP intercomparison was directed to the actual exposure conditions employed at the various institutes. The participants were asked to irradiate a mouse phantom, containing a set of thermoluminescent (TL) dosimeters, in the cage used for mouse irradiations at the participating institutes.

The procedure for handling the thermoluminescent material (Con-Rad ⁷LiF powder) was the same as during the first intercomparison project. The test and control capsules were subjected to a post-irradiation treatment on return from the institutes. Special attention has been paid to the energy dependence of LiF and the relevant corrections to be applied for the irradiations free-in-air and in the phantom for different HVL values of the incident beam. These corrections have been measured in separate experiments. The LiF data from the participating institutes have been compared with those obtained from an exposure at a standardization laboratory.

The results of the second intercomparison project on absorbed dose and dose distributions are summarized in figures 1 and 2, together with the results of the previous EULEP intercomparison. It can be seen from figure 1 that a number of institutes have improved considerably their absolute X-ray dosimetry ;

although 3 out of 11 institutes still obtain dose values which are not within 5% of the standard dose. From figure 2 it can easily be seen that improvements have also been made with respect to the uniformity of the irradiation, since the first intercomparison showed that 4 out of 9 institutes could perform mouse irradiations under conditions of uniform irradiation (a ratio of less than 1.15 between maximum and minimum absorbed dose), whilst the indication from the present intercomparison is that 10 out of 13 fulfill their requirements.

In general, it can be concluded that the intercomparison project has induced a considerable improvement in dosimetry procedures (absolute dosimetry and exposure conditions), employed at the various institutes cooperating within EULEP. For a few institutes, further improvements in the X-ray dosimetry arrangements should be made.

RESULTS OF EULEP X-RAY DOSE INTERCOMPARISON

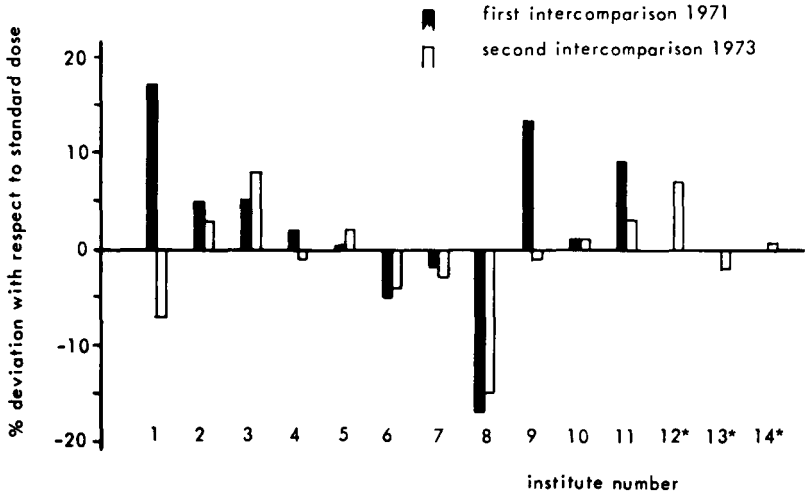

* these institutes participated only in the 1973 intercomparison

RESULTS OF EULEP X-RAY DOSE DISTRIBUTION INTERCOMPARISON

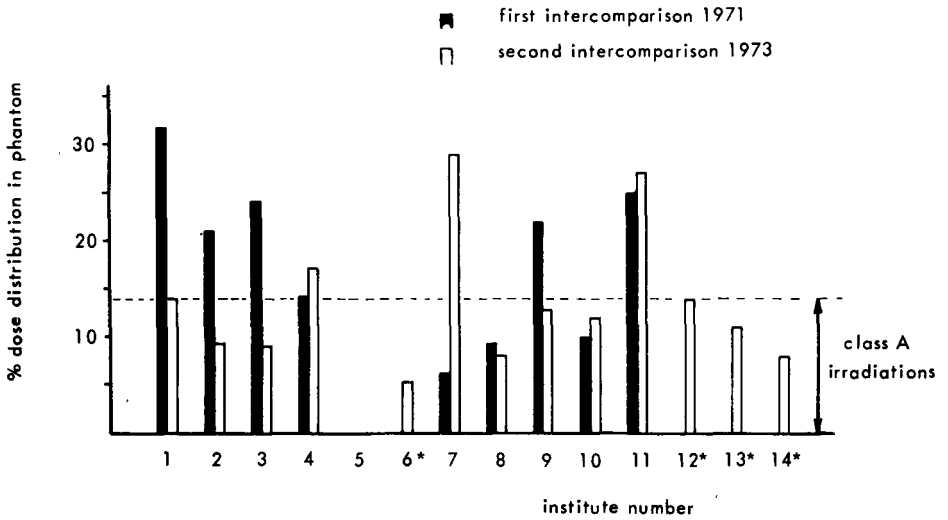

* these institutes participated only in the 1973 intercomparison

Results of project N° 2.

Head of the project : H.P. SCHNAPPAUF

A. DUNJIC (since November 17)

Title of the project : COMMITTEE ON LABORATORY ANIMALS
STANDARDIZATION (CLAS)

As announced in the previous annual report, the First CLAS Training Meeting was held in Louvain on May 13, 1973. Various aspects involved in long-term experiments with mice and rats were presented by invited speakers. The proceedings of this meeting were sent to regular committee members or official laboratory representatives for further discussion and will be made available to all members in one of the next issues of the EULEP Newsletter. In addition, the first LD 50/30 determinations were presented, but no common agreement was reached to start microbiological and food control studies in the immediate future due to the expense involved.

The Second CLAS Meeting in 1973 was held at the Reisenburg November 14-15 and 18th. The results of the second run of LD 50/30 determinations were presented. Proposals concerning longevity studies to be carried out in 1974 were discussed. The inventory of animal strains maintained in the participating laboratories was commented on.

The subcommittee on longevity studies met in Louvain on December 10 and 11th, 1973, to initiate the practical procedures of the 1974 project.

The LD 50/30 determinations

A first interim report was circulated in June 1973. A final report including the second set of determinations will be available in January 1974. Further LD 50/30 studies will be carried out in 1974 and an enlarged intercomparison study is planned which, in addition to the experiments already carried out specifically for EULEP will use estimates of the LD 50/30 obtained repeatedly in previous years with a same strain.

The inventory

The first listing of mouse and rat strains actually maintained in the participating laboratories was made in November 1973. Information concerning the type of experiment for which the strains were used was also provided. The international nomenclature for inbred and outbred animals was followed as far as possible.

The use of F1 hybrids is recommended for non-neoplastic studies because they are less influenced by the environment. For mice this can be achieved in most of the laboratories, but only 5 laboratories possess inbred rats.

Longevity studies

Following the last CLAS Meeting, nine laboratories agreed to start coordinated experimentation in 1974. Two laboratories are not directly interested but one already possesses longevity data while the second wishes to participate as observer due to its restricted animal accommodations. A formal agreement is expected from three more laboratories.

Results of project N° 3 ..

Head of the project : W. GOSSNER

Title of the project : COMMITTEE ON PATHOLOGY STANDARDIZATION

In 1973 two workshops with the main topic of "Tumors of hematopoietic tissue in mice" have taken place in Munich.

In the workshop on April 7-8 1973, different cases (22) of reticulum cell sarcoma, lymphosarcoma and myeloid leukemia in mice were presented. On the basis of existing classifications in the literature and proposals of the members of the committee, a first draft for classification of tumors of hematopoietic tissues in mice has been adopted. In addition, cases (4) of reticulum cell sarcoma in rats was presented.

The importance of standardized histological technique in general and the usefulness of enzyme histochemical methods for differentiation of different types of leukemia was discussed.

A peculiar lesion of the stomach in mice, which shows a transition between adenomatous hyperplasia and surface carcinoma was also demonstrated.

In the workshop on December 1-2 1973, Dr H.L. Stewart (Registry of Experimental Cancers, National Cancer Institute, Bethesda/U.S.A.) gave a lecture on "Hematopoietic neoplasms and some confusion conditions". This lecture was based on cases (41) of lymphosarcoma, reticulum cell sarcoma (Type A, B, C), malignant schwannoma, plasma cell tumor, mast cell neoplasm, granulocytic leukemoid reaction, granulocytic neoplasm, mesenteric disease, thymectomy effect, germ-free state, thymic rest and lymphoid body, reticulum cell alterations in SJL/J mice.

Microscopic slides of these cases were distributed to all member institutes and will be kept in the registry of the committee.

Prof. Dr L. Chieco-Bianchi (Department of Experimental Oncology, Institute of Pathological Anatomy and Pathological Histology, University of Padova/ Italy) gave a lecture on "Morphological and biological aspects of lymphatic

tumors in mice". This lecture was mainly concerned with the relationship between lymphoid and myeloid leukemia in mice with regard to their pathogenesis. Histological slides of 5 representative cases were made available for the member institutes and the registry.

Additional cases were demonstrated by members of the committee. This discussion has shown that there may still exist difficulties in the differential diagnosis of reticulum cell sarcoma type A or B.

The members of the committee came to the conclusion that on the basis of valid morphological criteria the following nomenclature may be used for the diagnosis of tumors of hematopoietic tissues in mice :

Reticulum cell sarcoma	Plasma cell tumor
type A	
type B	
Lymphosarcoma	Mast cell tumor
thymic	
nonthymic	Myeloid leukemia

Useful additional information concerning the morphology as well as the biological or functional behaviour of these neoplasms will be obtained by

- a) recording the site of the lesions
- b) histochemical, especially enzyme histochemical, studies of the tumors
- c) immunological testing of neoplastic cells.

Dr Stewart gave a survey of the organization and the work of the Registry of Experimental Cancers in the National Cancer Institute, U.S.A.

Finally, certain problem cases which were sent to the consultation centre were presented and discussed.

Results of project N° 4

Head of the project : A. KEYEUX

Title of the project : COMMITTEE FOR CLINICAL PATHOLOGY
STANDARDIZATION

The Committee was asked to cooperate in two projects of standardization and coordination

- a) Physiological methods involved in the CNS/vascular project
- b) Criteria and tests for the response of antilymphocytic serum (ALS) and antilymphocytic Gammaglobulin (ALG) in rats and Mice. The latter project is required for the research of the Committee of Carcinogenesis.

The first project required only mutual cross checking by the users and did not involve any expenses. For the second project, a "Development Immune Monitor Subgroup" (DIMS) was formed, which selected methods and techniques to be used for standardization, established principles for treatment schedules for short and long term experiments and agreed on criteria to evaluate long term toxicity of ALS preparations particularly on its effect on life span.

The following tests have been made operational :

PHA response of rat or mouse spleen cells, Mitogen response of rat peripheral lymphocytes (all in Rijswijk), Dutton type test (Rome), action of ALG on mice infected with Rauscher Leukemia Virus (Ulm), Brunners test for lymphocyte cytotoxicity (Louvain), immunoglobulin levels after inoculation with radiation leukemia virus (Mol).

The following observations were reported so far.

A batch of ALS initially tested was found to be rather selectively against T cells. For long term experiments, natural antibody measurements seem to be most suitable (Rome). Maximum immunosuppression on a short term basis is best obtained by treatments with as high a dose as desired, for a total time of less than 6 days (testing times 0,3 and 6 days).

Long term immunosuppression in mice may be achieved by injecting ALS 8 times over a period of 26 days (Mol). In rats, a treatment schedule of twice weekly injections over 3 months is possible (Louvain).

Chronic toxicity of ALS (injected for 12 weeks) is evaluated on the basis of peripheral blood counts as well as of organ histology (lymphnodes, spleen, lung, bone marrow, kidney, thymus, intestinal tract, brain, liver, pancreas) 1, 3 weeks and then at monthly intervals after starting the treatment.

Results of project N° 6

Head of the project : H. SEIDEL

Title of the project : COMMITTEE ON CARCINOGENESIS

A. During 1973 the program of the Committee "Estimation of the risk of malignant transformation as a consequence of exposure to ionizing radiation" was continued. Besides individual programs on this line coordinated research was performed within 2 subgroups :

I. "Cells at risk" (Lindop, London and Metalli, Rome)

Hemopoietic tissue of mice is exposed to ionizing radiation under varying conditions and transplanted to restore lethally irradiated animals. Special attendance is given to the size of the cell inocula and the number of stem cells transplanted. The animals develop different tumors, mainly myeloid leukemias in the one model or reticulum cell sarcomas in the other, where syngeneic chimeras are used as the experimental model. These systems may be used for investigating the induction of tumors on a "per-irradiated-cell" basis.

During a committee meeting a new series of experiments was suggested including additional parameters as origin of donor cells and age of the donor animal. Results can be expected during 1975. The pathogenesis of reticulum cell sarcoma in mice, a very consistant tumor in a special strain at Rome was chosen for a study of two main problems ; wether a viral agent could be involved and wether the frequency and latency time of the tumor could be modified by radiation. First results indicate the usefulness of this approach.

Lit. : Covelli et al. Tumori 59, 97-118 (1973).

II. "Immune status and DIMS" (van Bekkum, Rijswijk ; Doria, Rome ; Flad and Seidel, Ulm ; Jovanovic, Louvain ; Sassen, Mol)

This group met 3 times during 1973 and agree on a list of standardized tests for mice and rats for the purpose of immune monitoring during

the phase of carcinogenesis (DIMS = development immune monitor subgroup). Ultimately, the program will attempt to correlate tumor incidence with the immunosuppressive effects of radiation exposure. The assays developed in the participating laboratories so far were performed with a standard ALS preparation. Detailed descriptions of a selected minimal package of suitable monitors will be circulated at the beginning of 1974.

Besides this methodological and developmental work, the role of the immune system was studied in the different models used with interesting results by Sassen/mol where the effect of immune suppression and stimulation on the incidence of lymphoid tumors in mice by RadLV was evaluated.

In 1974, this subgroup will finish the standardization of techniques to follow up immunological reactivity and the evaluation of chronic toxicity of ALS preparations. The standardization of immune suppression and immune stimulation is being prepared for short and long term experiments. All EULEP laboratories working on carcinogenesis will be provided with suitable recommendations for their tumor models.

B. During the EULEP-meeting in November 1973, a reevaluation of the activities in the field of carcinogenesis within EULEP laboratories was started. The membership in the committee was redefined and includes people working on bone tumors, tumors of lung, breast, and bladder. A formal inventory was started by the chairman. It is planned to extend the work performed on a coordinated or collaborative basis to these tumor models and to the way by which they are induced.

Results of project N° 7

Head of the project : W. CALVO

Title of the project : COMMITTEE ON DYSPLASIA AND DYSTROPHIA
QUANTITATIVE AND QUALITATIVE CELL CHANGES

The project on "Late effects of irradiation on the CNS as a model for late vascular changes" was designed to elucidate the role of vascular alterations in the development of late effects in the brain, in particular with regard to the pathogenesis of "Late radionecrosis". It represents a cooperative effort of six laboratories, among which radiation exposure, animal care and determinations have been standardized. The project began in 1973 and so far the data up to 6 months after exposure have become available. Material for longer periods will be obtained in 1974.

Reinhold (Rijswijk) initiated a study on the functional capacity of the vascular system by means of fluorometry of the brain surface under different conditions of O₂ breathing. Pilot studies indicate that background fluorescence decreases as a result of irradiation. After correction for this phenomenon, it seems that a slightly hypoxic response remains from oxid/hypoxic determination of NAD/NADH fluorescence.

Hopewell (Oxford) in cooperation with Reinhold follows vascular architecture by histological methods and is now studying the initial groups of animals.

Keyeux (Louvain) investigates total and capillary blood-flow, total cephalic blood volume and the blood brain barrier permeability by means of the tracer curves of ⁹⁹Tc pertechnetate and ¹³¹I antipyrine. A total of 150 rats irradiated locally with 500-1000 R had already been analyzed and a new computer technique for the evaluation of the data has now been introduced for the EULEP program. First results indicate that the distribution of antipyrine in relation to pertechnetate is altered after irradiation.

Gerber (Mol) studies different biochemical parameters in the brain as well as uptake of amino acids by brain and other organs. Changes in DNA content, in sialic acid, lysosomal enzymes and serotonin were observed after irradiation. Amino acid uptake appears to be affected also in other organs (heart) after local exposure of the brain.

Maisin (Mol) studies the ultrastructural characteristics of the irradiated brain particularly the blood brain barrier on the dorsal race by means of electron microscopy. A total of 100 rats has been followed and changes have been found in the mitochondria and the Golgi apparatus which are interpreted as reflecting damage and repair.

Calvo (Ulm) investigates the incorporation of ^3H thymidine as an indicator of DNA synthesis in different cells of the brain using autoradiographic techniques in the same animals also studied in Mol.

A cooperative project on "Late biochemical effects in irradiated lung" was initiated between Danciewicz (Warsaw) and Gerber (Mol). The right rat lung was exposed to 2-3 kR of X rays, the others served as control. A decrease in lung weight and DNA content developed as fibrosis occurred. Simultaneously hydroxyproline, proteins and biogenic amines increased. Lysosomal enzymes showed a temporary activation. In 1974, these studies will be extended to cover also morphological aspects.

Results of project N° 8

Head of the project and coordinators : P.J. LINDOP

B.E. LAMBERT (Tritium and its compounds)

W.A. MULLER (Bone-seeking isotopes - EBONY)

Title of the project : POINT SOURCE EFFECTS COMMITTEE

Preamble

Preliminary work had collated data from those laboratories in EULEP engaged in internal radioisotope toxicity studies. These showed also the facilities available, and the flexibility of introducing coordinated projects in selected areas between two or more laboratories.

Subsequently projects developed to fulfill the EULEP principles, i.e. to coordinate on-going projects between laboratories ; in doing so, to develop methodology, and where necessary augment equipment or personnel to bring all laboratories to a comparable high standard and ultimately to design new cooperative experiments which could not be undertaken by a single laboratory.

The main work is divided into two groups, each with its own coordinator, one experienced in tritium toxicity studies and the other in toxicity of bone-seeking isotopes.

1. Tritium toxicity studies

So far two laboratories (Ulm and London) have coordinated their tritium toxicity studies in rats (Ulm) and mice (London). Such interchange visits of scientists and technical staff have shown the efficiency of direct contact for discussion, interchange of technical expertise, and standardization of optimum equipment, with only a small financial output. Thus, although each laboratory will continue to use different species (rats or mice), the techniques used have been standardized, to allow quantitative as well as qualitative intercomparisons of intracellular

dose and biological effects. During this year methods have been developed, and assessed for reproducibility, labelling efficiency, and possible cross-contamination of non-infused mice in the same room. Both subcutaneous and intraperitoneal infusions can now be given continuously to pregnant mice, so resulting in totally labelled offspring.

Most mice are being held for longterm studies, such as carcinogenesis. Acute serial sacrifice experiments have measured the turnover dynamics of the tritium label in DNA, and other biochemical fractions, from young mice following infusion, or repeated injection of the mother. Toxicity of intracellular tritium is being studied in the reproductive organs of these labelled mice. Techniques for quantitating cell death, and chromosome aberrations in spermatogonia and oocytes are being perfected with the aim of automating scoring techniques.

2. EBONY group studies

Following the first meeting of the group (April 1973), seven laboratories agreed on a cooperative project initially as an inter-comparison of the *in vivo* distribution of alpha or beta emitting bone-seekers administered to mice on an agreed protocol.

Three different nuclides are being compared on the basis of retention studies on C3H or C57 mice, female, 10-15 weeks old. These are supplied to the Institutes (Warsaw and Karlsruhe) who do not normally have these strains.

The nuclides are ^{223}Ra , 4 laboratories, coordinated at Neuharberg ; ^{239}Pu monomeric, 6 laboratories, coordinated at Harwell, and ^{90}Sr ^{90}Y , 4 laboratories, coordinated at Sunbyberg. Details of experimental procedures, such as supply, calibration, handling of injection solution, and measurement methods for the samples, as well as for dispatch of sample to alternate laboratories have been sent to the laboratories in August, so that the experiments began in September/October 1973, will cover up to 6 months follow up of retention data, when the group will reconvene, to discuss the implications of the inter-comparison for planning internal bone-seeking isotope toxicity experiments.

Conclusions

Each group has demonstrated the increased effectiveness at low cost of cooperative studies between laboratories in Europe, especially in complex fields where tackling each part of a problem separately may swamp a single laboratory in either capacity or enthusiasm. These initial projects create mutual interests by mutual education.

Moreover, they pinpoint novel problems which arise as common to all of the proposed studies. For example, the need to consider a different concept of radiation dosimetry in relation to point source irradiation, not yet covered by the "rad concept" nor the current microdosimetry field.

Results of project N° 9

Head of the project : P.J. LINDOP and P. METALLI

Title of the project : TEACHING PROGRAMME

As states in the original EULEP programme, Council laid stress on the importance of a continuous programme of mutual education, both on late effects research in principle, as well as on specialised topics, relevant to particular projects or working groups.

1973

The Dosimetry Intercomparison experiment was itself part of a technical training programme.

Similarly, the determination of LD 50/30 days for mice or rats under recorded if not standardised conditions, of which a discussion of the methods for analysing the results and their interpretation, was mutually informative, allowing both animal technologist-scientist as well as the animal user-scientist to understand the stringencies of the other sides requirements. The Animal Standardization Committee also held a 1-day review meeting of pathological conditions of relevance to late effects and lifespan studies.

A 2-day seminar, with invited speakers expert in the topic as well as in teaching, was successfully held at the Schloss Reisenburg, and attended by over 40 EULEP scientists and others becoming interested in Late Effect Studies.

A symposium on research organization and management was held in cooperation with the National Cancer Institutes, U.S., and E.O.R.T.C., intended to show the methodology of approach, e.g. in the cancer research or epidemiology fields, of possible use to a coordinated European programme.

The specialist publications resulting from Workshops organized by the Pathology Standardization Committee are important bases for future training programmes.

Contractor: International Commission on Radiological Protection

Contract No.: 91-73-1 BLOC.

Head of research team: C.G. Stewart, Chairman, ICRP.

General subject of contract: Development of fundamental data on radiation exposures and the establishment of recommendations regarding maximum permissible exposures.

Brief general description of the work carried out:

During 1973 ICRP continued its review of the fundamental principles on which appropriate radiation protection measures can be based. Resulting from this review, the Commission published three reports:

ICRP Publication 20: Alkaline Earth Metabolism in Adult Man.

ICRP Publication 21: Data for Protection against Ionizing Radiation from External Sources: Supplement to ICRP Publication 15.

ICRP Publication 22: Implications of Commission Recommendations that Doses be kept as Low as Readily Achievable.

ICRP also prepared a statement on trends in diagnostic radiology, which was submitted to the International Congress of Radiology and published in scientific journals (e.g. *British Journal of Radiology*, 1973, 46, 1086-1088).

The Commission and all its committees met in April to review work being performed by its committees and task groups. Representatives from a number of organisations, including EEC, were invited to attend the meeting.

ICRP task groups are currently working on the following topics:

Biological effects of inhaled radioactive particulates.
The balance between genetic effects in the first generation versus later generations.
The radiosensitivity of the embryo and foetus.
The influence of factors such as LET and protraction of exposure on genetic and somatic hazards.
The quantification of the severity of radiation effects for the purpose of estimating detriment.
Characteristics of the "Reference Man".
Dosimetry of radionuclides within the body (a revision of ICRP Publication 2).
The hazards of Radon, Thoron and their daughter products.
Respiratory absorption and elimination mechanisms.
Protection of the patient in radiotherapy.
A revision of ICRP Publication 5.
Emergency and accidental exposures.
Radiation protection in uranium mines.
Releases of radioactivity into the environment.

The following is the membership of the ICRP from 1973-77:

Main Commission

C.G. Stewart (Chairman)	A.C. Upton
B. Lindell (Vice-Chairman)	J. Vennart
D.J. Beninson	B. Windeyer
H. Jammet	
J. Liniecki	K.Z. Morgan
A.S. McLean	(Member Emeritus)
Y.I. Moskalev	L.S. Taylor
H.B. Newcombe	(Member Emeritus)
E.E. Pochin	
S. Takahashi	F.D. Sowby
	(Scientific Secretary)

Committee 1 on Radiation Effects

A.C. Upton (Chairman)	B. Modan
S. Abrahamson	R.H. Mole
G.W. Barendsen	G. Morlat
J.M. Brown	P. Oftedal
A.M. Brues	A.G. Searle
O. Hug	V. Zeleny

Committee 2 on Internal Exposure

J. Vennart (Chairman)	J. Lafuma
W.J. Bair	C. Mays
G.C. Butler	P.E. Morrow
G.W. Dolphin	P.V. Ramzaev
L.E. Feinendegen	W.S. Snyder
W. Jacobi	R.C. Thompson

Committee 3 on External Exposure

B. Lindell (Chairman)	R. Oliver
A. Kellerer	P. Pellerin
E.E. Kovalev	R.A. Rowley
L.-E. Larsson	K.A. Stevens
C. Meinhold	S. Takahashi

Committee 4 on Application of the Commission's Recommendations

H. Jammet (Chairman)	H. Muth
D.J. Beninson	C. Polvani
H.J. Dunster	L. Rogers
K. Koren	D.J. Stevens
E. Kunz	E.G. Struxness
D. Méchali	K. Sundaram
A.A. Moiseev	

GRUPPE BIOLOGIE ISPRA
KOMMISSION DER EUROPÄISCHEN GEMEINSCHAFTEN

BIOLOGY GROUP ISPRA
COMMISSION OF THE EUROPEAN COMMUNITIES

GROUPE DE BIOLOGIE ISPRA
COMMISSION DES COMMUNAUTÉS EUROPEENNES

BIOLOGY GROUP ISPRA - ITALY

Commission of the European Communities,
Directorate General for Research, Science
and Education - Biology Division

K.Gerbaulet

DIRECT PARTICIPATION OF THE COMMISSION
IN ITS ESTABLISHED PROGRAMME

GENERAL DESCRIPTION

The overall research work carried out during 1973 in close links with various Association or Group Contracts was mainly characterized by a continuation of approved activities allocated to this Group at Ispra. Its principal headings - comprising the projects undertaken - are:

1. Environmental contamination by radioactive and conventional pollutants.

Under this broad heading, specific aspects of the cycles of various radionuclides in the food chain as well as in terrestrial and aquatic systems were studied in contractual agreement with the Association EURATOM/CEA, whereas that part of the work referring to the "chromium" was carried out in a coordinated collaboration with the Association EURATOM/ITAL. The other studies, dealing especially with the effects of heavy metals, were a partial contribution to the Commission's established programme on "Protection of the Environment"; they were mainly performed on request and in close collaboration with the multidisciplinary Divisions of the Ispra Establishment of the Joint Research Centre.

In order to facilitate the view of the multiple studies undertaken an attempt was made to present their various results under the following sub-headings:

- Transfer of radionuclides in terrestrial systems.
- Transfer of radionuclides in aquatic systems.
- Influence of environmental factors.
- Chemico-biological interactions.

2. DNA damage by radiation and mutagenic chemicals. Mammalian mechanisms involved in the enzymatic expression and the repair of this damage.

The activity represents the continuation of a long-term research performed in the framework of the "Liaison Group on Genetic Effects of Radiation" sponsored by Euratom. Part of the work was a joint effort with the Laboratorio di Genetica Biochimica ed Evoluzionistica del CNR in Pavia, Italy, and with the Department of Molecular Genetics of the Leiden University at the Medisch Biological Laboratorium of TNO in Rijswijk, The Netherlands. The project is aiming to elucidate the direct biochemical consequences of the molecular lesions to the genetic material in mammalian cells. The experimental approach is centered on the biochemical specificity of the induced DNA injury and on the reactivity of the mammalian enzymes duplicating, repairing and translating the genetic information with the damaged macromolecule. The enzymes using DNA as a substrate or as a template are isolated from the thymus-lymphoid cell system and distinctively characterized with the aid of synthetic polydeoxynucleotides which mimic DNA of specific conformation and with given molecular alterations.

3. Radiation Biophysics and Microdosimetry.

These studies form part of an integrated programme on "Radiation dosimetry and the interpretation of radiation effects" in which 8 national institutes and the Commission participate (see reports of contracts in sector "Dosimetry"). They comprise two projects:

- Experimental studies and calculations on the radiation structure and W-values of low energy electrons, deuterons, and protons.
- Experiments and calculations of energy deposition patterns of X-rays, gamma-rays, and fast neutrons in critical volumes of biological interest.

4. Radiation sensitivity of insects.

As a partial contribution to the integrated programme on "Radioentomology" the studies were mainly concerned with specific physiological effects of gamma-irradiation to selected insect species belonging to the families of diptera, lepidoptera, hymenoptera and rynchota; they were principally carried out within a contractual collaboration with the University of Padova/Italy (105-BIOT).

Results of Project No.:1

Head of Project and Scientific Staff: K.Gerbault, M.F.Baudouin, A.Berg,
P.Guillot, E.Levi, M.Merlini, C.Myttenaere, O.Ravera, P.Reiniger,
P.Scoppa, W.Penning*, J.Y.Standaert*

Project Title: ENVIRONMENTAL CONTAMINATION BY RADIOACTIVE AND CONVENTIONAL
POLLUTANTS.

A. Transfer of radionuclides in terrestrial systems.

Direct contamination studies of rye and clover plants or mixtures of both species were made under greenhouse conditions to ascertain the retention of water, iodine and strontium when applied as solutions of different volumes in simulated rainfall experiments. Three densities of cultivation and 5 rates of simulated rainfall ranging from 1 to 15 mm/h were considered. Results available indicated that water retained by the plants immediately after treatment increased up to a 4 mm/h "rainfall" and remained constant thereafter. The iodine retained 24 h after application followed a similar curve but was consistently below that of water. Strontium on the other hand accumulated on the leaves more than water, was taken up, and, increased steadily in retention for clover, while for rye the total strontium retained did not increase any further as the "rainfall" was increased from 8 to 16 mm/h. The general results reported hold for all 3 densities considered but varied quantitatively. In the mixtures, at the time of treatment grassleaf cover was predominant, yet each species showed the same tendency as when cultivated alone.

The retention of rainwater was determined additionally by measuring the soil moisture by gamma-ray attenuation. For this purpose a scanner had been constructed permitting - under greenhouse conditions with widely fluctuating temperatures - such measurements in pots containing the growing plants.

Experiments made under controlled environmental conditions aimed at determining the possible antagonism shown in the retention, adsorption, absorption and subsequent movement following application to bean leaves of Cs-137 when applied in solutions containing Zn⁺⁺. No evident effect was found to modify the normal uptake and distribution of Cs⁺ when the Zn⁺⁺ concentration in the solution was smaller than 10⁻³ M. At this and higher

* Post-graduate students.

concentrations, the total Cs taken up was decreased and its normal distribution in the plant slowed down. It was ascertained that the effect was not due to the presence of the radioactive tracer of Zn.

Studies of the metabolism of Cr-51 following root uptake were continued in rice plants; they aimed at determining the localisation of Cr-51 as function of its chemical form, of its concentration and of the time of exposure; one month old plants were used for these experiments. Determinations of the localisation revealed that the main part of Cr-51 was bound to the pectic material; its fixation was very rapid and its relative distribution did not change from 15 min to 14 days exposure time. At low concentration (0.01 ppm), CrO_4^{--} was more rapidly absorbed during the first 6 hours but the inverse relation was obtained for longer periods; at 0.1 ppm a clear decrease of CrO_4^{--} absorption was observed. Since the relative distribution obtained was similar whether applying Cr-51 as Cr^{+++} or CrO_4^{--} the validity of the "reduction hypothesis" (reduction of Cr^{6+} to Cr^{3+} at root surface) seems to be confirmed.

The transfer of Zn-65 and Cd-109 from water to rice was studied in irrigated rice field models. The irrigation water, daily traced with the radio-nuclides, contained the corresponding stable elements in their maximum permissible concentrations of 0.5 ppm Zn and 0.005 ppm Cd. An analysis of the different compartment of such an ecosystem showed that more than 70% of Cd and Zn were fixed by the soil. Plant relative distribution was quite similar for both elements; roots percentage was slightly higher for Cd (+ 50%); caryopsis contained + 3% of plant total activity. Under the experimental conditions, the mean concentration factor between water and endosperm was clearly higher for Cd (150 against 8 for Zn).

The experiments on the "fixation" of chromium in soil were continued on a podzol and extended to a peat soil. Sodium chromate marked with Cr-51 was "fixed" in the peat soil to almost 100% after a contact time of 24 hours, compared with 80% in a podzol and 40% in a alkaline river clay soil. Besides pH and the redox potential the organic matter content of the soil could be shown to be largely responsible for the "fixation" of chromate. After removal of the organic matter by treatment with H_2O_2 , a podzol after a contact time of 24 hours "fixed" only 20% of the sodium chromate added compared with 80% in the original soil. Raising the pH to 8.3 after the removal of organic matter reduced chromate "fixation" to zero. Trivalent Cr-51 added in the form of CrCl_3 to a peat soil was fixed to almost 100% in one hour of contact.

B. Transfer of radioisotopes in aquatic systems.

Uptake from water and accumulation of Hg-203, Cd-109, Zn-65 and Pb-203 by freshwater zooplankton is under investigation at water temperatures of 10° and 15°C. The following values of the factors of transfer were calculated from preliminary experiments: Eudiaptomus padanus: 1250 (10°C) - 1400 (15°C) for Hg, 360 - 420 for Cd, 88 - 103 for Zn, 380 - 380 for Pb. Cyclops abyssorum: 1800 (10°C) - 1850 (15°C) for Hg, 120 - 120 for Zn, 375 - 400 for Pb. Daphnia hyalina: 200 (10°C) - 220 (15°C) for Hg, 80 - 80 for Zn. These data show that temperature changes have only negligible effects on the accumulation of radionuclides by the zooplankton, although uptake rate may be higher when temperature is increased.

Experiments on uptake, accumulation and retention of Cr-51 by freshwater zooplankton were continued. Uptake of trivalent Cr-51 by Daphnia hyalina, Cyclops abyssorum, and Eudiaptomus padanus was rapid: the concentration of the radionuclide in the animals exceeded that in the water in less than 30 min. At the end of the 16 hr observation (radioactivity ratios: 36.8 for Daphnia, 12.0 for Cyclops, and 73.9 for Eudiaptomus), the accumulation took place at a very slow rate showing that equilibrium conditions were still far to be reached. An increase of 5°C in water temperature resulted in higher uptake rate and accumulation. The most part of Cr-51 was very weakly bound and therefore had a rapid turnover rate. In contrast to the results obtained with trivalent Cr-51, both copepods did not accumulate hexavalent Cr to a considerable extent, whereas the cladoceran Daphnia showed a ratio of radioactivity of 19.6. An increase of 5°C in water temperature resulted in minimal changes in the cases of Cyclops and Eudiaptomus: in Daphnia uptake rate was strongly increased and accumulation was almost doubled.

Preceding studies on the accumulation of radio-chromium by freshwater fish have been completed: it was found that accumulation reached a maximum already after 4-6 days and that its level, mostly due to adsorption, varied considerably with time and between the individuals. The accumulated radio-chromium was distributed rather homogeneously in the whole body without evidence of "hot spots" and with only slight differences between Cr³⁺ and Cr⁶⁺; its excretion was very rapid and brought contamination down to a negligible level after a few days.

Studies on specific aspects of Zn-65 accumulation and excretion by freshwater fish were pursued. Experiments showed that an eventual ingestion of contaminated water could not be taken into account to explain the important

role intestine is playing in the excretion of previously absorbed Zn-65. Direct accumulation was stimulated by about 25% through administration of a composite diet (trout pellets) relative to a synthetic one. In another experiment of direct accumulation (from water), the specific radioactivity of the organs after 6 days was very low relative to that of water (1-3%). This clearly indicates that the level of accumulation at equilibrium cannot be estimated from a short term experiment in a stationary state. Therefore, a long term experiment was performed on two fish species reared in growing conditions (Carassius auratus 3 g and Pelmotochromis subocellatus 0.15 g). Levels of accumulation were found to be much greater than those obtained previously (concentration factors relative to water respectively equal to 640 and 2810), with maximal differences of the order of 50 to 600 times. This shows the importance of a correct extrapolation of experimental data to environmental conditions.

For indirect accumulation studies in fish, zooplankton (Eudiaptomus padanus) was traced in vivo with Zn-65, then dried and fed to Lebistes reticulatus for 51 days. Preliminary results showed that less than 1% of the activity eaten in 51 days was retained by the fish. An observed activity in the water was found to originate from food and feces (filtered and counted, 52%) as well as from what these parts lost to the water or what was eliminated by the fish through the skin and gills (47%). After 32 days of eating nonactive plankton, the fish lost about half of the activity accumulated in 51 days eating radioactive food.

C. Influence of environmental factors.

Uptake from water, accumulation and toxicity of radionuclides and stable elements are dependent on multiple environmental factors. A first attempt was made to elucidate the influence of water physico-chemical characteristics on these processes:

An ion association model was used to estimate interactions between some heavy metals and the major anions present in freshwater. The percent distribution of the chemical species of copper, zinc, cadmium, and lead in 16 lakes of Northern Italy was calculate in the pH range from 6 to 9. These calculations showed that the metals examined can be complexed to a considerable extent and that the distribution of the chemical species of each metal varies greatly with changes of pH and water composition.

Previous toxicity experiments were continued by a large scale experiment

to evaluate joint toxicity, i.e. the toxicity resulting from simultaneous exposure to more than one toxic agent. A recent method to predict joint toxicity was used to test the 15 possible combinations of 6 heavy metals (Hg, Zn, Ni, Cd, Cu, Cr) in equitoxic concentrations. A computer program for evaluation of statistical significance of antagonistic or synergistic effects was prepared. The analysis of experimental results showed additive effects for all the combinations tested. The only exception were the combinations containing chromate, which gave rise to synergistic effects in Daphnia hyalina.

The effect of water temperature on the toxicity of Ni, Cu, Hg, Pb, Zn, and chromate was studied in Eudiaptomus padanus. Median lethal concentrations for Ni and chromate did not change to a significant extent when water temperature was 10, 15, or 20°C. Significant increases in the toxicity of Cu, Zn, and Hg occurred when water temperature was raised from 10 to 20°C. An increase of 5°C was sufficient to enhance the toxic effect of Pb.

Preliminary experiments to assess the effect of water pH on the toxicity of Cu, Zn, Cd, Pb, and chromate to Eudiaptomus padanus showed faster uptake kinetics and increased toxicity when the pH was changed from 7.5 to 6.5. These results are in good agreement with the calculated distributions of the free metal ions and the hydrochromate anion.

D. Chemico-biological interactions.

A number of hydrogen ion buffers commonly used in biochemical studies complex or precipitate most polyvalent cations. The interactions of the amine 2-amino-2(hydroxymethyl)-1,3-propanediol (Tris) with several divalent metal ions were investigated by potentiometric titrations and the use of ion specific electrodes. The results obtained indicate that the use of this buffer should be avoided in studies directed to evaluate possible effects of heavy metals on chemical or enzymatic reactions.

The influence of divalent cations on hepatic microsomal drug metabolism was studied "in vitro". Two enzymatic reactions representative of the mixed function oxidase system were taken into consideration: the N-demethylation of aminopyrine (a type I binding substrate) and the p-hydroxylation of aniline (a type II binding substrate). Relatively high concentrations (10 mM) of most metals were required to modify drug metabolizing activities. Addition of Mg, Ca, Sr, or Mn resulted in stimulation of enzyme activities. Moderate inhibition was observed in the presence of Fe, Cu, Co, Zn, or Pb.

Two metals of the IIB subgroup of the periodic table of the elements, Cd and Hg, were powerful inhibitors. Aminopyrine N-demethylation was 50% inhibited in the presence of 0.12 mM CdCl₂ or 0.033 mM HgCl₂. Aniline p-hydroxylation was inhibited by the same extent when 0.07 mM CdCl₂ or 0.029 mM HgCl₂ were added to the incubation mixtures. The possibility that these metals could have an indirect mechanism of action, by inhibiting the enzymatic regeneration of NADPH, was ruled out after experiments with chemically reduced NADPH. The effects of Cd and Hg were compared with the capacity of microsomal proteins to bind such metal ions. Mercury is irreversibly bound, but cadmium can be removed by exhaustive dialysis. These data will be examined on the basis of hepatic subcellular distribution of Cd and Hg in rats treated with metal compounds.

Studies on the mechanisms by which lead impairs the metabolism of xenobiotics "in vivo" were continued. The hypothesis that hepatic cytochrome P-450 level was reduced as a consequence of delta-ALA dehydrase inhibition was discarded. Incorporation of labelled delta-ALA into microsomal CO-binding pigments (mainly P-450 and related cytochromes) was only slightly delayed in lead poisoned rats. However, cytochrome P-450 degradation occurred at a much faster rate. The fast phase component had a half-life of 8 hours in controls compared to approximately 4 hours in treated animals. The half-life of the slow phase component was also significantly reduced in lead poisoned rats. Further studies are in progress to investigate possible effects of lead on the regulation of delta-ALA synthetase.

List of Publications

- 1) M.F.Baudouin, P.Scoppa : "Calculated distribution of the chemical species of copper, zinc, cadmium and lead in 16 lakes of Northern Italy". Euratom Report EUR-5052e (1974).
- 2) M.F.Baudouin, A.Lepers, F.Bonsignore Di Nozzi, P.Scoppa: "Metodi per la determinazione del consumo di ossigeno da parte degli organismi zooplanc-tonici". Bollettino Società Italiana Biologia Sperimentale, 49S, 69(1973).
- 3) M.F.Baudouin, P.Scoppa: "Nucleic acid determination in freshwater plankton: its ecological implications". Freshwater Biology (in press).

- 4) M.F.Baudouin, P.Scoppa: "Acute toxicity of various metals to freshwater zooplankton".
Bulletin Environmental Contamination and Toxicology (submitted for publication).
- 5) M.F.Baudouin, P.Scoppa: "A program for the chemical speciation of copper, cadmium and lead in freshwater".
Bulletin HP-20 Calculator Users Club, Log. No. 0265, 1973.
- 6) A.Berg and al.: "Ricerche della Divisione di Biologia Euratom nel campo della radioecologia".
Convegno Radioecologia, Parma, 24-25/5/1973.
- 7) A.Berg, A.Brazzelli: "Etude expérimentale du transfert du Zn-65 à un poisson d'eau douce, avec référence particulière aux deux voies d'absorption et au métabolisme de l'élément stable (submitted for publication)".
- 8) E.Levi, X.Dalschaert, J.B.M. Wilmer: "Retention and absorption of foliar applied Cr".
Plant and Soil, 38(3), 683-686 (1973).
- 9) C.Myttenaere, J.M.Mousny: "The distribution of chromium-51 in lowland rice in relation to the chemical form and to the amount of stable chromium in the nutrient solution".
Plant and Soil (in press).
- 10) C.Myttenaere, J.M.Mousny: "Localisation and translocation of chromium in relation to its chemical form and level".
(ESNA, Nuclear technique in the study of soil - plant relation),
Varsovie, 1973.
- 11) C.Myttenaere, P.Guillot, J.M.Mousny: " Radiocesium retention in tomato plants (Lycopersicum esculentum) as a function of the stable and radioactive Cs-137 concentration of the nutrient mediums".
Rad. Botany (in press).
- 12) C.Myttenaere: "Isotopic discrimination; Trans. 3rd Symp. on accumulation and translocation of nutrients and regulators in plant organisms, Warszawa, 14-18 May 1973".
Proc. Inst. of Pomology; serie E, 3(1973).

- 13) O.Ravera: "L'inquinamento delle acque lombarde".
Unità Sanitaria, No. 3: 24-25 (1973).
- 14) O.Ravera, A.Cartisano, R.De Bernardi, L.Guzzi: "Effects of chelating agents (EDTA and SNTA) on the incorporation of radionuclides by freshwater filter feeding organisms (Copepods and Lamellibranch)".
Atti 5° Coll. Int. Oceanogr. Med., Messina, 437-448 (1973).
- 15) P.Reiniger, E.Levi, M.Coppola: "Measurement of surface water on ryegrass and clover by nuclear methods".
IAEA/SM-176/11 - Symposium on Isotopes and Radiation Techniques in Studies of Soil Physics, Irrigation and Drainage in Relation to Crop Production. IAEA/FAO, Vienna, 1-5 October 1973.
- 16) P.Scoppa, W.Penning: "Interazione del piombo con il tampone tris in soluzione diluita".
Bollettino Società Italiana Biologia Sperimentale, 49S, 67(1973).
- 17) P.Scoppa, M.Roumengous, W.Penning: "Hepatic drug metabolizing activity in lead-poisoned rats".
Experientia, 29, 970-973 (1973).
- 18) P.Scoppa, M.Roumengous: "Effetto di alcuni ioni metallici sulle attività enzimatiche farmaco-metaboliche".
Bollettino Società Italiana Biologia Sperimentale, 49S, 66 (1973).
- 19) P.Scoppa: "Il ruolo della metallotioneina nell'accumulo di cadmio da parte dei mammiferi e dei pesci".
Atti del Simposio "Oligoelementi e Nutrizione", Bologna, 1973.
- 20) P.Scoppa, M.F.Baudouin: "Interactions in the acute toxicity of chemicals".
Bulletin HP-20 Calculator Users Club (submitted for publication).
- 21) J.Y. Standaert, C.Myttenaere, J.A. Meyer: "Influence of sodium/calcium ratios and ionic strength of the nutrient solution on Fusarium wilt of tomato".
Plant Science Letters, 1, 413-20 (1973).

Results of Project No.: 2

Head of Project and Scientific Staff: F.Campagnari, L.Clerici, M.Talpaert,
M.Mathelet *

Project Title: DNA DAMAGE BY RADIATION AND MUTAGENIC CHEMICALS. MAMMALIAN
MECHANISMS PRIMARILY INVOLVED IN THE ENZYMATIC EXPRESSION
AND THE REPAIR OF THIS DAMAGE.

Methods of analysis of nucleic acids.

A homogeneous viral DNA of known molecular weight was used to establish the limits of sensitivity and of resolution in the measurements of molecular weight of nucleic acids by end-phosphate analysis. Using 625 μg of intact bihelical DNA from the SPP1 phage of *B. subtilis* as a reference sample, chain lengths of 3.6×10^4 nucleotides corresponding to a molecular weight of 2.4×10^7 daltons in a double stranded DNA were successfully estimated with the same experimental error exhibited by the conventional ultracentrifugal determinations. The procedure may well be adapted to DNA samples with a molecular mass of 10^8 daltons per end-phosphate group. These additional data served to confirm definitely the experimental basis of the absolute analytical method which allowed to prove valid the formula proposed previously for calculating the number-average molecular weight of heterogeneous DNA populations from band sedimentation measurements. These new results were included in the paper announced in the 1972 Report and appeared in a final enlarged version in the 1973 volume of Biochemistry.

Enzymatic methods for the precise counting of the chemical termini present in the strand breaks of X-irradiated DNA and required by DNA ligase for the repair of the chain interruptions of DNA were modified and improved. The current determination of the 5'-OH and 5'-PO₄ terminal groups by coupling the action of polynucleotide kinase and alkaline phosphatase was found to yield substantially lower figures than the total number of 5'-functional groups. Moreover, a specific exonuclease must be used in combination with terminal transferase and alkaline phosphatase in order to ascertain quantitatively the exact amounts of 3'-OH and 3'-PO₄ end groups in DNA.

*Post-graduate student.

Preparation and use of polynucleotides.

The synthesis of polydeoxynucleotides and the assembling of DNA-like models as requested by the Euratom associated laboratories was continued. A new set of "initiated polyribonucleotide and polydeoxyribonucleotide templates" was prepared. The polymers were used as differential primers for detecting DNA polymerases with various template specificities.

Purification and characterization of nucleic acid enzymes.

A new method for the purification of nuclei from the mammalian cells has been devised. The nuclear fraction was isolated in good yield and with high purity from the other subcellular organelles by centrifugation of the tissue homogenates through a discontinuous glycerol gradient. From these nuclei, DNA-dependent RNA polymerase A and DNA polymerase of 3.39 sedimentation coefficient were partially purified with satisfactory results. As combined with previously standardized methods, the new procedures allowed the concomitant preparation of the four main DNA polymerases present in calf thymus cells. The two cytoplasmic deoxynucleotidyl transferases (the terminal enzyme and the 6-8 S DNA polymerase described by Bollum), as well as the 3.39 S DNA polymerase of Chang and Bollum and the 70,000 mol. weight DNA polymerase isolated in our laboratory from the nuclear fraction, were characterized distinctively and shown to be separate catalytic proteins.

Radiation effects on DNA.

It was found that breaks caused in the strands of DNA in solution by low doses of X-rays can be ascribed to two types of lesions. First, the actual scission of the sugar-phosphate backbone of the polymer. Second, labilized DNA structures which may result in strand interruptions when the DNA solution was kept at an alkaline pH for a long time. Chain breaks were observed also in non-irradiated DNA following an alkali treatment. Taking into account these findings and the resources of the available methodology, specific experiments were devised to measure the maximal production of strand breaks in calf thymus DNA irradiated in 10^{-2} M NaCl or equivalent inorganic salts. It was found that 250 kv X-rays delivered at 10 mA through a copper filter of 1 mm induced 1.2 single strand breaks per 10^6 daltons per 10^3 rads. The initial production of double strand scissions was 22 times lower. Of the newly formed termini at the 5' side in the breaks, only 3% carried hydroxyl groups while about 70% reacted as phosphate groups. The alkali labile DNA structures yielding secondarily strand breaks in irradiated DNA

were from 6 to 9 times more numerous than the actual chain scissions.

Repairing enzymes.

About 25% of the monohelical breaks induced to DNA in aqueous solution by a single dose of 1,500 rads were repaired by purified mammalian DNA ligase. The enzyme, devoid of detectable nuclease contamination, exhibited less specificity than expected. In fact, not all the sealed DNA interruptions carried juxtaposed 5'-PO₄ and 3'-OH termini and were free from base damage in the adjacent nucleotidyl residues.

List of Publications

- 1) F.Campagnari, M.Mathelet, L.Clerici : "The repair of the breaks in the X-irradiated DNA by the polynucleotide ligase from mammalian sources". Commun. Workshop on Repair Mechanisms in Mammalian Cells, Noordwijkerhout, May 6-10, 1973, Book of Abstracts, Session 3, page 2.
- 2) L.Clerici, E.Sabbioni, F.Campagnari, S.Spadari, F.Girardi : "Determination of the molecular weight in nucleic acids by end-phosphate analysis". Biochemistry, 12, 2887-2891 (1973).
- 3) G.P.van der Schans, F.Campagnari : "Distribution of molecular weight and sedimentation coefficient in zone centrifugation of DNA samples with molecules of random chain length." Biochemistry, 12, 2891-2893 (1973).
- 4) E.Sabbioni, L.Clerici, F.Girardi, F.Campagnari : "Non-destructive analysis of phosphorus by neutron activation analysis in biochemical products". J. Radioanalytical Chemistry, 14, 159-169 (1973).

Results of Project No.: 3

Head of Project and Scientific Staff: J.Booz, M.Coppola, U.Borst*, R.Eickel*,
H.Menzel*, A.Waker*

Project Title: RADIATION STRUCTURE OF IONIZING RADIATIONS IN TISSUE AND
ITS RELATION TO THEIR SPECTRAL ENERGY DEPOSITION IN BIOLOG-
ICAL STRUCTURES AND TO THE BIOLOGICAL EFFECTIVENESS.

A. Radiation structure in biological material and in model substances.

The apparatus for the measurement of the ionization yield (W-values), transmission, range-energy relationship, and local distribution of ionization around a pencil beam of monoenergetic electrons with a primary energy of ≤ 5 keV has been completed. The measurements are to be carried out in various gases of interest in microdosimetry such as tissue equivalent gas, CH₄, CO₂, air, etc.

The electron source consists of a Steigerwalt type self focusing cathode which gives a converging beam of relatively high emission. The accelerating system has been constructed in such a way that for primary energies below 1 keV it is possible to extract the electrons at a high potential and slow them down to the required immediately before the collimator.

The energy distribution of the primary electrons has been measured by the retarding field technique and was found to have a F.W.H.M. of 6% at 20 eV and 2% at 2 keV. The intensity of the beam can be controlled between 10^{-12} A to 10^{-9} A.

A differential pumping system maintains the filament of the gun at 10^{-6} torr and the scatter chamber up to a pressure of 10 torr.

First results have been obtained for the W-value of electrons in methane. The W-value increases continuously with decreasing energy between 5 keV and 30 eV, the differential W-value being nearly constant above 100 eV.

The experiments on the radiation structure of protons and deuterons of 500 keV to 3 MeV in tissue equivalent gas have been terminated. The results that will deliver information on the dose profile around charged particles and on the energy transport by delta-rays in tissue are being evaluated.

* Post-graduate students.

B. Evaluation of the energy deposition of different types of radiations to small biological volumes and its relation to the corresponding biological effectiveness.

The studies are dealing with 200 KV X-rays, gamma-rays of Co^{60} , and fast neutrons.

Final experimental results have been obtained for the spectral energy deposition of 200 KV X-rays and Co^{60} gamma-rays in spherical volumes of 0.3 to 1.5 μm mean diameter using a 2" Rossi-counter. Fig. 1 shows some measured spectra for 200 KV X-rays.

First results have also been obtained with the cylindrical wallless counter the set up of which has been completed recently. The counter is bounded by a cylindrical grid with an optical transmission of 93% and housed in a metal vacuum chamber with entrance and exit windows for the radiations. The studies with this counter showed that lower mean diameters could be obtained than with the 2" Rossi-counter. Measurements were done at mean diameters of 0.1 to 3 μm for both radiations.

It is planned to compare the final experimental results with Monte Carlo-calculations and to study the possibility of extrapolation to very small volume sizes where experimental determination are no longer possible. The input data for the calculation has been completed.

The studies on the influence of the counter wall on the energy deposition of fast neutrons to spherical volumes have been continued. The results of the effect of proton and alpha-particle energy straggling were extended to other energies, while completely new results were obtained for the neutron multiple scattering in the counter wall. For these calculations the computing programme ENSPHERE was thoroughly revised and expanded to yield new relevant information. The results showed that the two mentioned effects influence indeed the energy distributions and, therefore, must be properly considered for the interpretations of the experimental results and in the application of simulation procedures to real cases. Fig. 2 shows an example of the influence of multiple neutron scattering.

When radiobiological effects are compared to microdosimetric results generally the flux averaged energy deposition, $\bar{\epsilon}_p$, and the dose averaged energy deposition, $\bar{\epsilon}_D$, are regarded as the significant parameters. These two quantities can easily be calculated from existing energy deposition spectra. However, as the determination of such neutron energy deposition spectra is difficult an attempt was made to find simplified mathematical

expressions for these two quantities. This study was based on an analysis of the event probability and the mean energy deposition of the single recoil ions done with the help of a modified version of the program ENSPHERE for neutron energies of 50 keV to 6 MeV and for a volume size of 1 μm . The values of \bar{E}_F and \bar{E}_D calculated with the found simplified expressions agree roughly with the more accurate Monte Carlo-results. The expressions for \bar{E}_F and \bar{E}_D are expected to hold also for spheres of any other size when some necessary modifications are introduced.

From the experimental point of view, the knowledge of the neutron dose and the neutron energy spectrum at the point of the measurement is an information of primary importance for microdosimetric studies. Therefore, a special type of proton recoil gas telescope counter was constructed, useful in a wide range of neutron energies. The main principle consists of using a fast coincidence technique to achieve, through discrimination of proton track directions, the necessary selection of maximum recoil energies. The measurements done recently with this spectrometer have proved the ability of the chosen technique to yield discrete neutron energy distributions from few hundred keV to several MeV. Fig. 3 shows an example of a measured energy spectrum of a nearly monoenergetic neutron beam. An ionization chamber dosimeter, a He^3 -spectrometer, and a BF_3 long counter have been assembled and will be used as routine instruments for the fast neutron experiments and irradiations.

A new study on the dose distribution in human thyroids due to therapeutic and accidental iodine uptake has been initiated in collaboration with the Association Euratom - CEA, Paris and with the Radioisotopes Service, Hospital St. Pierre, Brussels.

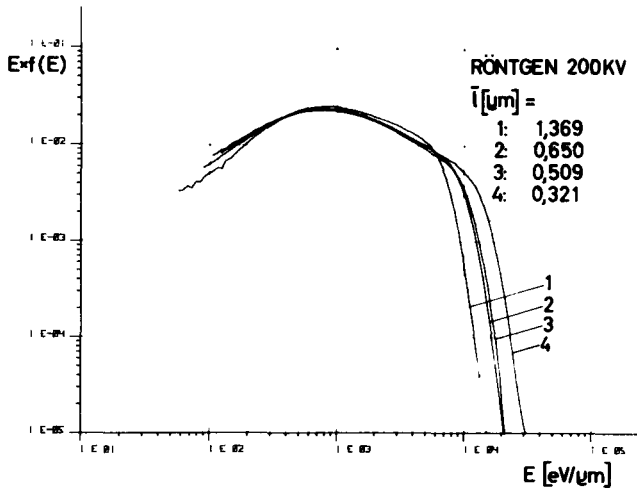

Fig. 1 : Spectral energy deposition of 200 KV x-rays to spheres of various mean pathlengths.

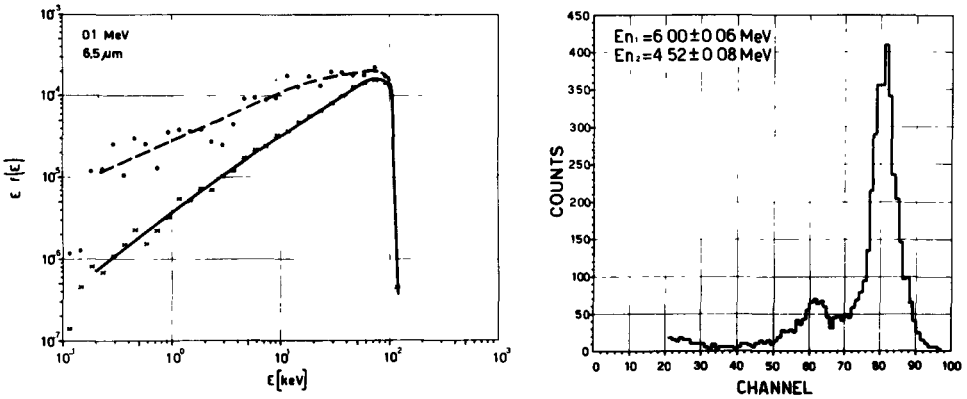

Fig. 2 : Spectral energy deposition of 0.1 MeV neutrons to spheres of 6.5 μm diameter. Comparison of calculated spectra without multiple neutron scattering (solid line) and with multiple scattering (dashed line).

Fig. 3 : Measured spectrum corresponding to neutrons from the $\text{D}(d,n) \text{He}^3$ reaction. The small peak of 4.52 MeV neutrons is due to a contamination of the deuteron-beam with D_2 -molecules.

List of Publications

- 1) M.Coppola, J.Booz : "Influence of Energy Straggling on the Shape of Neutron-Produced Single Event Spectra", Biophysik 9, 225 (1973).
- 2) J.Booz, U.Oldenburger, M.Coppola: "Das Problem der Gewebeäquivalenz für schnelle Neutronen in der Mikrodosimetrie".
Proc. First Symp. Neutron Dosimetry, EUR 4896 (1973).
- 3) J.Booz, M.Coppola: "Energy Deposition by Fast Neutrons to Small Spheres".
Proc. Fourth Symp. Microdosimetry, EUR 5122 (1974),
- 4) M.Coppola, D.Pirrwitz, J. Booz: "Influence of Detector Size and Thickness on Neutron Produced Energy Deposition Spectra".
Proc. Fourth Symp. Microdosimetry, EUR 5122 (1974).
- 5) H.Borst, M.Coppola, J. Booz: "Measurement of Fast Neutron Spectra with a Proton Recoil Spectrometer".
Proc. Fourth Symp. Microdosimetry, EUR 5122 (1974),
- 6) J.Booz: "Energy Deposition on a Microscopic Scale, Relevant to the Biological Effects of Fast Neutrons".
Proc. Symp. Effects Neutron Irrad. Cell Function (in press).

Results of Project No.: 4

Head of Project and Scientific Staff: R.Cavalloro, G.Delrio

Project Title : RADIATION SENSITIVITY OF INSECTS.

Studies of the physiological effects of gamma-irradiation to various insect species - belonging to the families of diptera, lepidoptera, hymenoptera and rynchota - were initiated or continued in a close collaboration with the University of Padova. In all these studies the irradiation was performed at different stages of life-cycle and applied to eggs, larvae, chrysalis or pupae, and adults; the examinations considered: lethal dosis for the single stages, induction of lethal dominant mutations, alterations in the duration of the single steps of life-cycle, changes in spermatogenesis and fertility, and influences of the sexual behaviour.

- Diptera: In Dacus oleae (Gmel.), intensively studied during the previous years, that radiation dose which produced the relative highest number of sterile and competitive spermatozoa without reducing the virility of the males was determined to be 12 krad when irradiating the newly emerged adults or 7 krad when irradiating the pupae three days before adult emergence. The resulting higher efficiency of an application of sub-sterilizing doses for practical purposes could be confirmed for Ceratitis capitata (Wied.) also theoretically by a simulation model in which the relative frequency of egg-hatching in relation to the applied radiation doses was calculated for various ratios of irradiated males to normal pairs.

- Lepidoptera: Irradiation experiments with particular attention to lethal and the sterilizing doses were completed in Epichoristodes acerbella (Walk.) as well as Cacoecimorpha pronubana (Hüb.); furthermore, an artificial and economic diet was established for rearing the larvae of Sesamia nonagrioides (Lef.) under laboratory conditions.

- Hymenoptera: Relative low irradiation doses up to 10 krad were found to increase significantly the longevity of Opius concolor (Szép), a parasite of the olive fly, whereas doses exceeding this level decreased progressively the mean survival time; a reduction to one-half of the ST_{50} required doses of about 50 krad.

- Rynchota: Studies of the sensitivity to gamma-irradiation were initiated in Gonocerus acuteangulatus (Goeze). Preliminary results revealed that

doses exceeding 8 krad inhibited already the mating capability of males whereas females continued even after 4-fold higher doses; the relative number of induced lethal dominant mutations was only 19.3% after a dose of 8 krad, but in the F_1 -generation an "inherited sterility" became evident in more than 90% of the hatched adults whether males or females.

List of Publications

- 1) R.Cavalloro, A.Piana: "Prove di radiosensibilità alle radiazioni ionizzanti dei tortricidi del garofano, con particolare riguardo ad Epichoristodes acerbella (walker)".
Redia, Firenze, LIII, 281-302 (1973).
- 2) R.Cavalloro, Ph.Ruelle: "Contenu en acides amines libres des larves et adultes de la mouche de l'olive (Dacus oleae)".
Annales de la Société entomologique de France, Paris, 9(1), 141-146 (1973).
- 3) R.Prota, R.Cavalloro: "Osservazioni sul comportamento di Sesamia nonagrioides (Lef.) (Lepidoptera, Noctuidae) allo scopo di condurre allevamenti massivi in laboratorio".
Studi Sassaesi, sez. III, Annali della Facoltà di Agraria, Sassari, XXI, 1-22 (1973).
- 4) R.Cavalloro, R.Prota: "Metodo di allevamento di Sesamia nonagrioides (Lef.) (Lepidoptera, Noctuidae) con diete artificiali".
Redia, Firenze, LIII, 395-411 (1973).
- 5) R.Cavalloro, G.Delrio: "Mating behavior and competitiveness of gamma-irradiated olive fruit flies".
Journal of Economic Entomology (in press).
- 6) S.Zangheri, R.Cavalloro, L.Masutti, V.Girolami: "Nuovi orientamenti nella lotta contro il Dacus oleae Gmelin: saggi preliminari e prospettive di studio biologico e demoeologico nell'Italia settentrionale".
Redia (in press).
- 7) R.Cavalloro, G.Delrio: "Incremento della fertilità delle uova di Dacus oleae Gmelin negli allevamenti permanenti".
Note ed Appunti Sperimentali di Entomologia Applicata (in press).
- 8) V.Girolami, R.Cavalloro: "Metodi cromotropici per indagini di popolazione degli adulti di Dacus oleae Gmelin".
Note ed Appunti Sperimentali di Entomologia Applicata (in press).
- 9) R.Cavalloro, G.Delrio: "La radiosterilizzazione di Dacus oleae Gmelin e prospettive di lotta mediante la tecnica del maschio sterile".
Redia (in press).
- 10) R.Cavalloro, G.Delrio, L.Anselmi: "Criterio di stima dell'efficacia di maschi sterili e substerili nella lotta contro gli insetti, con particolare riferimento a Ceratitis capitata Wiedemann".
Note ed Appunti Sperimentali di Entomologia Applicata (in press).

IV.

FORSCHUNGSTÄTIGKEIT ANWENDUNGEN LANDWIRTSCHAFT

RESEARCH ON APPLICATIONS IN AGRICULTURE

RECHERCHES RELATIVES AUX APPLICATIONS AGRONOMIQUES

ITAL UND UNTERVERTRÄGE

ITAL AND ITS SUBCONTRACTS

ITAL ET SOUS-CONTRATS

Contractant van de Commissie: Institute of the Association EURATOM-ITAL, Wageningen, the Netherlands.

Nummer van het contract: 094/72/1 BIAN

Hoofd van de groepen voor onderzoek: Dr. Ir. D. de Zeeuw.

Algemeen onderwerp van het contract:

APPLICATIONS OF NUCLEAR METHODS IN AGRICULTURE AND BIOLOGY

- movement of national chemical elements and pollutants through soils.
- uptake, transport, accumulation, redistribution of mineral elements in plants.
- mutation breeding, incompatibility, mutagenesis.
- food irradiation.
- genetic control of insect pests.
- development of nuclear methods for agricultural, environmental and plant-biological research.

Algemene omschrijving van de uitgevoerde werkzaamheden:

In the soils and plant part of the 1973-programme, the following aspects were studied:

- extensive investigation of the literature on microbiological aspects and on the value of several existing mathematical simulation models on nitrogen behaviour in soils.
- Information was obtained on the role of nitrogen fixing blue-green algae in the eutrophication process: species in dutch natural waters; interaction nitrogen/chemical form of available phosphates; possibility to use growth of blue-green algae as a bio-assay for phosphate levels in the medium.
- Further data became available on the absorption properties and the movement in soil of the insecticide Trichloronate and of herbicide BAM. Mathematical simulation models, considering instantaneous and non-instantaneous equilibrium, convection, diffusion and hydrodynamic effects were worked out and, to a certain extent, compared with experimental results for both compounds.
- Progress was made with respect to the development of a suitable solid synthetic growth medium, which better approaches the normal root environment in soils. Plant growth, root development, ion exchange between the medium and roots were studied for several plant species. Parameters for the mathematical simulation model worked out last year, are becoming available.
- In a study of the kinetics of ion uptake by intact plants from the soil solution, emphasis was put in 1973 on the influence of the ionic charge balance, in a ternary H-P-K nutrient system, on K^+ , phosphate, proton, nitrate uptake. Chloride and sulfate uptake was also considered.
- A certain amount of attention was paid to the problem of reliability of double labelling experiments, using ^{45}Ca , ^{47}Ca and ^{134}Cs , ^{137}Cs , in tomato plants.
- In experiments on isolated chloroplasts, as a model for the ion movement through plant membranes, mainly the interaction between Ca^{++} and Mg^{++} was studied.

In the field of mutation breeding, incompatibility and mutagenesis the following topics were considered:

- by the combination of the adventitious bud technique and mutation breeding of vegetatively propagated crops, again several new commercial mutants of ornamentals were brought on the market.
- research on the development of other *in vivo* and *in vitro* adventitious bud techniques, besides the detached leaf method, is in progress.
- on the basis of the experiments in 1973, final conclusions concerning the localization of unstable chlorophyll mutants genes C₆, C₁₁ and C₁₂ and monosomy induction in *Lycopersicon esculentum* Mill are not yet possible.
- further results on the induction by γ -irradiation of self-compatibility in a self-incompatible dihaploid *Solanum tuberosum* L. clone seem to indicate that this characteristic is indeed radiation induced, of genetic nature, not due to permanent changes in the S-locus, but to changes in some minor genes.
- research on the mutation spectrum induced by mutagenic treatments at the S-locus of pollen mother cells of *Nicotiana glauca* Link and Otto showed that (a) chronic γ -irradiation is very effective in inducing seed-set upon selfing; (b) acute X-rays and fast neutrons induce self-compatibility mutations, presenting a similar spectrum but higher numbers after the fast neutron treatment; (c) no constructive mutations were obtained.
- progress was made in the study of generation of new S-alleles in *Lycopersicon peruvianum* Mill, of the research on marker mutations and the identification of the S-bearing chromosome in incompatible plants of *Nicotiana glauca* Link and Otto.
- with respect to the possible relationship between the S-genotype and the peroxidase isoenzyme pattern no confirmation of the "Pandey-theory" has been found in *Nicotiana glauca* Link and Otto.
- the insensitivity to X- and γ -irradiation of both binucleate and trinucleate types of pollen, suggests the lack of de novo synthesis of respiration enzymes. Apparently other biochemical processes are responsible for the differences in respiration rate of the binucleate and trinucleate types of pollen.
- concerning the X-ray irradiation-dose fractionation effect on *Saintpaulia*-leaves, data on the existence of a radiation-induced protective agent are still inconclusive. Other factors actually considered are: temperature, gas-environment, time interval between irradiations, time interval between detaching of leaves and irradiation and doses of irradiation.

In the food-irradiation part of the programme the following results have to be mentioned:

- insight has been sought into the mechanism responsible for the inhibition of irradiated glucose on growth of microorganisms in foodstuffs.
- a combined heat/irradiation treatment of *Bacillus subtilis* ATCC 6632 resulted in higher radiation resistance in spores containing minimum levels of calcium. Heat resistance, however, increased by calcium addition up to 50 ppm. Spores with higher Mn-content were more resistant to irradiation; heat-sensitivity was much less affected by Mn-content. Ca-inactivation by γ -irradiation is more effective in the presence of iodate. Heat activation (increased viable count colony count) was inactivated by higher irradiation doses in *Bacillus steari thermophilus* strain 1518.

- among the models for testing the influence of water availability on *Enterobacteriaceae* development on an irradiated medium, the model to which microorganisms, at the stationary stage of their growth cycle were added, appeared to be the most suitable.
- practical applications of the food irradiation procedure have been further extended to a certain number of different foodstuffs of economic importance.
- in the field of wholesomeness of irradiated food, a total diet feeding test with domestic pigs is in progress.

The programme on radiation genetic control of insect pest progressed in the following way:

- according to results using *Hylemya antiqua* Meigen, in general the higher the radiation dose administered to the parental generation, the more translocations are recovered in the F₁ offspring. However, for the utilization of translocations as homozygotes in an insect control programme, as low a dose as is practically feasible has to be applied in order to minimise other genetic damage. Inbreeding programmes for the homozygosing of chromosomal aberrations are in progress.
- with respect to genetical control of *Adoxophyes orana* F.v.R., it was observed that after irradiation with 3 krad fast neutrons, as with X-rays (see Annual Report 1972), the F₁ of irradiated females has an average percentage egg hatch higher than or equal to that of the parent generation, while the F₁, originating from the combination with irradiated males, has an average percentage egg hatch which is obviously lower than that of the control. Experimental data obtained up till now do not stress the possibility that the difference between the heredity of chromosomal aberrations in irradiated male and female moths is due to the different timing of meiosis with respect to the moment of irradiation. A start was made with the working out of a mathematical model simulating the effects of the release of moths with different degrees of sterility. Some preliminary information became available from a small scale practical release programme.
- study of the dose-response relationship for dominant lethals, recessive lethals and structural chromosome mutations, induced by irradiation of either males or females of *Tetranychus urticae* Koch with X-rays or fast neutrons.

The following aspects of the methodology part of the programme are worthwhile mentioning:

- development of electronic devices to be used with different analytical apparatus.
- measurement of density gradients and velocity in flowing granular material.
- measurement of residence-time distribution for liquids in a centric therm evaporator.
- measurement of the water-oil ratio in soils.
- the problem of calcium transport in *Phaseolus vulgaris* L. and its localization in bean fruits has been tackled by β -spectrometry with semiconductor detectors and by X-ray fluorescence and scanning electron microscopy.
- study of quenching in Cerenkov-counting when wavelength-shifters are added to the counting liquid.

- determination of small amounts of fission products in fish and fishery products.
- determination of metals in fish and fishery products.

The programme for 1973 has once more been carried out in close cooperation with other scientific institutes and organizations. Examples of this scientific collaboration are:

- on different aspects of the application programme within workinggroups of the European Society of Nuclear methods in Agriculture (ESNA);
- on pollution, radioactive and other, with the Biology Division in Ispra and institutes in the Netherlands, Belgium and Germany;
- on radiation effects within the European Dosimetry working group;
- on standardization of absorbed dose and dose distribution measurements within the European Late Effects Project Group (EULEP);
- on mutation breeding (vegetatively propagated crops, incompatibility, protein improvement, disease resistance) in higher plants in the Mutation Breeding Contact Group;
- on incompatibility in higher plants with several institutes and organizations within the European Community;
- cooperation to projects concerning the testing of irradiated food, wholesomeness testing set up by the Organization for Economic Cooperation and Development (OECD) and the International Atomic Energy Agency (IAEA). In this respect also collaboration exists with institutes in the Netherlands, Denmark, Belgium;
- research on genetic control of insect pests, coordinated in Section VII of the TNO working group "Integrated control of Insect Pests" and in the joint European Working Group of the "Organisation Internationale de la lutte biologique" (OILB). Cooperation within projects of the IAEA and of the entomology programme of the Biology Division.

INSTITUTE OF THE ASSOCIATION EUARTOM-ITAL
P.B. 48, Wageningen, The Netherlands.

Board of Governors

J.A.P. Franke	chairman
J.B. Ritzema van Ikema	vice-chairman
G. Wansink	secretary
T.J. Barendregt	
H.N. Hasselo	
A.C. Schuffelen	

Management Committee

G. Wansink	chairman
R. Craps	
F. van Hoeck	
J.B. Ritzema van Ikema	
A.C. Schuffelen.	

International Scientific Advisory Council

A.C. Schuffelen	chairman
T.J. Barendregt	
H. Laudelout	
H. Laven	
H.F. Linskens	
H. Marschner	
G.T. Scarascia Mugnozza	
G.F. Wilmink	

Changes in the Scientific Staff

New members of the scientific staff are:

Dr. A.S. Robinson from Great Britain, dr.ir. A.F. Groneman, ir. S. Roest, drs. J.A. van Veen and dr. P.A.Th.J. Werry, all from The Netherlands.

- Temporary members (post-graduate fellows) responsible for particular aspects of the programme: Ir. Miss H.M.G. Groot, Miss M. Matteoli, Ir. C. Petit and Ir. J.P. Rolland.

- Several guest-workers have spent 6 to 12 months at the Institute.

Resultaten van het project No. 1.

Hoofd van het team en wetenschappelijke medewerkers:

M.J. Frissel, F. van Dorp en J.A. van Veen

Titel van het project: Quantitative description of the
behaviour of nitrogen in soils.

Beschrijving van de resultaten:

The project was started with an extensive investigation of the literature concerning the microbial aspects of nitrogen behaviour in soils. In consult with fellow-workers of the Institute of Soil Fertility, Haren (Gr.), it was decided first to make an evaluation of the existing models described by Paul and Domsch (Braunschweig), Knowles et al. (Stevenage), McLaren (Berkeley), Cho (Winnipeg) and Beek & Frissel.

Resultaten van het project No. 3.

Hoofd van het team en wetenschappelijke medewerkers:

F. van Dorp, J. Sinnaeve, M.J. Frissel, P. Peolstra.

Titel van het project: The ionic composition of the soil solution as a function of time and place with respect to the ion uptake by plant roots.

Beschrijving van de resultaten:

To study the interactions between plant roots and their surrounding solid medium, plants are grown in a climate controlled environment (see project 6) on solid media. As a step between experiments with nutrient solutions and experiments with soil, plants are grown on ion exchange resins mixed with some inert substance to improve the physical properties.

The CSMP-computer simulation model, written last year, described ion uptake by one root growing in soil. We hope that the approach worked out will deliver the necessary data concerning root geometries. The parameters of the synthetic media (e.g. water content, hydraulic conductivity, ion concentration in the equilibrium solution, diffusion constants of ions, redoxpotential) will be determined in function of the properties of different resins.

We first studied a strong acid exchanger (Dowex 50W) and a strong base exchanger (Dowex 21K) with an exchange capacity of respectively 1.9 and 1.2 me/ml wet resin. We charged 5 ml of Dowex 50W by percolation with a Hoagland-Arnon 1 nutrient solution (fig. 1 and 3). After percolation of 2 liters of solution (containing 20 me/l) equilibrium was attained. The adsorption complex was then charged with 84.3% calcium, 12% magnesium and 3.7% potassium. The preparation of sufficient quantities of resin for plant growth would, however, require enormous volumes of nutrient solution. Therefore, the adsorption characteristics were determined with a 10 times concentrated nutrient solution (see fig. 2 and 4). At equilibrium 76.5% calcium, 12.3% magnesium and 12.2% potassium were adsorbed. A more concentrated solution can not be prepared as CaSO_4 precipitates. However, to saturate enough resin, also too much of a 10 times concentrated Hoagland-Arnon nutrient solution would be necessary. We therefore decided to saturate separately portions of the resins with the different ions. Dowex 50W and Dowex 21K were prepared that way and mixed with sand. A growth experiment with barley (*Hordeum vulgare* L. cv. Aramir) was carried out (see project 6). As this experiment was not successful, we tried to improve the

physical properties of the medium by mixing the resin with agraperlite instead of fine sand. Agraperlite is a porous material made of vulcanic stone by heating it at 1200-1500 °C, used in two different sizes, coarse and medium coarse. The following physical properties of agraperlite were determined: it has no significant exchange capacity and has a specific weight of 2.4 g/ml, the pore volume is 96%. Fig. 5 gives the volumetric distribution of air, water, and agraperlite in function of the water tension. The results of the growth experiment with resins mixed with agraperlite demonstrated an improvement of the growth medium for water and oxygen management. However, the delivery of nutrients by the strong acid resin seemed to be insufficient (see project 6).

So the study of the strong base exchanger Dowex 1 and the weak acid Amberlite IRC50 was started in a similar way. They have an exchange capacity of resp. 3.7 and 10.3 me/g dry resin and a specific weight of 0.7 and 0.6 g/ml with a pore volume of 55% in the wet material for both types. The amberlite type is more suitable for plant growth than the Dowex 50W. Amberlite in potassium form percolated with water releases measurable amounts of potassium (see fig. 6), whereas Dowex 50W does not. The irregularities in the curve in fig. 6 may be due to changes in the percolation velocity. The high preference for H^+ of Amberlite IRC50 gave some difficulties to saturate the resin with calcium and magnesium, but by mixing the resin with suspensions of calcium and magnesiumhydroxide a complete saturation of the adsorption complex seems to be possible.

Instrumentation to study the concentration of nutrients in the equilibrium solution is being prepared. Small amounts of this solution are continuously extracted with a microdrip (1 ml per 24 hours) in which ionic activities will be measured with micro-electrodes.

Apparates for measuring diffusion constants of ions in the media at different water tensions have been designed and experiments will be conducted in 1974.

Publications 1973.

Calculation of composition of the exchange complex and the soil solution for four cations.

Contribution to: "Simulation of accumulation and leaching in soils" Edited by M.J. Frissel and P. Reiniger (In preparation).

Legends of the figures

- fig. 1. - me nutrients adsorbed on 5 ml Dowex 50W in function of the amount (liters) normal Hoagland-Arnon I nutrient solution percolated. (calculated from fig. 3).
- fig. 2. - me nutrients adsorbed on 5 ml Dowex 50W in function of the amount (liters) 10 times concentrated Hoagland-Arnon I nutrient solution percolated. (calculated from fig. 4).
- fig. 3. - me/l in the effluent of 5 ml Dowex 50W in function of the amount (liters) normal Hoagland-Arnon I nutrient solution percolated.
- fig. 4. - me/l in the effluent of 5 ml Dowex 50W in function of the amount (liters) 10 times concentrated Hoagland-Arnon I nutrient solution percolated.
- fig. 5. - distribution of air, water, agraperlite fine (line 1) or agraperlite medium coarse (line 2) in function of the water tension.
- fig. 6. - concentration (me/l) of K^+ in the effluent of 0.1 gramme dry Amberlite IRC50 (saturated with K^+) percolated with water (velocity 47 ml/hour).

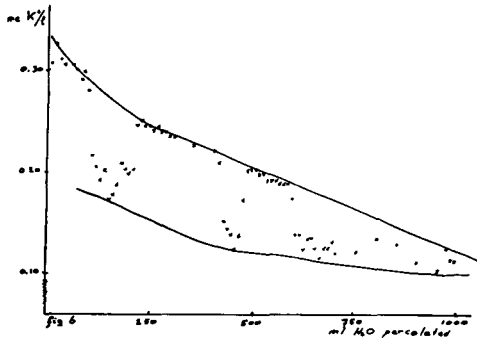
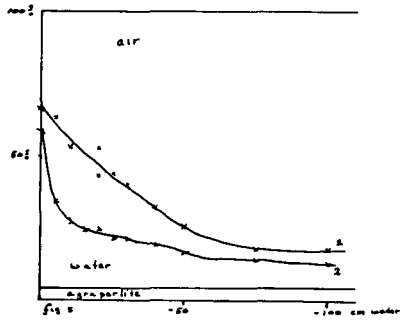
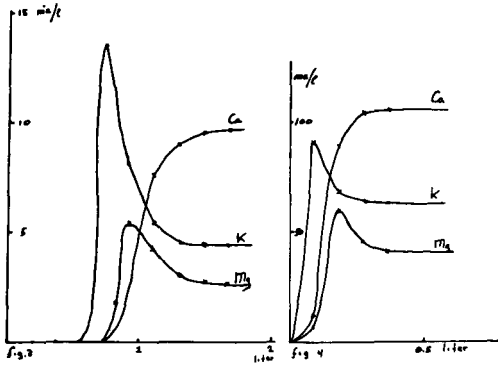
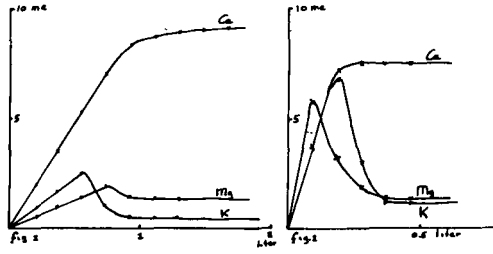

Resultaten van het project No. 4

Hoofd van het team en wetenschappelijke medewerkers:

J.P. Rolland, M.J. Frissel, P. Poelstra.

Titel van het project: Transport of pesticides (insecticides, fungicides) and herbicides in soils.

Beschrijving van de resultaten:

The main processes which affect pesticide action in soil are considered to be the extent at which the pesticide is absorbed by soil, the rate at which it is lost from the soil by decomposition, the evaporation and/or leaching. The effectiveness of a biocide in controlling many undesirable effects is primarily due to its persistence, which represents the final result of interactions of all biological, physical and chemical processes occurring in soil, and its mobility in the environmental system.

Two compounds, one insecticide and one herbicide were further tested on their adsorption properties and their movement in soil columns.

Trichloronate ($C_{10} H_{12} O_2 Cl_3 P S$), an insecticide, and Bam (2,6-dichlorobenzamide, $C_7 H_{11} O Cl_2 N$), a microbial decomposition of Dichlobenil ($C_7 H_9 Cl_2 N$), an herbicide controlling perennial crops, were sprayed at a dose of respectively 6 and 4 mgr on two homogeneous sand columns (diameter 12 cm; length 90 cm). A continuous artificial rain (daily 2.55 ml/cm^2) containing 0.005 N $CaCl_2$, KCl, NaCl and regulated by an automatic rain simulator, was applied at the top of the column. Every day an effluent sample was taken and analysed by Gas Liquid Chromatography, Electron Capture detector in order to detect the leaching of Trichloronate or Bam from the columns.

Every week a complete scanning of the columns was made using a two-gamma-sources (^{241}Am and ^{137}Cs)-detector. After calibration and careful determination of the mass attenuation coefficient characteristics for the two sand columns, simultaneous measurements of dry bulk density and volumetric moisture content were performed and compared with satisfying agreement to final analysis occurring at the end of each experiment.

The columns profiles were cut in layers of 1 or 2 cm at the end of the experiment and the final distribution of Trichloronate and Bam residues was determined using a common extraction method with ethylacetate.

Furthermore, a mixture of soil and solution (150 g dry soil with 400 ml pesticide solution at various concentrations) was shaken during 6 hours in 700 ml flasks. At varying time, 5 ml aliquots were pipetted and, after

centrifugation (10 min at 3000 rpm) and extraction with ethylacetate, the supernatant was withdrawn for GLC analysis. Estimates for the adsorption rate constant for Bam was obtained using experimental data and an algorithm programme in order to evaluate the first order kinetic equation constants given by Fave and Eyring (J. Phys.Chem. 60, 890 (1956)); this equation takes into account the backward-reaction as well.

The mobility of Trichloronate is very small if compared with Bam. After 61 days of artificial rainfall (170 cm H₂O) 55% of the initial amount of Trichloronate (52 microg/cm²) remained in the upper 11 cm (fig. 1) of the column while no traces of the pure compound were found in the effluents (amount decomposed: 45% corresponding to an half live of 60 days).

In contrast 68% of the sprayed Bam (35,4 microg per cm²) was leached through the profile (see breakthrough curve fig. 2) and the residues were uniformly adsorbed along the column (12.10⁻² microg per cm³ bulk soil); no decomposition occurred.

These experiments were conducted at about 40% of the maximum water saturation (fig. 3 and 4) and considering the moisture content determined during experiment by the two-gamma-sources-detector with the final determination, a constant water flow was attained; unfortunately, the accuracy of this non-destructive method is, at the time being, unacceptable for heterogeneous profiles.

Several computation models were built which considered successively convection diffusion and hydrodynamic effects.

Analytical solutions (plate model of Glueckauf, chromatographic equation of Lapidus and Amundson and other solutions of the Focken Planck equation with appropriate boundary conditions) are compared with corresponding numerical solutions computed by CSMP programmes. In the numerical solutions the spreading of the concentration over the soil profile is overestimated. This phenomenon, called the artificial spreading, is caused by the use of finite intervals in space and time instead of infinitesimal intervals. A few procedures are tested to suppress this artificial spreading and applied to more elaborate models.

A first mathematical model taking into account an instantaneous equilibrium between solid and liquid phase (linear adsorption isotherm) was compared with a model considering first order kinetics for adsorption and desorption. The adsorption isotherm was again taken linear, but the desorption reaction is only partly reversible. In both cases convection and diffusion processes

(in liquid and gas phase) were involved, also diffusion from the soil surface was taken into account. Attention was paid to the apparent diffusion coefficient and suppression of artificial spreading effects. Furthermore decomposition of the pesticide both in solid and liquid phase was included. The instantaneous equilibrium model was applied to the leaching of Trichloronate in a sandy column. Although some important parameters, as the rate factor for the decomposition (2.10^{-3} fraction per day) and the distribution ratio between solid and liquid phase (20 microg pest. per g soil/microg pest. per cm^3 soil solution) were determined independently, the agreement between experimental and calculated values is moderate (see fig. 1). The application of the non instantaneous model will be carried out as soon as the required parameters (adsorption and desorption rates) are measured.

The just mentioned parameters were already determined for Bam: adsorption rate constant (560% per day), desorption rate constant (100% per day), distribution ratio between solid and liquid phase (0.23 microg pest. per g soil/microg pest. per cm^3 soil solution), decomposition rate (negligible for the duration of the experiment). From the leaching experiment it appeared, however, that irreversible adsorption plays a significant role (an average of 0,12 mg per cm^3 bulk soil remained absorbed under the experimental conditions). This irreversibility invalidates the determined distribution ratio of $0.23 \text{ cm}^3 \text{ g}^{-1}$. This is clearly demonstrated in fig. 2. Application of a distribution ratio of $0.23 \text{ cm}^3 \text{ g}^{-1}$ in the equilibrium model results in a breakthrough curve which is much later than the experimental one. The curves for the, at this moment arbitrarily chosen values 0.02 and $0.03 \text{ cm}^3 \text{ g}^{-1}$ show better agreement. (Multiplication of the distribution ratio (0.025 microg pest. per g soil/microg pest. per cm^3 soil solution) with the bulk density (1.7 g soil per cm^3 bulk soil) and dividing by the water content (0.2 cm^3 soil solution per cm^3 bulk soil) gives an R_f of $1/(1+0.025 \times 1.7 : 0.2) = 0.82$). The equilibrium model does not consider the irreversible adsorption, the amount remaining in the column is neglected, which makes the agreement less good than the curves suggest. The result of the application of the non-instantaneous equilibrium model is therefore much better, it takes logically into account the irreversibly adsorbed amount and shows the tailing effect which is so typical for many pesticide leaching experiments. The value for the distribution ratio ($0.03 \text{ cm}^3 \text{ g}^{-1}$) is the only one adapted to fit the experiments. An independent determination of the distribution ratio is not possible for such systems.

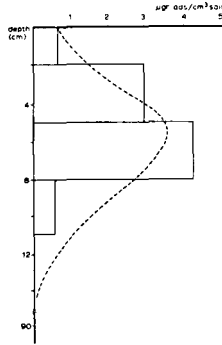

fig. 1. Trichloronate adsorbed in relation to depth after 61 days of artificial rain and application of $50 \text{ microg.cm}^{-2}$ (column 90 cm length)

———— experimental result
 ----- theoretical curve (instantaneous equilibrium and decomposition coefficient of 2.10^{-3})

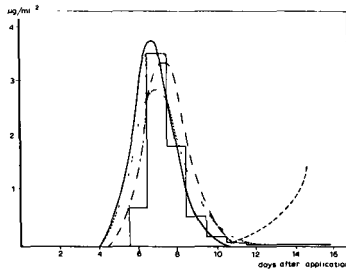

fig. 2. Breakthrough curve of Bam in function of time after spray ($35.4 \text{ microg.cm}^{-2}$) application.

———— experimental result (disturbed sand column)
 theoretical curve (non-instantaneous equilibrium simulation model) $\text{KSW}=0.03$, $\text{ADSRT}=5.6$ and $\text{RELRT}=1$.
 -.-.-. theoretical curve (instantaneous equilibrium s.m.) $\text{KSW}=0.23$
 ----- theoretical curve (instantaneous equilibrium s.m.) $\text{KSW}=0.02$
 -...-... theoretical curve (instantaneous equilibrium s.m.) $\text{KSW}=0.03$

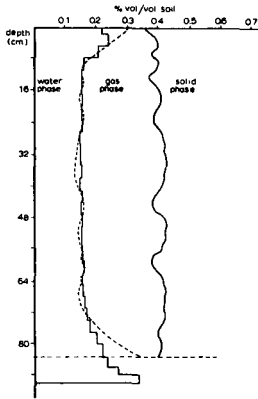

fig. 3. Physical description of the sand profile used for Bam leaching experiment.

————— moisture content: analysis determination
 - - - - - moisture content: two-gamma-sources detector

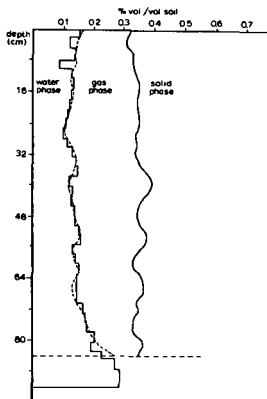

fig. 4. Physical description of the sand profile used for Trichloronate leaching experiment

————— moisture content: analysis determination
 - - - - - moisture content: two-gamma-sources detector.

Resultaten van het project No. 5

Hoofd van het team en wetenschappelijke medewerkers:

J.H. Becking

Titel van het project: Chemistry and biology of nitrogen in soils

Beschrijving van de resultaten:

1. Results

The experiments on the effect of nitrogen-fixing algae on the eutrophication of natural water were continued. The uptake and the utilization of different sources of phosphate (ortho-, meta-, and poly-phosphate) were tested with *Nostoc* sp. and *Anabaena* sp. strains in pure culture growing at the expense of molecular nitrogen from the air. It was confirmed that these blue-green algae can grow on meta- and poly-phosphate as sole source of phosphorus, the growth on poly-phosphate was better than on meta-phosphate. This indicates that blue-green algae under natural conditions with molecular nitrogen can produce growth and proliferation on poly-phosphates released by the introduction of detergents and synthetic soaps containing phosphates as effluents in surface water. In the analyses the difficulty was encountered that no chemical method was found to distinguish between ortho-, meta-, and poly-phosphate. Therefore, no insight could be obtained in the source of phosphate contamination occurring naturally in surface water. It is quite feasible that the amounts of phosphates released to surface water are partly ortho-phosphates from agricultural practice of phosphate (superphosphate) dressing and not due to sewage contamination. Moreover, it is possible that the blue-green algae split first the phosphate polymer in a monomer before utilization. Such a reaction can not be followed, because of the lack of a chemical method discriminating between both phosphate species. Blue-green algae responded to extreme low phosphate levels (0.1 - 0.3 mg P per litre) in the medium. Therefore it is possible to use these algae as an accurate biological assay method for the determination of available phosphate in natural waters. In figure 1 the relation between the growth of the blue-green alga (mg N per 100 ml medium) and phosphate levels in the medium (0.1 - 1.0 mg P per litre) is given. The hyperbolic shape of the curve indicates a saturation effect at the higher phosphate levels like in an adsorption curve. Plotting the reciprocal values, i.e. 1/growth against 1/phosphate concentration a linear relation is obtained for the lower phosphate concentrations. Also a chemical method was tried to determine inorganic phosphate in solution. The very sensitive test with sodium

molybdate producing phosphate molybdate, which was subsequently complexed with a methyl green dye was used (Van Belle, Analytical Biochemistry 33, 1970: 132). This method gave less satisfactory results than the bio-assay and moreover its best range was about 3 mg PO₄-P per litre being about 10 times higher than the bio-assay method.

Algae occurring in the surface water of lakes (Veluwe Meer) were classified in order to get an insight in the eutrophication process of the water. In normal lake water green algae belonging to *Scenedesmus* species (Proto-coccales) proved to be common. In the eutrophication process these algae are replaced by blue-green algae such as *Aphanizomenon flos aquae* (L.) Rafs., *Anabaena flos aquae* (Lyngb.) Br5., other *Anabaena* species and *Nostoc* species. Very polluted water (such as near the harbour and the beach of Harderwijk) contained as dominant organism the blue-green alga *Oscillatoria agardhii* Gomont. In laboratory experiments *Oscillatoria agardhii* proved to be rather difficult to cultivate and it is likely that this species is non nitrogen fixing. Presumably it grows saprophytically on complex organic compounds produced by the lysis of preceding algal associations.

So far not a systematic survey was made of the algal populations with regard to season, time of the day, temperature, light intensity and chemical quality of the water. Such determinations are rather time consuming and laborious. Since it was found that the Rijksdienst of the IJsselmeerpolders does routinely such determinations at a large number of sites in the IJsselmeerpolders and moreover to avoid duplication, I asked the Direction of the IJsselmeerpolders for a cooperation in research. It was suggested that the IJsselmeerpolder service would do the more ecological research as they have done so far and would provide us with the parameters (chemical quality of the water, pH, pO₂, etc.), related to a bloom of *Oscillatoria agardhii*. Our contribution would then be to do laboratory experiments with chemostats (continuous cultures) testing the parameters obtained in the field and simulating such an eutrophication process *in vitro*.

2. Cooperation

An exchange of results was suggested with Prof. Dr. D.W. Tempest and Dr. L.F. Mur (Laboratory of Microbiology, University of Amsterdam), who recently have started a project on the effect of blue-green algae on the eutrophication of natural waters. In relation to this, it was advisable to join the working group "Aquatic Ecology" of the BION, coordinating all aquatic ecological research in The Netherlands. Moreover, a cooperation was suggested with

Ir. G. Berger of the Rijksdienst of IJsselmeerpolders at Lelystad with regard to the planned chemostat experiments simulating the eutrophication process of water by *Oscillatoria agardhii* in model experiments. With regard to the latter I recently received a positive answer.

Publications - 1973

BECKING, J.H. N_2 fixing root associations in higher plants other than Legumes. In "Dinitrogen (N_2) Fixation", vol 2 (Ed. R.W.F. Hardy), John Wiley Sons, U.S.A. (in press).

BECKING, J.H. Putative nitrogen fixation in other symbioses. In "Biological Nitrogen Fixation" (Ed. A. Quispel), North-Holland Publ. Co., Amsterdam (in press).

BECKING, J.H. Nitrogen fixation in some natural ecosystems in Indonesia. In Proceedings International Synthesis meeting Biologica Nitrogen Fixation and the Biosphere, Edinburgh, September 1973, International Biological Programme, Cambridge Univ. Press (in press).

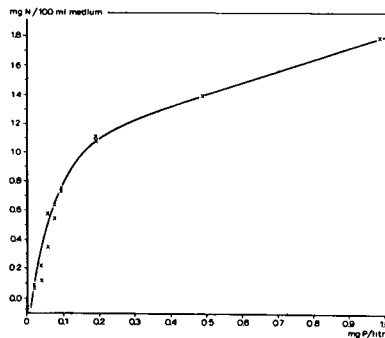

fig. 1. Nitrogen fixation by *Noctoe* sp. (mg N per 100 ml medium) in relation to phosphate levels (mg P per litre) of the medium.

Incubation at 29°C on a rotary shaker, light intensity 10,000 lux.

Resultaten van het project No. 6

Hoofd van het team en wetenschappelijke medewerkers: J.Sinnaeve
F.van Dorp, M.J.Frissel

Titel van het project: Ion uptake by intact plants from the soil
solution or from the equilibrium solution of
a synthetic resin. Experimental and simula-
tion model approach.

Beschrijving van de resultaten.

The preliminary study of the composition of a synthetic growth medium, started in 1972, was continued and an experimental approach, in order to get relevant data, was worked out. It differs from the conventional studies on mineral nutrition. The scope is not to study a particular mechanism by varying some parameters, e.g. temperature, concentration or absorption time, but its aim is to describe the complex mechanism of mineral nutrition with regard to the major elements as a unity by the use of simulation models. This requires, however, the availability of complete nutritional balances obtained in controlled and reproducible conditions for plants growing in solid substrates.

A first step in the evaluation of the suitability of a synthetic medium was the determination of the immobilization rates of the major elements (Ca^{++} , Mg^{++} , H_2PO_4^- , and NO_3^-) as well as the transpiration rates for several plant species (barley (Hordeum vulgare L. cv. Aramir), maize (Zea mays L- cv. Ona), spinach (Spinacia oleracea L.cv. Winterreus) and pea (Pisum sativum L.cv. Allround)), in gravel culture using a Hoagland-Arnon I nutrient solution. Two seventy day experiments with the four plant species in two different plant densities have been carried out. Specially developed growth vessels establishing a constant solution level within the gravel and equipped with a window for photographic registration of the root development and the root penetration were used. These results from which one series is presented in figure 1 will be used to check the nutrient availability of the selected medium.

A growth experiment with barley (Hordeum vulgare L.cv.Aramir) using a strong acid exchanger (Dowex 50 W) and a strong base exchanger (Dowex 21 K) was carried out. Some physical properties of the resins used are described in the report of the related project 3/61. The two resins were mixed together and were diluted with pure sand (table 1). None of the mixtures gave satisfactory results (strong growth retardation and nutrient deficiency) what

probably was due to the insufficient aeration of the medium, the unadapted water management (insufficient capillary rise with a water table at a depth of 30 cm) and the strong cationic selectivity of the cation exchanger. A new series was started using the same resin types but diluting the medium with a perlite having no exchange complex. A non sieved coarse (up to a particle diameter of 4 mm) and a sieved medium coarse (0.6 to 2.5 mm) agraperlite (heated vulcanic stone) were used. The four plant species specified before were used and the plants were growing from the seedling stage on, in small columns (5 cm diameter) with the water level at a depth of respectively 30, 35, 40, and 45 cm. The columns were filled with 61.6% of agraperlite, 11.5% of NO_3^- resin, 2.5% of SO_4^{--} resin, 2.5% of H_2PO_4^- resin, 15.3% of Ca^{+++} resin, 3.3% of Mg^{++} resin and 3.3% of K^+ resin. The aeration of the medium was considerably improved and the growth of the plants was less retarded although nutrient deficiency appeared later on. New experiments using a weak cationic exchanger (Amberlite IRC 50) and another strong anionic exchanger (Dowex 1) will be started in 1974.

A detailed description of two types of growth chambers with different illumination geometries and an adapted air conditioning unit controlling wind speed, temperature, relative humidity and CO_2 concentration was worked out. We hope the proposed approach will permit the evaluation of all the growth factors to be taken into account in the simulation models and will enable us to study the root development in solid substrates. The environmental parameters of roots and shoots are controlled such that the photosynthetic activity of the plants can be kept constant at a given level.

No	anionic resin	cationic resin	pure sand	NO ₃ ⁻ resin	SO ₄ ⁻⁻ resin	H ₂ PO ₄ ⁻ resin	Ca ⁺⁺ resin	Mg ⁺⁺ resin	K ⁺ resin
1	.84	.84	2.52	.40	.40	.040	.70	.10	.03
2	.42	1.26	2.52	.20	.20	.020	1.00	.14	.05
3	.28	1.40	2.52	.15	.15	.015	1.09	.16	.05
4	1.26	1.26	1.68	.60	.60	.060	1.00	.14	.05
5	.63	1.89	1.68	.30	.30	.030	1.50	.22	.07
6	.42	2.10	1.68	.20	.20	.020	1.68	.24	.08
7	1.68	1.68	.84	.80	.80	.080	1.34	.19	.06
8	.84	2.52	.84	.40	.40	.040	2.02	.29	.10
9	2.10	2.10	0.00	1.00	1.00	.100	1.68	.24	.08

Table 1 : Composition of different synthetic resin media used in a preliminary growth experiment with barley. Two plants were growing in 4.2 litres of substrate. All quantities are expressed in litres.

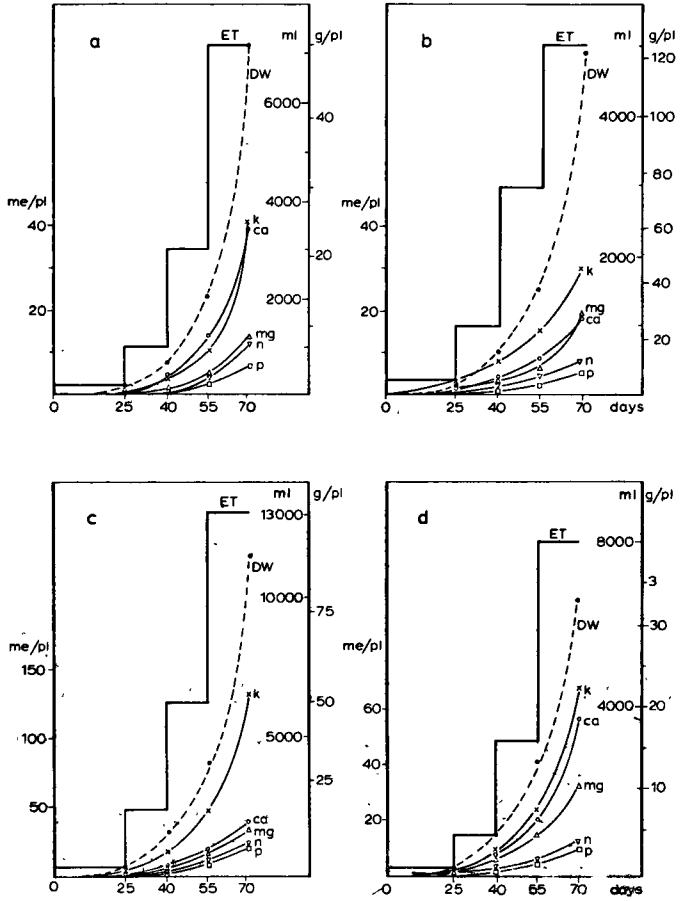

fig. 1. Growth experiment with pea (A), maize (B), barley (C), and spinach (D) plants 10 cm apart. The concentration of K^+ , Ca^{++} , Mg^{++} , NO_3^- and $H_2PO_4^-$ is given in milliequivalents per plant (me/pl). The dry weight (DW) is given in grams per plant (g/pl) and the evapotranspiration (ET) in millilitres (total amount over the period considered (3 times half an hour aeration per day)).

Resultaten van het project No. 7

Hoofd van het team en wetenschappelijke medewerkers:

G. Verfaillie

Titel van het project:

Study of kinetics of ion uptake by intact plants

Beschrijving van de resultaten:

In 1972, the qualitative interference of various ionic components of an Hoagland nutrient solution on the proton uptake by rice plants (*Oryza sativa* L. cv. arborio) from a proton-phosphate binary system (H-P) had been put in evidence.

In 1973, more quantitative results have been obtained about the ionic balance prevailing during the ion uptake by the plants from binary and more complex systems.

The most interesting results obtained in this study are:

1. Proton- and phosphate uptake from an H-P binary system.

Results obtained with a pure 1.5 N H_3PO_4 solution.

Phosphate uptake followed by radioactive tracing with ^{32}P .

Total acid uptake (bound protons and H^+ ions) has been calculated as a function of the phosphate uptake and of the pH variations according to the theory already presented in the annual report 1972.

- The pH increases regularly from pH 3.4 and tends toward an equilibrium value vicinating 4.2 (Fig. 1 curve A).
- The uptakes of the phosphate and of the protons expressed in micro-equivalents per gram fresh root and plotted against the time give two curves overlapping exactly each other (fig. 1 curve B).
- After experiment, no trace of any other ion could be detected in the nutrient solution indicating that no ionic exchange has taken place during the uptake processes.
- The ratio $\Delta H/\Delta P$ is remained constant and equal to 3; this means that the uptake of each mole phosphate has been balanced by:
2 equivalents of bound protons ($H_2PO_4^-$)
1 equivalent of H^+ ions.

2. Uptakes from the H-P-K ternary system.

Nutrient solution: 1 mM KH_2PO_4 acidified with H_3PO_4 .

Potassium uptake has been calculated by difference.

- The presence of the K^+ ions increases the phosphate uptake rate and, consequently, the proton uptake rate. (Fig. 1 curves C and D).
- The pH does not merely vary as long as the concentration of K^+ has not been reduced to a value smaller than 0.2 mM (fig. 1 curve F).

- The charge balance is merely realized by the uptake of K^+ ions. (Fig. 1 curve E).

The ratio $\Delta H/\Delta P$ for K^+ concentration smaller than 0.2 mM increases from 2 to 2.2 when the K^+ concentration decreases. This means that each mole of phosphate taken up is ionically balanced by:

- 2 equivalents bound protons ($H_2PO_4^-$)
- 1 to 0.8 equivalent K^+ ions.
- 0 to 0.2 equivalent H^+ ions.

3. Interference of the nitrate uptake with the H-P-K ternary system. (Fig. 2).

Nutrient solution 1 mM KH_2PO_4 without acidification but with a later injection of KNO_3 bringing the nitrate concentration to that of an Hoagland solution (15 mM).

- Before the nitrate injection, the pH decreases from 4.7 and tends toward the equilibrium value. Immediately after the nitrate injection, the pH increases rapidly together with the rate of acid uptake but the phosphate uptake slows down.
- The ratio $\Delta H/\Delta P$ passes suddenly from 2.05 to 8.8 indicating that the nitrate uptake is accompanied by a consumption of H^+ with a high stoichiometry.

4. Interference of the sulfate uptake with the H-P-K system. (Fig. 3).

Nutrient solution: 1 mM KH_2PO_4 at equilibrium pH (phase I).

First injection of $MgSO_4$ at the level of 2 mM (phase II).

Second injection of KNO_3 at the level of 5 mM (phase III).

- The pH decreases immediately after the injection of the sulfate. This is predicted by the theory if SO_4^{--} is the only one sulfate species taken up by the plants (shift in the equilibrium of the ionic dissociation of the diprotic sulfuric acid).
 - Small increase of the proton uptake rate but high increase of the phosphate uptake rate.
 - The ratio $\Delta H/\Delta P$ passes from the value 2.24 (phase I) to the value 1.53 (phase II). This means that while each mole of phosphate is taken up, 1.47 equivalent H^+ and bound protons are involved in the process of sulfate uptake.
 - The later injection of nitrate produces the rapid reincrease of the pH (phase III) for the reasons explained in the preceding paragraph.
- ### 5. Interference of the chloride uptake with the H-P-K system. (Fig. 4).
- Nutrient solution: acidified 1 mM KH_2PO_4 at equilibrium pH (phase I).
- Injection of KCl at the level of 5 mM (phase II).
- The pH increases linearly after the injection of the chloride.

- The ratio $\Delta H/\Delta P$ passes from the value 2.3 (phase I) to the value 3 (phase II). Each mole phosphate taken up is exactly balanced by 2 equivalents bound protons and 1 equivalent H^+ ions as in the binary system H-P (see fig. 1A). To put this in a better evidence, the coordinates have been shifted in order to bring the origin at the KCl injection.
- Everything looks as if the Cl^- could suppress the degree of freedom produced by the presence of K^+ or as if the Cl^- uptake would be linked to that of $H_2PO_4^-$ with an extra stoichiometric consumption of 1 H^+ ion.

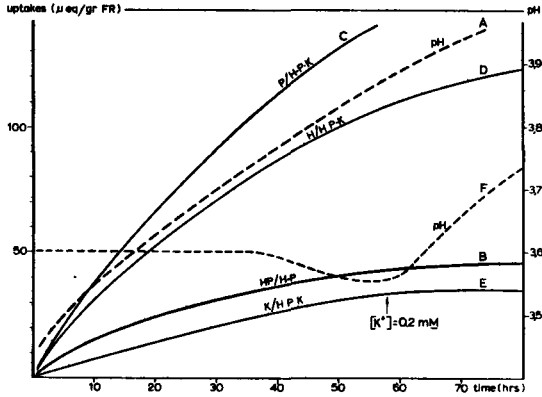

fig. 1. Ionic balances during the uptakes from H-P and H-P-K systems.
 Curve A: pH variations for binary H-P system.
 Curve B: proton- and phosphate uptakes for H-P binary system.
 Curve C: phosphate uptake for H-P-K ternary system.
 Curve D: proton uptake for H-P-K ternary system.
 Curve E: potassium uptake for H-P-K ternary system.
 Curve F: pH variations for H-P-K ternary system.

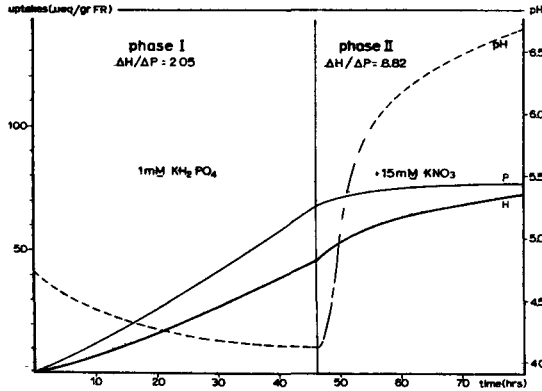

fig. 2. Influence of the nitrate uptake on the H-P-K system.
 Phase I : H-P-K reaching dynamic equilibrium.
 Phase II : effect of the nitrate uptake after injection of KNO₃.

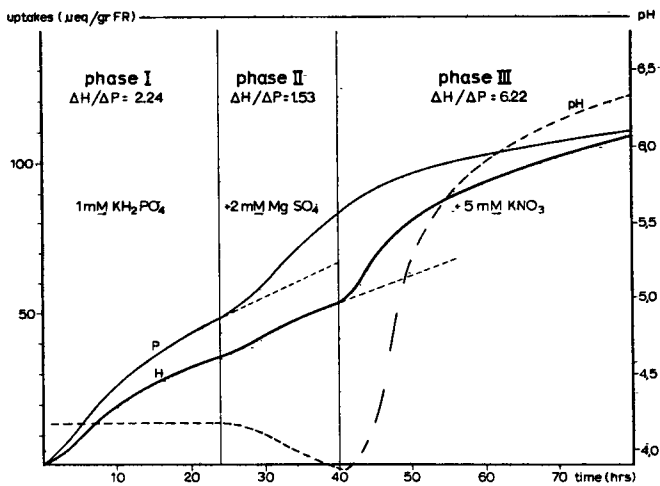

fig. 3. Influence of the sulfate uptake on the H-P-K system.
 Phase I : H-P-K in dynamic equilibrium.
 Phase II : effect of the sulfate uptake after injection of $MgSO_4$
 Phase III : cumulated effect after injection of KNO_3 .

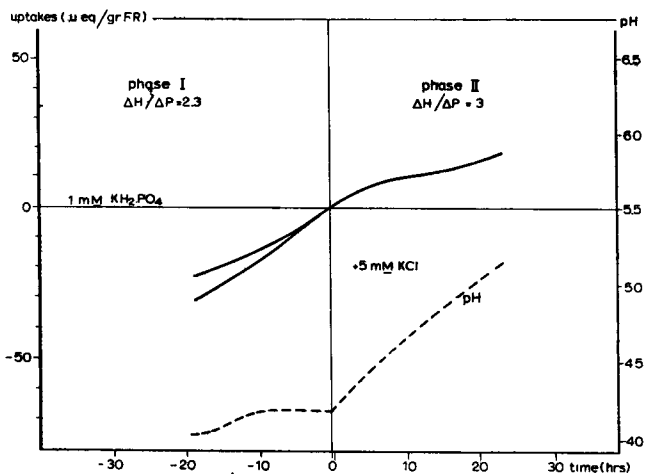

fig. 4. Influence of the chloride uptake on the H-P-K system.
 Phase I : H-P-K in dynamic equilibrium.
 Phase II : The chloride uptake reduces the behaviour of the H-P-K system to that of the H-P system.

Resultaten van het project No. 8

Hoofd van het team en wetenschappelijke medewerkers: A.Ringoet,
J.Sinnaeve, S.C.van de Geyn, M.J.Frissel

Gast medewerker: S.Jait (Institut agronomique et vétérinaire
Hassan II Rabat, Morocco)

Titel van het project: Ion uptake by roots from diluted solutions.

Beschrijving van de resultaten.

Double labelling experiments as described in the ESNA report of the joint sessions of the working groups 5 and 7 (Nuclear techniques in the study of soil-plant relationships and Environmental pollution) of the annual meeting in Budapest 1972 to investigate the reliability of double labelling experiments were carried out. Tomato plants (Lycopersicon esculentum Mill. cv. Marettte VF) were grown in controlled conditions using a diluted (10 times) Hoagland-Arnon I nutrient solution (3.02 me/l). Two elements were considered calcium as an element already present in the plant material and cesium as an element originally not present. Three different concentrations of the stable elements combined with different ratios of the two isotopes of the element considered were used. The stable calcium and cesium concentrations were varied between respectively 0.2 and 20 mg/l and 0.3 and 30 mg/l. For each concentration of the stable element, the two isotopes (respectively ^{45}Ca and ^{47}Ca and ^{134}Cs and ^{137}Cs) were given in different proportions with a ratio ranging between 0.02 and 50 and a specific activity ($\mu\text{Ci}/\text{mg}$) ranging between 0.0017 and 17 for the cesium absorption experiments and 0.025 and 62.5 for the calcium absorption experiments. For these experiments, the ratio of the concentrations of the two isotopes in roots, stems and shoots was compared to the same ratio in the nutrient solution.

Another experiment only considering cesium and its both isotopes, has been done to study the immobilization of the ions in different plant organs. Roots, stems and different leaf samples (cotyledonus leaves, first compound leaves, etc., and tops) were constituted. Only one stable cesium concentration (0.2 me/l) was combined with four labelling ratios (ranging between 0.1 and 10) was considered, the specific activities were 10 to 50 times higher than those given before.

The calcium samples were counted making use of the Cherenkov effect for the ^{47}Ca isotope (β -radiation of 1.98 MeV and 0.67 MeV) and normal scintillation counting for the ^{45}Ca isotope. The threshold value for Cherenkov counting is admitted to be about 0.7 MrV but unfortunately it appeared that even softer emitters (f.i. the 0.6 MeV β -radiation of the ^{47}Sc daughter of ^{47}Ca) were counted in bottles with good light scattering properties (plastic counting vessels). The interpretation of the results is hazardous because, not expecting the influence of the softer β -radiations of the scandium daughter, we did not allow sufficient time for the establishment of equilibrium between ^{47}Ca and ^{47}Sc .

The cesium samples are actually counted with a germanium-lithium crystal connected to a multichannel analyzer. Peak areas are computed by polynomial fitting and background correction. A detailed statistical analysis of the counting procedure has been done. Based on these observations, two counting times, in function of the isotopic ratio, were chosen (500 minutes for samples with a ratio equal to 0.02 and 50 (1.4% standard deviation) and 167 minutes for samples with a ratio equal to 0.1 or 10 (2.2% standard deviation). Due to the long counting times and to the number of samples (more than 300), statistical interpretation of the results could not yet be carried out.

Publications - 1973.

SINNAEVE J. and J. WIENEKE: Detailed proposal for a double labelling ion uptake experiment.

Report of the joint sessions of the working group 'Nuclear techniques in the study of soil-plant relationships' and the working group 'Environmental pollution'.

Annual ESNA-meeting, September 26-29, Budapest, Hungary.

FRISSEL M.J.: Preparation: labeled plant tissue samples for liquid scintillation counting. In Proceedings of the research Institute of Pomology. Skierniewice - Poland - 1973, no. 3.

Resultaten van het project No. 9.

Hoofd van het team en wetenschappelijke medewerkers:

G. Desmet, A. de Ruyter.

Titel van het project: Uptake and release of ions by subcellular structures, mainly chloroplasts and mitochondria.

Beschrijving van de resultaten:

The chloroplasts are isolated as described in previous reports from spinach plants (*Spinacea oleracea* L. cv. Amsterdams Reuzeblad)

However, a more complex isolation medium is used, consisting of 5×10^{-2} M TES pH 7.6, 0,35 M saccharose, 0,1 M KCl, and a variable concentration of Mg^{++} .

The influence of the Mg^{++} , present in this medium, on the Ca^{++} absorption by dark chloroplasts is investigated. The result is presented in fig. 1. From this experiment, it becomes clear that Mg^{++} shows a concurrency for the Ca^{++} absorption sites of the chloroplasts

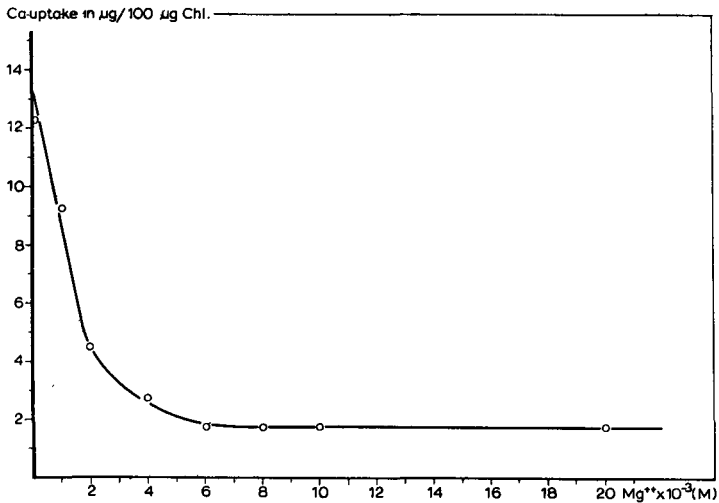

fig. 1 - Influence of Mg^{++} on the Ca^{++} absorption by chloroplasts.

Resultaten van het project No. 10

Hoofd van het team en wetenschappelijke medewerkers:

C. Broertjes, S. Roest, G.S. Bokelmann

Titel van het project:

The development of adventitious bud techniques *in vivo* and *in vitro* for mutation breeding.

Beschrijving van de resultaten:

The use of the adventitious bud technique, viz. the development of adventitious plantlets on detached leaves, has proven to be a powerful tool in mutation breeding because usually a high percentage of solid mutants is obtained. This has been demonstrated in a number of crops such as *Achimenes*, *Streptocarpus* and others. This aspect of the project (a) is being continued, though on a somewhat smaller scale, as a demonstration for (potential) users, whereby the combined use of radiation, colchicine-treatment and so-called conventional breeding methods is emphasized. During this work at times mutants with commercial value are produced (Broertjes).

The second and increasingly important part of the project (b) is the development of the method in crops which do not spontaneously produce adventitious buds. Besides *in vivo* techniques also *in vitro* methods are studied since some of the latter also look promising, either as a tool in plant breeding or as a (fast) propagation method (Roest and Bokelmann). As soon as part (b) has produced results, it will be investigated whether or not artificially induced adventitious shoots of the method(s) in question develop from one cell and consequently are or are not of interest for mutation breeding (c) (Broertjes and Roest).

a. In 1971 a number of mutants were produced of the white flowering *Streptocarpus* cv. Maassen's White (a spontaneous mutant of "Constant Nymph"). Besides, a number of autotetraploids were produced by colchicine-treatment (using the adventitious bud technique) of "Maassen's White" as well as of mutant 7111 (a mutant of "Maassen's White" with longer flower stalks and larger number of flowers). All were propagated clonally and compared with each other in 1972. During a final test in June 1973 none of the mutants proved to be of commercial value. One of the autotetraploid forms of mutant 7111, having large white flowers and very sturdy flower stalks, however, was awarded a Certificate of Merit and has been released to the trade under the name "Albatros". This demonstrates that a combination of radiation, colchicine-treatment and the use of the adventitious bud technique can produce commercial results within a relatively short period.

In *Achimenes* a few mutants, produced earlier, were selected in 1972 for final judgement in 1973. Two of them were awarded a Certificate of Merit, namely a mutant with a very compact growth habit, even under sub-optimal greenhouse conditions. It is, moreover, extremely free flowering. This very promising mutant will be commercialized as "Cupido". A second mutant has large flowers and a less condensed growth habit; its name is "Orion". The pink-flowering *Achimenes* cultivars are increasingly attracting interest, partly because better forms have been introduced recently (more condensed growth habit, free flowering, also under less optimal conditions). The flower size, however, is not sufficient. A combined use of colchicine-treatment and radiation, together with the adventitious bud technique, seems to be the appropriate way to improve these cultivars. To this end leaves of three of the best cultivars, namely "Tarantella", "Repelsteeltje" and "Little Beauty" have been subjected to colchicine-treatment. A number of (very attractive) autotetraploids have been produced of all three cultivars. They are being propagated clonally and will be or are already irradiated to produce mutants at the tetraploid level (with large(r) flowers and more intense flower colours). This again is to demonstrate the usefulness of combining the above mentioned techniques. Two of the many *Kalanchoë* mutants, obtained after irradiation of leaves, were selected early 1973, to be propagated for a final test. One of the mutants had an extremely bright red flower colour, even when grown during December and January (see also publication by Broertjes and Leffring). *Muscari*, *Endymion* and *Scilla*, three species belonging to the *Liliaceae* can be reproduced very readily via the adventitious bud technique. Thousands of adventitious plantlets of *Muscari* flowered and many mutants were observed. Although most mutants were only slightly different from the control, we got the impression that none of them showed chimerism. Twenty of the most striking mutants will be propagated to finally test whether or not adventitious plantlets also ultimately originate from one cell. At the same time cytological-histological observations are being carried out. *Scilla* did, so far, not produce mutants; *Endymion* did not yet flower.

b. The adventitious bud formation of *Chrysanthemum morifolium* Ram. cultivars Bravo and Super Yellow was investigated *in vivo* and *in vitro*. For that purpose vegetative and generative stockplants were cultivated under respectively long and short day conditions.

In vivo, leaves of both cultivars (using 9 leaves per shoot and designating the top leaf as position 1) were excised and distributed over the treatments.

Adventitious roots arise directly from the base of the petiole; the first roots appear after 9 days and 3 weeks after leaf detachment all the leaves are rooted.

Adventitious shoots so far exclusively develop on leaves of cv. Bravo; usually emerging from callus at the base of the petiole within a period of 2 - 6 months after leaf excision.

It was observed that leaves of some plants regenerated more adventitious shoots and more readily than leaves of other plants. Leaves of the positions 1, 2, 8 and 9 showed a higher regeneration ability than leaves of the intermediate positions. Adventitious shoot formation was stimulated by a combined treatment with 1% β -indolebutyric acid (on talc basis) after 0 weeks and 6-benzylamino purine (BA, on lanolin basis) 10^{-5} g/ml after 3 weeks. Exposure to light of the base of the petiole and the upper part of a few roots appeared to be favourable for adventitious shoot formation compared to continuous darkness (the normal procedure). In the former situation, occasionally, the shoots did not originate from the base of the petiole but from roots.

In vitro, both cultivars regenerated adventitious shoots on explants of the leaf, the flower-stalk and the flower-head (capitulum). The cv. Super Yellow always initiated more shoots than comparable explants of the cv. Bravo. The application of the medium of Murashige and Skoog considerably improved the formation of adventitious shoots. The addition of a cytokinin (BA) and a sugar (sucrose) proved to be of essential significance and furthermore the initiation of adventitious shoots was enhanced by using explants as young as possible.

Leaf-explants regenerate shoots via callus usually at the base of the petiole 3 weeks after incubation and explants of the flower-stalk yield a direct regeneration over the whole length of the segment and the first adventitious shoots emerge 10 days after incubation.

Shoots arise on capitulum-explants directly from the receptacle or indirectly via callus 2 - 3 weeks after incubation. The development of the shoots was increased when the disc and ray florets and upper involucre bracts were nearly completely cut off. Shoots with a length of at least 1 cm were isolated from the capitulum and the basal end of the shoot was treated with 1% β -indoleacetic acid (on talc basis). After a subsequent transfer of the shoot to unsterilized soil (a mixture of leaf mould and sand) adventitious root formation was induced and complete plantlets were produced a few months after incubation. Approximately a half year after incubation uniform flowering plants were obtained.

c. The usefulness of the adventitious bud technique, using detached leaves, was tested with *Chrysanthemum morifolium* Ram cv. Bravo. Usually a very restricted percentage of the leaves produce adventitious shoots, but in one experiment, for reasons unknown, over 50% of the leaves produced 1 - 3 shoots. Since the leaves were irradiated with 500 rad X-rays it was possible to analyse whether or not solid mutants can be obtained by this method. The preliminary results are in short that the majority of the plants, carrying a visible mutation, are chimeric of structure and that, consequently, the production of adventitious shoots via callus tissue (formed at the base of the petioles) is less useful than the formation of adventitious buds from epidermal tissue (as is demonstrated with *Achimenes*, *Begonia*, *Streptocarpus*, etc.).

Publications 1973.

BROERTJES, C. *Achimenes* en *Streptocarpus*. Nieuwe variëteiten door bestraling en colchicine-behandeling. Vakbl. Bloem. 28 (28) 11 (1973).

BROERTJES, C. The production of polyploids using the adventitious bud technique. FAO/IAEA/Eucarpia Conf. on Mutations and Polyploidy, Bari (Italy), Oct. 1972 (in press) (1974).

BROERTJES, C. and L. LEFFRING. Mutation breeding of *Kalanchoë*. Euphytica 21: 415-424 (1972).

ROEST, S. and G.S. BOKELMANN. Vegetative propagation of *Chrysanthemum cinerariaefolium* *in vitro*. Scientia Horticulturae 1, 120-122 (1973).

Resultaten van het project No. 11

Hoofd van het team en wetenschappelijke medewerkers:

A. Ringoet en G. Merkx.

Titel van het project: Research on the nature of induced and spontaneous mutations.

Beschrijving van de resultaten:

Further studies on gene instability of chlorophyll mutants in tomato (Lycopersicon esculentum Mill) plants

1. Localization of mutants C₆ and C₁₂

In 1973, the phenotype, seed and fruit production in the F₁ of crosses between these mutants and a series of different trisomics have been analyzed. A certain number of plants with aberrant numbers of chromosomes have been selected for further observation.

2. Localization of mutant C₁₁ using marker lines

During this study, which in general confirmed last year's results, it was shown, however, that Butler 16 'marker bu/bu' (bushy) is not homozygous for this characteristic.

3. Induction of primary monosomic for chromosome 5

This induction had been realized in Lycopersicon esculentum Mill by pollen-irradiation with thermal neutrons. This experiment has been repeated using Butler 17 'marker wt' (wilty leaves), which line presents the advantage that point-mutations and monosomics are phenotypically detectable. Twenty-four plants among 772, resulting from 1086 seeds of a crossing Butler 17 ♀ x irradiated pollen of Moneymaker, were selected for cytological observation. No monosomics were found, but 4 plants probably present point-mutations.

Publications

ECOCHARD, R. and MERKX, G.: A primary monosomic for chromosome 5 in the tomato. *Caryologia* 25, 531-536 (1972).

Resultaten van het project No. 12.

Hoofd van het team en wetenschappelijke medewerkers:

A.J.G. van Gestel

Titel van het project: Induction of self-compatibility in dihaploid *Solanum tuberosum* L.

Beschrijving van de resultaten:

After γ -irradiation and self-pollination of a self-incompatible dihaploid *Solanum tuberosum* L. clone a number of berries with seeds were obtained.

In the I_1 -progenies of the control no self-compatibility was present. Half of the offspring displayed the self-compatibility character. However, the self-compatibility character was not expressed in all the flowers of a plant and showed a large variation throughout the year.

In the summer of 1973 the I_1 and some I_2 progenies have been tested. They displayed a similar pattern as was found in 1972. The results obtained, seem to indicate that the self-compatibility character is radio-induced (no self-compatibility in the control-series) and of a genetic nature (self-compatibility present in the I_2 and I_2). No permanent changes on the S-locus have been induced (no pollen and stylar part mutations are segregating in the progenies studied). Probably minor genes are involved.

Resultaten van het project No. 13.

Hoofd van het team en wetenschappelijke medewerkers:

A.J.G. van Gastel

Titel van het project: Spontaneous and induced mutations at the S-locus; a comparative analysis on the origin and nature of constructive and negative mutations.

Beschrijving van de resultaten:

Mutation spectrum analysis at the S-locus of *Nicotiana alata* Link and Otto.

The aim of the experiments is the comparison of self-compatibility mutations induced by mutagenic treatments.

- Pollenmother cell (P.M.C.) treatment.

P.M.C.'s of *Nicotiana alata* Link and Otto have been treated with γ -rays, X-rays, fast neutrons and with EMS. A publication of the results obtained after chronic γ -rays is in press and a publication on the results of X-rays and fast neutrons is in preparation. General conclusions (1) Chronic γ -irradiation is very effective for inducing seed-set upon selfing. (2) Chronic γ -irradiation and EMS-treatment are not capable to induce self-compatibility mutations. (3) Both X-rays (acute) and fast neutrons (acute) are able to induce self-compatibility mutations. (4) The mutation spectrum after X-rays is the same as the mutation spectrum found after fast neutron treatment. (5) Fast neutrons induce a higher number of self-compatibility mutations than X rays. (6) Chronic γ -rays, X-rays, fast neutrons and EMS did not induce constructive mutations.

- Seed treatment

Seeds of *Nicotiana alata* Link and Otto have been treated with EMS.

Neither constructive nor negative mutations have been detected.

- Leaf-treatment

The induction of mutations at the S-locus by means of leaf-treatment with X-rays, EMS, UV and fast-neutrons did not yield constructive or negative mutations in the progeny derived from the treated leaves.

The analysis of the factors and mechanisms involved in the generation of new S-alleles. (test-species: *Lycopersicon peruvianum* Mill).

To test the theory of Edström that constructive mutations are due to reactivation of allelic copies previously stored during out-

breeding, several S_1S_2 - plants (selected from the crosses $S_1S_6 \times S_2S_6$; $S_1S_6 \times S_2S_7$; $S_1S_7 \times S_2S_6$; $S_1S_7 \times S_2S_7$) have been inbred via hormone treatment and heatshocks. The first seeds have been obtained and it is hoped that a new specificity will be found, which is the same as the specificity which was stored during previous outbreeding.

This project is part of a common programme with the Casaccia in Italy (see report elaborated by the CNEN).

Publications 1973

GASTEL, A.J.G. VAN, Incompatibility in higher plants. Report at the Mutation Breeding Contact Group Meeting, Grünbach. (1973).

GASTEL, A.J.G. VAN, BEEK, M.A. and VEEN J.H. VAN DER. The effects of EMS-treatment of seeds on self-incompatibility in *Nicotiana glauca*. Incompatibility Newsletter 2: 62-66 (1973).

GASTEL, A.J.G. VAN and NETTANCOURT, D. DE. The effects of different mutagens on self-incompatibility in *Nicotiana glauca* Link and Otto. I. Chronic gamma irradiation. Radiation Botany (in press).

Resultaten van het project No. 14

Hoofd van het team en wetenschappelijke medewerkers:

A.J.G. van Gestel

Titel van het project: Establishment of linkage relationships with the S-locus of self-incompatible plants and identification of the S-bearing chromosomes

Beschrijving van de resultaten:

Establishment of linkage relationships in *Nicotiana glauca* Link and Otto.

The aim is to induce marker mutations on a large scale. The induced mutations will be tested for linkage with the S-locus. This approach may permit early identification of S-genotypes. Up to now detached leaves have been treated with X-rays, E.M.S. U.V. and fast neutrons.

Only three morphological mutants (after X-rays), which did not transmit their phenotype to the next generation have been recorded.

These negative results might be due to very low mutation frequencies, the small amount of plants and the homozygosity of the material.

In case the material is homozygous dominant the induced mutations can only be detected in the bud-selfed progenies. Therefore, plants derived from treated leaves have been bud-pollinated. The resulting seeds were sown and selection for marker mutations was carried out in the seedling stage.

Almost all progenies obtained from the fast neutron experiment have been analyzed and not a single mutation seemed to be segregating. Therefore, no visible mutations ($AA \rightarrow Aa$, $Aa \rightarrow aa$) have been induced. The absence of mutations still might be due to the small number of plants analysed or to homozygous recessive material.

Identification of the S-bearing chromosome

According to the competition theory plants, which are trisomic for the S-bearing chromosome, are self-compatible. Via cytological analyses of trisomic plants we try to identify the S-bearing chromosome. Trisomic plants can be expected in the progeny of triploid *N. glauca* x diploid *N. glauca*. Thirty plants (out of 200) have been tested for self-compatibility. Two plants seemed to be slightly self-compatible and may, therefore, have an additional chromosome on which the S-locus is located.

This project is part of a common programme with the Casaccia in Italy (see report elaborated by the CNEN).

Resultaten van het project No. 15

Hoofd van het team en wetenschappelijke medewerkers:

G. Bredemeijer and F.A. Hoekstra

Titel van het project: Biochemical aspects of self-incompatibility in *Lycopersicon peruvianum* Mill and *Nicotiana alata* Link and Otto.

Beschrijving van de resultaten:

Changes in peroxidase isoenzyme patterns of unpollinated, self-pollinated and cross-pollinated styles of *Nicotiana alata* were investigated in order to obtain information which could be used to prove or to reject Pandey's hypothesis that peroxidase is involved in the formation of the incompatibility barrier.

Compatible growing pollen tubes need almost four days (progamic phase) to reach the ovary. The differences in peroxidase isoenzyme composition of the whole style after self- and cross-pollination were rather small during the progamic phase (see fig. 1) and did not support the idea of PANDEY (1967) that a new peroxidase should be formed in self-pollinated styles which is supposed to be active in the incompatibility reaction. We did not find a new peroxidase which was specific for self-pollinated styles. The new peroxidase (No. 13) in self-pollinated styles also occurred in cross-pollinated styles. On the contrary the new peroxidase No. 8 only appeared in cross-pollinated styles. On the one hand it is possible that the activity of peroxidase 8 is necessary for continuation of pollen tube growth. On the other hand, however, the differences in peroxidase isoenzyme activities after self- and cross-pollination might be a consequence rather than a prerequisite of differences between compatible and incompatible pollen tube growth. Up to now this question remained unanswered.

When the compatible pollen tubes have reached the ovary after about 4 days the activities of most peroxidase isoenzymes show a striking increase (see t = 117 hrs) in contrast with self-pollinated styles in which the peroxidase activity remains more or less the same. In the latter case the pollen tubes do not reach the ovary. When isolated styles were used instead of detached flowers several peroxidase isoenzymes do not increase in activity after cross-pollination. Apparently the increase of these isoenzymes is caused by activation of the growth centre in the ovary which would regulate the enzyme activities of the flower.

Respiratory and physiological properties of bi- and trinucleate pollen.

In humid air of 97% relative humidity, binucleate pollen have a low respiration rate over a long period, and their viability can be maintained to a high degree. Trinucleate Compositae- and Gramineae-pollen on the contrary, have a high rate of respiration during a short period, and a quick loss in vitality.

In order to gain insight into the origin of these differences, pollen of several plant species have been examined. Among these are *Nicotiana glauca* Link et Otto, *Typha latifolia* L. and *Narcissus poeticus* L, as representants for the binucleate type, and *Aster tripolium* L., *Cosmos bipinnatus* Cav., *Tanacetum vulgare* L. and *Zea mays* L. for the trinucleate type. For the experiments, over 120 portions of pollen have been collected under controlled conditions. After 20 hours of drying over sodium hydroxide pellets at 5 °C, they were kept under deepfreeze circumstances in closed vessels. In October, the samples have been tested for their germination ability and respiratory properties at 97% R.H. and 30 °C.

Within the samples of one species with binucleate grains, the variation was very limited. In general, the rate of the binucleate grains ranges from 0,060 to 0,120 $\mu\text{mol CO}_2/\text{mg pollen}/\text{hour}$.

Within the samples of one species with trinucleate grains, however, considerable differences in respiration rate could be established. Artificially, this phenomenon could be simulated: for example *Cosmos bipinnatus* pollen can respire for 7 hours at a rate of 0,45 $\mu\text{mol CO}_2/\text{mg}/\text{hour}$. After incubation for 1½ hours, followed by quick desiccation over NaOH-pellets at 5 °C, reincubated pollen gave a reduced respiration rate of 0,20 $\mu\text{mol CO}_2/\text{mg}/\text{hour}$, during 5 hours. Preliminary incubation for 3 hours, followed by quick desiccation in the cold, totally blocked the respiration ability of the re-incubated material. It was observed, that retarded shedding of the ripe trinucleate pollen, reduced the germination ability and respiration rate. For this reason, attention has to be paid to the homogeneity of the trinucleate pollen sample, when required for biochemical purposes.

The respiration process of both types of pollen appeared not easily affected by X- and γ -irradiation. Low doses did not stimulate, nor reduce the respiration rate. A decrease of the rate and duration of respiration was seen with the trinucleate *Cosmos bipinnatus* pollen at doses, starting from 350 Krad ^{60}Co γ -rays up to 900 Krad. The binucleate *Narcissus poeticus* pollen showed an increase in the respiration rate at a dosis of 450 Krad, until it was doubled at 650 Krad.

This increase will presumably be due to membrane damage. The duration of this respiration decreased, starting from 450 Krad. Such high doses deteriorate the DNA and RNA of cells of higher plants irreparable. De novo synthesis of proteins will be disturbed entirely. Still the binucleate type did not show a decrease in the respiration rate. The normally low respiratory activity of the binucleate types therefore, has no relation with a slow De novo synthesis of proteins. Both types of pollen have their respiratory system present at the moment of shedding.

Another factor in relation to the respiration rate of binucleate pollen, that might be limiting, is the rate of uptake of water vapour. The uptake of tritiated water vapour gave practically no differences in the accumulation of radioactivity among bi- and trinucleate types of pollen. The estimated amounts of water, that have been taken up, appeared to be in accordance with the measured increase in weight of the pollen mass. Initially the uptake of water vapour is very rapid. Eventually, both types reached nearly a doubling of their initial weight. This clearly demonstrates, that the observed differences in the respiration rate can not be the result of supposed differences in the uptake of water vapour.

More detailed studies will be required, concerning the nature of the available substrates and the mitochondrial activity in the course of the respiration process.

Publications - 1973

BREDEMEIJER, G.M.M. Peroxidase activities and peroxidase isoenzyme patterns during growth and senescence of the unpollinated style and corolla of tobacco plants.

Acta Bot. Neerl. 22: 40-48 (1973).

BREDEMEIJER, G.M.M. Peroxidases in un-, self-, and cross-pollinated tobacco styles.

Incompatibility Newsletter 3: 55-57 (1973).

HOEKSTRA, F.A. In vitro germination of *Compositae* pollen.

Incompatibility Newsletter No. 3: 47 (1973).

HOEKSTRA, F.A. Exogenous factors, influencing pollen viability of *Chrysanthemum cinerariaefolium* Vis.

Incompatibility Newsletter No. 3: 49 (1973).

HOEKSTRA, F.A. Respiration and vitality of bi- and trinucleate pollen.

Incompatibility Newsletter No. 3: 52 (1973).

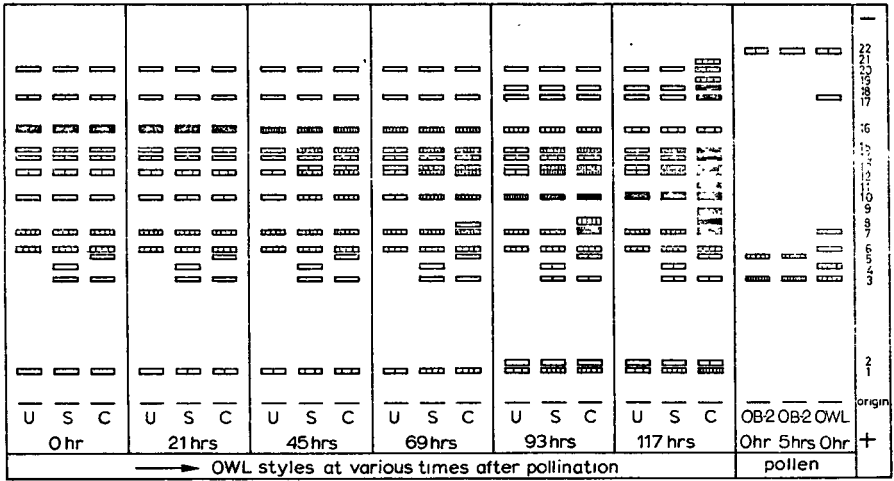

fig. 1. Diagram of the electrophoretic patterns of peroxidases from un- (u), self- (s) and cross- (c) pollinated *Nicotiana alata* styles at various times after pollination and from germinated OB-2 (5 hrs) and ungerminated OB-2 and OWL pollen (0 hrs). The degree of hatching approximates the staining intensity. No hatching means that the bands on the starch gels were just visible.

Resultaten van het project No. 16

Hoofd van het team en wetenschappelijke medewerkers:

H.M.G. Groot, C. Broertjes, K.H. Chadwick, H.P. Leenhouts, K.J. Puite.

Titel van het project: The radiation dose-fractionation effect
in *Saintpaulia*.

Beschrijving van de resultaten:

Leaves of *Saintpaulia ionantha* H. Wendl.c.v. Utrecht show, when exposed to a low initial irradiation dose, a higher radioresistance against a second dose, given 8 - 24 hours after the first dose, in comparison to untreated leaves. This effect has been observed with X-rays as well as with fast neutrons. A few possibilities about the origin of this dose-fractionation effect, such as changes in metabolic activity of the leaves, transport of a radiation-induced protective agent, were investigated. So far, only X-rays have been used.

Concerning the metabolic activity of the leaves special attention was paid to the influence of temperature. Different temperature-treatments (6 , 13 , 20 and 29 °C) have been applied to detached leaves in sealed polyethylene bags, 24 hours before the first irradiation, during the 8-h time interval between irradiations and 24 hours after the second irradiation. In addition, similar treatments were applied exclusively during the 24-h time interval between the two irradiations. No fractionation effect was observed at 6 °C, this temperature proved to be too low, as there were (some) symptoms of cold damage. Differences in reaction at the temperature-treatments of 13, 20 and 29 °C were observed, especially in the second experiment (temperature-treatment during time interval only), in which the greatest fractionation effect was obtained at 13 °C. These differences might, however, be related to time interval: it is possible that the time interval of 24 hours was optimum for 13 °C and not for 20 and 29 °C. An experiment was carried out in which a range of intervals (1 - 4 - 7 - 10 days) at two temperatures (10 and 20 °C) was investigated. The dose-fractionation effect was highest at the 24-h interval and decreased with longer time intervals for both temperatures, however, faster for 20 °C (no fractionation effect at 7-days interval) than for 10 °C (still a small fractionation effect at 7-days interval). Noteworthy was the relatively higher dose-fractionation effect at high doses in comparison to medium doses. Considering the results

of this experiment it might well be, that in the range of 0 - 4 days not enough data were present. It was impossible to conclude from the data available, whether or not the optimum time interval (interval resulting in the highest dose-fractionation effect) was different for the two temperature-treatments. Therefore, an experiment was carried out in which time intervals of 24-48-72-96 hours were chosen for the treatment of 10 °C and of 8-16-24-96 hours for the treatment of 20 °C. Results of this experiment are not yet available.

Attention was paid as well to the influence of gas environment upon the dose-fractionation effect. An experiment, investigating the influence of the gas environment inside sealed or open polyethylene bags, in which the leaves normally are irradiated and stored during the time interval between irradiations, resulted in a somewhat higher dose-fractionation effect for sealed as for open bags. Experiments in 1972 suggested that leaves, irradiated with 500 rad X-rays showed a somewhat higher respiratory rate (measured with the Infra Red Gas Analyser) during the first 24 hours after detaching as compared to unirradiated leaves. To see whether or not respiration is correlated in some way with the dose-fractionation effect, an (orientating) experiment was carried out, in which respiration was partly blocked, during the 8-h time interval between the two irradiations, by a CO/air mixture (in the dark). Results of this experiment cannot be presented yet.

In order to investigate whether or not transport is involved in the development of the dose-fractionation effect, petioles of leaves were irradiated with high X-ray doses, with pretreatment (8 or 24 h before) or without pretreatment of either the leaf blade or the petiole. As this experiment didn't give clear results, a more detailed experiment was carried out, of which no data are available yet.

Concerning the radiosensitivity of the leaves it was demonstrated that the time interval between detaching and irradiation was of importance: a change in radiosensitivity of the leaves after storage was observed. Leaves, irradiated 8 hours after detaching and stored during this period in sealed polyethylene bags in the dark, were less radiosensitive than leaves, irradiated immediately after detaching, whereas leaves, irradiated on the plant and detached 1 hour after irradiation, were the least radiosensitive. These results might have consequences for other experiments carried out

formerly (acute irradiated leaves were mostly irradiated directly after detaching, while leaves, exposed to fractionated irradiation, generally received the final high dose after 8 hours). This "time-effect" has been confirmed by several other experiments. There are indications that the radiosensitivity of the leaves decreases with a longer time interval between detaching and irradiation up to a 24-h interval. Data, giving the radiosensitivity at longer time intervals are inconclusive. Experiments have been started to investigate this "time-effect" more thoroughly. Another fact, demonstrated by several experiments, is the stimulation of the production of adventitious plantlets at the base of the leaf petiole by low doses of radiation (1-3 krad). Whether this stimulation is correlated in some way to the dose-fractionation effect is unknown. This idea, however, was not supported by a low-temperature treatment (6 °C during a 24-h time interval), resulting in a stimulation without a dose-fractionation effect. The stimulation as such seems to be a fact, it seems to be independent of wounding-effects (caused by detaching the leaves of the plant), since the stimulation was observed both when the leaves were irradiated after detaching and when the leaves were irradiated on the plant and detached several hours (up to 24 hours) later. Finally it is being investigated whether or not the determination of adventitious plantlets at the base of the leaf petiole at an earlier developmental stage gives results comparable to the normal production data (obtained 6 months after planting).

Resultaten van het project No. 18.

Hoofd van het team en wetenschappelijke medewerkers:

C. Broertjes.

Titel van het project: Organization and coordination of applied
mutation breeding

Beschrijving van de resultaten:

During 1973 again many scientist and commercial plant breeders, mainly from the Netherlands but also from other countries, used the service of the Association: general information about the possibilities of mutation breeding, requests for literature, and irradiation of plant material. It is noteworthy that an increasing number of the persons contacting us, are academically trained plant breeders, either at Institutes or engaged at a commercial plant breeding station. This certainly will improve the scientific basis of the projects and may thus lead faster to positive results.

Thirteen new projects were studied in 1973, namely with cultivars of Alstroemia, Amaryllus, Arum, Begonia, Dianthus, Chrysanthemum, Euphorbia, Gerbera, Gladiolus, Kalanchoé, Lycopersicon esculentum L. and Saintpaulia, all but one being vegetatively propagated ornamentals. In a few of the above listed species use is made of the adventitious bud technique (Begonia, Kalanchoé, Saintpaulia). In Gerbera a propagation method has been developed in which very young buds seem to produce shoots. In Alstroemia almost exclusively solid mutants are obtained after irradiation of actively growing rhizomes of young plants, unforeseen but advantageous circumstance which speeded up the breeding programme of the crop.

In 1973 several mutant varieties were released to the trade, such as Alstroemia c.v.s. Harmony, Rosita Yellow, Sun and Harlequin flower colour mutants of various cultivars (partly: Broertjes Verboom, 1974), Achimenes c.v. Cupido, a very compact and free flowering mutant of 'Paul Arnold' and 'Orion', a large flowered mutant of the same variety. Of Chrysanthemum four different Yellow-flowered mutants of the pink flowering cv. Beamsville Pink, were released, namely the cvs. Uncle Danny, Danny Boy, Danny's Pearl and Danny's cape. Of the Dahlia cultivar Andries Wonder (a plant with a unique flower form which resembles that of a Chrysant), three flower colour mutants were released, namely 'Maarse's Purple Wonder', 'Maarse's Red Brown Wonder' and 'Maarse's Golden Wonder' (this

is a typical example, that by mutation breeding, very rapidly genetic variation can be obtained without changing the unique genotype). Of Streptocarpus two mutants were released, namely c.v. Snow-white, a dwarfy mutant of cv. Maassens White and cv. Albatros an autotetraploid of number 7111, a mutant of 'Maassens White'. (The autotetraploid was obtained by a combined usage of the advertitions bud technique and colchicine). Of onion, two selections from irradiated material were released namely 'Compas' a hard onion with a tough skin which is less susceptible to neckrot (Botrytus alliæ Munn.), and 'Brunette', which is early, moreover, and higher yielding.

Furthermore, a mutant of Dictyilis Glomerata (Cocksfoot or Orchardgrass), obtained in 1960, was entered into the list of varieties in 1972; its main advantage seems to be a lower silicic acid content which makes it more attractive for cattle.

Promising results were reported in the same or in other crops and it is expected that mutants will soon be released in Alstroemenia, Begonia, Chrysanthemum, Lilium, Kalanctoë, onion and Poa.

Attempts have been made to contact plant breeders in the new Common Market Countries. Some were invited to join the Mutation Breeding Contact Group. So far, one scientist from Risø, Denmark joined the 1973-meeting, held from 6-9 November at Grünback (Germany); others showed their interest (see external report).

Resultaten van het project No. 19

Hoofd van het team en wetenschappelijke medewerkers:

S.C.E. Romkes

Titel van het project: Influence of irradiated medium on micro-organisms.

Uptake and localization of cytotoxic compounds,
induced by irradiation of food.

Beschrijving van de resultaten:

Irradiated glucose is inhibitory to growth and in some cases even cytotoxic to micro-organisms.

The mechanism of this cytotoxic effect is not known.

Insight into this mechanism could prove to be valuable in the field of food preservation by irradiation.

In the preceding year some hundreds of strains have been isolated from fish, and have been exposed to an irradiated synthetic medium, or to a synthetic medium containing irradiated glucose. Irradiated-medium sensitive strains have been selected.

This year several more sensitive strains have been isolated.

The selected strains were grown in chemically defined liquid media under conditions of controlled pH, temperature and aeration in a fermentor

By passing sensitive strains through irradiated medium and repeating the process with the surviving cells at higher doses of irradiation, derivative strains were obtained, that were far less sensitive to irradiated medium, although their growthrate in irradiating medium would be slightly less than that of the original strain in the non-irradiated medium (Fig. 1).

Growth curves for sensitive and nonsensitive strains were recorded for several media.

In a few instances a reduced uptake of glucose has been measured, but it has not been established whether this was a consequence of inhibited growth or of blocked uptake mechanisms.

In contrast to earlier findings irradiated glucose solution could without subsequent autoclaving, be sufficient to retard or stop growth in the most sensitive of the selected strains of Micrococci. In several cases it has been found that irradiation of the complete synthetic medium would inhibit growth, whereas separate irradiation of glucose alone did not.

In two cases, both yeasts, this has been shown due to radiation breakdown of vitamins. In one case addition of riboflavin could

reverse this inhibition of growth.

Cells of one sensitive strain and its adapted counterpart are being grown in larger amounts in an orbital incubator in order to accumulate starting material for biochemical analysis.

It was noted however, that the adapted strain sometimes reverted to the original sensitive state.

Ribosomal protein compositions for both strains are being compared by means of the Two-Dimensional electrophoresis method of Kaltschmidt. Preliminary results seem to show a difference in these protein patterns.

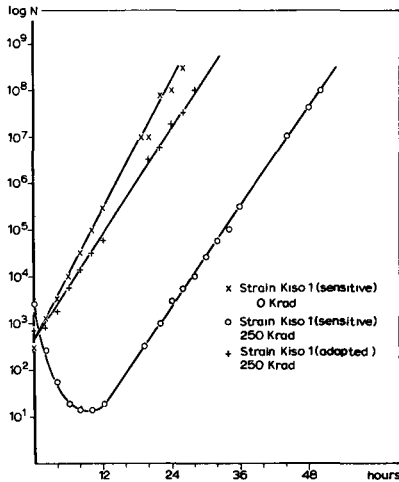

fig. 1. Adaptation to irradiated glucose

Strain Kiso 1, grown in synthetic medium, with glucose irradiated at 250 Krad

- x 0 Krad
- 250 Krad
- 250 Krad, after two previous passes through glucose irradiated at 100 Krad.
- + 250 Krad, fully adapted

Resultaten van het project No. 20

Hoofd van het team en wetenschappelijke medewerkers:

H. Stegeman

Titel van het project: The radiation and heat resistance of bacterial spores.

Beschrijving van de resultaten:

Metal content and radiation resistance.

Metals play important roles in formation and in final properties of bacterial spores. The aim of this study is to get more basic information about the role of metals in relation to the radiation resistance. The experiments concerned this year the influence of calcium and manganese concentration in the sporulation medium on the calcium and manganese content of spores of a mesophilic strain and their effect on the resistance to a radiation and heat treatment.

Spores of *Bacillus subtilis* ATCC 6633 were cultivated in a chemically defined and in a complex liquid sporulation medium with different calcium/manganese contents. The manganese content of spores was determined by neutron activation analysis and the calcium content with atomic absorption analysis (cooperation with P. Poelstra and N.v.d.Klugt). Radiation was from a ^{60}Co source which irradiated spores in water at a dose rate of about 0,9 Mrad/h at about 20°C. Table 1 shows the influence of the calcium level into a synthetic sporulation medium containing 2,5 ppm manganese on the metal content of the spores and on the radiation resistance. Increasing the calcium concentration in the sporulation medium reduced the manganese content of the spores. There was an optimum concentration for maximum calcium accumulation. The radiation resistance was significantly ($P = 0.05$) higher for spores formed in media containing minimal levels of calcium. The heat resistance increased by addition of calcium up to a level of 50 ppm calcium and decreased at higher calcium concentration.

Tables 2 and 3 show that the incorporation of manganese was greater at higher manganese concentration in the synthetic and complex sporulation medium. According to table 1 spores with high accumulation of manganese were more resistant to irradiation than spores with low or normal manganese level. The spores produced in media with different manganese concentrations varied slightly in heat sensitivity. Spores formed in the synthetic medium were more heat resistant than spores formed in the complex medium.

Role of metal content in radiosensitization

Spores of *Bacillus subtilis* ATCC 6633, cultivated in a synthetic sporulation medium with 1 ppm Ca were inactivated by gamma irradiation more effectively in the presence of 1 mM KJ_3O_3 than in the absence of KJ_3O_3 . The radiation of spores cultivated in the same sporulation medium with 50 ppm Ca was unaffected by potassiumiodate.

These results appear to be in accordance with the suggested inactivation mechanism in the literature by γ -irradiation in the presence of iodate.

Activation of irradiated spores

Heating of spore suspensions of some bacterial species result in an increased viable colony count. This process of "Conditioning the spore to germination" has been called "activation". The activated spores retains most of the spore properties and the process of activation is in most cases reversible. Heat activation is the simplest method of activation, but other treatments can replace the heat effect. For example, exposure to low pH or Na-DPA. The aim of these experiments was to study the activating effect on irradiated spores. Spores of a rough variant of *B. stearothermophilus* strain 1518, obtained from M.L. Fields (University of Missouri, U.S.A.) were produced by incubation for two days at 55°C on nutrient agar containing 1 ppm manganese. Microscopic examination with a counting chamber showed that 5% or less of the unheated spores germinated and gave colonies. Optimal heat activation and activation by exposure to low pH resulted approximately in a 8-fold colony count; exposure to Na-DPA in about 18-fold colony count.

Figure 1 shows that activation of irradiated spores by exposure to low pH is possible. Similar results were obtained by spores activated by exposure to Na-DPA. Heat activation of irradiated spores resulted first in an increased viable colony count, but at higher irradiation doses the inactivation of heated spores was greater than non-activated spores (see figure 2).

Table 1 - Radiation resistance and metal content of spores formed in a chemically defined sporulation medium with 2,5 ppm manganese and varied calcium levels.

Ca ²⁺ in medium (ppm)	Ca ²⁺ in spores (% dry wt)	Mn ²⁺ in spores (% dry wt)	D ₁₀ -value (krad) (95% confidence limits)
1	0.51	1.15	187 ± 10
5	0.91	0.43	170 ± 4
10	1.52	0.32	162 ± 10
25	2.42	0.19	141 ± 5
50	5.77	0.23	140 ± 4
100	5.55	0.23	144 ± 7
150	3.58	0.08	143 ± 3

Table 2 - Radiation resistance and metal content of spores formed in a chemically defined sporulation medium with 50 ppm calcium and varied manganese levels.

Mn ²⁺ in medium (ppm)	Ca ²⁺ in spores (% dry wt)	Mn ²⁺ in spores (% dry wt)	D ₁₀ -value (krad) (95% confidence limits)
0.05	6.73	0.009	139 ± 4
0.1	5.34	0.01	137 ± 4
1	4.18	0.08	140 ± 4
2.5	5.77	0.23	140 ± 4
10	5.32	1.29	150 ± 4

Table 3 - Radiation resistance and metal content of spores formed in a complex sporulation medium with 60 ppm calcium and varied manganese levels.

Mn ²⁺ in medium (ppm)	Ca ²⁺ in spores (% dry wt)	Mn ²⁺ in spores (% dry wt)	D ₁₀ -value (krad) (95% confidence limits)
0.05	3.88	0.008	146 ± 7
0.1	2.87	0.007	152 ± 6
1	2.45	0.09	153 ± 6
10	2.99	0.63	173 ± 7

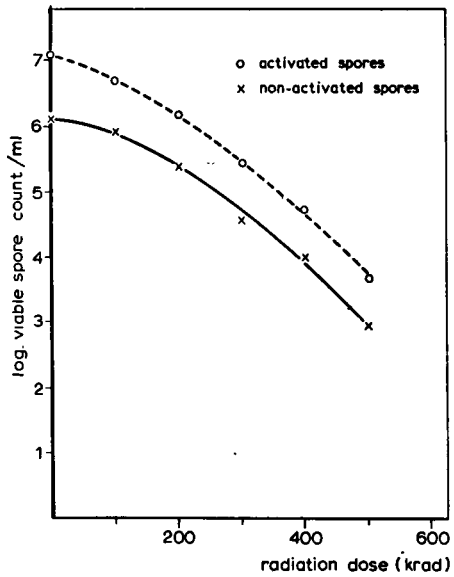

fig. 1. Effect of low pH activation on the survival of irradiated spores.

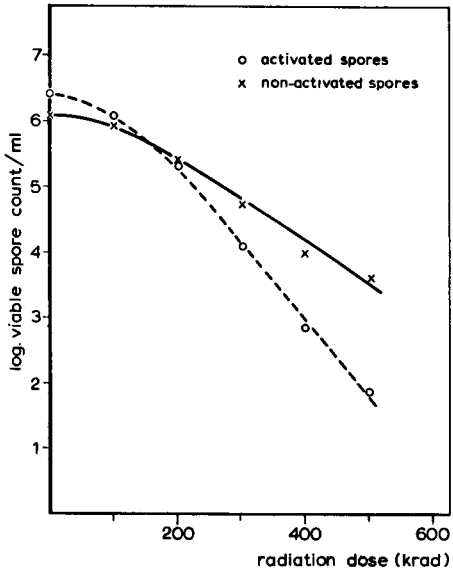

fig. 2. Effect of heat activation on the survival of irradiated spores.

Resultaten van het project No. 21

Hoofd van het team en wetenschappelijke medewerkers: J.G.van Kooij

Titel van het project: The influence of environmental factors on the radiation resistance of microorganisms.

The influence of the wateractivity of the medium.

Beschrijving van de resultaten

All the experimental work was devoted to the development of a model, which is suitable for the study of the influence of wateractivity on the radiationresistance of microorganisms. The model was tested primarily on its suitability for maintaining a high survival for microorganisms to be cultivated on it during the experimental period. In order to minimize possible effects of the model per se on the microorganism as the result of irradiation, we elaborated solely on models made up from solids, which show a high degree of radiation-inertness.

The following models were used:

1. Cellulose as strips of filterpaper to which bacteria are added.
- 2, Lyophilized powder of a 3% Carboxy-methyl-cellulose-solution(CMC) in M/15 Phosphatebuffer or in minimal medium, to which the tested bacteria are added.
3. Precipitation of bacteria on cellulose solution in M/15 Phosphate-buffer ~~or~~ in minimal medium.
4. Vacuum dried powder of a cellulose solution in M/15 Phosphate-buffer, to which the bacteria are added.

Upon preparation the wateractivity of the models is lower than 0.55. The models were conditioned to wateractivities of 0.55, 0.75 and 0.90 resp. by means of saturated salt solutions. The time needed for reaching equilibrium, and the rate of inactivation of the test-microorganism incorporated in the models were determined during conditioning. The microorganisms used throughout the experiments belonged to the Enterobacteriaceae, and they were cultured in nutrient broth, and harvested at two stages of their development viz. log. and stationary phases.

Results so far obtained indicate:

- a poor recovery of bacteria from cellulose-strips, which makes the model unsuitable,
- lyophilized powder of CMC is only suitable for the lower water-activities, because of the fact that the equilibrium-time becomes

unduly long for high wateractivities with the result of complete inactivation of the microorganisms used, The model based on precipitation of bacteria on cellulose offers some prospects; although time of conditioning is still rather long, the rate of inactivation seems acceptable.

A clear result of all experiments was that the recovery from the different models after conditioning to various wateractivities was much better for microorganisms, which were added to the models in the stationary phase of their growing cycle than for those in the logarithmic phase.

Resultaten van het project No. 24

Hoofd van het team en wetenschappelijke medewerkers: J.G. van Kooij

Titel van het project: Coordination of food irradiation research.

Beschrijving van de resultaten

1. Effects of heat (10 minutes 120°C) and 5 Mrad irradiation on vitamins in feed.

In relation to project AA 25 the decomposition of vitamins as the result of heating and irradiation was analyzed. Results for gestation-feed indicated, that sterilization by heat caused losses up to 70% for B₁ and B₆ vitamins, while radappertization reduced vitamin E by 60%. Further results demonstrated that natural sources of E-activity in feed are very sensitive to irradiation, but added λ-tocopherol was not decomposed by 5 Mrad. In order to meet the vitamin requirements of pigs the feed was enriched before treatment with appropriate amounts of those vitamins, which appeared to become deficient in the respective feeds. The investigation was carried out in cooperation with the Central Institute for Nutrition and Food Research, Zeist, The Netherlands.

2. Identification of irradiated products on basis of gross and/or specific bacteriological examinations.

In cooperation with the Agricultural University, Lab. of Food Microbiology and Food Hygiene, Wageningen, The Netherlands, investigations were carried out to evaluate the usefulness of bacteriological methods as an identification-procedure for the process of irradiation. The methods were applied to strawberries. Although many questions are still to be answered as far as microbiological detection of irradiation is concerned, there is a strong evidence, that this kind of technique is promising as a quick method for identifying irradiation in the future, especially when compared with the prospects of other sophisticated techniques.

3. Consumer-attitude studies towards irradiated food.

The practical application of food irradiation depends largely on consumer-acceptance of irradiated products. By means of opinion-polls such information can be obtained. Results of an enquiry amongst a representative group of housewives have indicated, that approx. 40% of the questionees said to have heard from this process, and their opinion about irradiation varied

from 'good idea' (10%), 'indifferent' (45%), towards 'scrupulous' (40%). An other question about willingness to participate in tests with irradiated products received a positive comment by 60% of the housewives.

4. Services to institutions on behalf of food irradiation.

The 'Spelderholt Institute for Poultry Research', Beekbergen, The Netherlands, carried on with its programme on the radiation-resistance of microorganisms relevant to poultry preservation. In cooperation with the Netherlands Institute for Dairy Research the radiation-sterilization of milkblancs was studied. The migration tests with irradiated cartons according to the 'Packaging and Food-utensils Regulation' (Food Law) was carried out by the Central Institute for Nutrition and Food Research.

The Institute for Fishery Products TNO, IJmuiden, The Netherlands continued its research programme on the radiation preservation of fishfillets and other marine products.

The irradiation of microbiological samples and/or food products used in above mentioned studies was supervised by ITAL research-workers concerned, and executed by the irradiation facilities of the Pilot Plant for Food Irradiation, Wageningen.

Resultaten van het project No. 25

Hoofd van het team en wetenschappelijke medewerkers: J.G.van Kooij

Titel van het project: Coordination of research in the field of
wholesomeness of irradiated food.

Beschrijving van de resultaten

1. Feeding tests with Groot Yorkshire sows

1.1. Production of first generation

The initial foundation stock consisting of 39 sows and 4 boars was obtained from a number of farms known for their good breeding results. In addition a group of 6 sows was kept as a reserve. The sows were upon mating divided in 3 experimental groups of 13 each, which were fed non-treated, autoclaved, and 5 Mrad irradiated feed resp. During the gestation period the sows were maintained on a dietary regime of 2 kg per day of a standard commercially prepared and pelleted gestation-feed, and water ad lib. During lactation the ration was increased to 3 kg/day. Three months after mating a final selection of the experimental groups was carried out. Four sows were identified nonpregnant; one sow died, and 6 sows were disposed of, because time of farrow was too late to fit properly in the schedule set for the production of F₁-generation.

Table 1 shows some performance data of the first offspring of the first generation raised under normal farm environment.

The results presented in table 1 are comparable to those obtained in farm practice. Postnatal and preweaning losses of the group sows fed with irradiated feed, although the losses are comparable to the group of sows fed nontreated feed, could have been less, if the number of piglets produced by one of the sows had been in the normal range. 3 of them were born dead and 6 died a few days later because of lack of viability. On the whole litter size fluctuated in all experimental groups. This is also normal for sows farrowing for the first time.

1.2. Feeding test with fattening hogs

Three groups of 30 hogs each, and corresponding with the 3 diets to be tested, were selected out of the first offspring and maintained on a ad lib. dietary hog-feed regime during the entire period of fattening, which lasted about 100 days.

Results of this experiment are not yet available.

1.3. Production of second offspring of the first generation

Postweaning piglets of the first offspring of the 3 test-rations

were selected, and housed in separate holding pens.

At the age of 7 months 3 groups consisting of 12 hogs and 8 boars each, were selected out of available material. These 3 groups will be used for the production of a second generation, of which the first offspring is expected medio 1974.

2. Rat feeding tests with diets containing irradiated compounds

A preliminary test with irradiated spices has been started to evaluate the amount of spice that can be added to the standard diet of rats without causing toxic effects. The information to be obtained from this test will provide data to set up the final protocol of a semi-chronic rat feeding test with irradiated spices.

Table 1 Some performance data of F₁-generation raised under normal farm environment.

Experimental group	number bred	of sows disposed of	nonpregnant	number of litters	number born alive
nontreated feed	13	2	1	9	76
irradiated feed	14	3	1	9 ^x)	90
autoclaved feed	12	1	2	9	74

	number born dead	number of pigs weaned	% loss up to weaning
nontreated feed	2	63	17.1
irradiated feed	10	75	16.6
autoclaved feed	5	67	9.5

x) one sow produced 18 piglets.

Resultaten van het project No. 26

Hoofd van het team en wetenschappelijke medewerkers:

D.Is. Langerak

Titel van het project: Preservation of fruits and vegetables by means of ionizing radiation.

Beschrijving van de resultaten:

In 1973 a number of experiments have been carried out with peeled potatoes, prepacked chicory, fresh and deepfrozen strawberries and further attention was also paid to the problems of discolouration caused by oxidation of polyphenols.

Peeled potatoes

Previous research in 1971 and 1972 showed that the keeping quality of peeled potatoes treated with $\text{Na}_2\text{S}_2\text{O}_5$ (sulphite) was considerably improved by irradiation (synergistic effect). However, a disadvantage of this treatment was that the taste was affected at a dipping concentration $> 0,5 \%$ and an irradiation dose > 50 krad.

In collaboration with the Netherlands Institute for Applied Home Economics Research (NITHO) the following aspects were investigated:

1. the optimal packaging
 2. the minimum dipping concentration
 3. the maximum irradiation dose.
- a. Sensory tests.

This investigation has been carried out on the basis of sensory tests by a trained panel and a consumer panel.

The experiments were carried out with the variety Bintje. The product was dipped in a $\text{Na}_2\text{S}_2\text{O}_5$ concentration of 0.25% and 0,5% and packed in polythene bags of 0,02 mm thickness, without and with 2 perforations of 2 mm ϕ . The irradiation dose was either 0- or 50 krad $\pm 10\%$. The prepacked product was stored for 4 days at 10°C .

The keeping quality of the peeled potatoes was better in the non-perforated bags than in the perforated bags. However, the taste was in the perforated bags better.

The results of the sensory test by the trained panel showed that the object 0,5% $\text{Na}_2\text{S}_2\text{O}_5$ + 50 krad received the highest score after a storage time longer than 3 days.

The consumer panel did not notice a significant difference in taste between fresh and treated potatoes (0,5% $\text{Na}_2\text{S}_2\text{O}_5$ + 50 krad).

b. Anti-oxydants.

The influence of Cystein instead of $\text{Na}_2\text{S}_2\text{O}_5$, in combination with irradiation, on colour and keeping quality of prepacked peeled potatoes was also investigated.

The product was dipped in cystein concentrations of 0,01%, 0,5% and 1% and packed in non-perforated polythene bags of 0,2 mm thickness. The irradiation doses amounted to 0- and 50 krad gamma-rays.

The results showed that Cystein in combination with irradiation gave also a synergistic effect. However, the keeping quality was shorter than with $\text{Na}_2\text{S}_2\text{O}_5$. The best object was 1% Cystein + 50 krad. No clear off-flavour was noticed.

Prepacked Chicory (Cichorum intybus)

Prepacked chicory discolours and spoils quickly after processing.

The aim of this investigation was to study the influence of packaging, irradiation and anti-oxydants on colour, keeping quality and micro-biological contamination.

Seven experiments have been carried out. All experiments were processed in the same way, only the spin-drier times were varied from 1/4 - 1 min.

As an anti-oxydant was used Cystein in concentrations of 10^{-4}M , $5 \times 10^{-4}\text{M}$, 10^{-3}M and $5 \times 10^{-3}\text{M}$. The product was packed in:

- a. polythene 0,02 mm without and with 2 perforations;
- b. polythene 0,05 mm without perforation.

The irradiation doses amounted to respectively 0- 50- and 100 krad gamma-rays.

Storage temperature: 10°C .

The cut chicory discoloured considerably faster in the perforated bags than in the non-perforated bags. A foil of 0.02 mm was more satisfactory than a foil of 0.05 mm thickness, because with the last foil the CO_2 content in the bags rose above 10%.

Packing in non-perforated bags was only possible in combination with irradiation. In the non-irradiated bags fermentation and decay occurred in consequence of a high microbial count (108/gram) and an

unfavourable gas composition.

In the beginning of the storage time, an irradiation intensified the pink discoloration. However, after 1 day this discoloration was stabilized by irradiation, while at the non-irradiated objects discoloration increased.

An irradiation dose from 50 krad onwards reduced the total viable count with 3 to 4 decimals, consequently the keeping quality was lengthened with ca. 100 %.

The influence of a Cystein treatment on the colour was inconstant. The best results were obtained when the chicory was packed in non-perforated bags and irradiated with 50 krad.

Experiments on the storability of strawberry yoghurt using irradiated strawberries.

The aim of these experiments was to find out the decimal reduction dose of the yeast flora and the maximum dose with regard to the sensory acceptability.

Because the count of yeast cells is too low for the determination of the D_{10} -value, different techniques for enhancing the number of yeast cells in strawberries have been studied.

Concerning this study the following enrichment techniques were applied

- a. on complete fruits
- b. on strawberry pulp with and without Ca-propionate (fungicide)
- c. on strawberry pulp with Ca-propionate in a fermentor
- d. on strawberry pulp + yeast and dextrose extract in an incubator at 30°C.

Results of this investigation showed that only with technique-d the number of yeast cells was sufficient and increased to 10⁸/gram in 2 days. The growth of yeast flora with the help of the other techniques was too slow.

The fresh strawberries were dipped in a solution contaminated with the above mentioned enriched yeast flora and afterwards packed in polythene bags and deepfrozen at -30°C. The strawberries were irradiated with doses of 0 - 400, 600 and 800 krad gamma-rays at -30°C and -70°C.

Results of the determination of the D_{10} -value showed that there was a difference in radio-resistance between the natural yeast flora and the enriched yeast flora.

Furthermore the D_{10} -value depended on the deepfreezing temperature and the storage time.

Sensory tests of irradiated deep-frozen strawberries were carried out in collaboration with the Netherlands Institute for Applied Home Economics Research (NITHO).

The results of these tests indicated that doses <600 krad were acceptable.

Discolouration of cut vegetables.

The discolouration of cut fruits and vegetables is probably due to the oxidation of phenols. In this oxidation reaction enzymes play an important role. Dependent on the environment (O_2 and CO_2 level) irradiation can accelerate or delay this discolouration.

To get more insight in the above mentioned problems the following aspects are investigated:

1. the correlation between discolouration and the ratio phenols and quinones (oxydation product of phenols);
 2. the effect of irradiation on enzyme-activities (Y.Tanaka).
- ad 1. The experiments have been carried out on cut chicory.

For the measurements of the phenols and the quinones the following extraction methods were compared:

- a. 1% NaCl solvent $2^{\circ}C$,
- b. ethanol + $70^{\circ}C$,
- c. ethanol - $30^{\circ}C$,
- d. hexane - $30^{\circ}C$.

The extracts were centrifuged at 100000 g in the Omega 70000 at $0^{\circ}C$ and afterwards measured in the spectrophotometer in visible and U.V. area.

Extraction with NaCl and ethanol + $70^{\circ}C$ did not give any information. At ethanol - $30^{\circ}C$ and hexane - $30^{\circ}C$ peaks were found between 260 - 290 nm.

However this spectrum was too broad for further analysis.

Further research with other extraction methods e.g. sephadex column is desirable.

- ad 2. Effects of irradiation on enzyme-activities in prepacked cut chicory. (Y.Tanaka)

It is accepted that the activity of some enzymes, especially peroxidase, polyphenolase (tyrosinase) increase in injured

tissue and that they contribute to the browning due to the lypin formation.

Starting from this premise, it was supposed that similar enzymes may also affect the shelflife of prepacked cut vegetables after irradiation.

As a model prepacked cut chicory was chosen and the activities of peroxidase and polyphenolase during storage were controlled. Therefore, extraction is done with a cooled citrate-phosphate buffer (pH 6,5) and enzymes are measured spectrophotometrically by a modified A.C.Machie and B.Chance method.

Results show that the peroxidase activity increases immediately after cutting but that this increase is reduced by irradiation (doses 0, 100, 300 krad γ -rays). A temporary increase is also observed for the polyphenolase activity and this increase is delayed for approx. 2 days by irradiation (same doses).

The brown colour appears immediately after irradiation on the edge of the cut samples but no change in the polyphenol content (acetone soluble) as a result of irradiation is observed.

These preliminary results suggest that irradiation affects some enzyme activities but these activities could not directly be related to the observed browning.

Publications - 1973.

1. LANGERAK D.Is. and M.F.L. BRUURS.

Preliminary study concerning the influence of combined heat and radiation treatment on the quality of some horticultural products.

Acta Alimentaria, 2 (2), 229 - 243 (1973)

External reports - 1973

No. 8 -D.Is.LANGERAK, R.HOVESTAD, E.VAN DUIJVENDIJK.

Influence of irradiation and packaging in the keeping quality of prepacked endive.

Season 1972

No.10 -D.Is.LANGERAK and R.HOVESTAD.

Irradiation of prepacked cut onions.

Season 1972

No.13 -D.Is.LANGERAK and R.HOVESTAD.

Influence of handling packaging and irradiation on the keeping quality of prepacked cut chicory.

Season 1973

In Press

1. D.Is.LANGERAK.

The influence of irradiation and packaging in the keeping quality of prepacked vegetables.

Acta Alimentaria

Resultaten van het project No. 27

Hoofd van het team en wetenschappelijke medewerkers:

Alan S. Robinson.

Titel van het project: Genetical control of *Hylemya antiqua*
Meigen by structural chromosome mutations.

Beschrijving van de resultaten:

The isolation of radiation induced viable chromosome mutations necessitates the establishment of a dose response curve for dominant lethality.

a. Dose Response Curve for Dominant Lethality.

As mature sperm provides a homogeneous cell sample and is sensitive to the induction of translocations, 7 day old adult male *Hylemya antiqua* Meigen were used as test insects. They were treated with various doses of X-rays and mated in mass to virgin females for 3 days. The males were then discarded and the females were placed in individual cages where two biological end-points were assessed in the eggs produced by the mated females; % egg hatch and the % of "brown" eggs. Brown eggs are eggs which do not hatch but in which there has been recognisable development i.e. this provides a measure of late embryonic lethality. The results are shown in Fig. 1. The male *H. antiqua* is remarkably radiosensitive for Diptera, a dose of 3 krad induces almost 100% dominant lethality. Contrast this with the sterilizing dose for other Diptera, *Glossina morsitans* Westwood 12 krad; *Culex pipiens* L., 8 krad and *Drosophila melanogaster* Meigen, 9 krad.

The top part of Fig. 1 shows the percentage of brown eggs as a function of dose. There were significant differences between these percentages (F: 5.7*** d.f. 9 and 40). There was a peak in the observed percentage of brown eggs at 1000 rad. The subsequent lowering of the point at higher doses is postulated to occur as the result of increased radiation damage leading to progressively earlier egg death.

In general; the higher the radiation dose administered to the parental generation the more translocations will be recovered in the F₁ offspring. However, if translocations are to be used as homozygotes in an insect control programme it is desirable to use as low a dose as is practically feasible in order to minimise other genetic damage. A dose was chosen which gave 50% dominant lethality i.e. 500 rad.

b. The isolation of chromosome aberrations in the F₁ generation using egg hatch data and confirmatory cytological evidence.

Individual pair matings between F₁'s, of both sexes and control insects were made and the % egg hatch and the % of brown eggs was assessed in each case. It has been previously found that translocation heterozygotes produce these sterility effects by acting as late embryonic lethals i.e. they generate brown eggs. Therefore by a combination of these two assessments, tentative aberration stocks were isolated. The presence or absence of aberrations could be verified cytologically. This part of the work was done in collaboration with C. van Heemert, Dept. Genetics, Wageningen.

To the time of writing 3 new aberrations have been isolated, two translocations and a pericentric inversion. The fertility of these aberrations in test crosses to control insects can be seen in Table 1. Both the translocations exhibited a fertility of approximately 50% calculated from the small amount of data so far available. The reduced fertility of the inversion provides evidence of genetic crossing over within the inverted segment in the female of *Hyalemya antiqua* Meigen. It is postulated that if crossing over is absent in the male (as in most Diptera) then the fertility of the inversion heterozygote will not be reduced. Inbreeding programmes for the homozygosing of these aberrations have been initiated.

Table 1

The mean % egg hatch in single pair crosses to control insects of three chromosome aberrations in *Hyalemya antiqua*.

	% Egg Hatch	
	♀ tested	♂ tested
Translocation 1	*	48.9
Translocation 2	55.9	62.9
Inversion 1	58.5	*

* data not yet available.

Publications - 1973

ROBINSON, A.S. and PROVERBS, M.D. Hybridization between geographical races of the codling moth.
Can.Ent. 105: 284-290 (1973).

ROBINSON, A.S. Increase in fertility, with repeated mating, of gamma irradiated male codling moths, *Laspeyresia pomonella* (L.).
Can.J. Zool. 51: 427-430 (1973).

ROBINSON, A.S. and CURTIS, C.F. Controlled crosses and cage experiments with a translocation in *Drosophila*.
Genetica (in press).

ROBINSON, A.S. Gamma radiation and insemination in the codling moth, *Laspeyresia pomonella*.
Ent.Exp. and Appl. (in press).

FRISSEL, M.J. and WIJNANDS-STAB, K.J.A. Computer simulation of genetic manipulation as a means of controlling onion fly populations.
In "Transactions 7th IACA Congress on Hybrid Computation" Prague 1973.

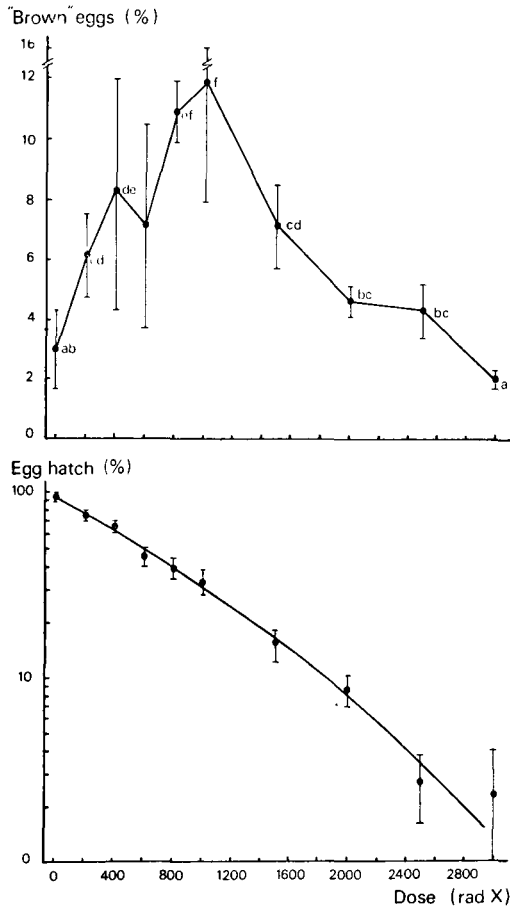

Fig. 1*. Dose response curves of % egg hatch (bottom graph) and % brown eggs, late embryonic lethals (top graph) in X-irradiated *Hylemya antiqua* Meigen males mated to control females.

* Means followed by the same letter are not significantly different from each other at the 5% level as determined by Duncan's multiple range test.

Resultaten van het project No. 28

Hoofd van het team en wetenschappelijke medewerkers:

D. Snieder

Titel van het project: Genetical control of *Adoxophyes orana* F.R.

Beschrijving van de resultaten:

Various aspects of radiobiological research for a genetical control of *A. orana* have been investigated:

- a. For the comparison of the effect of fast neutrons and X-rays adult moths (up to 24 h old) have been irradiated with a dosage of 3 krad fast neutrons. The resulting progeny was outcrossed with untreated moths in single-pair matings during succeeding generations. In fig. 1 the course of the fertility in those succeeding generations is depicted. As with the course of fertility after irradiation with X-rays (see Annual report 1972), we can conclude that the F_1 from irradiated females has an average percentage egg hatch that equals or exceeds that of the parent generation, while the F_1 from irradiated males has an average percentage egg hatch which is obviously lower than that of the P-generation. It can also be concluded that within a very few generations (2-3) most of the induced sterility disappeared. In other words, in these respects no qualitative but only quantitative differences between X-rays and fast neutrons are found.
- b. Experiments have been carried out to get evidence concerning the hypothesis that the difference found between the heridity of chromosomal aberrations in irradiated male and female moths can be explained by the moment of meiosis in relation to the moment of irradiation. Female moths were therefore irradiated with 2 krad, 4 resp. 16 h after emergence; their F_1 progeny was outcrossed with untreated moths in single-pair matings. However, no differences in percentages of egg hatching could be detected between both groups of B1-progeny. Later on, Suomalainen (personal communication) stated that this was acceptable, because of the fact that at any time after emergence, the eggs in the ovaries are only in meiotic metaphase I or in phases preceding it. In other words, this experiment could not give the proper answer because the amount of meiosis to the moment of irradiation was exact the same in both cases. Concerning the same problem, a study is now underway after irradiation of third and fifth instar larvae with 2 and 5 krad ^{60}Co γ -rays. Third instar larvae all have premeiotic egg and sperm stages as well as fifth instar female larvae,

while fifth instar male larvae have partly premeiotic, partly post-meiotic stages.

- c. For a theoretical evaluation of the effects of the release of moths with certain degrees of sterility a computerprogramme has been worked out. In the original model only percentage sterility, mortality between first instar and adulthood and shifts in the ratio males to females were variable. To trace also the influence of other factors, data on competitiveness, developmental time and multiple mating are being sampled. It was established that untreated females mated first with untreated males, mate for 23% a second time, while untreated females, mated first with irradiated (25 krad X-rays) males, mate for 55% another time. Fig. 2 can be explained in such a way that their irradiated sperm is less competitive than untreated sperm: untreated sperm from the first or second mating induces almost the same distribution of egg hatch classes. Irradiated sperm, however, does not lower after the second mating the fertility to the same degree as do the irradiated sperm of the first mating. Because of the big variation in % of egg hatching, fertilized by untreated sperm, we are not sure concerning this explanation.
- d. Finally practical assistance was given to the release programme of dr. G.W. Ankersmit (Dept. of Entomology, Wageningen). It was established that not sterile but semisterile moths were released. By sampling male larvae from the experimental orchard and searching their testes for visible chromosomal rearrangements, we were able to establish the occurrence of larvae probably originating from a mating between a wild female and an irradiated male. In July 4% of the checked larvae possessed chromosomal aberrations, in September 24%.

Publications 1973

SNIEDER, D., G.W. ANKERSMIT and H.J. TER VELDE. Studies on the sterile male technique as a means of control of *Adoxophyes orana* F.R. (Lepidoptera, Tortricidae)

2. Dose response curves after irradiation of the moth with X-rays or fast Neutrons. Neth.J.Pl.Path., 79, 148-155 (1973).

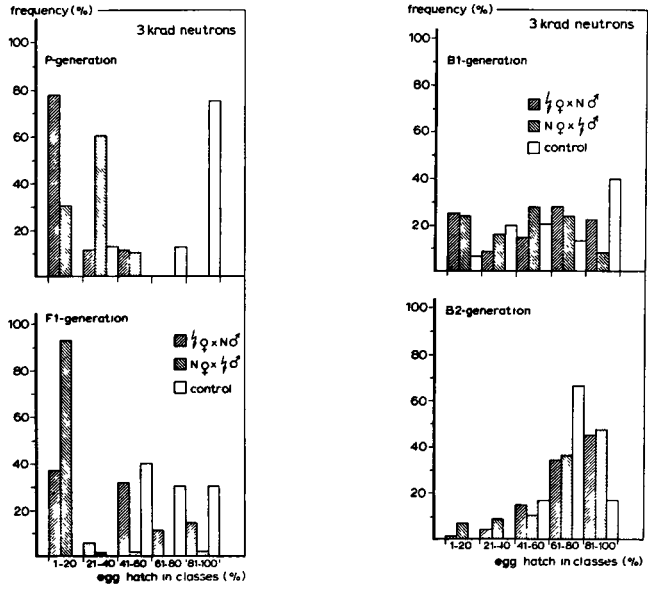

fig. 1. The course of sterility in succeeding generations after irradiation with 3 krad fast neutrons.

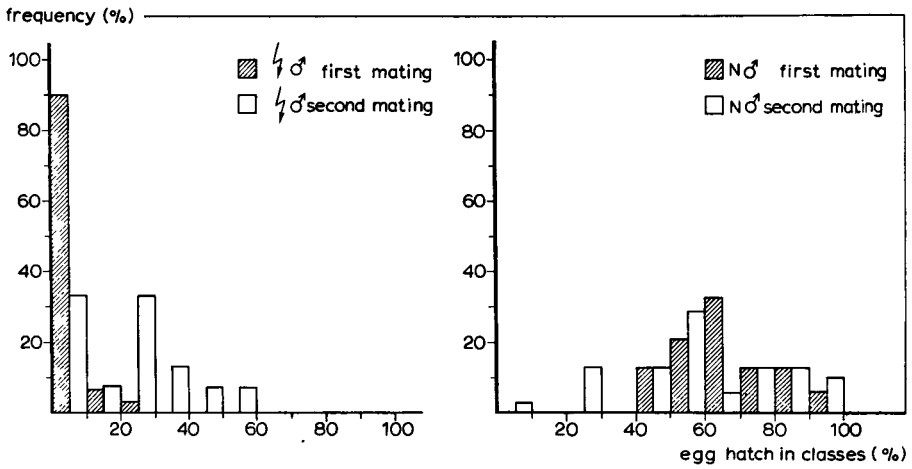

fig. 2. Frequency distribution of % egg hatching for the following four categories:

1. Eggs laid by untreated females after a first mating with irradiated males (fig. 2A).
2. Eggs laid by the same females after a subsequent mating with irradiated males (fig. 2B).
3. Eggs laid by other untreated females after a first mating with untreated males (fig. 2B).
4. Eggs laid by these females after a subsequent mating with irradiated males.

Hoofd van het team en wetenschappelijke medewerkers:

A.M. Feldmann.

Titel van het project: Genetical and Radiobiological studies on the two-spotted spidermite *Tetranychus urticae* (Koch).

Beschrijving van de resultaten:

Main subject of the experiments in 1973:

Before translocationhomozygous stocks, for genetic control purpose can be efficiently isolated, it is of ultimate importance, that enough basic radiogenetical data of the species studied are available. To achieve this aim, the main subjects of the experiments executed in 1973 are the refining and the improvement of the initial experiments in order to establish the dose-response relationship for dominant lethals, recessive lethals and structural chromosome mutations, induced by irradiation of either males or females of *Tetranychus urticae* (Koch) with X-rays or fast neutrons.

1. Dominant lethals.

T. urticae is an arrhenotokous reproducing arthropod i.e. unfertilized females produce only haploid eggs, that develop into haploid males, fertilized females produce two types of eggs: unfertilized ones, that develop into males and fertilized ones, that develop into diploid females. From this way of reproduction it follows that a simple determination of the hatch of a heterogeneous sample, consisting of haploid- and diploid F₁-eggs is not a reflection of the expression of dominant lethality as is the case in most insects, which produce only diploid eggs. In the F₁-diploids (eggs and developmental stages up to adulthood) only dominant lethals will express themselves by mortality, but in the haploid F₁-eggs and F₁-haploid developmental stages, dominant lethals as well as recessive lethals can express themselves. As diploid- and haploid eggs and early developmental stages cannot be distinguished morphologically from each other, a method is developed by which the number of diploids in a heterogeneous sample of haploids and diploids can be determined. The estimated mortality frequency of F₁-diploids is then corresponding with the frequency of dominant lethals (assuming at least one dominant lethal per dead F₁-diploid). For calculation of the dominant lethal frequency, two formulas are used, depending on whether males or females are irradiated. When males are irradiated and following to irradiation are mated to virgin females, the radiation effects are only found in those eggs with a parental male genome complement (diplod progeny).

Irradiation of virgin females, mated afterwards, produces effects in both types of eggs.

The formulas are:

$$\text{For male irradiation: } D = 1 - \frac{ft(e_{mc} - \frac{m_{mc} \times e_{uc}}{m_{uc}})}{fc(e_{mt} - \frac{m_{mt} \times e_{uc}}{m_{uc}})}$$

$$\text{For female irradiation: } D = 1 - \frac{ft(e_{mc} - \frac{m_{mc} \times e_{uc}}{m_{uc}})}{fc(e_{mt} - \frac{m_{mt} \times e_{ut}}{m_{ut}})}$$

symbol description:

ft = number of females in the test (= irradiation experiment)

e_{mc} = number of F_1 -eggs produced in the control in which parental females are mated with untreated males.

m_{mc} = number of F_1 -males, produced by the mated females of the control.

e_{uc} = number of F_1 - eggs, produced by unmated control females.

m_{uc} = number of adult F_1 - males produced by the unmated control females.

fc = number of adult F_1 -females counted in the control of the mated females.

e_{mt} = number of F_1 -eggs produced by the females of the irradiation experiments.

m_{mt} = number of adult F_1 -males produced by the females of the irradiation experiment.

e_{ut} = number of F_1 -eggs produced by irradiated virgin females.

m_{ut} = number of F_1 -males produced by the irradiated virgin females.

The results obtained by the described method are in agreement with the literature on induction of dominant lethals in insects, in contrary with the results obtained before by using the formula of Atwood et al (1956). The most probable reason is that Atwood et al did not incorporate in their calculations the mortality of diploid F_1 -eggs, estimated in a control experiment.

The dose-response relationships with dominant lethality for X-rays and fast neutrons (dose-rate for both is 100 rad/min, γ -contamination of fast neutron irradiation is 264 r/h), applied on males or females of *T. urticae*, are presented in fig. 1-3.

The mean value and standard deviation for each dose is calculated from ten replicates, each existing of five parental females mated to five males. The egg-samples from which dominant lethality is calculated, are collected for each treatment in the same period after irradiation of the one day old adult virgin males or one day old adult virgin females i.e. 24-48 h after the irradiation treatment. In order to standardize the results, the survival of F_1 -diploids (= 1- dominant lethality frequency) is on the vertical axis and the dose applied is on the horizontal axis of fig. 1 and 2. From fig. 1a and 2a is concluded that the dose response relationship for dominant lethality induced in sperm is a "one radiation event" mechanism, with an R.B.E. =1, for the survival of the F_1 -zygotes, for all dosages.

From fig. 1b and 2b is concluded that the dose response relationship for dominant lethality induced in eggs, is a "two radiation events" mechanism with an R.B.E., for survival of the F_1 -zygotes, is 2.5 for all dosages.

2. Recessive lethals.

In fig. 3 is presented the survival of F_1 haploids progenerated by irradiated 1 day old adult virgin females, not mated afterwards. The graph of fig. 3a is essentially not different from the graph of fig. 1b and the same accounts for fig. 3b and fig. 2b. Also the R.B.E. for all dosages for the survival of F_1 -haploids, produced by X-ray irradiated or fast neutron irradiated parental virgin females is 2.5.

It is demonstrated by these experiments, that in the eggs of *T. urticae* no significant induction of recessive lethals by irradiation of parental virgin females by either X-rays or neutrons is found. In the case of induction of recessive lethals the survival of F_1 -haploids would be significant lower, at the different dosages, than the survival of F_1 -diploids at corresponding dosages.

3. Induction of structural chromosome mutations or translocations.

In the 1972 annual report, "fertility-patterns" of F_1 -females, descending from irradiated male parents, were presented. The classification of those F_1 -females was found to be too subjective and a more satisfying method was developed in 1973.

In the first method, the mortality of the progeny of the unfertilized F_1 -female was compared with the mortality of the haplo-diploid

progeny of the same female, produced after mating. It is evident that the magnitude of the eventual shift of the mortality depends on the ratio of diploid eggs to the total number of the mixture of haploid- and diploid eggs (a mortality-shift is expected when the F_1 -female is heterozygous for a recessive lethal. When the F_1 -female is heterozygous for a translocation, the mortality of the haploids is the same as for the diploids, because of the production of unbalanced gametes).

In the new method, also the sexratio in the progeny of the fertilized F_1 -female is established, in order to calculate the mortality of the diploid eggs. So, the mortality of the haploid eggs is compared with the mortality of the diploid eggs, produced by the same F_1 -female.

Up till now this new method is applied on male irradiation and female irradiation experiments with X-rays as well with neutrons. These results will be presented in the next annual report.

Publications - 1973

BEELEN, R.H.J., A.M. FELDMANN and H.J.W. WIJSMAN. A regulatory gene and a structural gene for alaminase in *Escherichia coli*. Molec.gen. Genet. 121, 369-374 (1973).

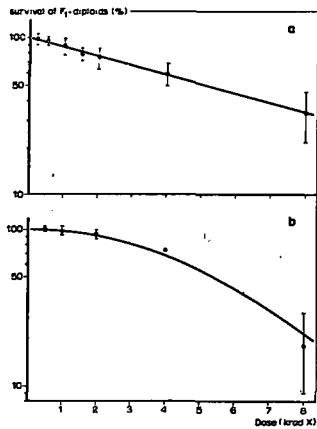

fig. 1. Dose-survival curves for F₁-diploids of *Tetrahymena urtiliana* produced after irradiation with X-rays of:
 a) 1 day old adult parental virgin males
 b) 1 day old adult parental virgin females

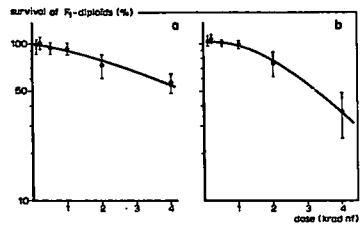

fig. 2. Dose survival curves for F₁-diploids of *Tetrahymena urtiliana* produced after irradiation with fast neutrons of:
 a) 1 day old adult parental virgin males
 b) 1 day old adult parental virgin females.

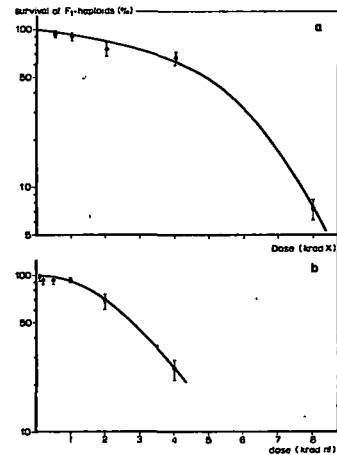

fig. 3. Dose-survival curves for F₁-haploids of *Tetrahymena urtiliana* produced after irradiation of:
 a) 1 day old adult parental virgin females with X-rays
 b) 1 day old adult parental virgin females with fast neutrons.

Resultaten van het project No. 30

Hoofd van het team en wetenschappelijke medewerkers:

G. Sauer, S.C. van de Geijn, G.P. Mix.

Titel van het project: Measurement and localization of biological processes at tissue cellular and subcellular level.

Beschrijving van de resultaten:

The results obtained in this project during 1973 mainly arrive from a combined application of the available methods to a specific topic: the uptake of ^{45}Ca after rootapplication to bean plants (*Phaseolus vulgaris* L. cv. Saxa) in the fruiting stage. Some interesting physiological aspects of the accumulation of calcium have been studied.

In long term experiments it was found that after 3-5 days of treatment with ^{45}Ca -labelled solution in some parts of the plant an important redistribution takes place in a subsequent period of 7 days, whereas in other parts the labelling level remains perfectly stable. More precisely, it was found that the countrate measured by semi-conductor detectors placed at the dorsal side of older fruits after 7 days stabilized at about 30-40% of the maximum countrate which is reached at the end of the labelling period, whereas the countrate at the ventral side of the fruit remained constant.

For younger fruits the dorsal as well as the ventral side showed a constant countrate. The ^{45}Ca countrate measured at the stem reduced to 15% of its maximum level, and the leaf again showed no change whatsoever.

Analyses of the spectra, obtained during different stages of the experiment showed a remarkably stable internal distribution of the radioisotope, at both sides of the fruit. A thin layer of heavily labelled material was present at 0 to 100 μm below the surface, at the position of the vascular bundle.

This was confirmed by a microautoradiographic study. The thin layer of heavily labelled cells was identified as the bundle sheath. Some of the cells were filled almost completely by a small crystal, as confirmed by the observation in a polarization microscope.

The chemical nature of the crystals was determined by a treatment with weak respectively strong acids, and found to be calciumoxalate. A first test was done subsequently to determine the distribution of the stable calcium in the considered tissue part. Samples were prepared for observation in the scanning electron microscope, equipped with an X-ray fluorescence measuring system.

The embedding agent used for the light microscopic observation (methacrylate) turned out to be not fitted for this type of observations. The embedding material and consequently the tissue were seriously damaged by the bombardment with the electron beam. Nevertheless it was possible to draw a first conclusion from the obtained pictures.

The majority of calcium in the tissue was concentrated in the cells of the bundle sheath filled with the small crystals. The region between this accumulation tissue and the cuticula contained less calcium compared to the tissue inside this layer.

Whether, and to what extent the mentioned cell layer functions as for the calcium redistribution, still has to be investigated. The dependence on growthstage of the fruit is also an unknown factor. Preliminary experiments have been done to investigate the lateral movement of cadmium in the stem of tomato plants (coll. Ch. Petit, proj. 6). The redistribution from the transport vessels to other tissue parts, more near to the surface is studied by measuring the beta-spectrum of ^{115m}Cd and determining the maximum energy thereof. Analyses of the results is in progress.

Publications - 1973.

Some considerations concerning microlocalization in dehydrated and living plant material.

DIRKSE, W.G. and G. SAUER.

I. Track autoradiography of soluble substances.

VAN DE GEIJN, S.C.

II. Beta spectrometric localization in living plants.

Trans. of the IIIrd Symp. on Accum. and Transloc. of Nutr. and Regulators in Plant Organisms. Warszawa, Jablonna, Skierniewice, Brzezna, Krakow, 14-18th May 1973 pp 571-589.

VAN DE GEIJN, S.C. On the determination of electron energy losses in absorbers. A study of the ^{137}Cs spectrum.

Nucl. Instr. and Meth. in press.

VAN DE GEIJN, S.C. In depth localization of beta-emitting isotopes; Dependence of the range of applicability upon maximum energy and complexity of the spectrum. Nucl. Instr. and Meth. in press.

B Resultaten van het project No. 31

Hoofd van het team en wetenschappelijke medewerkers:

A.F. Groneman.

Titel van het project: Recycling of liquid waste.

Beschrijving van de resultaten:

Research into the effects of atomic radiation on sludge has started in November 1973.

A review of published research is in progress. Instruments and analytical methods are in the stage of development in order to measure the influence of irradiation on physical and chemical characteristics of sludge.

Resultaten van het project No. 32

Hoofd van het team en wetenschappelijke medewerkers:

J.F. Stoutjesdijk, W.F. Pieters.

Titel van het project: The propagation of nuclear methods in biology and agriculture.

Beschrijving van de resultaten.

1. Courses

.1 General radioisotope course

A general radioisotope course has been organized from March 12 - 30, 1973 with 22 participants, of whom five members of the personnel of the Association, two students of the Agricultural University at Wageningen and one guest scientist of a Wageningen Institute from Jordan.

.2 Health Physics course

In cooperation with the Health Physics Department of the Association a Health Physics course was organized, mainly for scientists of Institutes at Wageningen, who are responsible for radiochemical laboratories. The course was organized from April 9 to 13 during the mornings; 14 people participated, of whom two members of the Association.

.3 Liquid scintillation courses

Two liquid scintillation courses have been organized from November 26 till December 7, and December 10 till 21, with 19 and 20 participants respectively. Among them were one Algerian, one Czechoslovakian and three Belgian participants and two members of the Association's personnel.

2. Evaluation of Radiological techniques

.1 Effect of quenching on the influence of wavelength-shifters in Cerenkov-counting of hard β -emitters.

The counting efficiency of ^{32}P in water could be increased from 45 to 65% by addition of the wavelength-shifter 4-methylumbelliferone (100 mg/l), but by the presence of this compound the method becomes sensitive to chemical quenching. E.G. 20 g/l trichloroacetic acid gives a decrease in counting efficiency of 26%. Also HClO_4 , H_2SO_4 and especially HNO_3 cause quenching. The channels ratio method proved to be suitable for quench corrections. The counting efficiency of ^{32}P in 40% H_2SO_4 -solutions was 4% higher than in water, but in 90% H_2SO_4 6% lower than in water.

.2 Determination of small amounts of fission products from tests with nuclear weapons and activated corrosion products from nuclear reactors in fish and fishery products.

For the Ministry of Agriculture and Fisheries, fish and fishery products will be investigated for the presence of radioactive contaminants. Preliminary experiments were performed (W.F. Pieters) to study the preparation of samples for counting with a new semi-conductor detector assembly. Suitable samples could be prepared by pressing with a hydrolic press 10 g of ash (from about 1 kg fish) to which 10 g of carbon black had been added, to cylinders with a diameter of 5 cm and a height of 1 cm (density 1 g/cm³). The samples were measured with a Ge(Li)-semi-conductor detector and a 4000 channel γ -spectrometer. According to preliminary experiments 10 - 50 pCi/kg of ⁵¹Cr, ⁵⁴Mn, ⁵⁹Fe, ⁵⁷Co, ⁶⁰Co, ⁶⁵Zn and ¹³⁷Cs could be detected. With a better leadcastle it is expected that the sensitivity of the method will be improved with a factor of at least two, whereas processing of a larger amount of ash may give a further increase in sensitivity.

The counting data will be processed by the PDP-11 computer which was delivered in November 1973.

.3 Determination of metals in fish and fishery products.

For the Ministry of Agriculture and Fisheries, fish and fishery products were investigated for the presence of several metallic elements. Cr, Mn, Fe, Co, Cu, Zn and Hg were determined by the Soil Group with atomic absorption spectroscopy (AAS). Some analyses of Cr, Fe, Co, Zn and Hg were also performed by neutron activation analysis (NAA) by the Soil Group: good agreement between the two methods was found with Fe, Zn and Hg; for Cr NAA gave appreciably lower values than AAS; for Co NAA mostly gave somewhat higher values.

The results of the analyses in 1973 are collected in table 1.

Preparations have been made for neutron activation analysis of the samples with a 72 cm³ Ge(Li) semi-conductor detector and processing of the data with an on-line PDP-11 computer of Digital Equipment. This computer has been installed in November 1973.

3. Cooperation with other Institutes.

Determination of algal growth in surface water:

cooperation with Mr. W. Eenkhoorn of the Governmental Service for the IJsselmeerpolders.

A method was developed to prepare samples for liquid scintillation counting with sufficient reproducibility and stability.

4. Work for C.C.R.A.

For the Coordination Commission Radioactivity Measurements (C.C.R.A.)

the annual report 1972 was prepared. As technical secretary of C.C.R.A.

Stoutjesdijk was a member of a commission of the Health Council to

prepare safety standard for the biosphere after nuclear accidents. This

commission has met two times in 1973.

5. Newsletter on the Application of nuclear methods in Biology and Agriculture.

In order to give more publicity to radiological methods suitable for

agricultural and biological research a proposal has been made for

issuing a Newsletter under the auspices of ESNA.

A first experimental Newsletter was distributed in August and about 80

European scientists have responded favourably.

Table 1 Contents of metals in fish and fishery-products determined by atomic absorption spectrometry.

Product	Sampling location	Sampling date 1973	Content in mg/kg fresh material									
			Cr	Mn	Fe	Co	Cu	Zn	As	Cd	Hg	
Sole	Northsea near Texel	January	0,52	0,29	5,7	x)	-	-	5,8	2,7	<0,01	0,09
		April	0,32	0,11	8,9	-	0,42	5	0,09			
		July	0,46	0,34	59	-	0,25	6	0,11			
	Northsea near Scheveningen	January	0,59	0,24	6,7	-	-	9,7	2,5	<0,01	0,08	
		April	0,33	0,13	6,9	-	0,35	5,4	0,16			
		July	0,11	1,4	8,6	-	0,34	7	0,22			
		April	0,26	0,13	6,9	-	0,35	5	0,23			
Pike-perch	Ij'ssellake	July	0,08	1,7	3,4	-	0,22	7	0,06			
		January	0,77	0,21	14	-	-	4,6	0,02	<0,01	1,06	
		July	-	0,08	3,4	-	0,09	6	0,83			
Shrimps	Dollard	January	0,90	2,0	39	0,04	9,1	21	<0,01	0,16		
		April	0,57	3,0	63	-	15,5	35	0,20			
		July	0,32	2,7	25	-	8,8	21	0,06			
		January	1,1	1,6	42	0,03	6,2	23	<0,01	0,08		
Mussels	Northsea near Texel	April	0,41	1,6	62	-	2,9	33	0,13			
		July	0,50	2,3	50	-	14,4	19	0,15			
		January	1,1	1,7	74	0,05	8,9	22	<0,01	0,08		
	Northsea near Breskens	April	0,98	2,4	88	-	12,8	34	0,14			
		July	0,39	2,3	32	-	9,6	25	0,06			
		January	0,78	5,4	74	0,14	1,6	29	<0,01	0,13		
		April	0,64	3,1	71	0,26	1,2	31	0,09			
Oosterschelde	July	1,11	12,0	240	0,32	1,2	32	0,07				
	January	0,67	6,0	125	0,14	1,3	20	<0,01	0,14			
	April	0,44	5,2	134	0,22	1,5	27	0,07				
	July	0,70	5,9	127	0,24	1,3	18	0,04				
Oyster	Oosterschelde	July	0,23	5,6	85	-	20,3	830	0,06			

x) - = not detectable

Resultaten van het project No. 33

Hoofd van het team en wetenschappelijke medewerkers:

J.G.de Swart, J.F.Stoutjesdijk

Titel van het project: Development of nuclear techniques and related instrumentation for biological and agricultural research.

Beschrijving van de resultaten.

The items 1,2,3,4,and 5 of this report are dealing with work directly related to the Association's programme. The items 6-13 are related to work carried out in cooperation with institutes outside the Association.

1. Soilcolumn scanner for water movement studies

(Cooperation with ir.L.Stroosnijder, Agricultural University of Wageningen).

A publication about this subject has been accepted by Soil Science.

2. Modifications of the Perkins-Elmer atomic absorption spectrophotometer.

A fast peak detector with punch tape read out has been realized. The development of a sample changer for 50 samples has been postponed due to other priorities.

3. Protection system for maintenance workers during nights and week-ends at the Institute.

An automatic alarm system was developed. The system operates via a radiotranceiver combined with a semaphore terminal in such a way, that the operator will be called automatically at fixed time intervals. If he does not react on these calls, the on-duty Health Physics functionary will get an alarm via his semaphore. The system became operational beginning 1973 and has proved to be very reliable during the rest of 1973.

4. Pneumatic samplechanger.

The development of a samplechanger was started for the Ge(Li) semiconductor detector for the determination of low activity fall out products and activated corrosion products in fishery products and for the measurement of activated samples for the determinations of heavy metals in fishery products by means of neutron activation analysis. The detector will be shielded in this system with about 400 kg old lead (at least 170 years old).

5. Data collection system

The development of this system was started to facilitate the solution of actual measurement problems. It collects both digital and analog data and registration is done by punch tape, magnetic tape or parallel printer. Due to the introduction of the Racal cassette tape-recorder in Wageningen as a standard, the adaptation to our data-collection systems involved extra development work resulting in a delay in realization of our read-out facilities.

6. Velocity measurements of granular material in an elevator system.

(Cooperation with ir.D.J.van Zuilichem, Department of Food Science, Agricultural University, Wageningen).

Experiments were extended by measurements of the density of the flowing material, especially in the acceleration traject, with the help of a γ -absorption technique. An article about the subject has been presented at the second international conference on the pneumatic transport of solids in pipes. Extension to horizontal transport measurements will be desirable in the future programme.

7. Measurements of density variations of flowing granular material in silo systems.

(Cooperation with ir.D.J. van Zuilichem, Department of Food Science, Agricultural University of Wageningen).

Experiments are continued according to planning.

For determination of direction and velocity of the grains, measurements have been performed with a pulsed X-ray apparatus. After marking some grains with contrast material, direction of the material and, if the pulse-intervals are precisely known, the velocity can be derived from the exposed photographic film.

8. Measurements of residence-time distributions of liquid in a Centritherm evaporator.

(Cooperation with ir.H.Akse, Department of Food Science, Agricultural University of Wageningen).

The Centritherm is used for evaporating fruit-juices and the quality of the product depends partly on a uniform residence-time. For measurement of the residence-time distributions, a radio-tracer technique has been applied as already described for measurements on maize in an extruder (see Annual report 1972). As the injection time of the tracer in the inlet-stream is not neglectibly short, the inlet and the outlet tubing are both led

along the detector. In this way the measured curve (response) can be corrected for the non-ideal shape of the input impulse.

9. Moisture content measurements in plant leaves.

A two-channel system was built for ir.H.Challa, Centre for Plant Physiology Research, Wageningen.

10. A single channel γ -spectrometer with teletype read out.

has been built for the Department of Food Science, Agricultural University of Wageningen.

11. Measurement of the water-oil ratio in soils.

(Cooperation with Mr.P.G.C.de Jong, Kon./Shell Exploration Production Laboratory, Rijswijk).

Experiments have been performed to test the suitability of γ -absorption measurements for determination of the water-oil ratios in mixtures of these two components. The method proved to fulfill the requirements and it is being used in simulation models to study the driving out of oil by water in porous layers of soil in oil-fields.

12. Cooperation.

with the Technical and Physical Engineering Research Service (T.F.D.L.), Wageningen, in behalf of the Department of Animal Science of the Agricultural University, Wageningen, to study the possibilities of automatic registration of electrical signals from muscles and movements of animals for correlation investigations.

13. Cooperation with H.de Regt, Department of Physics and Meteorology, Agricultural University of Wageningen, to study the possibilities of using positron-emitters for localization problems.

14. Cooperation.

with the Department of Virology, Agricultural University of Wageningen (Mr.Tas): determination of ^{125}J with a single channel γ -spectrometer and by liquid scintillations counting.

15. Advices

have been given to Mr.Visser, Department of Biochemistry of the Agricultural University, Wageningen, about the procuring of a nanosecond fluorescent decay measurement system, to several institutes about the purchase of liquid scintillation apparatus and to ir.J.Birnie of the Department of Physics of the Agricultural University, Wageningen about the advisability of revision and modification of an existing data acquisition system. After an extensive examination a negative advice was given.

With Prof. Schaafsma, Department of Molecular Physics of the Agricultural University of Wageningen, the labeling of virus material and algae with ^2H and ^{13}C for NMR-studies have been discussed.

With Drs. H. van Lonkhuisen, Institute for Cereals, Flour and Bread, TNO, Wageningen, the use of ^{14}C -monoglycerides for studying starch suspensions has been considered.

With scientists of the Deltadienst, Department for Milieu Research, The Hague, the possibilities of the use of radionuclides have been discussed for the study of the pathway of phosphates in the river Rhine.

Publications 1973.

-VAN ZUILICHEM, D.J., DE SWART, J.G., BUISMAN, G.

Residence time-distribution in an extruder, Lebensm. Wiss. Technol., 6 (1973) 184.

-STROOSNIJDER, L. and DE SWART, J.G.,

Column scanning with simultaneous use of ^{241}Am and ^{137}Cs gamma radiation.

Soil Science, in press.

-VAN ZUILICHEM, D.J., BLEUMINK, G.H., DE SWART, J.G.

Slip velocity measurements by radio-tracer techniques in vertical conveying systems of different pipe diameters.

Proceedings of the second international conference on the pneumatic transport of solids in pipes. 'Pneumotransport 2', Guilford, Surrey England (1973).

-POELSTRA, P., BANNINK, D.W., and DE SWART, J.G.

An experimental approach to study the migration of pollutants in undisturbed soil columns.

Agricultura 21 (1973) 147.

-STROOSNIJDER, L. and DE SWART, J.G.

Letter to the editor 'Errors in Soil Bulk density and water content Measurements with Gamma Ray Attenuation'.

Soil Science Society of America Proceedings.

37 (1973), 485.

- Contractant de la Commission : Université Louis Pasteur-Faculté de Médecine-Laboratoire de Biophysique des Rayonnements et de Méthodologie-11, rue Humann, 67000 Strasbourg.
 - N° du Contrat : SC 001-094-72-1 BIAN
 - Chef du groupe de recherche : R.V. RECHENMANN
 - Thème général du Contrat : Development of high-efficiency and high-resolution ionographic methods - Applications to autoradiographic problems.
-

The prospection of the new possibilities opened in the field of corpuscular photography by the introduction of the concept of the stable sub-latent image and its activation has been continued.

In the frame of these studies, activation solutions of different composition have been formulated. The possibilities offered by the "anti-activation" of the corpuscular latent image due to iridium salts are actually investigated.

The results of numerous experiments allowed to establish different formulas of "compact grain" developers. Further experiments have to be carried out in order to reduce the too high development rate of these solutions.

Our "activated" autoradiographic methods have been adapted to the study of nucleolar DNA synthesis in the liver of adult rats and to the problem of the differentiation of isolated nerve cells in culture.

Publications : KEDINGER M., MENDEL C., HAFFEN K., WITTENDORP E. et GRENIER J.F. Survival of chick embryonic organs submitted to high hydrostatic pressures. Biomedicine, 1973, 18, 311-318.

WINTZERITH M., WITTENDORP E., ITTEL M.E., RECHENMANN R.V. et MANDEL P. Mise en évidence par trace-autoradiographie activée de la synthèse de D.M.A. nucléolaire dans le foie de rat adulte. C.R. Acad. Sc. Paris, 24 septembre 1973, t. 277 Série D, 1033-1036.

JAROS G.G., SENSENBRENNER M., WITTENDORP E., RECHENMANN R.V. et MANDEL P. Prolifération des cellules nerveuses en culture. Etude trace-autoradiographique activée de l'incorporation de thymidine ^{14}C . C.R. Acad. Sc. Paris (in press).

WITTENDORP E. Thèse de Doctorat (Mention Sciences) :
Nouvelles Procédures Ionographiques - Premières Applications Microdosimétriques et Autoradiographiques.
Université Louis Pasteur de Strasbourg (24-11-1973).

RESULTATS du PROJET N°1

- Chef du projet et collaborateurs scientifiques : R.V. RECHENMANN et E. WITTENDORF
- Titre du projet : Development of high-efficiency and high-resolution ionographic methods - Applications to autoradiographic problems.

A. METHODOLOGY

I. Study of the development process

The study of the photographic processes involved in the formation and the development of the photographic corpuscular latent image has been continued, mainly along the lines already described in former reports and publications (1). Following topics have been particularly considered 1°) formulation of "compact grain" developers, 2°) study of the activation process, 3°) development temperature.

1°) Compact grain developers

It has been mentioned in former reports that we had started, in connection with our activation experiments, the development of new reducing solutions of high efficiency, producing silver grains of small diameter without a prohibitive increase of the chemical fog. A sub-group of these developers are formed by the so-called "compact-grain" reducing solutions, which should reduce the AgBr microcrystals while preserving their form and dimensions to a certain extent ; we added an even stronger requirement, i.e. these developers should be strong enough for developing microcrystals touched by low ionizing radiations, like electrons : a reducing solution of this type should also avoid the production of a too high chemical fog which may disturb the photographic recording or introduce unacceptable inaccuracies in eventual measurements. Our first attempts to formulate developers of this type had given disappointing and non reproducible results (1).

For establishing suitable developer formulas, systematical experiments have been carried out by means of the same two basic agents which have already been used in our previous attempts, i.e. amidol and ferro-oxalate.

At a first stage, we tried to find an acceptable equilibrium between the "chemical" and the "physical" development mechanisms implied in the process producing photographic silver grains, by varying the relative amounts of the constituents of very solvent developers, and also by a careful adaption of the chosen activation procedure. Unfortunately, a higher concentration of the "solvent" agents of a developer (Na_2SO_3 , KCNS, NaCNS, etc...) always results in a strong increase of the slope of the density-development time curve (Fig.1 and 2). As a consequence, the reproducibility of the results may not yet be considered as satisfactory. In order to counterbalance the fast raise of the chemical fog due to these solvent developers, anti-fogging agents have been introduced in our developing formulas.

We are actually trying to overcome the disadvantages of these new types of developers, e.g. by a careful action on some of the factors governing the speed of the photographic development like the temperature, or the negative ion layer protecting the AgBr microcrystals against charged developing agents.

2°) Further studies on the activation process

Different formulas of gold activation solutions have been established for specific uses. A nearly complete eradication of the chemical fog could be obtained in the case of particularly favorable combinations *emulsion-radiation-activation-developer*. Studies on the use of heavy metal complexes in activation solutions have been continued. It has been shown that the replacement of gold by iridium as activating agent results in a reproducible decrease of sensitivity. The possible use of this interesting characteristic of iridium for a discrimination between γ radiation and charged particles, or between different types of charged particles, will be investigated.

II. Autoradiographic resolution

The program on autoradiographic resolution has been postponed.

B. BIOLOGICAL APPLICATIONS

I. Evidence of nucleolar DNA synthesis by activated track-autoradiography in adult rat livers

In collaboration with M.WINTZERITH, M.E.ITTEL and P.MANDEL (Centre de Neurochimie du CNRS-Strasbourg), we have adapted the activated track-autoradiographic method specifically to the study of the DNA synthesis in nucleoli of adult rat liver cells, in order to confirm biochemical results already obtained (2), i.e. that nucleolar DNA of adult rat liver incorporates rapidly radioactive precursors of DNA if compared to chromosomal DNA of nuclei.

The nuclei have been isolated and prepared by suitable techniques (3) from adult rat livers labeled "in vivo" with ^{14}C -thymidine. Systematic tests have been carried out for determining the optimal staining technique, depending upon the combination tissue-emulsion-staining solution. The best results have been obtained with the Kodak NTB II emulsion, stained with Azur blue C after the development procedure, i.e. through the gelatin layer. The preparations have been submitted to the activated track-autoradiographic method (gold activation, development in ferro-oxalate at $E_{\text{redox}} \sim -320 \text{ mV}$).

Light microscopical observations of the autoradiographic preparations showed that a significant number of electron tracks are emitted from nucleoli of the isolated nuclei. The incorporation of ^{14}C -thymidine within the nucleoli is clearly visualized on Figure 3 a and b. Some heavily labeled nuclei have also been observed. These data are in good agreement with the mentioned biochemical results. A certain independence of nucleolar DNA and chromosomal DNA synthesis seems to be confirmed. An autoradiographic study on isolated nucleoli is foreseen.

II. Track-autoradiography of nerve cells in culture

Autoradiographic experiments on cultures of dissociated cells of chick

embryonic brains had been undertaken (1) in collaboration with M.SENSENBRENER, G.G.JAROS and P.MANDEL (Centre de Neurochimie du CNRS-Strasbourg). The purpose of this study is to correlate changes in the metabolism of nucleic acids with the appearance of morphological patterns of differentiation: the incorporation of ^{14}C -thymidine into neuroblastic cells should give a direct information on the multiplication of the undifferentiated cells and control their mitotic activity.

The methodology, i.e. biological preparations and autoradiography, remained unchanged in its main features during the whole of this study (1). Nerve cells from brain cortex of 7 days old chick embryos were dissociated and cultivated in Rose chambers. The labeling of the cells took place immediately at the onset of the culture or after 1, 3 or 7 days by adding ^{14}C -thymidine ($0.1 \mu\text{Ci/ml}$) to the culture medium for a duration of 24 hours. After periods varying from 1 to 21 days, the cultures were washed, fixed, impregnated with silver by the method of HOLMES before applying the activated track-autoradiographic method.

Light microscopical observations of the autoradiographic preparations showed that nearly all the nerve cells incorporate radioactive thymidine when the tracer is added to the culture medium at the onset of the culture or after 1 day (Fig.4 a and b). This result indicates a strong mitotic activity of the still undifferentiated cells, as well as their correct adaptation to the "in vitro" conditions. For protracted cultivation times (3 and 7 days) before incorporation, the behaviour of the nerve cells as described by their labeling varies depending upon their nature: the neuroblasts differentiate rapidly into neurons, while the cells from the glial lines remain still in an undifferentiated stage, at least during the first week of culture. No marked divergences could be observed if the behaviour of the nervous cells "in vitro" was compared with their evolution "in vivo".

These data justify the further use of nerve cell cultures for the study of the morphological and metabolic patterns of the differentiation. Investigations by means of activated track-autoradiography concerning factors which are supposed to influence the differentiation of primitive nerve cells are foreseen.

REFERENCES : 1) RECHENMANN, R.V. and WITTENDORP, E. J1. of Microscopy, (1972) Vol. 96, Pt. 2, 227 ; RECHENMANN, R.V. and WITTENDORP, E. Rapport Annuel 1972 EUR. 4864, 561. 2) ITTEL, M.E., WINTZERITH, M., ZAHND, J.P., MANDEL, P. Europ. J. Biochem. (1970), 17, 415. 3) CHAUVEAU, C., MOULE, Y., ROUILLER, C. Exptl. Cell. Res. (1956), 11, 317.

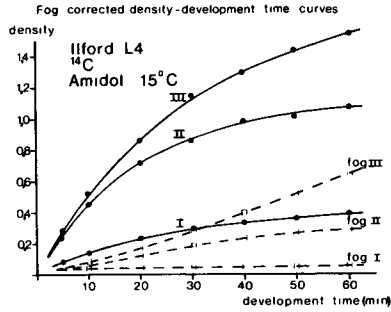

Fig 1

Fig. 1 Optical density as a function of development time in amidol developers at 15°C, after activation.

Emulsion : Ilford L4 - Source : ^{14}C .

I. "Brussels Formula".

II. "Compact grain" developer (0.5% KCNS).

III. "Compact grain" developer (1% KCNS).

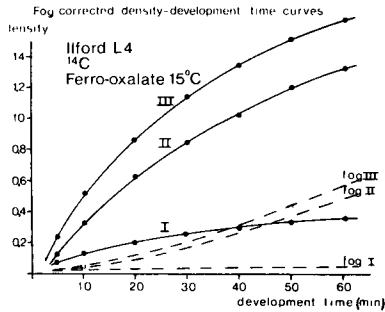

Fig 2

Fig. 2 Optical density as a function of development time in ferro-oxalate developers at 15°C, after activation.

Emulsion : Ilford L4 - Source : ^{14}C .

I. Classical ferro-oxalate developer with added
1.8% Na_2SO_3 .

II. "Compact grain" developer (0.5% KCNS).

III. "Compact grain" developer (1% KCNS).

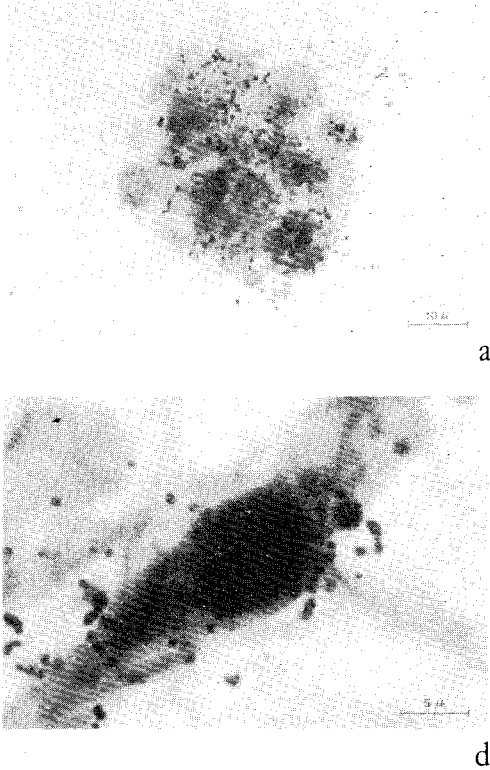
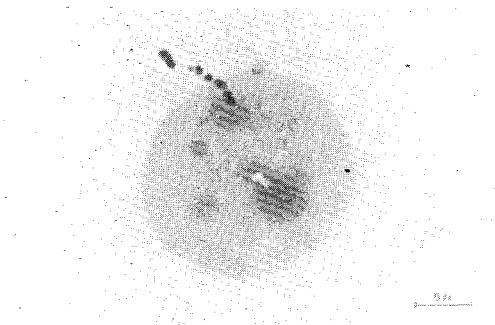

Fig. 4 Activated track-autoradiographs of dissociated nerve cells in culture (7-days old chick embryonic brains). Incorporation of ^{14}C -thymidine at the onset of the culture during 24 hours.

Emulsion : Ilford K5 - Exposure time : 17 hours
 Development : 50 min. in ferro-oxalate at $E_{\text{redox}} \approx -320 \text{ mV}$ (15°C), after gold activation.
 Silver impregnation method of Holmes.

- a) Incorporation of ^{14}C -thymidine in undifferentiated nerve cells after 48 hours of culture (x 1360).
- b) Electrons tracks originating from part of the neurons in the cultures, 2 weeks after exposure to the labeled thymidine (at the onset of the culture) (x 3000).



a

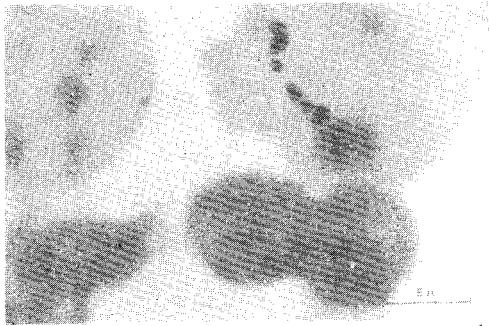

b

Fig. 3 Activated track-autoradiographs of isolated rat liver nuclei. The nucleoli are clearly visible. The ^{14}C -thymidine incorporated within the nucleoli can be easily located at the track origin of the electron emitted by the tracer element.

Emulsion : Kodak NTB II - Exposure time : 5 days

Development : Activated development for 50 min. in a ferro-oxalate solution at $E_{\text{redox}} \approx -320 \text{ mV}$ (15°C).

Coloration : Azur blue C after development, i.e. through the gelatin layer.

a) x 2700

b) x 4200

Contractant : Katholieke Universiteit Nijmegen (The Netherlands). Dr. C.J.M. Aarts, director of the Faculty of Sciences.

Contract number : SC 002-094-72-1 BIA N.

Head of the research team : Prof.Dr. H.F. Linskens.

General subject of contract : Radiation biochemistry of styles and pollen of incompatible plants.

General description of research :

Most of the research, thus far, is directed towards the unirradiated situation in order to understand the effect of irradiation. The following subjects were studied:

1. Effect of x-ray irradiation of pollen on its growth (Drs. Gilissen).
2. Influence of x-rays on the growth of pollen from *Pseudotsuga* sp (Drs. v.d. Donk - Dr. Livingston).
3. Activation of the ovary upon pollination (Prof. Dr. Linskens - Drs. Deurenberg).
4. Qualitative analysis of RNA synthesized 24 h pollination (Drs. van der donk).
5. Synthesis of RNA and proteins as a function of the time of pollentube-style interaction (Drs. van der donk).
6. Electrophysiology of the style in relation with the incompatibility reaction (Prof.Dr. Linskens).
7. Translocation and accumulation before and during anthesis (Prof.Dr. Linskens).

Results of project no. SC 002-094-72-1 BIA N.

Head of the team : Prof.Dr. H.F. Linskens.

Scientists : Drs. L.W.J.W. Gilissen.

Drs. J.A.W.M. van der ponk.

Drs. J.J.M. Deurenberg.

1. Effect of x-ray irradiation of pollen on its growth (Drs. Gilissen)

The aim of the research is to find out in what way x-rays can be used in solving problems related to the incompatibility reaction in *Petunia hybrida* L.

During irradiation, radicals are formed. There is evidence which suggests that the amount of radicals formed after x-ray irradiation, the decay of radicals and the biological damage are proportional. Radical concentrations are measured with an electron spin resonance spectrometer (ESR). The dose-effect curve of x-rays on pollentube growth in compatible and incompatible pollinations showed that the incompatibility reaction was not broken down. The only effect was a retardation of the growth rate during the first phase of pollentube growth. Experiments in which irradiated pollen was compared to pollen that was washed after irradiation revealed that washed pollen, which have lost their radicals, germinate as well as unwashed pollen irradiated with the same dose.

2. Effect of x-ray irradiation on the growth of pollen of *Pseudotsuga* sp (Drs. van der ponk - Dr. Livingston)

Although irradiation (64 kr) stimulated the growth of this pollen, no difference was found both in content and synthesis of RNA. Experiments were carried out to study protein synthetic capacity in vitro of extracted polyosomes. The first results indicated that the stimulation of amino acid incorporation into proteins was higher by polyosomes extracted from irradiated than by polyosomes from unirradiated pollen. Lack of viable pollen, however, forced us to stop these experiments.

3. Activation of the ovary upon pollination (Prof.Dr. Linskens - Drs. Deurenberg)

Activation of the ovary was studied at three levels: changes of

the fresh and dry weight, the protein, amino acids and RNA content, the changes of the polyribosome profiles and the protein synthesis in vitro with the polysomal fraction of different developmental stages after both self- and crosspollination. The activation of the ovary after crosspollination occurred before fertilization took place and started with the carpels and the placenta. Results after selfpollination showed no significant differences with those obtained after crosspollination up to 24 h after pollination.

4. Qualitative analysis of RNA synthesized 24 hours after pollination
(Drs. van der donk)

These analyses were carried out by SDS-polyacrylamide tangemgel electrophoresis. RNA labeled with ³H-orotic acids showed characteristic profiles for self- and crosspollinated styles. In crossed styles messenger-like RNA was found with a main peak of about 200,000 MW. This peak was present in all compatibly pollinated styles tested and not in selfed styles.

5. Synthesis of RNA and proteins as a function of the time of
pollentube-style interaction (Drs. van der donk)

Different patterns of synthetic activity were found upon self- and crosspollination. In selfed styles, the rate of RNA synthesis (measured as incorporation into RNA of ³H-orotic acid after a pulse of 3h) was maximal at 3 and 13h after pollination, whereas the rate of protein synthesis (measured as the amount of ¹⁴C-algal protein hydrolysate incorporated in vitro into proteins stimulated by polyribosomes extracted from styles) was maximal at 6 and 14h after pollination. In crossed styles only one maximum was found (6h for RNA, and 10h for protein synthesis). In both selfed and crossed styles the rate of synthesis of RNA and proteins was increasing from 18 to 24, and from 21-24h after pollination respectively. Analysis of the messenger activity of the newly synthesized RNA is started using egg-cells of *Xenopus levis* as an "in vitro" system.

6. Electrophysiology of the style in relation with the incompatibility
reaction (Prof. Dr. Linskens)

At this level, a rapid reaction of the style to pollination was found: at first, a positivation was observed followed by negativation of the potential. The reaction was different related to compatible and incompatible pollination. The same patterns were found in different clones. -619-

7. Translocation and accumulation before and during anthesis (Prof. Dr. Linskens)

The behaviour of labeled phosphorus, amino acids and carbohydrates suggests the existence of an internal shifting system within the flower. In mature flowers, the amino acid pool in the anthers diminishes quickly and the protein pool in the ovary increases.

Publications

- Linskens, H.F.: Activation of the ovary. Caryologia suppl. 24, 27-41 (1973)
- Linskens, H.F.: Accumulation in anthers. Proc. Res. Inst. of Pomol., Skierniewice, ser. E., 3, 91-106 (1973)
- Linskens, H.F.: The growth of the style, will appear in: Incompatibility Newsletter 4
- Linskens, H.F. & P.L. Pfahler: In vitro germination and pollentube growth of maize (*Zea mays* L.) pollen. VIII Storage temperature and pollen source effects, *Planta* 111, 253-259 (1973)
- Linskens, H.F. & E. Songheimer: Control of in vitro germination and tube extension of *Petunia hybrida* pollen, will appear in: Proc. Kon. Ned. Akad. Wet.
- Linskens, H.F. & A.W. Spanjers: Changes of the electrical potential in the transmitting tissue of *Petunia* styles after cross- and selfpollination, Incompatibility Newsletter 3, 81-85 (1973)
- Donk, J.A.W.M. van der: differential RNA synthesis 24 h after self- and crosspollination in *Petunia hybrida* L., sent for publication to Mol. Gen. Genetics
- Donk, J.A.W.M. van der: The synthesis of RNA and proteins as a function of the time of pollentube-style interaction after cross- and selfpollination of *Petunia hybrida* L., sent for publication to *Planta* (Berl.)
- Donk, J.A.W.M. van der: The study of protein synthesis in styles of *Petunia hybrida* L. using egg-cells of *Xenopus levis*, will appear in Incompatibility Newsletter 4

All members of the team participated in the meeting of the Incompatibility Contact Group of The association EURATOM-ITAL on April 26, 1973 in Brussels and in the meeting of the Mutation Breeding Contact Group on November 6-8, 1973 in Grfnbach. Each member of the team presented his latest results during these meetings.

Prof.Dr. Linskens participated in the following meetings:

- Transport Symposium of the Polish Academy of Sciences and the Esna-meeting, Warsaw-Jablonna, May 1973
- Incompatibility in higher plant, symposium of the Linnean Society Cambridge, October 1973
- Embryology of Plants, Moscow, December 1973

Drs. van der Donk attended the 15th meeting of the deutsche Gesellschaft für Genetic on the genetics and physiology of incompatibility in plant and animal. Marburg/Lahn, May 1973

Prof.Dr. Linskens is a member of the International Scientific Advisory Council (ISAC-ITAL) and attended its meetings in Wageningen (June 1973) and Brussels (November 1973)

Contracting Research Institute: Department of Plant Breeding
Agricultural University,
Wageningen, the Netherlands.

Number of contract : 094-72-1 BIAN s/c 003

Head of the research team : Prof.Dr.Ir. J. Sneep

General subject of the contract: The use of mutations and mutation techniques in
mainly fundamental plant breeding research.

General description of the project:

1. Mutation Research in potato (Solanum tuberosum L.) (van Harten, Bouter)

In 1973 special attention was paid to establishing further correlations between morphological and histological observations by studying tuber resp. flower characteristics and microscopic sections from irradiated shoot apices of periclinal chimeras. Previous ideas about perforations, reduplications and chimeric structures were partly confirmed and extended. Work on the production of a new diploid test-clone progressed slowly. A suggested method for the production of adventitious sprouts (Jørgensen method) was tried and rejected. Some practical experiments concerning yield and disease resistance were continued on a limited scale.

2. a. Sporophytic Incompatibility in Lobularia maritima (Bos, Heemstra).
b. Gametophytic Incompatibility and related problems in Solanum spp. (Hermsen, Ramanna).

Results for eacht project are described under B.

3. Dwarf-rust in barley, mutation breeding for disease resistance (Parlevliet, van Ommeren).

Results are described under B.

Results of the project: Potato (*Solanum tuberosum* L.)

Leader of the team and co-worker: A.M. van Harten, H. Bouter

Title of the project: Mutation research in potato

1. Regeneration of X-irradiated potato material.

1.1. To study the behaviour of 3 histogenic layers after irradiating potato meristems, the stable monecto-chimeric mutant EM52 (tuber constitution L_1 genetically yellow, $L_2 + L_3$ genetically red) with red splashed tubers and white flowers was selected from the homohisti red-tubered and lilac-flowered cv Desirée.

Two additional trials were performed to complete last year's information. In the first trial single eyepieces of tubers of this mutant were irradiated with 0, 500, 1000, 2000 and 4000 rad (dose rate 250 rad/min) and studied both morphologically in the greenhouse and microscopically from micro tome sections of irradiated shoot apices. In the second experiment the phenomenon of layer replacement was studied morphologically on 2 related clones: EM52 (red-splashed monecto-chimera) and E52 (a fully red clone, derived from L_2 and L_3 tissue of EM52). Four dosages of X-rays (400, 800, 1600, 2400 rad + control), 2 dose-rates (20 and 200 rad/min) and 2 temperatures (12° and 20° C) were used.

Results are given in tables 1 and 2.

Table 1. Frequencies of tuber colour changes to (sectored-) red and yellow vM_1 tubers of X-rayed, red-splashed tubered EM52.

Objects	No of studied vM_1		% sectored-/red in		% yellow in	
	plants	tubers	plants	tubers	plants	tubers
Control	35	107	0	0	0	0
500 rad	37	121	0	0	0	0
1000 rad	33	95	3	1	0	0
2000 rad	35	123	31	16	1	6
4000 rad	21	92	57	50	19	12

Table 2. Frequencies of tubercolour changes from EM52 (red-splashed to red and yellow) and E52 (red to red-splashed and yellow).

Objects	% surviving vM_1 plants		% tubercolour changes in				% yellow tubers in			
	EM 52	E52	plants		tubers		plants		tubers	
			EM52	E52	EM52	E52	EM52	E52	EM52	E52
Control	96	97	9	0,7	3	0,7	0	0	0	0
400 rad	99	89	17	0,7	9	0,6	0,3	0	0,2	0
800 rad	81	88	19	1,9	9	1,1	1,4	0	0,6	0
1600 rad	85	87	33	2,3	16	1,8	1,1	0	0,4	0
2400 rad	86	81	50	5,8	25	2,8	2,1	0	0,5	0
Σ 24 rad/min	89	77	33	1,8	16	1,8	2,2	0	0,8	0
Σ 240 rad/min	85	96	27	1,7	13	1,7	0,2	0	0,1	0

The above results highly corroborate the assumption of layer perforations, reduplications and re-differentiation to prove that L_1 is genetically yellow.

Histological observations suggest differences in mutability between histogenic layers in potato, or perhaps between red and yellow tissue.

1.2. In a small experiment with the clone EM52 the effects of dry and wet irradiation were compared. Irradiation under water gave a lower radiosensitivity and an increase of perforations. This point will be re-investigated.

1.3. The new diploid basic clone containing (very probably) 6 monofactorial marker genes in heterozygous condition has been subjected to some preliminary irradiation experiments. Results showed a high radiosensitivity but rather low mutation frequencies. Unfortunately the clone proves to be very susceptible for spider-mite attacks.

1.4. Adventitious sprout formation from detached leaves and leaflets has been studied now for three years, using more than 70.000 leaflets. Results were disencouraging. In vitro-work with epidermal leaf tissue did not start yet, because of lack of accomodation. Another method of producing (adventitious?) plantlets from detached rooted sprouts (the so-called Jørgensen method) was tried, but had to be rejected as sprouts (and consecutively tubers) did not originate from L_1 but mainly reproduced the three-layered structure of the monecto chimeric base clone EM52 (see before) on which experiments were performed.

2. Screening for resistance to diseases.

A rather significantly increased resistance against leaf-roll virus was found in several irradiated series during several years. Results will soon be worked out and published. Y-virus investigations showed greatly deviating results for 1973 as compared with previous years. The experiments will be continued.

3. Yield experiments.

The 1972 results showed some promising correlations with former trials. Experiments will be continued.

4. Maintenance and multiplication of clones.

About 1200 sub-clones derived from irradiated plantmaterial of the cultivars Bintje, Burmania and Desirée and of some dihaploid and diploid material are maintained in the new polders under favourable conditions to serve as basic material for further experiments in Wageningen and for demonstration purposes.

5. Generative programme.

Investigations to produce a vigorous fertile testclone, heterozygous for several characters are continued. Progress is slow.

6. Programme for 1974 and later years.

The programme will not deviate considerably from the one reported for 1973.

Publications

- van Harten, A.M. and H. Bouter.
Dihaploid potatoes in mutation breeding: some preliminary results. Euphytica 22 (1973): 1-7.
- van Harten, A.M.; H. Bouter and B. Schut.
Ivy leaf of potato (Solanum tuberosum), a radiation-induced dominant mutation for leaf shape. Radiation Botany, 1973, Vol. 13 (7 pp).
- van Harten, A.M.
Association Euratom-ITAL Annual Report 1972 (1973): 18-20.
- van Harten, A.M.
Report Meeting Euratom Mutation Breeding Working Group, Casaccia (Italy). Internal Report 1972.
- van Harten, A.M.
Annual Report Biology Programme Euratom 1972 (1973): 572-574.

Results of the project : *Lobularia maritima* (L.) Desv.
Leader and co-worker : I. Bos, G. Heemstra.
Title of the project : The population genetics of the S alleles of a
sporophytic incompatibility system.

The analysis of the relations of S-alleles in a heterozygous S-genotype has been finished for 9 different S-heterozygotes. This analysis was based on reciprocal backcrossing of Sweet Alyssum (*Lobularia maritima* (L.) Desv.) plants, obtained through forced selfing, and the appropriate parent (HARUTA's method). Because of the considerable variation in (in)compatibility (measured as fruitset) between parent and selfed progeny, it was not possible to guarantee on this method alone the correctness of the determination of the relation (dominance or codominance in the pollen producing tissue and in the stigma) and therefore the few I_1 plants with the clearest (in)compatibility expression were subjected to a diallel cross. This is a slight modification of FABIG & NOWAK's method of analysis: the number of I_1 plants to be crossed in the diallel set of crosses is diminished through selection based on the results of the HARUTA analysis. The results of both types of determination of the relation of S-alleles should be the same and confirm each other.

Publication in 1973.

BOS, I. Population genetics of the S-alleles of a sporophytic incompatibility system. Incompatibility Newsletter 3 (1973): 67-70.

Leader : Dr.Ir. J.G.Th. Hermsen.

Title of the project : Investigations on self-compatibility in induced dihaploids of Solanum tuberosum L.

In the 1973 report an interchromosomal duplication of a mutated S-allele is supposed to cause self-compatibility in the dihaploids G254 and B16. Pollen carrying the duplication tended to grow more slowly in the styles than normal pollen (certation). On the basis of the supposed S-genotype of cv. Gineke it was expected that 50% of the Gineke dihaploids should be self-compatible.

In 1973 we first tried to identify plants which are homozygous for the duplication carrying S_1^1 . This was done by testing the ratio self-incompatible (s.i.) to self-compatible (s.c.) in the progenies of the cross G254-selfed x G609. In G254-selfed 50% of the plants should be duplication homozygotes ($S_1^1 S_1^1$) and produce only s.c. plants after crossing with the s.i. dihaploid G609. The remaining 50% should be duplication heterozygotes, which after crossing with G609 are expected to segregate 1 s.i. : 1 s.c. As only 1 : 1 ratios were found, it was hypothesized that duplication homozygotes either are not formed or are lethal.

In order to collect additional information about this question 500 seeds of G254-selfed were sown in petri-dishes; 488 seeds germinated and were transferred into soil. Only 140 (= 29%) normal plants were obtained, for 305 died in the cotyledon stage and 43 were virescent. These numbers may be explained in two ways. Firstly: four independent recessive (sub)-lethal genes segregate ($\chi^2 = 4,67$; $P = 0.10-0.05$); Secondly: the duplication homozygotes (expected number 244) are lethal. The remaining 244 plants then comprise 140 normals, 61 lethals and 43 virescent plants. With one recessive lethal gene and one for virescens the expected numbers are 137.1 normal, 60.9 lethal and 43 virescent respectively ($\chi^2 = 0.22$; $P = 0.90$). These results support the view that duplication homozygotes are lethal.

Certation between pollen with and without the duplication was re-investigated by determining the ratios s.c.:s.i. in six F_1 hybrids mentioned in table 1.

The ratios obtained in 1972 are included for comparison.

Table 1. Numbers of self-compatible (s.c.) and self-incompatible (s.i.) plants in six F_1 -populations in two consecutive years.

Cross	1972		1973	
	s.c.	s.i.	s.c.	s.i.
G254 x B16	22	7	26	8
B16 x G254	26	3	24	11
G254 x G609	17	21	18	21
G609 x G254	10	28	19	21
B16 x G609	20	17	20	20
G609 x B16	14	21	18	21

Two crosses, viz those with G254 as the male parent, B16 x G254 and G609 x G254, show results which are different in 1972 and 1973. For an explanation of the 1973 ratios there is no need to assume certation, if duplication homozygotes are lethal. However the ratios 26:3 and 10:28 obtained in 1972 cannot be explained on this basis. Only when both certation and viability of duplication homozygotes are assumed, the ratios of 1972 fit in with those of 1973. However the assumption of viable duplication homozygotes cannot be reconciled with the above evidence for lethality of these homozygotes. Obviously this experiment has to be repeated using larger populations.

The test of self-(in)compatibility in Gineke-dihaploids has been hampered by the general occurrence of male sterility and poor flowering in 1973.

Publication.

Hermsen, J.G.Th., 1973. Genetic analysis of self-compatibility in primary dihaploids from a potato cultivar. Potato Research 16:316.

Leader : Dr.Ir. J.G.Th. Hermsen. Co-worker: Dr. M.S. Ramanna.

Title of the project: Unilateral incongruity and unilateral male sterility in interspecific Solanum crosses.

The results of recent investigations in Solanum and Lycopersicon suggest the absence of direct genetic and physiological relations between incompatibility as such and interspecific incompatibility. Consequently the term "incongruity" has been introduced to replace the term "interspecific incompatibility".

Unilateral incongruity (non-crossability in one direction only) and unilateral male sterility occur when crossing S. verrucosum with diploid S. tuberosum. Owing to unilateral incongruity this cross only succeeds when S. verrucosum is the female parent. The F_1 's obtained in this way exhibit plasmon-genic male sterility. With S. verrucosum as the male parent the pollen tubes are inhibited in the S. tuberosum styles. This inhibition is genetically determined. Therefore a search was made for diploid S. tuberosum genotypes which accept S. verrucosum pollen (no inhibition). Such genotypes would enable the production of male fertile F_1 hybrids S. tuberosum x S. verrucosum. Three such so-called acceptor genotypes were detected recently.

In order to study the genetic basis of acceptance several crosses were made among acceptors (A x A), between acceptors and non-acceptors ($A \times NA$) and among non-acceptors (NA x NA), and the progenies tested for acceptance of S. verrucosum pollen. The ratios found in sixteen progenies together with a test of two genetic models are presented in table 1.

Table 1. Two genetic models to explain the observed ratios acceptor (A): non-acceptor (NA). Models explained in text.

Cross	Type parents	Observed		Expected			
		A	NA	Model 1		Model 2	
				A : NA	P	A : NA	P
GB39 selfed	A	6	0	1 : 0	1	1 : 0	1
GB53 selfed	A	14	5	1 : 0	0	3 : 1	> 0.95
BG30 selfed	A?	4	13	1 : 3	> 0.70	1 : 3	> 0.70
BG41 selfed	NA	0	52	0 : 1	1	0 : 1	1
GB47 selfed	NA	3	11	1 : 3	> 0.90	3 : 13	> 0.90
G254 selfed	NA	1	12	1 : 15	> 0.90	3 : 13	> 0.35
B16 selfed	NA	7	27	1 : 3	> 0.50	3 : 13	> 0.65
GB47 x BG41	NA x NA	0	11	0 : 1	1	0 : 1	1
G254 x B16	NA x NA	10	51	1 : 7	> 0.35	3 : 13	> 0.65
GB53 x G254	A x NA	16	23	1 : 3	< 0.05	3 : 5	> 0.65
GB39 x B16	A x NA	9	11	1 : 1	> 0.65	1 : 1	> 0.65
GB53 x B16	A x NA	8	9	1 : 1	> 0.90	3 : 5	> 0.40
GB39 x BG41	A x NA	0	25	0 : 1	1	0 : 1	1
GB47 x GB39	NA x A	12	15	1 : 1	> 0.55	1 : 1	> 0.55

Model 1 : Non-acceptance is based on two independent dominant genes. Acceptance is based on one dominant gene whose activity is suppressed by a dominant inhibitor gene. The relatively small populations are due to segregating lethal genes. In order to further elucidate the genetics of acceptance additional crosses have been made, including also one newly found acceptor from S. tuberosum, spp. andigena. As a consequence of our finding of nearly 100 acceptor genotypes in 1973, many fertile F₁ hybrids with S. verrucosum are now available as starting material for resistance breeding.

Pollen tube growth was investigated in different cross combinations. In compatible and in congruous crosses the pollen tubes grew normally, whereas inhibition was observed after incompatible pollinations (gradual thinning bundle of pollen tubes) and when incongruity was involved (mostly a sudden growth stop of all pollen tubes just below the stigma).

One set of reciprocal hybrids between S. verrucosum and diploid S. tuberosum was studied carefully for occurrence and type of male sterility. The results are included in the publication mentioned below.

Publications.

Ramanna, M.S. and J.G.Th. Hermsen, 1974.

Unilateral "eclipse sterility" in reciprocal crosses between
Solanum verrucosum Schlechtd. and diploid S. tuberosum L.
Euphytica. In press.

Title of the project : Mutation breeding for disease resistance. Dwarfrust in barley.

Leader of the team and co-worker : J.E. Parlevliet, A. van Ommeren.

To investigate the possibilities of mutation induction of partial resistance against dwarfrust, Puccinia hordei Otth, in barley seed of the cultivar "Minerva" has been treated in 1973. Dry seeds received 0 or 15 Krad x-rays. Seeds soaked for 20 hrs in running water at 12-13° C were treated during 6 hrs at 24° C with 25,50 or 75 m mol E.M.S. after which the seeds were washed and planted. The M₁ plants showed the usual reduction in vigour of growth and fertility. The irradiated plants showed hardly a decrease in emergence percentage; the growth, however, was clearly less vigorous. The E.M.S. treatments were sown in jiffy-pots and planted in the field after 3 leaves had been formed. Table 1 shows the reduction in growth and fertility.

Table 1. Percentage of emergence, seedling height 20 days after sowing, and number of seeds per ear of EMS and x-rays-treated "Minerva" plants.

Treatment	% of emergence	seedling height	seeds per ear
0 m mol EMS	93	21.5	15.0
25 m mol EMS	90	18.5	12.0
50 m mol EMS	79	14.0	4.2
75 m mol EMS	70	8.5	5.6
0 Krad x-rays	-	-	15.3
15 Krad x-rays	-	-	6.1

Although the 75 m mol EMS treatment had slightly more seeds per ear than the 50 m mol EMS treatment it should be realized that in the field considerably more plants of the latter treatment survived than in the former. The real level of sterility therefore might be somewhat lower especially in the 75 m mol EMS treatment.

Associato della Commissione: COMITATO NAZIONALE ENERGIA
NUCLEARE
Laboratorio Applicazioni Agricoltura

N° del contratto: S/C 004 094-72-1 BIAN I

Capo del gruppo di ricerca: prof. A. BOZZINI

Tema generale del contratto: Application of mutagenesis
for the improvement of some economically interesting
characteristics in higher plants.
Fundamental and applied research with the gameto-
phytic system of incompatibility in higher plants.

Breve descrizione generale dei lavori compiuti:

The researches carried out in 1973 were principally oriented in three directions:

- 1) spontaneous and induced mutations at the S locus: a comparative analysis on the nature and origin of constructive (generation of new alleles) and negative (genetic losses) mutations.
- 2) Establishment of linkage relationships with the S-locus of self-incompatible plants and identification of the S-bearing chromosome.
- 3) Selection and analysis of spontaneous and induced mutations for disease resistance in two cultivated species.

Risultati del progetto n° 2

Capo del progetto e collaboratori scientifici:

D. de Nettancourt (previously at the Casaccia and now in Brussels),
M. Devreux (Casaccia), A. J. G. van Gastel (Wageningen), U. Laneri,
B. Donini (Casaccia), G. Bredemeyer (Wageningen).

Titolo del progetto:

The spectrum of spontaneous and induced mutations at the S-locus:
a comparative analysis on the origin and nature of constructive
(generations of new alleles) and negative (genetic losses)
mutations.

1. Analysis of mutation spectra at the S-locus of *N. alata*: see report
of the Association EURATOM-ITAL.

2. The detection and origin of spontaneous mutations at the S-locus of
inbred plants of *L. peruvianum*

In order to elucidate the mechanism operating when inbred plants of
L. peruvianum spontaneously generate new S-alleles (de Nettancourt et
al, Theor. Appl. Genet. 1971), the same S₁ and S₂ alleles which had
been studied previously in one inbred genetic environment were placed,
after a complete diallel analysis, test-crosses and identity tests, in
several different genetic backgrounds for ascertaining the influence
of such backgrounds on the frequency and specificity of spontaneous
constructive mutations at the S locus. As the S-genotype of the stami-
nate parent which was used for introducing modifications in the gene-
tic background is known (S₄S₅), the same material will permit the de-
tection of an eventual relation between mutation specificity and the
identity of the S-alleles which have been associated, one generation
earlier, to S₁ and S₂. In 1972, the work had involved the conduction
of a diallel test (20 plants) in the progeny of S₁S₂ x S₄S₅ crosses,
the determination of each of the 4 genotypic classes present in the
progeny and the production, by means of crosses between S₁S₄ or S₁S₅
and S₂S₄ or S₂S₅ individuals, of S₁S₂ genotypes in new genetic back-
grounds. Such S₁S₂ plants were submitted in 1973 to obligate inbreed-
ing and 137 seeds were obtained from 1.451 hand-pollinations after
heat shocks and hormone treatments. These seeds will be sown in 1974
and the resulting populations submitted to detection tests (recipro-
cal crosses to S₁S₂) and to ancestry tests (reciprocal crosses to
S₁S₄, S₂S₅ and S₁S₅) to find out if a new specificity is present and
if this new specificity is identical to S₄ or S₅.

3. The induction of self-compatibility in allogamous species

With the practical aim of detecting self-compatible mutants in varieties of *Prunus avium* which are adapted to the climatic conditions of Italy, extensive screening tests were carried out on the morphological mutants previously induced by means of radiation treatment. Up to now, not a single self-compatible individual has been found. In 1974, special attempts will be made to induce self-compatible mutations in the two "compact mutants" which have been recently selected and which appear so promising for cultivation in Italy.

Using *Lycopersicum peruvianum* and the self-incompatible hybrid *esculentum x peruvianum* in which electron microscopy has shown (de Nettancourt et al, 1973 and in press) that the formation of a concentric endoplasmic reticulum (CER) in the pollen tubes was one of the first symptom of the self-incompatibility reaction, attempts were made to use abscissic and giberellic acids for breaking down self-incompatibility. The motivation for such experiments stemmed from the recent finding that these chemicals could lead to an elimination of the CER and to an initiation of metabolic activity in dormant potato buds. Several hundreds peruvianum flowers were sprayed 48 hours before incompatible pollinations and relatively high fruit sets (ranging from 10 to 100 %) and seed-sets (ranging from 1 to 50 seeds per fruit) were recorded in the G.A. series (as compared to practically none after application with abscissic acid or distilled water). No seeds could be obtained, however, in the cases where giberellic acid was applied to the interspecific hybrid. These results, if they are confirmed, suggest that:

- giberellic acid, via a possible action on the circular endoplasmic reticulum, is an effective chemical for inducing temporary self-compatibility,
- sterility barriers are superimposed to self-incompatibility in the interspecific hybrid which prevent applications of G.A. to result in seed formation upon self-pollination.

Risultati del progetto n° 3

Capo del progetto e collaboratori scientifici:

D. de Nettancourt (Bruxelles), A. J. G. van Gastel (Wageningen),
F. Carluccio (Casaccia)

Titolo del progetto:

Establishment of linkage relationships with the S-locus of self-incompatible plants and identification of the S-bearing chromosome.

As in 1972, this problem has been tackled at the cytological (Casaccia) and the genetical (see report by A. J. G. van Gastel, Association EURATOM-ITAL) levels.

The work carried out at the Casaccia can be subdivided into the two following parts:

1. Analysis of the mechanism leading to the formation of self-compatibility mutations with a centric fragment in *N. alata*

In 1973, the cytogenetical analysis of *N. alata* individuals which are unstable at the S-locus was extended on a very large scale. There is absolutely no doubt that the original clone and part of its progenies are heterologous for chromosome 3 and that one of the chromosomes in the pair carries a duplication of the satellited region. Very clear evidence, from analysis of more than one hundred meristematic cells in root tips, has been obtained which shows that the duplicated region can detach itself from the short arm of chromosome 3 and become a free fragment very much similar to the centric fragment characterizing certain types of self-compatibility mutants. Hence, it does not only appear that the mechanism by which accessory chromosomes are formed has been elucidated but it also seems that the origin of self-compatibility fragment is now known.

The results of a segregation test for the modified chromosome 3 and the S-locus (S_4 as labelled by a stylar part mutation) indicated however that the S-locus, as far as stylar specificity in the style is concerned, is not located on chromosome 3. If one accepts the view that chromosome 3 is the origin of self-compatibility promoting centric fragment, this finding implies that either the specificity segment governing the incompatibility reaction in the pollen is not located on the same chromosome as the specificity segment active in the style or that the centric fragment does not carry an S-locus (as assumed by the competition theory) and does not even originate from the S-bearing chromosome (as assumed by the restitution theory).

2. The identification of the S-bearing chromosome of *L. peruvianum* by means of the trisomic method

Triploids have been produced after crosses between self-compatible tetraploids and self-incompatible diploids. Although these triploids appear to be essentially self-incompatible (which casts doubts on the validity of the competition theory and on the possibility to use the trisomic method for identifying the S-bearing chromosome), backcrosses have been made to the diploid parent and a limited number of seeds were obtained which will be sown early in 1974.

Complement to projects n° 2 and n° 3:

The ultrastructure and the genetics of self- and cross-incompatibility in an interspecific hybrid between self-compatible *L. esculentum* and self-incompatible *L. peruvianum*

(D. de Nettancourt, M. Devreux, U. Laneri)

In 1973, thanks to the very valuable cooperation of the laboratory of electron microscopy at the University of Siena (Professor G. Sarfatti, Drs. Cresti and Pacini), a detailed analysis was made of the genetical and ultrastructural features of incompatibility in an interspecific tomato hybrid produced at the Casaccia.

It was found, in the course of this study, that fluorescence techniques and electron microscopy allowed, after self-pollination of the hybrids or after reciprocal crossing between the hybrid and the parental species, a distinction between pollen tubes inhibited by an unilateral incompatibility reaction and pollen tubes inhibited by a self-incompatibility reaction. The observed differences, assumed to be real and reliable, were such that it was possible to demonstrate that unilateral incompatibility in esculentum pollen tubes is governed by a single gametophytic factor which is either linked or allelic to the S-locus. The finding was discussed in relation to the reports recently made (see Hogenboom 1973) that unilateral incompatibility is controlled, in peruvianum styles, by a number of different dominant genes and the conclusion was reached that these dominant genes, the S-locus of self-incompatibility and the gametophytic factor regulating the unilateral incompatibility reaction in esculentum pollen belong to the same linkage group.

The strong sterility barriers which prevent practically all backcrosses between the hybrid and the parental species were shown to be independent of the factors regulating stylar incompatibility. *L. peruvianum* is heterozygous for the sterility genes which prevent fertilization or embryo formation when the interspecific hybrid is crossed, as pistillate parent, to different accessions of *L. peruvianum*. One peruvianum stock was found which, as a pollinator, was highly cross-fertile with the hybrids.

The presence of a concentric endoplasmic reticulum in inhibited pollen tubes was observed to be a constant feature of both the self- and the unilateral incompatibility reactions and was interpreted as an indication that incompatibility leads to a general cessation of protein synthesis.

Although incompatible tubes resemble very much, in this respect, the pollen tubes cultured in vitro, the conclusion was reached that the inhibition of pollen tubes in incompatible styles does not result from an absence of growth promoting substance but from the presence of a metabolic inhibitor.

PUBLICATIONS IN 1973

D. de Nettancourt, M. Devreux, A. Bozzini, M. Cresti, E. Pacini and G. Sarfatti

ULTRASTRUCTURAL ASPECTS OF THE SELF-INCOMPATIBILITY MECHANISM IN LYCOPERSICUM PERUVIANUM MILL

"J. Cell Sci." 12, pp. 403-419 (1973)

D. de Nettancourt, M. Devreux, U. Laneri, M. Cresti, G. Sarfatti, E. Pacini

ULTRASTRUCTURAL ASPECTS OF UNILATERAL INCOMPATIBILITY BETWEEN LYCOPERSICUM PERUVIANUM AND L. ESCULENTUM

"Caryologia" 25, pp. 207-217 (1973)

D. de Nettancourt

CYTOLOGICAL ASPECTS OF SELF-INCOMPATIBILITY IN LYCOPERSICUM PERUVIANUM AND NICOTIANA ALATA

"Genetics" 74, s 61 (1973)

PUBLICATIONS IN PRESS

D. de Nettancourt, F. Saccardo, U. Laneri, E. Capaccio, M. Westerhof and R. Ecochard

SELF-COMPATIBILITY IN A SPONTANEOUS TETRAPLOID OF LYCOPERSICUM PERUVIANUM MILL

Proceed. FAO-IAEA-EUCARPIA, Symp., Bari 1972

D. de Nettancourt, F. Carluccio, A. J. G. van Gastel

ON A POSSIBLE INVOLVEMENT OF CHROMOSOME 3 IN THE FORMATION OF SELF-COMPATIBILITY MUTATIONS IN NICOTIANA ALATA

Proceed. FAO-IAEA-EUCARPIA Symp., Bari 1972

D. de Nettancourt, M. Devreux, U. Laneri, E. Pacini, M. Cresti, G. Sarfatti

GENETICAL AND ULTRASTRUCTURAL ASPECTS OF SELF- AND CROSS-INCOMPATIBILITY IN INTERSPECIFIC HYBRIDS BETWEEN SELF-COMPATIBLE L. ESCULENTUM AND SELF-INCOMPATIBLE L. PERUVIANUM

"Theoretical and Applied Genetics"

A. J. G. van Gastel and D. de Nettancourt

THE EFFECTS OF DIFFERENT MUTAGENS ON SELF-INCOMPATIBILITY IN NICOTIANA ALATA
I. CHRONIC-GAMMA IRRADIATION

"Radiation Botany"

Risultati del progetto n. 4

Capo del progetto e collaboratori scientifici:

L.M. MONTI, F. SACCARDO, A. BOZZINI

Titolo del progetto: Selection and analysis of spontaneous
and induced mutations for disease resistance
in two cultivated species.

Descrizione dei risultati:

1. The project on disease resistance in tomato started in 1973 with the purpose to find or to induce resistance against two pathogenic agents for which no resistance is so far available.
 - 1.1. The pathogenic agents (Verticillium albo-atrum, race 2 and Phytophthora infestans, race T₁) have been obtained and the methods for their storage and propagation and the techniques for the infection and screening analysis between healthy and diseased plants have been set up (Tomarchio, in press).
 - 1.2. Irradiation of Italian tomato cvs. was performed by gamma treatments of both gametes following a procedure already set up in this Laboratory during a previous contract: this kind of a treatment allows the absence of a chimeric situation in the M₁ plants, so that a higher number of M₂ plants for each M₁ plant is available for the analysis. Several M₁ plants are now growing in the greenhouse. In the same time, about 8.000 M₂ seedlings coming from previous irradiations of the gametes of S. Marzano cv., were scored for V. Albo-atrum (race 2) resistance, but no resistant plant was found.
 - 1.3. Eight wild species of tomato were analyzed for vertical resistance to the two above mentioned parasites and to the other agents of the tracheomycosis in tomato (race 1 of V.albo-atrum; races 1 and 2 of Fusarium oxysporum f. lycopersyci). The results of the experiments (Monti, Saccardo and Tomarchio, in press) are reported in table 1: new sources of resistance

have been found against the pathogenic agents for which resistance is already available; for instance, three species (L. chilense, L. hirsutum and Solanum pennellii) were found to be resistant to race 2 of F. oxysporum, besides L. peruvianum, already known to be resistant to such disease.

No resistance has been found against race 2 of V.albo-atrum. As P. infestans race T₁ is concerned, two plants of L.hirsutum were found to be partially resistant to the fungus and studies have been started for a better evaluation of such a reaction.

Crosses between some of the wild species and L. esculentum have been also performed and the analysis of the F₁ plants confirmed the results obtained on the wild species themselves and the dominant behaviour of such resistances.

2. Triticum durum. Analysis for bunt (Tilletia triticoides) resistance has been performed using 162 mutant lines isolated from cv. Cappelli. Mutant lines were isolated from treatment with X-rays, fast and thermal neutrons, EMS. All mutants have been purified and their distinct morphological or physiological traits described in several generations. Cappelli control showed a moderate resistance (20% of attack) to the mixture of the extremely virulent races of Tilletia. About ten mutant lines showed no trace of infection, while about 40 lines are below 7% of infected plants. Some lines, however, showed a much higher level of susceptibility, which is reaching more than 40% of diseased plants. All set of mutants will be retested in 1973-74 in order to confirm the previous year's results. Results obtained so far seem to confirm the previous findings as to the possibility of modifying the bunt resistant reaction after treatment with mutagenic agents.

Abstract

New sources of resistance have been found among the wild species of tomato against Fusarium oxysporum races 1 and 2 and against race 1 of Verticillium albo-atrum. No resistance was found against race 2 of the latter fungus.

Two plants of L. hirsutum were found to be partially resistant to Phytophthora infestans race T₁.

Screening of M₂ seedlings for the V. albo-atrum race 2 resistance was started, but no resistant mutant plant was found so far.

Triticum durum. New mutant lines of Triticum durum from cv. Cappelli have been isolated as to higher and lower resistance to a race of bunt particularly virulent to this species. This material is to be tested again during 1973-74.

SPECIES	<u>Verticillium albo-atrum</u>		<u>Fusarium oxysporum F.Lyc.</u>		<u>Phytophthora infestans</u>
	race 1	race 2	race 1	race 2	
<u>L. esculentum</u> (S. Marzano)	S	S	S	S	S
<u>L. pimpinellifolium</u>	S	S	R	S	S
F ₁ (<u>L. esculentum</u> x <u>L. pimpinel.</u>)	S	S	R	S	S
<u>L. peruvianum</u> v. <u>humifusum</u> (<u>L. pissisi</u>)	S	S	R	S	S
<u>L. peruvianum</u> - line 1	R	S	S	S	S
<u>L. peruvianum</u> - line 2	R	S	R	R	S
<u>L. chilense</u>	R	S	R	R	S
<u>L. hirsutum</u>	S	S	R	R	S*
F ₁ (<u>L. esculentum</u> x <u>L. hirsutum</u>)	S	S	R	R	S
F ₁ (<u>L. esculentum</u> x <u>L. cheesmanii</u>)	S	S	R	S	S
<u>Solanum pennellii</u>	S	S	R	R	S
F ₁ (<u>L. esculentum</u> x <u>S. pennellii</u>)	S	S	R	R	S

TABLE 1 - Reaction to V. albo-atrum, F. oxysporum f. lycopersici and to P. infestans in different species of Lycopersicon and in Solanum pennellii

* two plants partially resistant

Publications

- BOZZINI A. - Analisi per resistenza alla carie di alcuni frumenti tetraploidi.- XV Conv. S.I.G.A., Genetica Agraria XXVII, 2-3: 93-100 (1973).
- BOZZINI A. - Analysis for bunt resistance in some tetraploid wheats.- EUCARPIA Meet. on Genetics and Breeding of durum wheat, Bari (Italy) (1973).
- MONTI L.M., F. SACCARDO, L. TOMARCHIO.- Resistenza alle tracheomicosi ed alla peronospora nel genere Lycopersicum ed in Solanum pennellii.- XVII Cong. S.I.G.A., Piacenza, Genetica Agraria (in press) (1973).
- MONTI L.M. and F. SACCARDO.- The modification by acute irradiation of recombination frequencies in tomatoes.- FAO/IAEA/EUCARPIA Conf. on Mutation and Polyploidy, Bari (Italy) (in press) (1972)
- MONTI L.M. and F. SACCARDO.- Radioinduced increase of recombination frequency in tomato.- Tomato Genetics Cooperative, 23: 24-25 (1973).
- SACCARDO F. and L.M. MONTI.- The isolation of aneuploids originated from induced unstable chromosome aberrations.- FAO/IAEA/EUCARPIA Conf. on Mutation and Polyploidy, Bari (Italy) (in press) (1972)
- TOMARCHIO L. - Fonti di resistenza e tecniche per la selezione di linee resistenti ad alcune malattie in pomodoro.- XVII Cong. S.I.G.A., Piacenza, Genetica Agraria (in press) (1973).

Associato della Commissione: ISTITUTO SPERIMENTALE CEREALICOLTURA
DI ROMA

N° del contratto: SC 005/094-72-1 BIAN - I

Capo del gruppo di ricerca : Prof. ANGELO BIANCHI

Tema generale del contratto: " Miglioramento genetico qualitativo delle proteine vegetali e in particolare del mais opaco".

Breve descrizione generale dei lavori compiuti .

BREVE DESCRIZIONE GENERALE DEI LAVORI COMPIUTI

Nel 1° anno di attività si è proceduto a irradiare semi di mais con dosi diverse di raggi X (4000 e 8000 R). I trattamenti sono stati effettuati presso il Laboratorio per le Applicazioni in Agricoltura del CNEN. I semi trattati consistevano nelle versioni normale e opaca della linea pure B 37. Per la linea B 37 o₂ sono stati trattati circa 2500 semi per dose, mentre per la versione normale sono stati trattati 800 semi per dose. Le semine sono state effettuate nella primavera del 1973 presso la sezione operativa periferica di Fiorenzuola d'Arda dell'Istituto Sperimentale per la Cerealicoltura di Roma.

Alla fioritura si è proceduto all'autofecondazione delle piante.

Nell'autunno 1973 le spighe autofecondate sono state raccolte, essiccate e sgranate.

Risultati del progetto n. SC 005/094-72-1 BIAN - I

Capo del progetto e collaboratori scientifici: A.BIANCHI
C.LORENZONI
M.STANCA
F.SALAMINI

Titolo del progetto: " Miglioramento genetico qualitativo delle
proteine vegetali e in particolare del mais opaco"

Descrizione dei risultati

DESCRIZIONE DEI RISULTATI

Nel primo anno di esecuzione di questo progetto non era previsto l'ottenimento di risultati di importanza scientifica relativi al progetto stesso dato che la finalità del programma è di ottenere variabilità genetica al livello degli effetti fenotipici del gene opaque-2 ($\underline{02}$). Vengono comunque riportate alcune osservazioni sul comportamento delle piante trattate e alcuni risultati che riguardano la consistenza numerica delle progenie ottenute dopo l'irradiamento. I trattamenti hanno influito drasticamente sulla germinazione dei semi e sulla vitalità e riproduzione delle piante trattate. Come previsto, la dose 4000 R è risultata vicina ai valori di DL 50 sia per la B37 normale che per la B 37 $\underline{02}$. La dose 8000 R ha invece ridotto pesantemente la germinazione dei semi e la vitalità delle piante ottenute. Le progenie ottenute da trattamento consistono di:

B 37 $\underline{02}$ (4000 R) 1079 spighe

B 37 normale (4000 R) 290 spighe

B 37 $\underline{02}$ (8000 R) 163 spighe

B 37 normale (8000 R) 50 spighe

Il n° dei semi portati da ciascuna spiga è variabile tra 8 e 150.

GENERAL DESCRIPTION

In the first year of activity, maize seeds have been X-ray treated (4000 and 8000 R). The mutagenic treatments were carried out at the Laboratorio per le Applicazioni in Agricoltura (CNEN) in Rome.

For the 4000 and 8000 R doses, 2500 seeds of the B 37 o 2 (opaque-2) have been treated, while for each X-ray dose, 800 normal seeds have been considered. In the 1973 spring the irradiated seeds were sown at Fiorenzuola (PC) where is located a section of the Experimental Institute for Cereal Crops.

At the flowering time the plants were self fertilized by hand pollination. In the 1973 autumn the obtained ears have been collected, dried and shelled.

DESCRIPTION OF THE RESULTS

During the first year of activity no result of scientific meaning was expected from this project, taking into account the finality of the same, namely the induction of genetic variability affecting the effect of the opaque-2 gene (o 2).

Here, however, we report some results about the behaviour and the number of the plants obtained from the irradiated seeds. The 4000 R dose resulted very near to the D L 50 either for the B 37 o 2 and its normal counterpart. The 8000 R dose reduced heavily the seed germination and the fertility of the plants. The number of progenies collected for each treatment was:

4000 R (B 37 <u>o</u> 2)	1079 ears
4000 R (B 37 normal)	250 ears
8000 R (B 37 <u>o</u> 2)	153 ears
8000 R (B 37 normal)	50 ears

Each progeny consisted of a number of seeds varying from 8 to 150.

Associato della Commissione:

N° del contratto:
006-1/094-72-I BIANI

Capo del (dei) gruppo(i) di ricerca:
Gian Tommaso Scarascia-Mugnozza

Tema generale del contratto:

Research of useful sources of resistance against *Erisiphe polygoni* and *Ascochyta* blight in *Pisum sativum*, by means of induced mutations.

In the first year of the contract, seeds of the varieties Sprinter (S) and Freezer (F) have been treated with physical mutagens (X rays; doses: 10 and 15 Kr; symbols: R₁ and R₂, respectively) and with chemical agents (diethylsulphate; doses: 1‰ and 1,5‰; symbols C₁ and C₂, respectively).

From about 5000 adult plants, seeds have been collected, keeping separately seeds produced on the stem and on the secondary branches. M₁ progenies have been also classified according to seed setting.

Greenhouse trials have been performed in order to set up a screening technique that could provide an efficient and quick means for selecting resistant pea plants.

A screening method was devised for large-scale inoculation. With this technique large number of plants can be evaluated, in a very short time, for powdery mildew resistance. Symptoms appear 4 days from inoculation and the final disease ratings are taken 6 days from inoculation.

Risultati del progetto n.

Capo del progetto e collaboratori scientifici:

Scarascia-Mugnozza G.T., Ciccarone A., Graniti A., Cirulli M. Pacucci G.,
Dellacecca V., De Pace C., Blanco A., Filippetti A., Montemurro A.

Titolo del progetto:

Induction of mutations for resistance to Erisiphe polygoni and to Ascochyta
blight in commercial varieties of Pisum sativum.

M₁ generation

In the first year of the contract, seeds of varieties Sprinter (S) and Freezer 69 (F) have been treated with physical mutagens (\times rays; doses: 10 and 15 Kr; symbols: R₁ and R₂, respectively) and with chemical agents (diethylsulphate; doses: 1‰ and 1,5‰; symbols C₁ and C₂, respectively). The germination rate ascertained in greenhouse test was around 25-30%. Thus, 3900 seedlings from treated seeds have been transplanted in field, together with 125 seedlings from untreated seeds.

Altogether, 5208 adult plants have been harvested (table 1). Seeds have been collected keeping separately seed produced on the stem and on the series of secondary branches, named from the bottom: B-C-D. Moreover, stem-progenies and branch-progenies have been discriminated according to the size of seed-setting. Table 2 summarizes the amount and characteristics of the M₁-progenies following the above mentioned criteria.

Observations of the presence of infertile or atrophic pods in M₁ adult plants have been carried out as an indication of the effectiveness of the mutagenic treatments. Table 3 shows that the phenomena of sterility and semisterility are directly correlated with increasing doses, both in chemical as well as in physical mutagenic treatments.

During 1973, greenhouse tests have been carried out to determine the host range of certain isolates of E. polygoni obtained from pea and other host plants collected from different areas of south Italy. Also, greenhouse trials have been performed in order to set up a screening technique that could provide an efficient and quick means for selecting resistant pea plants.

The preliminary results of cross inoculation tests seem to indicate that populations of E. polygoni isolated from pea plant possess a restricted range of host plant species. However, some pea isolates of the fungus exhibited a phenomenon of adaptation when inoculated sweetpea (Lathyrus odoratus L.).

A screening method was devised for large-scale inoculation; with this technique large number of plants can be evaluated, in a very short time, for powdery mildew resistance. Symptoms appear 4 days from inoculation and the final disease ratings are taken 6 days from inoculation.

M₂ generation

With the purpose of promoting the great expression of the variability induced by the treatments, all M₁-progenies with less than 40 seeds (i.e. those in which it should be presumed that more drastic was the mutagenic effect have been sown in field in December 1973.

From the remaining M₁ - progenies (i.e. those with 40 or >40 seeds) 20 seeds per progeny will be allotted for phytopathological screenings in greenhouse. The remaining seeds of those progenies showing cases of disease resistance will be sown again in greenhouse and in field, for: confirmation of the resistance, isolation of resistant or tolerant individuals, ascertainment of other morphological and/or physiological mutations, and for seed multiplication.

Table 1

Treatment	Adult plants
SC ₁	591
SC ₂	850
SR ₁	510
SR ₂	368
FC ₁	868
FC ₂	737
FR ₁	509
FR ₂	<u>775</u>
	5208

Table 2

M ₁ Progenies from	No. of seeds for progeny				Total
	< 15	15÷30	30÷50	> 50	
Stem	322	641	904	3288	5155
Branch B	302	732	1017	1287	3338
Branch C	153	395	626	634	1808
Branch D	68	193	267	294	822

Table 3

Treatment	Semisterile and sterile plants
	%
FC ₁	23,54
FC ₂	40,14
FR ₁	35,16
FR ₂	39,00
SC ₁	18,52
SC ₂	45,41
SR ₁	42,25
SR ₂	55,22
F test	0,19
S test	1,16

Contract partner
of the Commission: Prof. Dr. Werner Gottschalk
No. of the contract: SC 07/94-72-BIAN
Head of the research group: Prof. Dr. Werner Gottschalk
General theme of the contract:

"Gene physiological and biochemical investigations on radiation induced mutants of Pisum sativum."

The total seed protein content of a large number of radiation induced Pisum mutants was analysed and it was related to the seed production of these genotypes. In this way, it was possible to determine the protein production of the mutants. Furthermore, the seed proteins were qualitatively analysed by separating them into their main fractions and by determining their amino acid composition. These investigations were also carried out on some recombinants in comparison to their parental mutants in order to study the co-operation of mutated genes in protein production.

Besides the proteins, other storage substances of the seeds - the carbohydrates, particularly the sugars - were analysed.

The co-operation with foreign institutes was intensified. In this way, it was possible to test the capacity of the most prospective mutants of our collection comparatively under the climatic conditions of middle Europe and the semi-tropical and tropical conditions of India and Ghana.

The working conditions of our institute with regard to the biochemical evaluation of our material has essentially been improved by obtaining an amino acid analyzer and an ultracentrifuge.

Results of project No. 1

Head of the project and scientific co-workers:

- Prof. Dr. Werner Gottschalk
- Prof. Dr. Hermann Peter Müller
- Dr. Dagmar Müller

Titel of the project:

Protein production of Pisum mutants and recombinants in relation to protein quality

The protein content of the seed meal is a theoretical value which can easily be obtained; therefore, it is possible to compare a great number of mutants with one another. More important, however, is the protein production per plant because the seed production of the plants is considered in this value. The method used can be demonstrated comparing the data obtained from two mutants and its recombinant (fig. 1). Mutant 68C shows a seed production nearly similar to that of the initial line in a long years average, while mutant 1201A is essentially better. The recombinant R 350, homozygous for both the mutated genes, behaves as mutant 68C, that means as the worse parent. The three genotypes agree with one another and with the initial line with regard to the protein content in equal amounts of seed meal. Also with regard to the total amount of the essential amino acids nearly no differences could be found. The content of methionine- the limiting amino acid in legume proteins - of both the mutants is higher as compared with that of the control. This is also valid with regard to the recombinant, but in this case the recombinant agrees with the better of the two parents.

A completely different situation is obtained if also the seed production of the genotypes is considered. The productivity of mutant 1201A is obvious because the increased number of seeds per plant is not influenced by any negative factors. The recombinant, however, has not only a reduced seed number per plant, but also a reduced seed size. Therefore, its mean value for the character "seed weight per plant" is only about 90% of the corresponding mean of the initial line. A similar relation is found with regard to the protein production per plant. Mutant 1201A shows a particularly favourable situation as far as

- the seed protein content per plant,
 - the total amount of essential amino acids per plant,
 - and the content of methionine
- is concerned.

Mutant 68C shows a different situation for these parameters, but in general, it can likewise be regarded as positive in comparison to the initial line. The recombinant, however, does not reach the favourable properties of its parents. It has to be regarded negatively with the exception of its methionine production. Similar results were obtained for all the amino acids of some mutants and their recombinants.

A few mutants have been analysed with regard to the quantitative and qualitative situation of the sugars present in their seeds. They show a similar genetically conditioned diversity as reported for the proteins. There are certain indications that the germination behaviour of the mutants depends to some extent on their glucose content.

Results of Project No. 2

Head of the project and scientific co-workers:

- Prof. Dr. Werner Gottschalk
- Prof. Dr. Hermann Peter Müller
- Dr. Dagmar Müller

Title of the project:

a) The influence of climatic factors upon seed production and protein content

b) Cytogenetic investigations

a) Some of the most promising mutants of our collection show a very distinguishing response to different climatic conditions. This is not only generally valid with regard to the seed production, but also with regard to the quantitative and qualitative protein situation. This becomes clear by comparing the material grown at Bonn/Germany and at Udaipur/India. Mutants 46C (earliness) and 1201A (stem bifurcation) do not show any significant difference with regard to their total protein content under the moderate and subtropical conditions (fig. 2). The fasciated mutant 251A, however, shows striking differences. The protein content of its seed meal in Bonn is about equal to that of the initial line. In Udaipur, however, it is about 30 percent higher. Thus, the mutant is obviously able to utilize the Indian soil and/or the climatic conditions for its protein synthesis essentially better than the initial line.

In 1973, the evaluation of our mutants in India was not possible because the plants dried as a consequence of the lack of monsoon rainfalls. An early ripening mutant, however, was not only able to survive, but even to produce seeds. Thus, it was superior to its initial line as well as to the Indian local varieties. This is one of the very rare examples for the positive selection value of an experimentally produced mutant under extreme climatic conditions. The highest yielding mutant of our assortment - a fasciated genotype, which does not flower in India - was able to produce seeds under the tropical conditions of Ghana.

- b) The meiotic behaviour and fertility of seven radiation induced translocation lines was analysed. In six of them, two non-homologous chromosomes are involved. In the seventh mutant, three non-homologous chromosomes have been altered structurally forming a ring of 6 chromosomes in the first meiotic metaphase. The identification of the translocated chromosomes and the localisation of the translocation point was possible in one of these lines analysing its karyotype of mitotic metaphase chromosomes. Moreover, two tertiary trisomics were isolated derived from translocated plants. Four lines homozygous for the translocated chromosomes were developed from translocation-heterozygous strains.

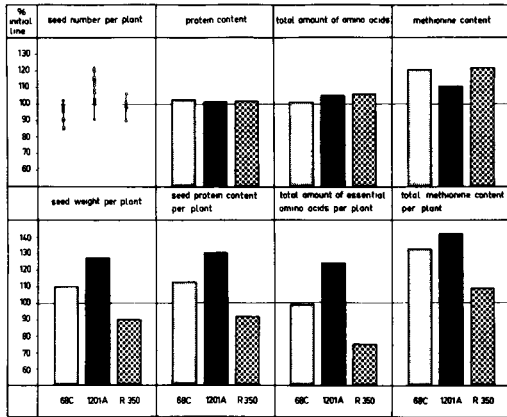

Figure 1: Comparison of some yield characters of the useful mutants 68C (increased ovule number), 1201A (stem bifurcation) and its recombinant R 350 (= 68C/1201A) as related to the corresponding mean values of the initial line.

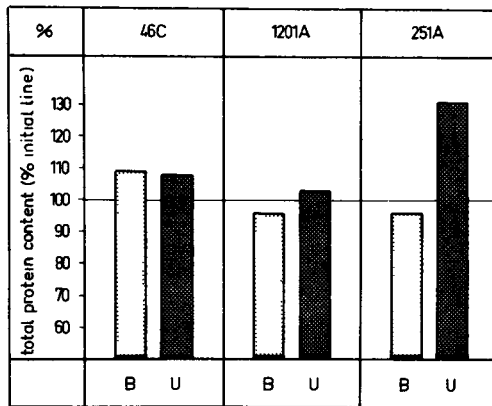

Figure 2: The protein content of the seed meal of mutants 46C (earliness), 1201A (stem bifurcation) and 251A (stem fasciation) cultivated at Bonn/Germany and at Udaipur/India.

List of publications

The following papers were published in 1973:

- Gottschalk, W.: The evolutionary qualification of some leaf mutants of *Pisum*.
Egypt. J. Genet. Cytol. 2, 219-238
- , - Two highly pleiotropic genes showing a nearly agreeing action on the plant.
Pisum Newsletter 5, 6-7
- , - The influence of the genotypic background on the action of the cochleata gene.
Pisum Newsletter 5, 8-9
- Gottschalk, W. and S.R. Baquar: Highly unstable translocations induced through irradiation in *Pisum*.
Cytologia 38, 327-336
- Gottschalk, W. and E. Hasenberg: The physiological capacity of some pea mutants in early developmental stages as related to their seed production.
Pisum Newsletter 5, 9-10
- Gottschalk, W. and M.M. Imam: The yielding capacity of mutants under different climatic conditions.
Ghana J. Sci. 13, 63-71
- Gottschalk, W. and G. Jahr: The pollen tube growth of some *Pisum* mutants.
Pisum Newsletter 5, 13-14
- Gottschalk, W. and S. Kumar: The yielding capacity of some pea mutants in Germany and India.
Pisum Newsletter 5, 11-12
- Gottschalk, W. and M. Milutinović: Trisomics from desynaptic mutants.
The Nucleus (in press)
- Gottschalk, W. and V. Milutinović: Untersuchungen zur Heterosis bei Selbstbefruchtungern.
I. Die Morphologie von Bastarden verschiedener *Pisum*-Mutanten im Vergleich zu den elterlichen Genotypen.
Genetika (Beograd) 5, 59-72
- , - -, -. II. Die Samenproduktion und andere Leistungsmerkmale von Bastarden verschiedener *Pisum*-Mutanten im Vergleich zu den elterlichen Genotypen.
Genetika (Beograd) 5, 117-134

- Müller, H.P.: Comparison of the amino acid composition of seed proteins with a "standard protein".
Pisum Newsletter 5, 35
- , - Content in globulins, albumins, and essential amino acids in seeds of pea mutants and recombinants.
Pisum Newsletter 5, 37
- Müller, H.P. and W. Gottschalk: Quantitative and qualitative situation of seed proteins in mutants and recombinants of *Pisum sativum*. Nuclear Techniques for Seed Protein Improvement; IAEA Vienna, 235-253
- Müller, H.P. and I. Henke: Comparison between the quantitative determination of amino acids in seed proteins by microbiological methods and by an automatic amino acid analyzer.
Pisum Newsletter 5, 38
- Weber, E. and W. Gottschalk: Die Beziehungen zwischen Zellgröße und Internodienlänge bei strahleninduzierten *Pisum*-Mutanten.
Beitr.Biol.Pflanzen 49, 101-126

Vertragspartner der Kommission:

Gesellschaft für Strahlen- und Umweltforschung mbH, München

Nummer des Vertrages: SC 08/94-72-1 BIAN

Leiter der Forschungsgruppe:

Prof. Dr. H. Gaul, Leiter der Abteilung Pflanzengenetik

Allgemeines Thema des Vertrages:

Production and selection of barleys with vertical and horizontal resistance against mildew (Erysiphe graminis)

In project 1, a collection of mildew resistant barley mutants was built up. It consists of plants with vertical as well as horizontal resistance. In addition to the existing mildew resistant mutants, new ones will be induced by chemical and physical mutagens. These experiments will provide information on the frequency of resistant mutants induced by different mutagenic treatments and on the efficiency of mutant production.

In project 2, genetic analyses of mildew resistant mutants are carried out. Both, the mode of inheritance and the number of resistance genes are studied. In some of the mutants mildew resistance belongs to a pleiotropic character complex. Is this the case, then the mutants are crossed with other varieties in order to demonstrate the possibility of separating mildew resistance from the undesired features controlled by the same gene. Such undesired characters are a.o. reduced grain yield, sterility, low tillering, and chlorophyll deficiencies.

Ergebnisse des Projekts Nr. 1

Leiter des Projekts und wissenschaftliche Mitarbeiter:

Dipl.-Ing.agr. V. Lind
Prof. Dr. H. Gaul

Titel des Projekts:

Selection of mildew resistant barley mutants following mutation induction

Darstellung der Ergebnisse:

Our collection of mildew resistant barley mutants includes 91 strains induced in eight varieties. In 1973, 59 mutants proved to be resistant against the mildew population to be found in our region. These mutants comprised infection types from 0 to 1; the scale of infection types running from 0 to 4 -- 0=highly resistant, 4=susceptible --. Twelve highly resistant mutants had necrotic and chlorotic flecking on the leaves. Similar leaf-fleckings are found with mutants having the ml-o gene on the chromosome 4. We have not yet investigated whether or not the genes in our mutants are identical to the ml-o gene. The relatively high frequency of resistant mutants with such a phenotype suggests that mutations mainly occur at one locus.

32 mutant strains were more or less susceptible; they comprised infection types from 2 to 4. In earlier tests these mutants were resistant only against the mildew race C₂.

By treating seeds with various X-ray doses and/or EMS-concentrations, new mildew resistant mutants will be induced. In 1973 three M₁-generations were grown. The original varieties "Villa", "Bido", and "Carina" have very good brewing quality; "Villa" has, in addition, a high yielding capacity. All of these varieties, however, are susceptible to mildew. The M₂-plants were subjected to the mildew population mentioned above in a greenhouse experiment. By inoculating the plants with a mixture of various mildew races, only those mutants could be clearly recognized that have developed resistance against several of the mildew races or at least against the most aggressive ones.

Uniform mutagenic treatments are being applied every year. Thus, our experiments will provide information on the frequency of induced mildew resistant mutants. This frequency may depend on the mutagens used, their dose and concentration. In addition, we shall also investigate whether or not the response of loci to different mutagens is the same. Studies with erectoides-mutants indicate the existance of interactions between mutagens and mutability of loci.

Ergebnisse des Projekts Nr. 2

Leiter des Projekts und wissenschaftliche Mitarbeiter:

Prof. Dr. H. Gaul
Dipl.-Ing.agr. V. Lind

Titel des Projekts:

Influence of the genetic background on the expression of mildew resistance

Darstellung der Ergebnisse:

In order to use mildew resistant mutants in breeding programmes effectively, information on the genes conditioning the resistance is necessary. In 1972 we have carried out a series of cross experiments. In 1973, the F_1 -generations of these experiments were sown in the field. Since all of the attempted cross combinations could not be accomplished in 1972 some crossings were only made this winter.

In backcrosses between mutants and their mother varieties the mode of inheritance of the genes conditioning the resistance reaction was studied. In all of the F_1 -generations the susceptibility of the mother varieties dominated, i.e. the F_1 -plants were mildew infested.

Twenty-four strains of our collection were crossed with each other in a diallel system. Twelve mutants induced in the varieties "Gerda", "Haisa II", and "Matura" have the chlorotic leaf-flecking mentioned previously. Crossing these mutants with each other results in the F_1 -plants having the same phenotype as the parents. We assume that the same gene mutated in all of the mutants.

Besides this recessively inherited gene, another gene was found among the Matura mutants. The latter also affects complete resistance but in addition, the plants have no chlorophyll deficiencies.

Results of the F_1 -analyses indicate that in crosses between several "Haisa II"-mutants three different recessively inherited resistance genes may be distinguished. Thus, three groups of mutants can be established. When we were crossing the plants within one group, the F_1 -generations obtained were resistant. On the other hand, when

mutants of different groups were crossed with one another, the F_1 -plants turned out to be susceptible.

We assume that in some of the mutants with chlorotic spots the leaf-flecking and the mildew resistance belong to one pleiotropic character complex. Therefore, we have initiated cross experiments with the aim of producing mildew resistant strains without any of the undesired features. The F_1 -generations were susceptible to mildew and had no chlorophyll deficiencies. Selection will be started in the F_2 -generation.

Vertragspartner der Kommission:

Gesellschaft für Strahlen- und Umweltforschung mbH, München

Nummer des Vertrages: SC 08/94-72-1 BIAN

Leiter der Forschungsgruppe:

Prof. Dr. H. Gaul, Leiter der Abteilung Pflanzengenetik

Allgemeines Thema des Vertrages:

Production and selection of barleys with increased protein quantity and improved protein quality

The increase of protein quantity (% crude protein in dry matter) and the improvement of protein quality (% lysine in dry matter) depend on three basic assumptions:

- (1) Sufficient genetic variation of both characters
- (2) A suitable selection scheme for one or more protein characters
- (3) Reliable analytical methods for screening induced mutants.

As regards the genetic variation of protein and lysine content, the variability of both characters was tested in a number of mutants originating from different commercial varieties.

The induced mutants were divided into macro- and micro-mutants according to preselection for yield, mildew resistance, earliness, fertility and some morphological traits, like culm length, spike density and tillering.

To make selection more efficient a scheme for simultaneous and/or separate selection of "% protein in dry matter", "% lysine in dry matter", and "% lysine in protein" was used in screening for superior mutants in both mutant groups.

The pre-screening for high protein and high lysine content was based on the DBC-method. The 10% best lines in each group were checked by Kjeldahl-tests for protein and by an enzymatic-colorimetric test for lysine content.

Ergebnisse des Projekts Nr. 1

Leiter des Projekts und wissenschaftliche Mitarbeiter:

Prof. Dr. H. Gaul
Dr. H. Walther
Dipl.-Ing.agr. V. Lind

Titel des Projekts:

Utilization of natural and mutagen-induced protein variability
in diploid barley

In 1973, the induced variability from 594 micro-mutants and 756 macro-mutants was tested for "% protein in dry matter" and "% lysine in dry matter". As a criterion for the biological value of the protein "% lysine in protein" was used. All macro- and micro-mutants originated from the commercial varieties Matura, Heisa II and Amsel. All mutants were preselected for economical characters other than protein quantity and quality, during at least 6 generations. Comparisons among the two groups of mutants and between mutants and the original varieties were made, using all three selection criteria simultaneously.

The following results can be summarized:

- (1) The induced total variability of protein and lysine content is comparable to the spontaneous variation, known from conventional breeding. In addition, however, some extremely deviating lines were selected in the upper and the lower ranges of variation for all three selection criteria.
- (2) In macro-mutants as well as in micro-mutants the variation of protein and lysine content is normally distributed with mean values close to their mother varieties. This is rather unexpected and possibly due to changes of other morphological characters related to protein quantity and quality.
- (3) The negative correlation between "% lysine in protein" and "% protein in dry matter" has been reported in the last years' results for a limited number of mutants. This is also confirmed for a large population of mutants with different sub-groups. For the total population the relation found was $r = - 0.72^{**}$. If protein and lysine measures are given on dry matter basis, the relation is positive with $r = 0.67^{**}$.

(4) Since the variation of the induced mutants exceeds the mean values of their mother varieties, selection of valuable mutants seems possible in both mutant groups. A selection rate of 10 % is obviously sufficient in pre-screening and detection of superior mutant lines improved in both, protein and lysine content.

(5) According to the type of distribution the protein content is thought to be inherited quantitatively and polygenic, the lysine content mono- or oligogenic. The environmental modification of these characters cannot be separated as yet from the genotypical variation on the basis of these results.

(6) The changes in protein and lysine content due to mutagenic treatment seem to occur more often in micro-steps than in macro-steps.

Ergebnisse des Projekts Nr. 2

Leiter des Projekts und wissenschaftliche Mitarbeiter:

Prof. Dr. H. Gaul
Dipl.-Landwirt W. Fried
Dr. H. Walther

Titel des Projekts:

Utilization of the protein variability of diploidized tetraploid barley

From previous results tetraploid barley strains are known to contain higher amounts of protein and lysine in dry matter. For a population of 120 tetraploid mutants these results were confirmed. The average difference in protein content between diploid and tetraploid mutants amounts to 4 %. For lysine content the average difference amounts to 0.1 %.

As for micro- and macro-mutants, the mean of the tetraploid mutant population is close to the mean of the original varieties. It seems, therefore, quite possible to select either for high protein or high lysine mutants, or for mutants high in protein and lysine.

Since the amount of lysine in protein is used as a measure of the biological value of protein, this selection criterion was checked in the diploid and tetraploid mutant groups. On account of the negative correlation between "% lysine in protein" and "% protein in dry matter", superior mutants with high amounts of protein and lysine in dry matter indicate a low content of "% lysine in protein". The tetraploid strains, therefore, produce in general protein with the lowest biological value.

Using a three-dimensional selection scheme, fields of covariation were differentiated to make selection possible including the biological value of the protein. According to this scheme, several superior lines were selected in all three mutant groups. The values of the best line in each group are presented for comparison:

Micro-mutants:	% protein in dry matter	14.3
	% lysine in dry matter	0.68
	% lysine in protein	4.75
Macro-mutants:	% protein in dry matter	20.8
	% lysine in dry matter	0.73
	% lysine in protein	3.50
Tetraploid mutants:	% protein in dry matter	19.1
	% lysine in dry matter	0.71
	% lysine in protein	3.70

Publications 1973:

- Fritz, A., Baumer, M., Ulonska, E., and Lenz, W.
A contribution to the analytical determination of the lysine content in barley
Nuclear Techniques for Seed Protein Improvement. Proc. Research Co-ordination Meeting IAEA/FAO/GSF, Neuherberg(Munich) 1972, IAEA, Vienna 1973
- Fritz, A., Ulonska, E., Baumer, M., and Lenz, W.
Die serienmäßige Bestimmung des Lysingehaltes von Getreideproteinen zum Zweck züchterischer Auslese
Bayer. Landw. Jahrbuch 50, Sonderheft 1, 145-153, 1973
- Gaul, H., Ulonska, E., Lind, V., and Walther, H.
Studies of selection for high protein and lysine content in barley mutants
Nuclear Techniques for Seed Protein Improvement. Proc. Research Co-ordination Meeting IAEA/FAO/GSF, Neuherberg(Munich) 1972, IAEA, Vienna 1973
- Lind, V., Gaul, H.
Mutagen induced mildew resistance in barley
Report, Meeting of the Mutation Breeding Contact Group, Association EURATOM/ITAL, Wageningen, Grünbach 6.-8. Nov. 1973 (in press)
- Ulonska, E., Gaul, H., Baumer, M., and Fritz, A.
Breeding on protein quantity and quality in barley
Nuclear Techniques for Seed Protein Improvement. Proc. Research Co-ordination Meeting IAEA/FAO/GSF, Neuherberg(Munich) 1972, IAEA, Vienna 1973
- Walther, H., Gaul, H., Ulonska, E., and Seibold, K.H.
Variation and selection of protein and lysine mutants in spring barley
2nd Research Co-ordination Meeting on the Use of Nuclear Techniques for Seed Protein Improvement, Ibadan, Nigeria, 1973, (in press)
- Walther, H., Gaul, H.
Production and selection of barleys with increased protein quantity and improved protein quality
Report, Meeting of the Mutation Breeding Contact Group, Association EURATOM/ITAL, Wageningen, Grünbach, 6.-8. Nov. 1973, (in press)
- Walther, H.
Methodische Untersuchungen zur Proteinbestimmung in induzierten Gerstemutanten
3. Arbeitstagung für Genetik der GSF, Grünbach, 24.-25. Mai 1973
GSF Bericht (in press)

Vertragspartner der Kommission: Gesellschaft für Strahlen- und Umweltforschung mbH. München, 8042 Neuherberg/München.

Nr. des Vertrages: SC 009/076-69-1; BJAN

Leiter der Forschungsgruppe: Priv. Doz. Dr. W. Kühn

Allgemeines Thema des Vertrages: Strahlenanalyse im Landbau.

In 1973, efforts concentrated on experiments to develop equipment for the mass determination of plantations. With help of a new scanning device measurements have been performed with a phantom of a corn field of "crop-equivalent" effective atomic number.

Rubidium-86 injections into different parts of trees and autoradiographic methods were applied to investigate the root system of trees in the soil.

In connection with a study on the diagnosis and therapy of dry rot Fomes annosus was grown in nutrient solutions of different concentrations of radioactive manganese (Mn-54). Experiments showed an influence on the growth rate of the fungus.

The equipment for investigations on evaporation and condensation of water vapor in soils was completed by a program-controlled temperature regulation providing an automatic simulation of the temperature inversions in atmosphere and soil in a day-night cycle.

Experiments with this set-up and Negev loess soil yielded results concerning depth and speed of penetration of water vapor originating from the atmosphere under the condition of daily temperature inversions. After the application of the equipment for measuring low moisture contents in thin soil layers in the laboratory during an IAEA training course, experiments were carried out in the Negev Desert in cooperation with the Institute of Botany of the Hebrew University, Jerusalem, in September 73.

Ergebnisse des Projekts Nr. 1

Leiter des Projekts und wissenschaftliche Mitarbeiter:

Dipl.Phys. H.P. Schätzler

Priv.Do. Dr. W. Kühn

Titel des Projekts:

Mass determination of plantations.

- 1) In 1973 a scanning device was completed to verify the results of preceding theoretical investigations. The most important part of the equipment is a strongly collimated beam of a 200 mCi Am-241 source at a length of 2.5 m to get approximately parallel rays (length of collimator: 20 cm, area source: $40 \times 10 \text{ mm}^2$, same collimator on the detector side). This beam scans the field in vertical and horizontal directions with help of synchronous motors. Measuring control and data compilation are performed by a multichannel-analyser operating in the MCS mode. The spatial resolving power can be improved by varying the length of the measuring intervalls. This measure is indispensable, as could be shown with step-like absorption profiles, when the absorption varies largely.

Investigations of the measuring geometry have proved that the cross section of the beam is almost constant along the path and matches the theoretically expected geometrical cross section of the absorbing material. The strongly collimated beam and the discrimination of the scattered radiation by spectroscopy guarantee the necessary exponential absorption for objects not smaller than the cross section of the beam. We have yet problems with boundary effects when measuring absorbing objects of still smaller size.

The penetrated mass of a certain unit area follows from the identity of the geometrical and the beam cross section. Summation over all area elements during scanning yields the total mass of the plantation.

Preliminary measurements were carried out with a phantom of a corn field (with an effective atomic number corresponding to real crop). The culm density was varied while the lengths of the culms

and spikes was kept constant. All experiments, performed so far, showed satisfactory agreement of the measured and the actual distributions of the weight per unit area.

2. Reasonable application of water and nutrients in semi-arid and arid cultures require the knowledge of the spatial distribution of the root system in vertical and horizontal directions. Undirected irrigation and fertilization is not economical. So far, root distributions have been determined by taking samples, which requires a tremendous amount of work and time especially with trees.

On the line of investigations concerning the soil-plant system we tried to determine the root system by radiometric means. For this purpose the accumulation and movement of Rb-86 (half-life: 18.6 d; E_{γ} : 1.08 MeV; E_{β} : 1.8 MeV) was studied with several-year old apple trees. The comparison of different techniques of injecting the radioactive Rb-solution proved the "scraped bark injection" to be far more effective than leaf or branch injections.

In the following experiments the Rb-activity in the root system was determined after applying solutions of different specific activities. Investigations of the Rb translocation from the stem into the roots showed that the accumulation of Rb in the roots starts about 1-2 days after injection and reaches a maximum after about 24 days.

The actual advantage of those experiments was the autoradiographic detection of the root system. Suitable Roentgen films placed into the soil during the mentioned time intervall show parts of the roots at certain distances to the stem with help of the β -radiation of Rb-86.

This method yields a rough but sufficient survey of the spatial distribution of the root system of a single plant and even a whole plantation if applied to representative trees. It saves a large amount of time and work and allows economical irrigation and fertilization. Furthermore, this technique is applicable for studies concerning infiltration resistances and aeration of different types of soils.

Ergebnisse des Projekts Nr. 2

Leiter des Projekts und wissenschaftliche Mitarbeiter:

Dipl. Phys. J. Handl

Titel des Projekts:

Studies on diagnosis and therapy of
dry rot in living trees.

After the development of a Roentgen-diagnostic method to determine dry rot in living trees the influence of manganese on the infection of trees by fungi, especially by Fomes annosus, was studied.

It is known that the decomposition of wood in trees is more severe with Fomes annosus when the manganese concentration is higher. To investigate a possible correlation between Mn-content and infection more experiments were carried out with the 250-year old Lime trees, which have been diagnosed with x-rays during the last report period. The manganese content of samples of wood from sick and healthy parts of those trees was determined by activation analysis. It showed that in most cases the Mn-content is higher in sick wood than in healthy parts. This result suggests the possibility to influence the growth of fungi and consequently the decomposition of wood, if radioactive manganese is incorporated into infected parts.

Therefore, Fomes annosus was grown in nutrient solutions of different concentrations of inactive and active manganese (Mn-54). Experiments were carried out in several series of 4 different activities each, resulting in radiation doses between 0.8 R and 8 R per day. The results indicate that the growth rate of fungi is depending upon the dose, which is a necessary supposition for the possibility of influencing the growth rate by relatively low doses. However, we also found a positive, i. e. growth-promoting effect. This is in agreement with earlier experiments concerning low-dose radiation effects on fungi.

The experiments are continued, as they are of practical importance for the therapy of dry rot and the radiation effects at low doses.

Ergebnisse des Projekts Nr. 3

Leiter des Projekts und wissenschaftliche Mitarbeiter:

Dipl. Phys. C. Bunnenberg

Titel des Projekts:

Studies on the evaporation and condensation of water vapor in soils.

During the report period 1973 the equipment built in the year before was completed by a program-controlled temperature regulation providing an automatic simulation of the temperature inversions in atmosphere and soil in a day-night cycle measured in the Negev Desert in Israel.

The radial heat transport in the soil column was minimized by careful insulation of the heat conducting steel container aspiring "infinite geometry" of the soil column.

Experiments with this set-up and Negev loess soil yielded results concerning depth and speed of penetration of water vapor originating from the atmosphere under the condition of daily temperature inversions. The atmospheric vapor was labelled with tritium for 2 days while collecting it in tubes at different depths of the soil column and determining the tritium content.

At a depth of 40 cm below surface activity was not detected until 13 days after labelling. After 27 days the tritium content above 16 cm below surface had gone down considerably, while it was still increasing in deeper soil layers.

Pure diffusion was not taken into account. The results of those experiments were reported on at an IAEA-symposium in Vienna, October 73.

During a visit to Israel in September 73, the experimental results and possibilities of corresponding field experiments in the Negev were discussed with members of the Institute of Botany of the Hebrew University, Jerusalem.

Further work is concentrated on the investigation of special parameters governing the vapor movement within soils and between soil and atmosphere. A new soil container is presently drafted to increase the experimental variability of certain parameters and the measuring accuracy.

Ergebnisse des Projekts Nr. 4

Leiter des Projekts und wissenschaftliche Mitarbeiter:

Dipl. Phys. H.P. Schätzler

Titel des Projekts:

Measurement of moisture in thin
loessial soil layers by a capillary
porous probe.

After the application of the equipment for measuring low moisture contents in thin soil layers in the laboratory during an IAEA training course, experiments were carried out in the Negev Desert in cooperation with the Institute of Botany of the Hebrew University, Jerusalem, in September 73.

They have shown that this technique is superior to neutron probes, if high spatial resolving power and sensitivity at low moisture contents (below 9%) is required. On the other hand the porous body probe can only be driven into the soil after rough-drilling, if the soil has not been cultivated for more than a year. Rough-drilling, however, may result in partially insufficient contact between soil and porous body. So, the high sensitivity and accuracy of this measuring technique can only be achieved in fairly soft soils.

Experiments in the Negev also showed that the moisture content of the top dew wettened soil layer is of special importance and interest. The contribution of this dew dependent moisture to the natural irrigation of plants cannot yet be determined. Prof. Evenari suggests to study the influence of this top soil layer in connection with the temperature inversions in the soil-atmosphere system, which includes the continuous measurement of the moisture in the top 2-cm layer. For this purpose the development of a new measuring technique will be started this year.

PUBLICATIONS

KÜHN, W., HANDL, J. :

Zur Erkennbarkeit von Fäulen in stehenden Bäumen durch Röntgen-
diagnose.

Holzforschung 5, 27. Bd (Oktober 1973).

KÜHN, W., SCHÄTZLER, H.P.:

Mass Determination of Plantations by Absorption of Gamma-
Radiation.

Atomkernenergie 21 (1973).

DAMMANN, W., ELMDUST, M., KÜHN, W.:

Kontinuierliche Bestimmung des Wasserdampfes im Boden durch
Tritiummarkierung.

Kerntechnik 7 (1973).

BUNNENBERG, C., KÜHN, W.:

Movement of Water Vapor in Arid Loess Soil Under the Condition
of Temperature Inversions.

Proc.Symp.on Isotopes and Radiation Techniques in Studies of
Soil Physics, Irrigation and Drainage in Relation to Crop Production.
Vienna, 1-5 October 1973. IAEA-SM-176/7, in press.

KÜHN, W., SCHÄTZLER, H.P.:

Moisture Measurement in Thin Soil Layers by Absorption of
Gamma-Rays in a Capillary Porous Body.

Soil-Moisture and Irrigation Studies II, IAEA, Vienna (1973).

Commission's associate: University of Modena
Contract No.: SC/11-I/094-72-1 BIAN
Head of the research group: Ernesto Carafoli
General theme of the contract: Transport of calcium and strontium
in chloroplasts and plant mitochondria

The research has been carried out by Dr. E. Carafoli, Dr. F. Novetti, and M.F. Dalgai, and is still in a rather preliminary stage, due to bureaucratic delays in the beginning of the contract.

Efforts have been concentrated on the fractionation of chloroplasts, and on the isolation from their membrane system of protein fractions capable of binding Calcium and Strontium with high affinity. Mild hypotonic shocks were applied to chloroplasts. The soluble extract obtained was concentrated on diaflo membranes, and fractionated on preparative polyacrylamide gel electrophoresis columns. Under these conditions, it is possible to isolate from animal mitochondria an acidic glycoprotein with high affinity for Calcium; no acidic protein capable of binding calcium was however present in the chloroplasts extracts which have been analyzed so far. The absence of easily-dissociable glycoproteins capable of binding divalent cations from the chloroplast membrane is "per se" of interest. Research is now in progress on chloroplast extracts obtained with exposure to chaotropic agents, which have been shown to extract firmly-bound proteins from other membrane systems. Among them, lithium di-jodo salicylate, which is apparently specific for extracting glycoproteins, appears to be the most interesting.

ZELLKULTUREN

CELL CULTURE

CULTURE DE CELLULES

Commission Associate: Istituto di Genetica della Università, Pisa

Contract Number: 106-72-1 BIOD

Head of research team : Prof. F. D'Amato

Co-workers: Drs. M. Buiatti, A. Bennici, C. Geri, P.G. Cionini,
M. Pagliai.

Subject of the Contract: Cytology and genetics of plant tissues
and cells grown in vitro.

Report on activities 1973

During 1973, the following investigations have been carried out:

1) Cell dedifferentiation in plant tissues grown "in vitro"

Work on the biochemistry of the initial phases of Nicotiana glauca pith tissue dedifferentiation was continued. Data concerning the transient appearance of a DNA satellite (1.722 g/cm^3) were confirmed along with the constant presence of a 1.705 g/cm^3 peak which was tentatively supposed to represent mitochondrial DNA. Moreover, preparative electrophoresis of labelled DNA extracted after different periods of culture showed the presence of three distinct bands with different labelling patterns. In particular, the specific activity of the faster running band increased up to 72 hours and decreased again later on, thus exhibiting a behaviour parallel to that of the forementioned DNA satellite. Preliminary analytical centrifugation data seem to confirm high density values for this band .

Cytological and biochemical analyses were carried out on tumorous and non-tumorous strains of the hybrid Nicotiana glauca x N. langsdorffii. Preliminary data show a prevalence of an amplification - cellularization process over mitosis in the early phases of dedifferentiation of the non-tumorous strain whose DNA, submitted to analytical centrifugation in the presence of Ag^+ , showed two satellite peaks. The tumorous strain, on the other hand, proliferated mainly through mitosis; analytical

centrifugation revealed only the presence of main band DNA (Buiatti, Durante, Geri, Giorgi, Parenti).

2) Molecular biology of the embryo suspensor of Phaseolus coccineus.

Work on the localization of genes in the polytene chromosomes of the embryo suspensor cells of Phaseolus coccineus by molecular DNA-RNA hybridization has been continued. Radioactive 5S RNA was isolated from ribosomes extracted from seedlings of P.coccineus fed with ^3H -uridine. Preliminary information on chromosome regions bearing the cistrons for 5S RNA has been obtained. Further work is now in progress in which use has been made, for in situ hybridization, of 5S RNA with a very high specific activity as obtained by iodination with ^{125}I according to the technique of Prenskey, Steffensen e Hughes 1973, P.N.A.S., 70: 1860-1864).

Experiments have been made to localize autoradiographically in the polytene chromosome cells the synthesis of ribosomal RNAs by means of methylation as obtained by treatment with ^3H -methylmethionine. Since indications have been found on temporal differences in the transcriptional activity of the nucleolus organizing regions (NOR) in the two pairs of NOR-chromosomes, the work is being continued. Some aspects of the binding of ^3H -actinomycin D to DNA in fixed materials have been investigated on the metaphase chromosomes of Vicia faba. (Avanzi, Durante, D'Amato, Cionini).

3) Genetics of growth and differentiation "in vitro" of cauliflower

A series of experiments were carried out to obtain comprehensive data on the genetic control of cauliflower growth (cell proliferation) and organ differentiation in vitro, using six inbred lines.

A diallel test was set up on which two in vitro (callus growth and bud formation) and four in vivo (curd diameter, leaf length and width, days to flowering) characters were analyzed. The

results, besides confirming the existence of a stringent genetic control (mainly additive) on the two in vitro characters, allowed interesting conclusions to be drawn on the genetic control of developmental processes. The presence of two gene blocks was suggested, one influencing callus growth, curd diameter, days to flowering, the other influencing in vitro bud induction, curd diameter, leaf width. Moreover, non-additive effects for leaf length, curd diameter, leaf width were all correlated and found to be determined by the interaction of alleles controlling callus growth and in vitro bud induction (Baroncelli, Bennici, Buiatti).

Publications

- 1) Baroncelli S., Buiatti M., Bennici A. and Santoro A. (1973). Genetics of differentiation in vitro in Brassica oleracea var. botrytis: a preliminary note. Inf. Bot. It., 5, 104.
- 2) Baroncelli S., Buiatti M. and Bennici A. (1973) Genetics of growth and differentiation "in vitro" of Brassica oleracea var. botrytis. I. Differences between 6 inbred lines. Z. Pflanzenzüchtg. 70, 99-107.
- 3) Baroncelli S., Buiatti M., Bennici A. and Pagliari M.. Genetics of growth and differentiation in vitro of Brassica oleracea var. botrytis. III. Genetic correlations and ontogenetic unity. Z. Pflanzenzüchtg. (in the press).
- 4) Bennici A. . Cytological analysis of roots, shoots and plants regenerated from suspension and solid in vitro cultures of haploid Pelargonium. Z. _____ Pflanzenzüchtg. (in the press).
- 5) Bennici A., Baroncelli S., Buiatti M., Pagliari M. and Sassoli O.. Analisi genetica in Brassica oleracea var. botrytis coltivata in vitro. Atti Ass. Genet. It. (in the press).
- 6) Buiatti M., Baroncelli S., Bennici A., Pagliari M. and Tesi R.. Genetics of growth and differentiation in vitro of Brassica oleracea var. botrytis. II. An in vitro and in vivo analysis

of a diallel cross. Z. Pflanzenzüchtg. (in the press).

- 7) Buiatti M., Durante M., Giorgi L., Martini G., Nuti Tonchi V., Parenti R., Grisvard J. and Guillé E.. Dati citologici e biochimici preliminari su colture di tessuto dell'ibrido tumorale Nicotiana glauca x N. langsdorffii e un suo mutante non tumorale. Atti Ass. Genet. It. (in the press).
- 8) Cionini P.G.. Differential binding of tritiated actinomycin D as compared to other banding patterns in Vicia faba metaphase chromosomes. Caryologia (in the press).
- 9) Durante M., Giorgi L., Parenti R., Buiatti M., Guillé E. and Grisvard J.. Comparsa di un DNA satellite durante la sdifferenziazione di midollo di Nicotiana glauca. Atti Ass. Genet. It. (in the press).
- 10) Parenti R., Guillé E., Grisvard J., Durante M., Giorgi L. and Buiatti M. (1973). Transient DNA satellite in dedifferentiating pith tissue. Nature New Biol. 246, 237-238.

Vertragspartner der Kommission: Prof. Dr. J. Reinert
Inst. f. Pflanzenphys.
u. Zellbiologie
1 Berlin 33
Königin-Luise-Str. 12-16a

Nr. des Vertrages: 117-72-1 BIO D

Leiter der Forschungsgruppe: Prof. Dr. J. Reinert

Allgemeines Thema des Vertrages: "Growth and differentia-
tion of cells and plant
tissues growing in vitro."

The investigations in 1973 were directed to 3 main aims.

- 1 A) Control and enhancement of embryo formation in anthers and cell cultures of *Nicotiana tabacum* (Var. White Burley) by exogenous factors,
- B) Production and selection of haploid cell cultures, which are genetically stable at least over short periods (4-8 weeks),
- 2) Isolation, cultivation and fusion of protoplasts from different cells and tissues of higher plants.

Ergebnisse des Projekts Nr. 1

Leiter des Projekts und wissenschaftliche Mitarbeiter.

Prof. Dr. J. Reinert; Prof. Dr. H.J. Köster;
G. Gosch; E. Heberle.

Titel des Projekts:

"Production of haploid embryos from anthers and cell
cultures growing in vitro."

A) The work on the influence of exogenous factors on the percentage of embryo forming, isolated anthers of *Nicotiana tabacum* (Var. White Burley) was extended. Experiments with different nutrient media proved that the medium according to Mitsch (1969) with an average of ca. 40% of embryo forming anthers was superior to several others including the Linsmaier- and the Murashige-Skoog as well as White's medium.

The addition of a cytokinin in concentrations around 1 μ /ml had an inhibiting effect on the production of embryos by the tobacco anthers (26%) and it caused regularly the formation of callus tissue by 30-40% of the isolated anthers. These callus tissues formed regularly shoots after cultivation periods of more than 5 weeks. In experiments on the possible enhancement of androgenesis by extracts from embryogenic anthers we could show that besides enhancing substances they contain also inhibitors of embryogenesis. The removal of embryo-forming anthers after a cultivation-time of 2-4 weeks on agar media and its replacement by freshly isolated objects resulted in a considerably lower percentage of embryo formation (7%) as that of the controls (45.3%). The inhibiting factor secreted by the anthers stopped growth and caused browning of freshly isolated anthers after 5 - 10 days. This or these inhibitors must be separated before extracts from embryogenic anthers can be used for enhanced embryo formation.

B) One of the main difficulties in investigations on the genetical stability of pollen, other cell cultures and on DNA levels in cultures and protoplasts (see 2) is the lack of a reliable staining method for quantitative measurements. In tests with different fixation and staining techniques it turned out that successful Feulgen staining of nuclei of cells from suspension cultures is regularly possible, if formic acid is used for the fixation and temperature as well as time for hydrolysis and staining are exactly standardised. However, this did not pertain to Feulgen staining of pollen. In this case the generative nucleus could be regularly stained by the improved Feulgen method, but the vegetative nucleus behaved differently. In freshly isolated pollen the vegetative nuclei could only be stained by an additional treatment with orcein or carmine-acetic acid, while some days after the isolation the Feulgen reaction was sufficient for reliable staining. This difference depends obviously on the stage of pollen development and is caused by a different condition of the DNA respectively the chromatin.

Projekt Nr. 2

Recently we have shown that suspensions of carrot cells provide large numbers of protoplasts after selective enzymatic destruction of the cell walls. We could observe mitosis, but no wall formation and cell division in this material. In order to clarify this situation and to induce cell division, our efforts were concentrated on 3 aims.

Firstly, improved starting material, i.e. cells with a high content of protoplasm and with thin cell walls. Both could be induced by shortening the transfer period from 4 weeks to a few days.

Secondly, better purification of the isolated protoplasts from debris and dead cells after enzymatic destruction of the cell walls. This was accomplished by a combination of special filtration with a 2-step gradient centrifugation.

Thirdly, better growth of the protoplasts. In this case tests with several carbohydrates and vitamins led to the addition of meso-inositol, xylose and arabinose to the basic nutrient medium resulting in significantly better growth of the protoplasts. On the basis of these results we have started now experiments on cell wall formation and fusion of the protoplasts from carrot cells.

Publications

Meyer-Teuter, H. and Reinert J.: "Correlation between rate of cell division and loss of embryogenesis in long term tissue cultures."

Protoplasma 78, 273-283 (73)

Reinert, J.: "Aspects of organization - organogenesis and embryogenesis." in "Plant Tissue and Cell Cultures" edited by H.E. Street; Blackwell Scientific Publications Ltd., Oxford, 1973

Reinert, J. and Hellmann, S.: "Aspects of nuclear division and cell wall formation in protoplasts of different origin."

Colloques internationaux du C.N.R.S.

"Protoplastes et Fusion de Cellules Somatiques Végétales" No. 212, pp. 273-280, Paris 1973

Reinert, J.; Gregor, D. and Matsumoto, H.:

"Studies on the chromatin of carrot cell cultures growing in the presence and absence of auxin."

Abstracts/The 8th Intern. Conference on Plant Growth Substances, Tokyo, 1973, pp. 138

Associato della Commissione: Comitato Nazionale
per l'Energia Nucleare, Lab. Agricoltura
N° del contratto : Euratom-Cnen 107-72-1 B101

Capo del grupo di ricerca: Prof.A.Bozzini

Tema generale del contratto: Applications of the
in vitro cultures to radiobiological researches
and mutagenesis of higher plants

The researches carried out in 1973 were
principally oriented in three directions:

1) The use of in vitro culture techniques
in relation to self-incompatibility problems.

2) The research at the macromolecular level
of the modifications induced by in vitro culture in
different plant tissues.

3) Genetical studies on isogenic lines of
tobacco derived from anther cultures and mutagenic
treatments of the microspores from a diploid iso-
genic line.

Risultati del progetto n. 1

Capo del progetto e collaboratori scientifici:

M.Devreux, D. de Nettancourt, U.Laneri, P.De Martinis.

Titolo del progetto: The use of in vitro culture techniques in relation to self-incompatibility problems.

1.1. Anther cultures of Lycopersicum peruvianum and L.esculentum were performed during all this year in order to try the induction of haploid plants from these materials . We are carrying out this research according to the methodology published last year by Greeshof and Doy in Australia (Planta, 1972) and we have obtained till now in greenhouse more or less 45 plants by this technique.

This method is based on the obtention of a callus from the anther culture, the proliferation of this callus on a second medium and, in a third step, on the regeneration of plantlets from the callus formed; the probability to obtain haploid plants remains conditioned by the haploidy of the callus and we know that the callus of tomato in vitro culture does not maintain a good cytological stability. In fact, the first plants regenerated from these calli obtained by anther cultures, were till now diploid and tetraploid.

We must now test the origin of these diploids and tetraploids. We start from the incompatible L.peruvianum, therefore, if the tetraploids come from the microspores, the allelic situation at the S-locus would be 4 times S_1 or 4 times S_2 and the plant will not be self-fertile; at

the contrary, if the tetraploid plants come from the diploid tissue of the anther wall, the allelic situation will be $S_1S_1S_2S_2$ and the plant will be self-fertile. So it is very easy to detect the origin of the regenerated tetraploid plants. At the diploid level, we can test the origin by crosses with the mother plant because one of the reciprocal crosses will be fertile only in the case of a isogenic plant. We have till now tested the self-fertility of several tetraploids and all these plants show fruit formation.

As to the possibility to obtain haploid plants of Lycopersicum, Debergh and Nitsch presented this year interesting results carried out with L.esculentum anthers using a new culture medium including an extract of embryogenic anthers of Datura or Nicotiana. This new way is based on the possibility to extract from anthers of these species cultivated in vitro and taken at the embryoid stage, an active substance which could induce the microspores of tomato to differentiate into embryoids during the anther culture, avoiding the passage through a callus formation. We are following now this new technique using the tobacco anthers to prepare the extract for the L.peruvianum anther cultures.

1.2. Last year, we referred about some hybrids between L.esculentum and L.peruvianum saved by in vitro embryo culture. This year, we are pursuing anther cultures from these hybrids and we obtained till now good callus formation with this material. Our aim is to try to regenerate haploids from these Lycopersicum hybrids in order to include in the esculentum genome several

interesting characters of the peruvianum species, and particularly: the self-incompatibility, for hybrid seed production; the uniformity in flowering time, for mechanical ripening; and some disease resistances (*Verticillium*, *Fusarium*, etc.). If we can induce haploid plants from these hybrids, it is clear that each plant will be a new genic recombination between the two species and the isogenic diploid plants will be perfectly fertile.

1.3. The in vitro culture of tissue coming from different parts of self-incompatible plants are pursued in order to constitute a "bank of tissues" characterized by known S-alleles. We are maintaining a callus coming from a petal of Nicotiana alata since more than one year and half; from anther cultures of L.peruvianum, we maintain tissues of five genotypes: S_1S_3 , S_1S_5 , S_2S_3 , S_6S_7 , and the tetraploid $S_1S_1S_5S_5$; from style culture, we have the genotype S_1S_4 .

1.4. In order to finding out if in vitro culture can also induce mutations at the S-locus or elsewhere on other genes, we have regenerated, from in vitro culture of stem disks, plants of L.peruvianum of different genotypes:

1 plant from the genotype S_1S_4

1 plant from the genotype S_2S_4

9 plants from the genotype S_1S_5

12 plants from the genotype S_4S_5

18 plants from the genotype S_2S_3

Many of them are tetraploid and tested for the self-fertility; the others, diploids, must be crossed with the mother plants.

1.5. With regard to the biological screening method for mutated pollen at the S-locus, the in vitro culture

of N.alata style with compatible and incompatible pollens was improved while all the attempts to realize the same test with L.peruvianum style gave negative result.

1.6. After self-pollination of the hybrids L.es-culentum x L.peruvianum or after reciprocal crossing between the hybrid and the parental species, the analysis of the pollen tube growth by means of fluorescence techniques allowed a distinction between pollen tubes inhibited by an unilateral incompatibility reaction and pollen tubes inhibited by a self-incompatibility reaction. This observation was confirmed by the electron microscopy analysis (see the report by the "incompatibility group" of the Euratom-Ital Association).

Risultati del progetto n. 2

Capo del progetto e collaboratori scientifici:

A.Brunori, M.Devreux.

Titolo del progetto: The research at the macromolecular level of the modifications induced by in vitro culture in different plant tissues.

2.1. During the 1973, Dr.A.Brunori have completed his fellowship in the laboratory of Dr. Stern at La Jolla University in California. He performed experiments on the DNA analysis based on the use of CsCl gradients and hydroxyl hypatite fractionation.

2.2 We are now carrying out an analysis on DNA synthesis of Nicotiana tabacum pith tissue which takes place following the beginning of the in vitro culture by means of the CsCl gradient technique in order to observe if some particular fractions of DNA underwent preferential synthesis. So far, most of the efforts have been devoted to the working out a suitable technique for DNA isolation from pith and callus cells. The isolation of DNA from such cells is a very difficult task, it requires the isolation of the nuclei which can be accomplished by grinding the cells in ethyl alcohol or with a medium containing sucrose. We are facing another difficulty due to the tremendous amount of starch present in the pith cells at the time of the explant, which tends to trap much of the DNA.

2.3. To avoid the difficulties in the microphotometric measurements with cells of differentiated tissue like pith or with provascular cells which make very difficult the preparation of suitable squashes for the DNA lectures, we

worked out a method for nuclei isolation from fixed tissue using enzymatic digestion of the cell wall. The naked cells are broken passing the cell suspension through a syringe. The freed nuclei pass through a miracloth and are collected by a low speed centrifugation; further they are purified suspending them in 45% acetic acid.

The nuclei suspension is used to prepare the smears which can be processed for any staining reaction.

Risultati del progetto n. 3

Capo del progetto e collaboratori scientifici:

M.Devreux, D. de Nettancourt, U.Laneri, P.Chuffart.

Titolo del progetto: Genetical studies on isogenic lines of tobacco derived from anther cultures and mutagenic treatments of the microspores from a diploid isogenic line.

3.1. In the research field on a better understanding of the mechanism of the tobacco anther culture, we are trying to obtain a methodology giving: 1) a maximum number of haploid plantlets from embryogenic anther and 2) a maximum yield of embryogenic anthers.

1) From previous experiments, it appeared that when only one plantlet comes out of one of the 5 anthers in a culture tube, no other plantlets are obtained in the same tube, whereas a large quantity of embryoids were present in the anthers. Also in the case in which several plantlets were induced from the five anthers of a flower bud in the same culture tube, it was clear that many embryoids did not develop and remained blocked at different developmental stages. We thought that the inhibition of many embryoids in the culture tubes bearing haploid plantlets could be due to some change in the auxin equilibrium following the development of the first plantlets. In order to overcome this limitation, we performed this year an experiment, repeated 11 times, with 50 anthers ($\pm 2.10^6$ microspores) in a shaken liquid culture medium and we observed that, in this conditions, all the repetitions gave us haploid plantlets in very large quantity without

inhibition (till \pm 7000 embryoids from 5 flower buds).

This result could be explained by three hypotheses:

- a) the oxygen conditions are quite better in this culture
- b) the embryoids are rapidly detached from the anther wall
- c) the possible inhibitor induced by the first plantlet are diluted in the liquid medium.

2) As regard the increase of the embryogenic anthers among the flower buds used in each experiment, we are trying to reach this purpose giving, before the beginning of the culture, different types of treatment in order to synchronise the microspores in the different anthers. The results are so far not enough reliable.

3.2. We have carried out anther cultures of some other cultivated species: with Triticum durum, using the method giving good results on barley in the laboratory of Clapham, the results are completely negative. On Rice, working with Italian varieties and using the method recommended by Nii-zeki and Oono, we have obtained some plantlets and transferred the results to the Rice Breeding Station of Vercelli. On Strawberry, in collaboration with the Fruit Trees Agricultural Station in Rome, we are obtaining good callus formation and we have regenerated till now 15 plantlets; the first six plants, controlled as chromosome number, are diploid; we must now ascertain the origin of these plants.

3.3. We have also, this year, begun an active research on protoplast fusion in vitro. The technique of selective cell wall elimination by enzymatic treatments and the microscopic observation of protoplast fusion were reached. We are trying to regenerate callus and plantlets from the protoplasts. The material used are three species of Nicotiana and Vicia faba.

3.4. Attempts are under way to induce mutations in the microspores from a real diploid species. X-rays treatments are carried out on the flower buds of Nicotiana sylvestris before the dissection of the anthers in order to irradiate free single cells. Chlorophyll mutations will be identified in the culture tubes. We intend to decrease the X-rays exposures till the lowest dose giving genetic effects.

PUBLICATIONS

- U.LANERI and D.de NETTANCOURT - Distinction between complete compatibility and semi-compatibility by means of fluorescence technique. Incompatibility Newsletter, 2: 56-59, 1973.
- U.LANERI - The extent of self-pollination in emasculated and non-emasculated flowers of Lycopersicum peruvianum. Incompatibility Newsletter, 2: 67-69, 1973.
- M.DEVREUX and U.LANERI - Anther cultures of Lycopersicum peruvianum. Incompatibility Newsletter, 3: 12, 1973.
- M.DEVREUX and U.LANERI - Diploids and tetraploids of Lycopersicum peruvianum regenerated in vitro from internode fragments of diploid plants. Incompatibility Newsletter, 3: 13, 1973.
- D. de NETTANCOURT, M.DEVREUX, A.BOZZINI, M.CRESTI, E. PACINI and G.SARFATTI - Ultrastructural aspects of the self-incompatibility mechanism in Lycopersicum peruvianum. J.Cell Sci., 12: 403-419, 1973.
- D. de NETTANCOURT, M.DEVREUX, U.LANERI, E.PACINI, M. CRESTI and G.SARFATTI - Ultrastructural aspects of unilateral interspecific incompatibility between Lycopersicum peruvianum and L.esculentum. Caryologia, 25, suppl.: 207-217, 1973.
- D. de NETTANCOURT, M.DEVREUX, U.LANERI, M.CRESTI, E. PACINI and G.SARFATTI - Genetical and ultrastructural aspects of self and cross incompatibility in interspecific hybrids between compatible Lycopersicum esculentum and self incompatible L.peruvianum. Theor. Appl. Gen. (in press).

Vertragspartner der Kommission:

Gesellschaft für Strahlen- und Umweltforschung mbH, München

Nummer des Vertrages: 118-72-1 BIO D

Leiter der Forschungsgruppe:

Prof. Dr. H. Gaul, Leiter der Abteilung Pflanzengenetik

Allgemeines Thema des Vertrages:

Cell-culture genetics in barley, wheat, potato and maize.

For practical plant breeding the production of haploid plants from anthers, as compared to cross breeding, has the following advantages: Mutants can be detected in the M_1 -generation; the F_1 -hybrids are homozygote immediately after diploidization; new varieties can be obtained in considerably shorter time.

Experiments with barley anthers were carried out with the primary intention of inducing callus growth. The resulting calluses should then be regenerated into whole plants. The experimental series conducted so far varied in their culture conditions, i.e. temperature, light, and composition of the culture medium.

Ergebnisse des Projekts Nr. 1

Leiter des Projekts und wissenschaftliche Mitarbeiter:

Prof. Dr. H. Gaul
Dr. B. Foroughi-Wehr

Titel des Projekts:

Development of techniques for the production of haploid plants through the use of anther culture.

Darstellung der Ergebnisse:

The greatest part of the experiments described in the following have only been started a few weeks ago, and consequently, are not yet completed. (The reasons for this delay are outlined in the attachment.) Hitherto the experiments were carried out exclusively on barley anthers. Varieties used are: Mutina, Edelmut.

The culture medium of MURASHIGE and SKOOG was used with the following modifications:

No.	No. of anthers	Variation in the growth regulators	Culture conditions (Light/Temperature)
1	150	2,4D	Permanent darkness (PD)/28°C
2	350	gibberelin (GA ₃)	PD/20°C 16 hrs light, 8 hrs dark/20°C
3	200	IAA	PD/12 hrs, 10°C; 12 hrs, 25°C
4	900	kinetin kinetin + 2,4-D	PD/20°C
5	1200	gibberelin, 2,4-D IAA	PD/20°C

Pollen grains of all the development stages were cultivated, starting from the pollen mother cell up to the pollen at three nucleate stage.

In experiment No. 1, one anther has formed callus. In experiment No. 2, callus developed, in the light as well as in the dark, with nine anthers, i.e. 2.8%. The callus developed in the light contained chlorophyll, the one growing in the dark was of a light yellow colour.

Results of further experiments are not yet available. Some of the Calluses thus obtained were divided, in order to be grown subsequently on a medium minus 2,4-D, but plus kinetin. No organogenesis has yet occurred.

The anther culture method as described above should be extended to include experiments with potato, maize and wheat.

Attachement

June 1973: The tissue culture laboratory was moved from Köln-Weiden to Grünbach, near Munich.

1 July 1973: Dr. G. Corduan resigned.

Dr. B. Foroughi-Wehr joined the programme as co-worker for the field of tissue culture genetics.

Until September 1973: The tissue culture laboratory was being equipped.

Until December 1973: The premises to be used for the cultivation of callus cultures were set in operation.

Presumably at the beginning of 1974: Completion of two growth chambers.

RADIOENTOMOLOGIE

RADIOENTOMOLOGY

RADIOENTOMOLOGIE

Contract partner of the
Commission:

Free State of Bavaria, represented
by the Bavarian State Institute
for Soil and Plant Cultivation
München-Freising, Federal Republic
of Germany

Contract Number:

114-72-1 BJO D

Head of the research project:

Dr. A. Haisch

General subject of the Contract:

Ecology, rearing and sterilization
of the European Cherry fruit fly
(Rhagoletis cerasi L.)

The sterilization of insects is a genetic procedure of pest insect control. Its feasibility for a practical large scale application was already shown in the USA. Aim of this research project is to clarify whether this technique can reach a practical importance under the circumstances prevailing in Germany. The European Cherry fruit fly was chosen as test object because its biology as far as it was known offered a certain chance of success. The Cherry fly can be controlled by insecticides. However, the time between the date of application and consumption of the fruit lasting only three weeks is very short, which means that the danger of toxic residues on the fruit is relatively high. Therefore, a substitution of the insecticides by a biological technique is desirable.

The control of the Cherry fly by sterilization involves the large scale multiplication and sterilization of the pest insect. These sterile insects are released to mix with the flies existing in the field. This way they are able to transfer genetic damages by mating on the field population. The genetic damages caused weaken the multiplication capacity of the field population.

Project No.1: Small and large scale rearing

The main problem of the small and large scale rearing is still in an unchanged way the difficulty of nutrition and the raising of larvae. One of the numerous tested feeding substrates showed relatively good rearing results. Its nutritive components have been yeast, sugar, a vitamin mixture and wheat germs. The microbial decomposition of the

substrate was prevented by 0,4 % propionic acid at a pH of 4,0 - 4,2. As texture forming agent agar-agar (5 %) was used. The development of the larvae on this substrate was finished at the short time of 9 - 14 days and 46 % of the larvae used reached pupation.

This favourable result caused us to find a simplification and rationalization of the time consuming working technique. The concerning measurements referred to the care of the eggs collected and to the neonate larvae as well as to the preparation of the feeding substrate. The original input of work could be reduced by the half by the simplification. But the rearing results did not meet the expectations. The development of the larvae was doubled. Therefore heavy infection by fungi occurred, so that the pupation rate dropped to 10 %. The analysis of this statement is not yet finished. The negative result may be probably caused by an increased infection of the eggs and neonate larvae by microorganisms.

Other experiments pertaining to the physiology of nutrition showed that the used Torula yeast is not useful. It is indeed cheap but the rate of mortality increased from about 20 % to 50 % up to 90 % after being fed. Brewers yeast did not show this detrimental effect.

The analyses of the nutritional values of the different nutritive compounds were continued. As already mentioned in the previous report of 1972 the pupation rate is increased by adding wheat germs. Without any wheat germs no larvae developed. However, with the increased content of wheat germs also the mortality rate of the pupae was raised logarithmically. A six times fractionated extraction of the wheat germs by solvent with increasing polarity should solve stepwise the nutrients and toxins out of the wheat germs. The concerning extracts and residues as well as both together have been tested in an adequate concentration. Surprisingly, none of the extracts allowed any development of larvae. Also, residues and residues plus extract did not prove to be effective in a different way. The pupation rates of the first four fractions have been equal and not before 50 % of the total dry substance of the wheat germs have been extracted the yield of pupae dropped. From the aspect of the physiology of nutrition the value of wheat germs may be small. Its observed positive effect in the feeding substrate could be the result of its structure improvement.

Project No.2: Ecology and Sterilization

Releasing of sterile insects

In 1973 the first experiment of releasing sterile insects was undertaken in order to answer methodological questions. The preconditions have been favourable because a late frost had killed the cherry blossoms at low and mean sites of the cultivations. Therefore the lack of any fruit let expect only very small populations of the Cherry fly. Three small sites partly surrounded by wood were disposable for the experiment. Due to their location the sites have been considered to be largely isolated. A change of their habitats seemed to be not likely according to experience previously won. At the smallest site 4970 sterile and yellow labelled flies have been released. At the 2nd site pupae had been dug in the early spring so that 4720 fertile flies could emerge, whereby they were marked red. The 3rd one was a control site.

The infestation was 39 % in the case of released flies, 18 % if sterile flies had been used, and 2,5 % in the control area. The analysis of recapture data showed that the sizes of the experimental areas were too small and that migration of the flies must have been high. In particular the released adult flies may have had a "long range" flight tendency compared with the flies emerged in the field.

The consequence of the experiment is that the demotops of the Cherry fly are or at least can be larger than it was expected. This circumstance makes the genetic control of the species more difficult.

Studies of population genetics

The necessity to collect flies and pupae in the field at different places arises the question if this material is homogenous or if the flies belong to populations with different features. First results showed considerable differences between some populations. For instance a reduced viability of certain crossings could be observed. Also a different flying behaviour was stated. Individuals from a cooler habitat flew more active at 20° C than such from a warmer area. But at 27° C no difference was stated any more.

Associato alla Commissione: Istituto di Entomologia agraria della Università di Padova.

N° del contratto: 105-72-1 BIOI I

Capo del gruppo di ricerca: Prof. Sergio Zangheri

Tema generale del contratto: Ricerche sulle metodologie e le tecniche per l'allevamento in laboratorio del Dacus oleae Gmel. e di altri insetti di interesse agrario in vista della produzione in massa e ricerche radioentomologiche e biologiche, con particolare riguardo ai ditteri tripetidi.

General Theme of the contract: Researches on methods and techniques for laboratory rearing of Dacus oleae Gmel. and other insects of agricultural interest for mass-production and radioentomologic and biologic researches with particular regard to fruit flies.

A brief outline of the work carried out in 1973

In the ambit of Project No. 1 various species of Trypetidae have been examined proving that the presence of the cephalic organ is a characteristic of the entire family and not only, as was believed, of the Dacus oleae.

In the sub-families, Dacinae and Trypetinae the pharyngeal vesicole is the seat of multiplication of the intestinal symbiotic bacteria, in the sub-family Tephritinae, on the other hand, there are sometimes no symbiont microorganisms present. Important differences have emerged on the mode of transmission of symbionts to the progeny, even in species systemically close, which are reflected in a different sensitivity to disinfectant products and thus on the possibility of preservation of the symbiosis in the rearing on artificial media necessarily containing mould inhibitors.

Thus among the species of economic importance the Dacus oleae Gmelin and the Rhagoletis cerasi L. lose the symbiotic bacteria, while the Ceratitis capitata Wied retains the symbiosis unchanged even

after hundreds of consecutive generations on artificial media and is reared with facility while notable difficulties are encountered in the production of the first species. This demonstrates finally the validity of the studies undertaken on the symbiosis of the D. oleae to the end of overcoming rearing difficulties.

At the same time the researches of Project No. 2 have been proceeding in connection with the rearing problems of insects, concentrating in particular on the use of chemical substances stimulating egg-laying with the scope of increasing the fertility of D. oleae rearings.

In fact, a strong egg-laying stimulating action has been singled out in certain fractions of purification of oleoeuropine, the bitter glucoside characteristic of the olive.

Sprinkling suitable egg-laying sites with the fractions shown to be most active, it has already been possible to double the production of eggs. Researches are in course to single out the stimulating substance which is reasonably held to be a product of the spontaneous degradation of oleoeuropine.

A paper on the subject will be presented to the "Sterility Principle in Insect Control" Symposium (Innsbruck, 22-26 July, 1974).

The bio-ecological studies on Dacus oleae Gmelin relative to Project No. 3, have been carried out, extending in the laboratory the investigation into the influence exercised by meteorological factors, not only on adults, but also on the immature stages.

Thus a series of parameters of valuation have been outlined on the complex inter-action of the climate on the biological cycle and on the fluctuation of the population of D. oleae.

The country investigations have been extended over a large territory on the west shore of Lake Garda whose Dacus populations are isolated by geographic barriers, in the interior of which the production of olives can be surveyed on the basis of the data provided by the oil mills combine.

This has permitted the calculation, on the basis of suitable checkings, of the entity of the D. oleae population in the summer-winter

period.

The enquiry also constitutes a basis for spring surveys with the intention of arriving at a valuation of the Dacus populations throughout the entire year, an indispensable premise for the correct application of modern methods of genetic control.

The researches end in a series of investigations (Project No. 4) concerning the radio-sensitivity of Dacus oleae for which have been calculated the doses of lethal and sterilizing radiation of the various stages of development.

It has, therefore, been possible to single out in the pupae and in adults, the stages which preserve a greater vitality when irradiated with doses necessary for total sterilization; interesting prospects have also emerged from the use of substerilizing doses.

The experiment of admitting sterile insects into the field in the ratio of 8 : 1 : 1 furthermore furnished satisfactory results.

The researches on the radio-sensitivity of the Opius concolor Szépl. (Hymenoptera. Braconidae) and of the Gonocerus acuteangulatus Goeze (Rhynchota Coreidae) have also been brought to completion, the former interesting also for the parthenogenetic reproduction and the second for the elevated radio-sensitivity. This latter is incapable of mating if irradiated with doses sufficient to sterilize it, but interesting prospects have been opened up by the results shown by sub-sterilizing exposure highly efficacious in the first generation.

Investigations are being carried out on the biological effects of irradiation by means of neutrons.

Interesting innovations in the rearing of adults and larvae of D. oleae have been produced in the execution of Project No. 5 and it has been demonstrated that the use of sub-sterilizing doses is more promising in the control of C. capitata with respect to the liberation of completely sterile males.

Country researches have been started, on the basis of the experience gained on Lake Garda, in an area of the Ligurian riviera where the D. oleae constitutes an economic problem because of the high level of infestation reached every year. Thus it will be possible to have a wider vision of the behaviour of the species in areas climatically different.

Risultati del progetto n. 1

Capo del progetto e collaboratori scientifici: Prof. S. Zangheri, Prof. L. Masutti, Dott. V. Girolami.

Titolo del progetto: Influenza dei batteri simbiotici sul ciclo vitale del Dacus oleae Gmel.

The influence of symbiont bacteria on life cycle of Dacus oleae Gmel.

(Researches made in 1973)

Given the complexity of the symbiotic aspects observed in Dacus oleae Gmelin, for a fuller understanding of the phenomenon, the morpho-histological investigation into the organs affected by the symbiosis has been extended to the entire family of the Tephritidae. It has been proved that the cephalic organ is not exclusive to the D. oleae, but constitutes a characteristic of the entire family.

In the sub-families Dacinae and Trypetinae the symbiotic bacteria multiply, as in the D. oleae, inside such a pharyngeal diverticulum, while this does not always happen in the Tephritinae.

Together with the microorganisms of the vesicle membraneous formations come out which originated in the pharyngeal vesicle itself, around which multiply bacteria which become reunited in small masses in the midgut.

Researches are being carried out to ascertain whether such membraneous structures constitute a medium for the development of symbionts.

It has further been shown that the cycle of hereditary transmission of symbionts is more complex than hitherto known, decidedly different even in species systematically near.

This involves a different sensitivity to disinfecting products which is reflected on the possibility of preservation of the symbiosis in rearing on artificial sites, where the use of mould inhibitors substances is indispensable.

Thus C. capitata maintains unchanged the bacterial symbiosis that, on the other hand, is lost in the Dacus oleae, in the Rhagoletis cerasi and in the Rhagoletis pomonella.

The ease of rearing the first and the difficulties encountered in the species which lose the symbionts, beyond the already demonstrated pathogenicity of the bacteria which substitute the symbionts, cannot thus finally be considered independent of the bacterial symbiosis.

This demonstrates again the validity of the studies carried out on the bacterial symbiosis of the D. oleae to the end of solving the age-old problems of the rearing of the insect.

In course of printing on this subject:

Girolami V. - Morpho-histological reports on the bacterial-symbiosis of the Dacus oleae Gmelin and of other Trypetidae in nature and on artificial media.- Redia, Firenze.

Risultati del progetto n. 2

Capo del progetto e collaboratori scientifici: Prof. S. Zangheri, Prof. L. Masutti, Dott. V. Girolami, Dott. ssa L. Panizza, Dott. ssa G. Pellizzari.

Titolo del progetto: Ricerche su substrati artificiali per gli stadi larvali del Dacus oleae Gmel. e di lepidotteri defoliatori e sulle tecniche di allevamento.

Researches on artificial media for the larval stages of Dacus oleae Gmel. and of phytophagous Lepidoptera and on rearing techniques.
(Researches made in 1973)

In the rearing of D. oleae the production of eggs, in the absence of suitable egg-laying sites resulted 6 times lower than of the insects in the presence of olives.

In the hypothesis that egg-laying in D. oleae is stimulated in addition to the already known physical factors, by specific chemical substances as well, a series of extracts from olive leaves or drupes were tested, pointing out a marked action in certain fractions obtained in the course of purification of the oleoeuropine, the bitter glucoside characteristic of the olive. The researches have, therefore, been directed towards the singling out of the stimulating chemical principle, using at the same time the most active fractions with the intention of increasing the yield of the rearings of the D. oleae.

Impregnating small paper domes, suitably moulded, it has thus been possible to double the number of eggs laid (Tab. 1) and furthermore they can be collected through the base of the cage by the traditional method.

It seems reasonable that the active principle is a product of spontaneous degradation of oleoeuropine, since egg-laying is also stimulated, apart from the purified oleoeuropine, by the products of washing the same in a watery solution with chloroform and in particular by the enzymatic aglucone. The already known products of glucoside cleavage were, on

the other hand, shown to be inactive.

In addition to the application in the rearing of D.oleae, the above-mentioned researches might also lead to the singling out of an efficient attraction for the species.

The first results of the researches will be presented in the following article:

Girolami V., Ragazzi E., Pellizzari G. - Prospects of increase in egg production in the rearing of Dacus oleae Gmelin by the use of chemical stimuli.

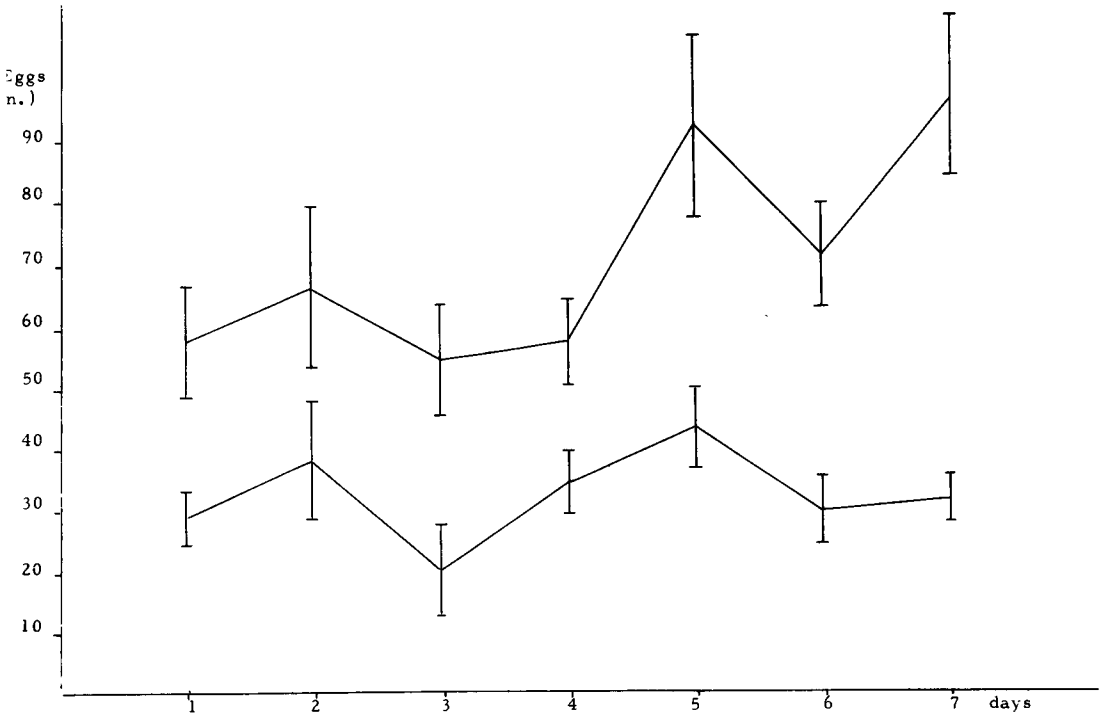

Tab. 1 Average daily laying of groups of 10 ♀ without egg-laying sites (at base) and with small paper domes impregnated with oleoeuropine (average values of 3 replications \pm E. s.)

Risultati del progetto n. 3

Capo del progetto e collaboratori scientifici: Prof. S. Zangheri, Prof. L. Masutti, Dott. V. Girolami, Dott. ssa G. Pellizzari.

Titolo del progetto: Ricerche sulle cause di mortalità del Dacus oleae Gmelin e sulla dinamica delle popolazioni in natura ed in laboratorio.

Researches on mortality causes of Dacus oleae Gmelin and on population dynamics in field and in laboratory.

(Researches made in 1973)

The investigation into the influence of meteorological factors and in particular of the temperature on the development and survival of the Dacus oleae Gmelin has also been extended to the immature stages.

It has been observed that below 7°C the adults are not able to move or feed themselves, while to be able to fly and to reproduce they need a temperature higher than 17°C.

Even in the development of the immature stages such temperatures represent a thresholds, thus, below 7°C there is the arrest of embryonic, larval and pupal development, while the duration in days of the various stages presents a more marked lengthening at decreasing values of temperature between 7° and 17°C with respect to the values comprised between 17° and 25°C (Tab. 2). In particular, the duration in days of the pupal stage is seen, for example, on the whole equal to $52,5-1,68.t^{\circ}$ between 17° and 25°C while it is $128-6,16.t^{\circ}$ between 7° and 15°C (where t° is the temperature in centigrade degrees).

From the researches it has further emerged that at temperature values not sufficient for development the survival of the pupae is not protracted beyond 60 days, for which reason, on the basis of surveys of the soil temperature in the Garda area, it is made clear why the pupae present in the ground in winter do not give origin to adults.

Researches in nature have also been carried out on the western

shore of Garda, on the behaviours and dynamics of the D. oleae population. In addition to studies carried out in small olive groves, from which further information is being obtained regarding the influence of climatic factors on the course of the generations, the tests were extended to the entire area of the commune of Gargnano whose Dacus population is isolated by geographic barriers.

On the basis of the observations that the interruption of continuity of arboreal vegetation, constituted for example by a road or a stream, represents a barrier to the movement of the majority of the adults of D. oleae, it has been possible to divide the entire territory into a series of areas of uniform infestation, determined by the characteristics of the soil.

Since it is possible to know the production for single areas (on the basis of data furnished by the Oil mills Combine), the average weight of the olives and the degree of infestation, it is now possible to evaluate the numerical total of insects present at the moment of harvest.

Since, similarly, the fall of olives and the relative quota of attacked drupes that have fallen prematurely have been checked, it is possible also to arrive at the numerical fluctuations of the immature stages for the entire summer - winter period.

On the basis of the new formulations, it is hoped to obtain an exhaustive picture of the numerical entity of all the stages of D. oleae during the whole year to the end of being able to evaluate the most favourable periods and the modes of execution for possible future programs of genetic control of the species.

The following has been published on this subject:

Girolami V., Cavalloro R. - Chromotropic methods for investigations of the population of adult Dacus oleae Gmelin. - Notes and experimental jottings of Agrarian Entomology, XIV: 13-29, 1973.

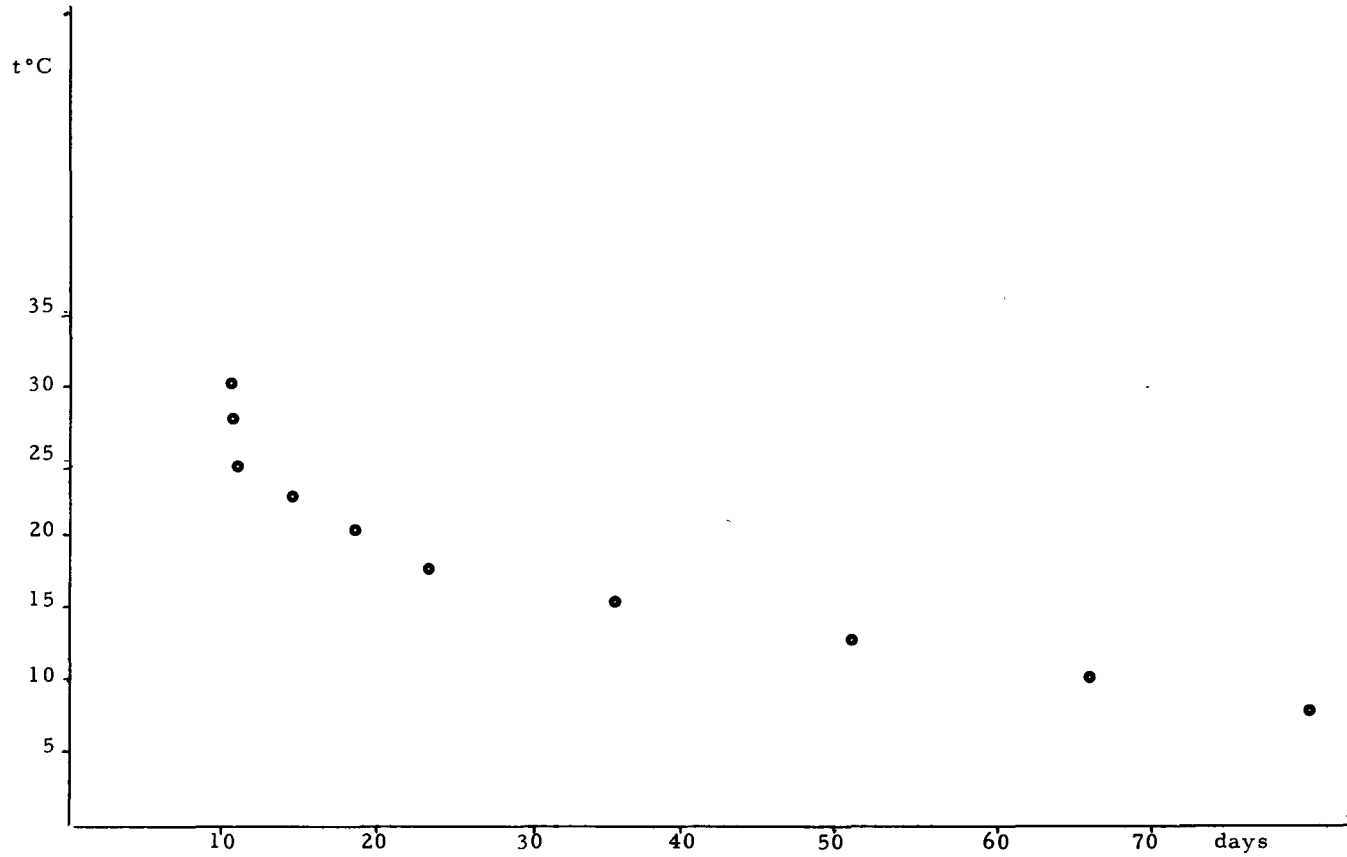

Tab. 2 Duration of the pupal stage of the *Dacus oleae* Gmelin at different temperatures.

Risultati del progetto n. 4

Capo del progetto e collaboratori scientifici: Prof. R. Cavalloro, Dott. G. Delrio.

Titolo del progetto: Effetti biologici comparati delle radiazioni gamma, neutroni e chemosterilizzanti sui diversi stadi di vita degli insetti.

Comparative biological effects of gamma radiations, neutrons and chemosterilants on different life stages of insects.

(Researches made in 1973)

A. Investigations on Dacus oleae Gmel. have been carried on to determine the best sterilizing doses and the influence on the sexual behaviour in sterile males in order to evaluate their competitiveness in comparison with insects of the normal population.

Pupal and adult stages have proved the most suitable to obtain sterile adults without significant secondary effect, because of the remarkable differences between sterility and mortality doses in these two life stages. (Fig.1).

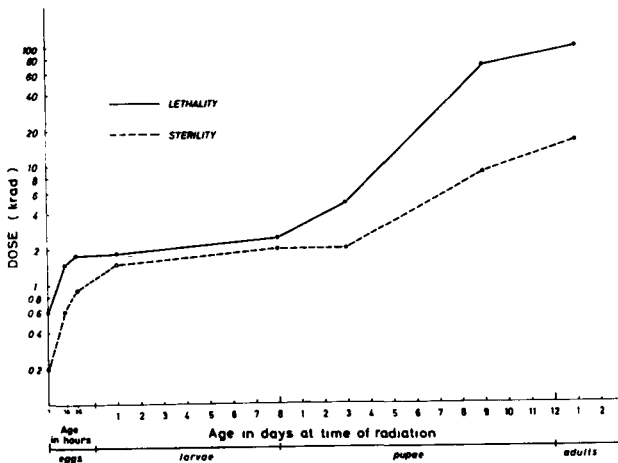

Fig.1 - A comparison between male sterilizing doses and lethal gamma-ray doses for significant developmental stages in the life cycle of Dacus oleae Gmel.

In particular sterilizing doses for males have been identified with 16 krad directly treating neo-emerged adults and with 8 krad irradiating the pupae three days before the emergence of adults. Substerilizing doses have been equally determined for actual use, respectively at 12 and 7 krad.

As to competitiveness (Tab.1) researches have shown that it is advisable to use males taken from irradiated pupae.

Table 1. Mating competitiveness of sterile males versus normal males of Dacus oleae Gmel., evaluated by the fertility of females exposed to different ratio (20 females for each test, at 26 ± 1 °C)

RATIO sterile males to normal pairs	STERILE MALE IRRADIATED			
	at pupal stage (8 krad)		at adult stage (16 krad)	
	EGGS		EGGS	
	laid (No.)	hatch (%)	laid (No.)	hatch (%)
0 : 1	3,486	65.3	2,896	69.8
4 : 1	3,183	40.2	3,084	45.5
6 : 1	3,288	36.6	3,153	40.6
8 : 1	3,529	2.1	3,283	11.1
10 : 1	2,875	1.8	2,731	3.5

In a field test on trees covered with a close-mesh plastic net, the control efficacy by using the technique of the sterile male has been fully confirmed, obtaining, with the ratio of 8:1:1, a infestation of 0,83% in comparison with the 82% in the control.

B. Trials have been started irradiating Ceratitis capitata Wied. and Dacus oleae Gmel. by means of neutrons in each life stage in order to compare their biological effects with those obtained by using gamma-radiations.

Besides, comparison trials are in course with chemosterilants supplied by the Insect Chemosterilant Lab. USDA, Belthsville.

C. Studies on the gamma-radiation sensibility of Opius concolor Szépl. (Hymenoptera, Braconidae).

The insect has been irradiated in all life stages to determine lethal doses, sterilizing doses, the effect on adult life length and other physiological effects.

Full sterilization is achieved on adult males with 10 krad and decreases as doses are lessened (Tab. 2).

Table 2 - Effect of radiation of Opius concolor Szépl. males with different doses on the following generation.

DOSES (krad)	STERILITY (%)
1	18, 35
2	66, 26
4	78, 93
6	89, 79
8	99, 31
10	100, 00

It was found that breeding of irradiated males with normal females decreases the female number obtained in F_1 as doses are increased, while male number remains constant: on the basis of these data, owing to the peculiar pattern of sex determination in this species, sterilization level was evaluated taking into consideration only the obtained female number. Females are slightly more resistant than males to radiations and become sterile with very

little superior doses.

Lower doses are wanted to sterilize the insect in immature stages.

D. Considerable sensibility to gamma-radiations has been found on Gonocerus acuteangulatus Goeze (Rhynchota) adults.

The males of this species no longer mate over an 8 krad dose, at which only 19,3% lethal dominants is obtained. This is why investigations with substerilizing doses (4, 5, 6, 7, 8 krad) have been made on sterility transmission in following generations.

It was observed in this way that, in the F_1 , insects show a higher sterility if compared with the irradiated parental generation.

Table 3. Inherited sterility in Gonocerus acuteangulatus Goeze.

GENERATION	PAIRS STUDIED	CORRECTED AVERAGE % EGG HATCH
$P_1 \text{ ♂ (8 krad) x N ♀}$	9	19.3
$F_1 \text{ ♂ x N ♀}$	6	5.8
$N \text{ ♂ x } F_1 \text{ ♀}$	6	9.8
$F_1 \text{ ♂ x } F_1 \text{ ♀}$	9	4.2

Two papers on this subject are in the press:

CAVALLORO R., DELRIO G. - Radiosterilization of Dacus oleae Gmel. and control possibilities by the use of the sterile male technique. -Redia, Firenze.

CAVALLORO R., DELRIO G. - Mating behaviour and competitiveness of gamma-irradiated Olive Fruit Flies. -Journal of Economic Entomology, Menasha.

Risultati del progetto n. 5

Capo del progetto e collaboratori scientifici: Prof. R. Cavalloro, Dott. G. Delrio.

Titolo del progetto: Studi sul comportamento di femmine e maschi normali e sterili.

Studies on the behaviour of normal and sterile females and males.

(Researches made in 1973)

A. The causes of low fertility in laboratory rearing of Dacus oleae Gmel. have been studied, pointing out in particular the need for the insect to effect the piercing act for the laying of eggs and the necessity for the eggs to stay in the collecting water only for a short time.

Simple and practical improvements have been devised introducing little glass and paraffin balls of proper sizes and colour into the cage bottoms. The females are attracted by such balls and, after trying in vain to pierce them, they drop their eggs which prove more fertile.

In order to prevent eggs from staying too long in water (over 4 hours) a self-working apparatus was designed for collecting eggs periodically.

B. Several pabula for rearing Dacus oleae larvae have been tested, starting from a basic formula (Cavalloro, 1967) and trying to improve its composition.

A large number of diets are being experimented; however it is interesting to stress that propionic acid has proved more efficient among the different antiseptics products used for the control of infestions due to microorganisms.

C. A simple mathematic model has been developed for assessing the efficacy of males with different levels of sterility and distributed in various numerical ratios in the population to be controlled.

The model validity has been checked by means of experimental data concerning Ceratitis capitata Wied. and among other things, evidence has

been achieved of the higher efficacy from the use of substerile males in comparison with entirely sterile insects, in the frame of a biological control which employs sterile males. (Fig. 2).

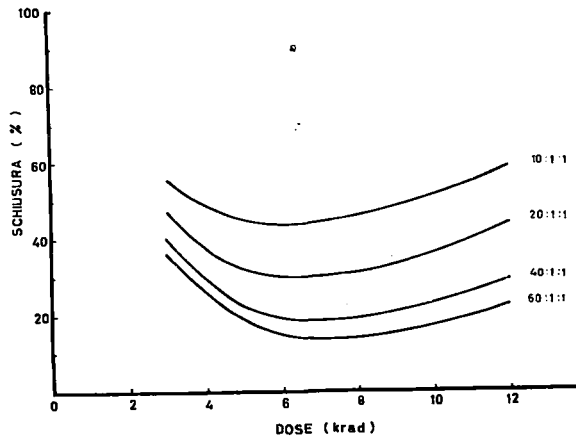

Fig. 2 - Ceratitis capitata Wied.: Pattern of egg hatching, as a function of sterilizing doses, for different ratios between sterile males and normal couples.

D. Two experimental stations equipped for meteorological surveys have been set up in a typically olive-grown area in Liguria. In these stations studies have been started on Dacus oleae Gmel. biology, which is not yet well-known.

Moreover population researches have been begun by means of the technique of the adult capture, marking with fluorescent pigments, release and recapture with chromotropic traps.

The information gained will make up the basis for improving the knowledge of the female and male behaviour with the view of a possible control of this very injurious Trypetid with the sterile-male technique.

On this subject there is a publication in the press:

CAVALLORO R., DELRIO G. - Fertility increment of Dacus oleae Gmel. in continuous rearing. - Experimental Notes of Applied Entomology, Perugia.

CAVALLORO R., DELRIO G. and ANSELMINI L. - Evaluation standard of the efficacy of sterile and substerile males for the insect control, with particular regard to Ceratitis capitata Wied. - Experimental Notes of Applied Entomology, Perugia.

DELRIO G. - A new generation of pesticides. - Quintessenza, IX, n. 22, pp. 6-14.

Contract No. 115-72-1 BIO D

Institut für Genetik, Johannes Gutenberg-Universität, Mainz, Germany
Prof.Dr.H.Laven, Director

Development of genetical control systems in pest insects.

Project No.1 : Mosquitoes.

In preparation of a field experiment for control of Culex pipiens fatigans in India strains were developed with incompatibility and translocation complexes (integrated strains), To ensure the highest possible adaptation of such strains to the local environmental conditions, the genome of a Delhi population was used and transferred into cytoplasm of a Paris strain. Methods have been developed to direct the chromosome transfer and to reduce the number of generations needed for this procedure. The field experiment conducted in August - October 1973 in a village near Delhi was a full success and has proven that this genetical system is much superior over sterile male technique.

Project No.2 : Mediterranean fruitfly.

Work was interrupted during 1973 due to conditions beyond our control, but will be resumed during 1974.

Project No.1

Title: Genetical systems for control of mosquitoes.

Research workers: Prof.Dr.H.Laven, B.S,Krishnamurthy, J,Kutsche-Ohmann,

1.1. Development of integrated strains of Culex pipiens fatigans for a field test.

Integrated strains of Culex pipiens having bilateral incompatibility with a local population and containing a double translocation complex with a high degree of sterility can be used for releases without separation of the sexes. Incompatibility will eliminate the wild population. It is replaced by the released integrated strain with a low reproductive potential and therefore a restricted population size. For two reasons such strains must be constructed with chromosomes from a local strain, first to give the integrated strain the best possible adaptation to the environmental conditions of the experimental area, second to make sure that the release strain has not a higher vectorial capacity for filariasis than the wild population.

Several such strains have been developed which are incompatible in both crossing directions with Indian wild populations because their cytoplasm is derived from a Paris strain. Chromosomes of a local Indian strain with a double translocation system and approximately 70% sterility were transferred into the Paris cytoplasm via a strain from Bangkok. This procedure, i.e. the transfer of the Indian chromosomes into the strain Bangkok and the transfer from there into the strain Paris, needs for each of the two steps at least five generations of backcrossing according to chromosome number and frequency of crossing over. By the use of special strains with rotational translocation complexes the procedure could be shortened to a total of four generations instead of ten. At the same time the occurrence of crossing over was much reduced or most likely totally suppressed. The strains obtained in such a way had a high degree of adaptation to local conditions, a vectorial capacity identical with that of wild populations and a fairly good competitiveness.

1.2. A field experiment with an integrated strain for control of Culex pipiens fatigans.

In a village southwest of Delhi (India) with a wild mosquito population of 6 - 20,000 Culex p. fatigans 5,000 males of our integrated strain were released every day from on August 4, 1973. The percentage of sterile egg rafts was already 28.4% in the second week. A doubling of the number of released males had no influence on the increase of sterility, It reached 53.1% in the fourth week. With 65% sterile egg rafts in the fifth

week a peak was reached and for five more weeks the sterility oscillated in the sixties. But from regular counts of pupae and egg rafts produced in the village it became obvious that the population was steadily declining to almost zero in week 11. This population decline and extermination was due on the one hand to the loss of production through the sterility imposed by the genetical system, The remaining production of only about 35% of the normal number of young larvae was almost totally consumed by the larvae of the predacious mosquito species Culex (Lutzia) fuscanus. This experiment has gives valuable information for the planning of future control programmes. (The experiment was conducted in collaboration with the WHO-ICMC Research Unit on Genetical Control of Mosquitoes in Delhi, India.)

1.3. Screening for viable homozygous translocations.

In the report for 1972 from this laboratory it has been stated that out of 7 female-linked translocations 3 could be made homozygous. The strain of Culex pipiens used was that from Paris. A similar attempt with translocations in a Delhi strain was without success. 5 autosomal and 4 female-linked translocations were not viable in homozygous condition. The reasons for this difference are not yet understood. There was also another difference observed between the two strains. In the Paris strain crossing-over between the sex determining factor and the break point of a translocation never has been observed in several thousands test crosses, but in the Delhi strain it occurred with 1.6 - 13.6%. The reason for this difference in crossing-over frequency is presently under study, The answer to this problem has obvious bearing on the technique for the development of stable translocation lines.

Contractant van de Commissie: Instituut voor Plantenziektenkundig
Onderzoek (I.P.O.), WAGENINGEN, Nederland
Nummer van het contract: 098 - 72 - 1 BIO N
Hoofd van het researchteam: dr. ir. J. Ticheler
Algemeen onderwerp van het contract: Bestrijding van de uievlieg, Hylemya
antigua (Meig.), met behulp van de "sterile-male" techniek.

In a third sterile insect release experiment the onion fly population has been lowered to 400 hibernating pupae (= 0.03 pupae per m²). This severe reduction has been achieved with a ratio of sterile to fertile flies in the field of 10 : 1. The flies have been released weekly in constant numbers, irrespective of the actual flight curves of the natural population which are difficult to predict.

Mass rearing stopped in June, when five million pupae were produced with a maximum of one million per month. Noteworthy is the constant output of good quality pupae.

The competitiveness of irradiated flies has been checked again because this year the pupae were irradiated in a ⁶⁰Co source. Under laboratory conditions the sterilized males proved to be at least equal to not sterilized males.

In mark-release-recapture experiments aiming at the estimation of the parameters in a simulation model for fly dispersal, 6 600 labeled flies have been recaptured. This number permits good estimations to be made. On three fields the reproduction of the onion fly has been studied. The data require further analysis.

Histologically the effects of different temperatures on a.o. the development of the ovaries have been investigated. Other studies involved the development of testes and ovaries during the larval stage, the effects of low doses of radiation on the gonads and, using electron microscopy, the spermatogenesis.

An important discovery was made when onion flies were shown to feed on flowering grasses.

Research carried out by University students contributed to the elucidation of the induction of diapause, the reaction to attractants, the influence of various factors on egg production, the quantitative reaction on temperature during pupal development and the reproduction of the onion fly in the field.

Publications :

- Theunissen, J. 1973. Egg chamber development in the onion fly, *Hylemya antiqua* (Meigen). *Int. J. Insect Morphol. & Embryol.* 2, 87-99
- Theunissen, J. (in press). Chromatin transformations in the trophocytes of the onion fly, *Hylemya antiqua* (Meigen), during egg chamber development. *Int. J. Insect Morphol. & Embryol.*
- Theunissen, J. (in press). Effects of temperature on egg chamber development of the onion fly, *Hylemya antiqua* (Meigen). *Ent. Exp. Appl.*
- Theunissen, J., Loosjes, M., Noordink, J.Ph.W., Noorlander, J., and Ticheler, J. (in press). Small scale field experiments on "sterile male" control of the onion fly, *Hylemya antiqua* (Meigen). "Sterile male technique for control of fruit flies" (Proc. Panel, 1973), IAEA Vienna.
- Theunissen, J., Loosjes, M., Noordink, J.Ph.W., Noorlander, J., and Ticheler, J. (in press). Genetic control of the onion fly, *Hylemya antiqua* (Meigen), in the Netherlands. *Proc. 7th British Insecticide & Fungicide Conf.*, (1973), 3.

Project no. 1

Control of the onion fly, *Hylemya antiqua* (Meig.), by means of the sterile male technique.

General (J. Ticheler)

In 1973 the third release experiment with sterile onion flies has been carried out. This experiment took a major part of the time of the members of the team, which caused them to have less time available for their specific projects. For the collection of the data we were glad to have the cooperation of Miss H. de Zwaan and of Messrs. R. van der Leeuw, G. Schelling and D. Sipahelut. The hospitality of the SNUiF (Dutch Onion Federation) at Middelharnis, from whose headquarters the ecology of the onion fly was studied, is, again, gratefully acknowledged.

The release experiment (J. Ticheler)

Depots containing diapausing pupae, installed the preceeding autumn, indicated the emergence pattern of the wild population. At the experimental site the first flies appeared on May 3rd, five days after the unfolding of the leaves of the summer oak. In order to study the influence of soil cover on the emergence of the flies, depots have been placed in a crop of winterwheat and of sugar beet, and in bare soil. Data on the time at which 5, 50 and 95% of the flies had emerged are given in tabel 1.

tabel 1 Influence of soil cover on the emergence of the onion fly.

soil cover	5% emergence	50% emergence	95% emergence
winterwheat	17 May	14 June	5 July
sugar beet	13 May	29 May	14 June
bare soil	10 May	27 May	11 June

As expected there was little difference between the late developing sugar beet and bare soil. Winterwheat, however, has a considerably delaying effect on the emergence because of its early coverage of the soil and the corresponding decrease in soil temperature.

Also at the Schuilenburg, Lienden, the third of a series of sterile release experiments has been carried out. While, during the first two years (Ann. Rept. 1971 and 1972), the sterile pupae were brought in the field according to a schedule that aimed at following the flight curves of the wild population, in 1973 a schedule was followed providing for a constant number of sterile flies in the field. During the whole season weekly 100 000 pupae have been brought to the field. It was necessary to adapt the method of bringing the pupae in the soil to their in comparison with previous years much bigger numbers, which, moreover, had to be provided with a dye mark. It took a considerable amount of time and of pupae before a method was developed which prevented serious pre-

dation by birds.

The results are summarized in table 2, for comparison the results of 1971 and 1972 are included.

table 2 Summary of the results of three release experiments

	estimated wild population in spring (pupae)	average number of weekly released pupae	flies ')	av. % sterile flies in population	% infested onion plants
1971	20 000	27 700	25 000	56.0	5.22
1972	17 000	50 500	32 400	67.8	0.60
1973	5 000	104 800	84 700	91.1	0.12
1974	400				

1) flies emerged in the field from irradiated pupae

From the figures it is clear that the onion fly population, measured as number of hibernating pupae, underwent an important reduction. During the years the damage decreased also with a factor 50. The percentage egg sterility, in 1971 and 1972 closely linked to the percentage of sterile flies in the population, was, in 1973, much more difficult to determine. Only few fertile females were caught and these laid few eggs with variable egg sterility. A small number of already mated female immigrants can have had a relatively big negative influence on the egg sterility. From the results of the three experiments it has been calculated that the difference between the egg sterility and the sterility in the fly population can be explained by the assumption of a yearly immigration of 2 000 - 6 000 flies of which the females had already mated. Kitchen gardens of which a number are at less than the assumed maximum flight range of 2 km could be responsible for these immigrants.

At a distance of 800 m from the experimental plot a check plot of 0.6 ha of onions has been sown. Here a fertile fly population has developed from 13 000 pupae, labeled with ^{65}Zn . Sterile flies migrated from the experimental plot to the check plot, resulting in an average sterility of the fly population of 59%. Onion fly infestation on the check plot was 9 times higher as on the experimental plot. Although considerable numbers of larvae were found in infested onions, soil samples taken at harvest time contained very few pupae, so few that we wondered whether the plot, until recently an orchard, contained a high level of pesticide residu. As a consequence, the check plot did not come up to expectations.

Mass rearing (J. Noorlander)

The planning of the mass rearing of the pupae needed for the third field experiment proved to be more realistic than in previous years. The rearing covered a period from September '72 till July '73. During

this 10 month period 5 000 000 pupae have been produced. As the initial field collected group of pupae is rather small, rearing of the required quantity involves a number of generations. Actually the fourth laboratory reared generation is used for field release. Breeding through the F_1 , F_2 and F_3 takes considerable time. This year we have been able to rear the F_3 generation for both 1973 and 1974. This means a quick start for 1974 as only one generation has to be reared.

The reproduction factor of the fly in the laboratory is around 10. The quality of the pupae produced is satisfactory.

So far the preparation of the larval diet has been done in a 3 l. Waring blender. This machine getting worn, the use of a concrete mixer and of an industrial mixer has been tried out. The medium prepared in the concrete mixer did not meet the requirements of the larvae, particularly as regards the structure (consistency), resulting in pupae of less than the desired weight. By sieving out the smaller pupae, the average weight of the pupae could be redressed to normal, at the cost, however, of a low percentage result from egg to pupa of 46% only. As climate rooms became available for the mass rearing, egg production per female more than doubled. The light intensity in the cages is positively correlated with egg production. Under artificial light distribution of the flies in the cage has improved, resulting in the insects to be more quiet, to live longer and to function more efficiently.

The increased output of the mass rearing has been realized by improved efficiency, by better and more dependable rearing conditions, by using more fly cages, by adding extra labour during week-ends and by labour from other members of the team. This year again the mass rearing went off very smoothly. Big variations in production did not occur.

Radiobiology and radioisotopes (J.Ph.W. Noordink)

With the aim of assessing the influence of the size of flies on mating and reproduction an experiment has been carried out comparing a group of big females caged with small ^{32}P labeled males and big not labeled males with a group of small females caged with big ^{32}P labeled males and small not labeled males. In both groups big and small males had to compete and mating by either of them could be established by autoradiography of the eggs which were collected twice weekly. It appeared that females mated with males of their own size produced more eggs than females mated with males not their own size. Big females produced considerably more eggs than small females of which, moreover, the eggs showed a reduced fertility. One may conclude that for optimal rearing one should use big insects of homogeneous size.

We investigated the possible influence of labeling with ^{65}Zn on fecundity and fertility. Therefor labeled specimens were put together in

equal numbers with unlabeled specimens of the other sex. The average radioactivity of the labeled flies was 300 c/min. Unexpectedly the fecundity of the labeled females was higher, whereas in the cross of radioactive females and radioactive males the fertility lagged somewhat behind. The experiment showed also that the F_1 of ^{65}Zn labeled females could be distinguished autoradiographically from the progeny of not labeled onion flies.

In 30 m³ field cages we tried again to get onion fly infestation, this year with more success than in previous years. A part of the cages has been planted with grasses, grain and different flowering dicotylidons, the other years onions only had been planted. In the laboratory it appeared that flies stayed alive and laid fertile eggs when given sugar, water and flowering Timothee grass (*Phleum pratense*). This explains better their survival in the field in spring than feeding on pollen of Umbelliferae which are then scarce around onion fields.

As in the sterile release experiment large numbers of flies (100 000 per week) had to be released, irradiation took place with the ^{60}Co source of the Pilotplant for Food Irradiation instead of with the electronegenerator of the ITAL which has a much smaller capacity. The effect of the ^{60}Co irradiation had been tested in two competition experiments, in which a number of females were mated with an equal number of normal and irradiated males. In the first experiment the egg fertility was 38% against 92% for the check with normal insects only, and in the second 43 and 95% respectively, which means that the ^{60}Co source is suitable for the sterilization. Again, it appeared that in the check cages the females laid fewer eggs than in the cages with irradiated males.

It is difficult to identify onion fly infestation in the field without pulling out suspected plants. Therefore, in a growth chamber trays were seeded with onions which were infested with eggs at various points of time. Infestation symptoms were recorded on a series of photographs.

Ecology of the onion fly (M. Loosjes)

A few experiments have been carried out with attractants and other trapping methods. Catching flies in a liquid or with sticky traps proved unattractive as identification of these flies is very time consuming and, moreover, the check on a dye label is unreliable. Placing an attractant (n-propyl disulfide) screened off with gauze under a flight interception trap offers better perspectives. Rotting onion sap can be at least as attractive, but it can not be standardized.

The simulation model for the dispersal of the flies has been further improved so as to allow a more accurate choice of the various parameters

in the model. Two experiments have been carried out in order to obtain more data for the model. In the first experiment flies have been released in four different directions at a distance of a small isolated onion field. In the second experiment flies have been released in one direction at various distances of an isolated onion field. In total 296 900 flies labeled with 19 different colours and colour mixtures of day glow dye powder emerged from the pupae, of which 6 600 have been recaptured. The flight speed lies in the same order of magnitude as in previous experiments, and, again, the recaptures indicate that the flies move upwind to the onion fields. The size of the catch is correlated with the daily maximum temperature. As the catch depends, among others, on the flight activity, a similar relation exists. This relation is used in the simulation model.

Analyses of observations of individual flies in onion fields showed that in the crop flight direction is independent from: a) the direction where the observer stands, b) the direction of the sun, and c) the direction of the previous flight of the same individual. There seemed to be some preference for flying upwind.

In the field it was shown that onion fly females mate for 100% during the first 10-14 days. Females emerged and recaptured outside an onion field appeared to mate significantly later than females emerged and recaptured inside an onion field. On the basis of ovary development and number of eggs in the ovaries of recaptured females of known age, tentative assumptions could be made on the frequency of egg laying.

On three more or less isolated onion fields the numbers of flies and pupae have been estimated in view of the determination of the reproduction factor and of the percentage diapause. The data are being analyzed. The ratio of pupae in soil samples of 5 and 20 cm diameter around an infested plant was on the average 46 : 100, as had been assumed on the basis of data on the distribution of pupae in the soil in relation to infested plants.

Histological studies (J. Theunissen)

Autoradiographic study of normal and pathological spermatogenesis has been completed with a series of preparations of irradiated, ³H thymidin injected males. It appeared that also irradiated cells take up thymidin, especially somatic cells. In certain gonad cells the thymidin is taken up initially, but because of the total inhibition of the development of these cells and their subsequent degeneration, the thymidin is released again from these cells.

The ovarian development of onion flies at different temperatures has been studied. The results are being published.

Repeating an earlier experiment concerning the effects of irradiation

of onion fly pupae with low doses of X rays, groups of pupae have been irradiated with 0 (check), 0,5, 1,0, 1,5 and 2,0 kR. Every second day 10 males and females have been fixed and checked on mating. The egg production per group has been registered together with the fertility of the eggs. These data, see table 3 experiment II, may be compared with those from the previous experiment I.

table 3 Irradiation experiments with low doses of X rays

fecundity of irradiated females, expressed in percentages of the egg production of untreated females.

dosis	0	0,5	1,0	1,5	2,0 kR
exper.					
I	100	130,3	58,4	11,9	0,04
II	100	123,4	39,3	2,0	0,009

fertility of irradiated females, expressed as percentage egg hatch.

dosis	0	0,5	1,0	1,5	2,0 kR
exper.					
I	81,4	36,6	9,3	12,6	0
II	87,8	36,4	7,6	3,1	0

average weight in mg of 500 eggs (experiment II)

dosis	0	0,5	1,0	1,5 kR
	35,1±2,2	35,1±1,4	38,5±2,8	80,6±23,1

It is a remarkable phenomenon that the fecundity of females irradiated with 0.5 kR is considerably higher than of not irradiated females. The condition of light stress as a consequence of the irradiation induces possibly the organism to react with a higher egg production. Irradiation with 1.5 kR causes a large variability in size and shape of the eggs deposited. Also their weight differs strongly from the eggs of the check insects. The histological preparations show that spermatogenesis is already reduced at a dose of 0.5 kR, recovery, however, takes place. After irradiation with 1.0 kR recovery symptoms appear too late to have any significance for the reproduction. After irradiation with 1.5 kR no recovery has been observed.

With the much appreciated cooperation of Mrs. Tamar Orion of Tel Aviv University, the development of the larval gonads has been studied. Gonads have been found in freshly emerged larvae and four days later the first stages of differentiation between male and female gonads were observed. In the testis of eight day old larvae the apical complex could be found, which appeared in younger animals as a group of migrating somatic cells of the testicular sheath.

Investigation of spermatogenesis, using the electronmicroscope continued.

Other research topics

A number of aspects of the biology of the onion fly could be studied thanks to the cooperation of university students. Based on the study of B. Bol (Ann. Rept. 1972) P. Wolff (Univ. of Utrecht) developed a method for testing the olfactory response of onion flies to different attractants. Continuing along the lines of the work of W. Kelderman (Ann. Rept. 1971) P.M.J. Ramakers (Agric. Univ. Wageningen) studied the influence of the photoperiod in relation to temperature on the induction of the pupal diapause. A. Houwing (Agric. Univ. Wageningen) finished his investigations on egg production and on pupal development. J. Huber and J. Roest (Univ. of Utrecht) studied aspects of population dynamics, while J.M. den Breeje (Agric. Univ. Wageningen) and Miss Y. Schwencke (Univ. of Utrecht) cooperated in the study of fly dispersal.

Optimal egg production (A. Houwing)

In an experiment the influence of various factors on the egg production has been investigated. In a conditioned room a high light intensity (25 W/m^2) has a stimulating effect on the egg production per cage. The egg production per cage increases linearly within the range of the fly densities used. Per female, however, the egg production decreases considerably. The decrease is completely accounted for by the shorter life span at higher densities. The results of the experiment indicate that the life span of the flies may be increased by a better nutrition. This should lead to a higher egg production.

Pupal development and the emergence of flies (A. Houwing)

At temperatures ranging from 4 to 22°C the speed of development of onion fly pupae has been determined. Extrapolation of the straight part of the speed of development curve gives a value of 9°C for the threshold of development. With this threshold as base, temperature sums have been calculated for diapausing pupae dug in in the field for two consecutive years. For the time till 5 and 50% emergence identical temperature sums have been found for the two years. The time till 50% emergence corresponds with the temperature sum found in the laboratory for temperatures between 14 and 18°C. For the beginning and the end of the emergence, however, the time was shorter and longer respectively than calculated. The temperature sum approach, therefore, is still not reliable enough for forecasting the emergence of the onion fly in the field.

Population dynamics (J. Huber)

In 1972 study of the actual reproduction of onion flies on a sandy soil has been started. Drawing of conclusions has been hampered because the field appeared not as isolated as was initially assumed. Moreover, only incomplete data on the egg deposition were obtained. The estimate of 20 eggs per female is, therefore, rather unsure. The survival from egg to pupa was estimated at 20%. The number of pupae could be determined accurately. Infestation was clearly more intense on the verges of the field over a width of 5-10 m. The density of diapausing pupae amounted to 250 per m^2 and the percentage of infested plants to around 40%.

Associato della Commissione: COMITATO NAZIONALE ENERGIA NUCLEARE

Laboratorio Applicazioni in Agricoltura

N° del contratto: 107 - 72 - 1 BIO I

Capo del gruppo di ricerca: prof. A. BOZZINI

Tema generale del contratto: Biological control of medfly by sterile-insect technique in Procida island.

Breve descrizione generale dei lavori compiuti:

The Procida Medfly pilot experiment was continued in 1973 with the released of about 40 millions of sterile flies following a new strategy of control. Large cloth cages, each containing approximately 100.000 insects, were irradiated in the gamma irradiation plant of Agricultural Applications Laboratory of CNEN's Casaccia Center at a dose of 10.000 rad (\pm 10%) and sent weekly to the island. In the laboratory studies regarding the quality control of irradiated flies, the modification of egg incubation, cheaper larval diet and, the mechanization of rearing procedures have been done.

Risultati del progetto n. 1

Capo del Progetto e collaboratori scientifici: dr. U. CIRIO

dr. I.D. DE MURTAS

Titolo del progetto: Biological control of med-fly sterile-insect
technique in Procida island

Descrizione dei risultati:

In 1973 the objectives of the program was to suppress medfly in Procida by using a limited number of sterile insects in connection with the criteria of the control strategy. This was divided into a sequence of five periods.

I) The first period was devoted to reducing the overwintering population by destruction of sour oranges and intensive sticky trapping. This latter work began at the end of 1972 in order to eliminate the adult population and to avoid the problems dealing with the application of insecticides on the island. In order, however, to follow the development of the natural medfly population about 10% of the sour oranges remained on selected trees.

II) The second period was devoted to repressing the reproductive rate of emerged flies by using massive releases of sterile insects. The timing of the application of sterile male technique was established by:

- the emergence of the first flies pupae collected regularly during the winter and spring time from infested sour oranges (key host in Procida)
- the first flies captured in the sticky traps which remained in the field until the first newly emerged wild flies were captured
- the weather conditions.

The duration of the release time, however, was carried out for 2 months after the last record of flies emerging from the pupa collected from the sour oranges. During this time it was assumed that

the flies can have about two generations in the field. The criteria of release was the use of about 10.000 sterile flies/week/ha which were distributed in the beginning of the overwintering medfly areas and afterwards on all Procida cultivated areas.

III) The third period was dedicated to checking the newly emerged adults which were coming from the importation of infested fruits to the island and from the ovideposition of gravid females which immigrated from the nearby areas. This was done in order to establish the beginning of the second release phase. It was accomplished by checking the flies emerging from infested fruits both collected in the field and found in fruit markets. Also, 300 sticky traps were placed in the field 20 days after the latest release of insects in order to reduce the number of immigrant males. The 20 day period was chosen because of the short life of sterile male flies during the summer months. All traps were removed a few days before the beginning of a new distribution of sterile medflies.

IV) The fourth period was devoted to repressing the reproductive rate of the resurgung local medfly population by releasing sterile insect for about two months.

V) The fifth period will again be dedicated to reducing the overwintering medfly population.

The releases of sterile insects were made along all roads of Procida by using small cars which carried 2 adult cloth cages set up an opened on the top. The period of releases and the number of the sterile flies distributed are given in fig. 1. The results of the experiment were determined with a quantitative comparison of the degree of fruits infestation and the number of the wild flies captured in Procida and the control areas of Monte di Procida, Ischia and Capri (tab. I and fig. 2).

The data obtained showed that the ecological basis to control the medfly by sterile insect technique appears very important in order to reduce the number of sterile flies and to combine this technique with other more simple control methods.

Publications

CIRIO U.- Basi ecologiche per un programma di lotta contro la Ceratitidis capitata Wied nell'isola di Procida.
(in press)

CIRIO U. - The Procida medfly pilot experiment: present status of the medfly control after two years of sterile insect releases. Proceed. FAO/IAEA Panel on the sterile Male technique for control fruit flies. Vienna, 12-16 November 1973 (in press).

TAB. I - RESULTS OF FRUIT INSPECTION FOR MEDFLY INFESTATION IN THE
RELEASE AND CONTROL AREAS.

MONTH	H O S T F R U I T S E X A M I N E D					
	APRICOT		PEACH		PEAR	
	A	B	A	B	A	B
<u>ISLAND OF PROCIDA</u>						
June	7975	0.0	13803	0.0	-	-
July	4890	0.0	14761	0.0	8725	0.0
August	110	0.0	12413	0.4	13240	0.0
September	-	-	12472	0.0	3900	0.0
October	-	-	2952	23.6	550	0.0
<u>MONTE DI PROCIDA^a</u>						
June	681	0.0	145	0.0	32	0.0
July	2589	6.0	362	0.8	573	0.7
August	262	80.1	50	32.7	739	17.0
September	-	-	25	64.0	360	33.0
October	-	-	-	-	477	50.1
<u>ISLAND OF ISCHIA^a</u>						
June	205	0.0	40	0.0	-	-
July	373	3.2	217	0.2	214	0.0
August	72	22.2	195	22.6	203	2.0
September	-	-	619	69.8	196	24.4
October	-	-	280	82.0	-	-
<u>ISLAND OF CAPRI</u>						
June	-	-	-	-	-	-
July	385	1.0	1250	0.0	650	0.0
August	-	-	755	40.0	930	0.0
September	-	-	175	86.6	-	-
October	-	-	143	100.0	-	-

a = Data from dr. Fimiani, Istituto Entomologia Agraria, Portici, Napoli

A = No. of fruits examined

B = percentage of infested fruits

- = unknown data

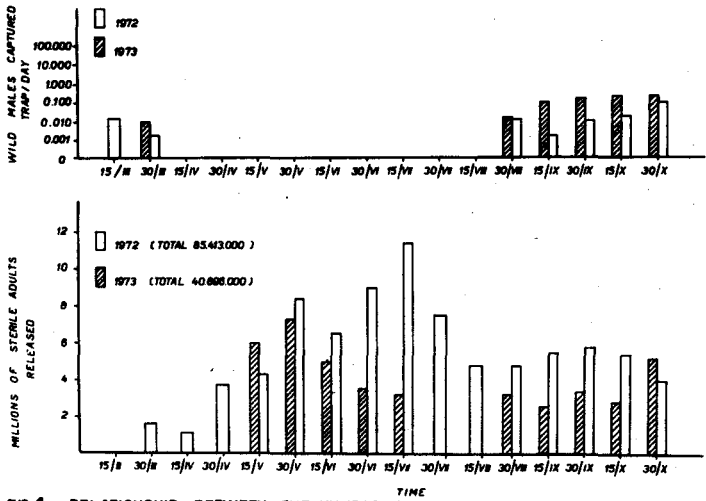

FIG. 1. RELATIONSHIP BETWEEN THE NUMBER OF WILD CAPTURED AND THE NUMBER OF STERILE MEDFLY RELEASED DURING THE PILOT EXPERIMENT OF PROCIDA ISLAND (ITALY)

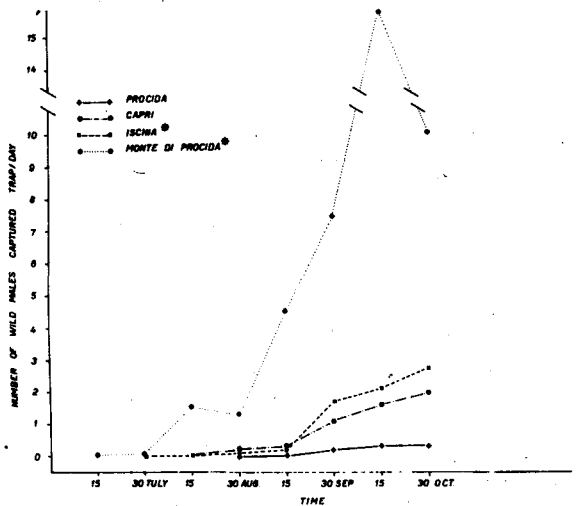

FIG. 2. NUMBER OF CAPTURED WILD MALES ON PROCIDA AND CONTROL AREAS (1973)

* DATA FROM Dr. FIMIANI, Istituto di Entomologia Agraria, Portici (NAPOLI)

V.

FORSCHUNGSTÄTIGKEIT ANWENDUNGEN MEDIZIN

RESEARCH ON APPLICATIONS IN MEDICINE

RECHERCHES RELATIVES AUX APPLICATIONS MEDICALES

NUKLEARMEDIZIN

NUCLEAR MEDICINE

MEDECINE NUCLEAIRE

Vertragspartner der Kommission: Universität Ulm

Abt. NUKLEARMEDIZIN (Radiologie III)

Nr. des Vertrags: 116 - 72 - 1 BIOD

Leiter der Forschungsgruppe: Prof. Dr. W. E. Adam

Wissenschaftliche Mitarbeiter: Dr. F. Bitter, Dr. Ch. Horn,
Dr. G. Meyer, Ing. R. Weller

Allgemeines Thema des Vertrags: Entwicklung eines nicht traumatisierenden Verfahrens zur Analyse der Herzkinetik mit Hilfe der quantitativen Funktionsszintigraphie und Anwendung simulierender Verfahren

Im Jahre 1973 konzentrierte sich die Arbeit der physikalischen Arbeitsgruppe auf die Vervollständigung der Soft- und Hardware zur Durchführung des Time-averaging-Verfahrens.

Die medizinische Arbeitsgruppe untersuchte folgende Fragen:

- 1) Kann das einfacher zu handhabende ^{99m}Tc-Technetium-Pertechnetat das Technetium - Albumin ersetzen?
- 2) Lassen sich die Kurven, die über dem Herzen gewonnen werden, reproduzieren?

Die an 32 herzgesunden Patienten durchgeführten Untersuchungen hatten folgende Ergebnisse:

Das Technetium - Albumin ergibt besser reproduzierbare Zeit-Aktivitätskurven. Die vom gesamten Herzen gewonnenen Kurven sind gut reproduzierbar, ebenso die die über dem linken Ventrikel gewonnenen. Die Reproduzierbarkeit der über der rechten Herzhälfte gewonnenen Zeitaktivitätskurven ist nicht so gut. Das ist erklärbar durch die geringere Auswurftrate des rechten Ventrikels. Während wiederholte Untersuchungen über gleichen Herzabschnitten gut reproduzierbare Ergebnisse bringen, ergibt der Vergleich der Kurven von verschiedenen Herzabschnitten signifikante Änderungen der Kurvenform.

B e r i c h t der Physikalischen Arbeitsgruppe

Hardware

Die Platte (RF08/RS08) wurde 1973 (Hardware und Software) in das vorhandene Rechnersystem integriert (s. Anlage 1). Mit einem selbst konstruierten EKG-Gerät (s. Anlage 2) ist es möglich, sowohl von der R-Zacke abgeleitete Triggerimpulse in den Rechner zu übernehmen (zur Erstellung der Phasenbilder), als auch die Injektion bei Herzkatheteruntersuchungen zu synchronisieren. Zur Entlastung wurden von der Universität 1973 eine zweite Szintillationskamera (Nuclear Enterprises) beschafft, die ebenfalls an den Rechner angeschlossen ist.

Software

Folgende Programme wurden speziell für das Projekt entwickelt:

- 1) EKG Das Programm erlaubt die Einstellung einer Triggerschwelle, so daß bei der späteren Untersuchung die Aufnahme der Phasenbilder mit der R-Zacke gestartet wird. Außerdem wird die mittlere Periodendauer (RR-Abstand) der Herzrevolution festgestellt:

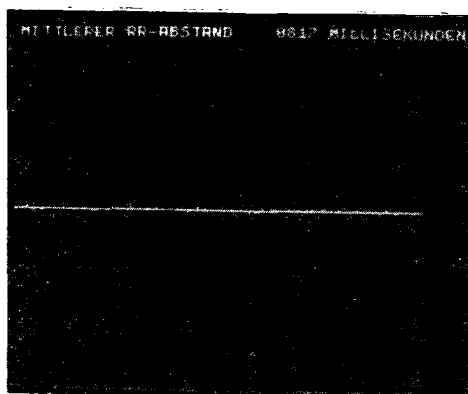

2. DIR-AV

Das Programm dient zur Aufnahme der Phasenbilder des Herzens. Die Meßzeit für eine Phase beträgt dabei (RR-Abstand) /15 und richtet sich nach der Zahl der Bilder, die im Kernspeicher aufgebaut werden. Die Meßzeit ist somit auf die Herzfrequenz des Patienten normiert. Im Verlauf der Untersuchungen zur Reproduzierbarkeit zeigte sich, daß eine Registrierung der echten Meßzeit für jedes Phasenbild notwendig wird zur Durchführung einer Korrektur. Diese Korrektur macht alle Phasenbilder miteinander vergleichbar. Ohne Korrektur wären ca. 20 % der Untersuchungen nicht verwertbar. Es war ein besonders großer Programmieraufwand erforderlich, da es sich hier um Real-Time-Anwendungen handelt.

3) CORRE

Zur Überprüfung der Reproduzierbarkeit werden 2 Untersuchungen am Patienten nacheinander durchgeführt. Nach Auswertung erhält man Kurven die den Aktivitätsverlauf über dem Herzen (getrennt für rechtes und linkes Herz) während der Herzrevolution zeigen. Die Kurven der beiden Untersuchungen werden durch eine Korrelationsrechnung verglichen:

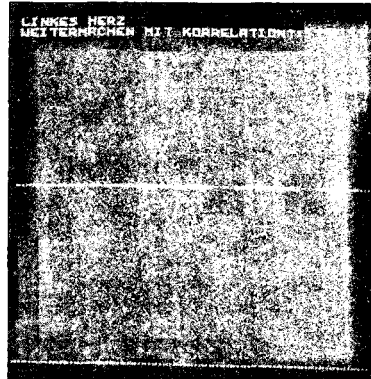

Außer den angeführten Programmen werden alle Datenerfassungs- und Verarbeitungsprogramme der Abteilung zur Durchführung des Projekts eingesetzt.

B e r i c h t der Medizinischen Arbeitsgruppe

Betrifft: Arbeitsplan I.2

Die Untersuchungen wurden ausschließlich an klinisch herzgesunden Patienten durchgeführt, die uns zur Hirnszintigraphie zugewiesen wurden. Wir benutzten die Zeit zwischen Injektion und ausreichender Anreicherung des Tracers im Hirn zur Datenermittlung.

Die Patienten blieben während der Untersuchung liegen. Die Kamera wurde parallel zum Körper und um 35° im zweiten schrägen Durchmesser über dem Thorax positioniert. Als Tracer diente in der ersten Untersuchungsreihe freies Per technetat. Wir injizierten bei 17 Patienten zwischen 11,0 und 14,0mCi in 0,25 bis 1,1ml i.v. In der zweiten Untersuchungsreihe wurden bei 15 Patienten zwischen 11,0 und 15,0mCi Per technetat an Human-Albumin gebunden in 0,3 bis 1,0ml i.v. injiziert. Mit der Injektion wurde über die Kamera der Computer gestartet. Der erste Durchlauf wurde jeweils auf 370 Bildern (octal) zu 130msec., Gesamtzeit 32,5 Min. festgehalten. (s. Software). Gleichzeitig wurden 8 Polaroidbilder gezogen. Anschließend begann bei der Untersuchung mit freiem Per technetat das Averaging (s. Software). Meßzeit 2 x 20 Min. oder 2 x 2000 Herzaktionen (octal).

Für die Datenvermittlung während der Untersuchung mit Technetium-markiertem HSA wurde das Programm erweitert. Nach dem ersten Durchfluß wurden 100 Bildern zu 3 Sek. gespeichert, um die Homogenisierung des Tracers im Blut und die Abwanderung aus dem Blut verfolgen zu können. Nach dem 1. und 2. Averaging wurden zusätzlich 20 Bilder gespeichert. Meßzeit pro Averaging 1000 Herzaktionen (dezimal).

Auswertung

Am Display wurden die "Areas of Interest"-Einflußbahn, rechtes Herz, Lunge, linkes Herz, Aorta-festgelegt. Durchflußkurven und mittlere Transitzeiten wurden bestimmt. Für dieselben Areas wurden dann die Averaging-Kurven ermittelt. Anschließend wurden die absoluten Werte für rechtes und linkes Herz ausgedrückt, die Differenz zwischen Maximum und Minimum errechnet und in % des Maximums ausgedrückt. Die Herzkurven aus Averaging 1 und 2 wurden weiter über das "Programm zur Untersuchung der Reproduzierbarkeit von Herz-averaging" (s. Software) verglichen.

Ergebnisse

Bestimmung der Differenz zwischen Maximum und Minimum der Impulse über der rechten und linken Herzhälfte.

1) Freies Per technetat

a) rechtes Herz

Differenz zwischen Maximum und Minimum der Impulse. Mittelwert:
 5.929 ± 2.252 (1. Durchgang). Mittelwert: 5.094 ± 2.285 (2. Durchgang)
Im paarweisen Vergleich ergab sich zwischen den Werten des 1. und 2. Averagings keine signifikante Differenz ($p = 0.05$).

b) linkes Herz

Differenz zwischen Maximum und Minimum - Mittelwert: $10.988 \pm 2.894 \%$ (1. Durchgang), Mittelwert: $10.606 \pm 2.963 \%$ (2. Durchgang). Im paarweisen Vergleich zwischen den Werten des 1. und 2. Averaging keine signifikante Differenz ($p = 0.05$).

c) rechtes Herz / linkes Herz

Die Differenzen zwischen den Mittelwerten des rechten Herzens aus Averaging 1 u. 2 und den Mittelwerten des linken Herzens aus Averaging 1 u. 2 waren signifikant ($p = 0.001$).

2) ^{99m}Tc -markiertes Human-Serum-Albumin

a) rechtes Herz - Mittelwert: $6.531 \pm 2.198 \%$ (1. Durchgang)

Mittelwert: $6.915 \pm 2.159 \%$ (2. Durchgang). Im paarweisen Vergleich zwischen den Werten des ersten und zweiten Averaging keine signifikante Differenz ($p = 0.05$).

b) linkes Herz - Mittelwert: $17.654 \pm 3.883 \%$ (1. Durchgang) Mittelwert:

$16.739 \pm 4.278 \%$ (2. Durchgang). Im paarweisen Vergleich zwischen den Werten des 1. und 2. Averaging keine signifikante Differenz ($p = 0.05$).

c) rechtes Herz / linkes Herz

Die differenzen zwischen den Mittelwerten aus Averaging 1 und 2 des rechten Herzens und denen des linken Herzens waren signifikant. ($p = 0,001$).

Korrelationen

Die Korrelationen zwischen den Kurven aus Averaging 1 und 2 wurden über den paarweisen Vergleich der einzelnen Kurvenpunkte für rechtes, linkes und gesamtes Herz bestimmt.

1) Freies Technetium

a) rechtes Herz (Vgl. 1. und 2. Kurve). Mittelwert des Korrelations-

Koeffizient: $0.68098 \pm 0.22929 \%$. Bis auf 4 von 10 waren alle Koeffizienten signifikant ($p = 0.05$).

b) linkes Herz - Mittelwert des Korrelations-Koeffizient: $0.90437 \pm 0.06068 \%$
Alle Koeffizienten waren signifikant ($p = 0.01$).

c) gesamtes Herz - Mittelwert des Korrelations-Koeffizient: $0.84111 \pm 0.13225 \%$
Alle Koeffizienten waren signifikant ($p = 0.05$).

d) rechtes Herz / linkes Herz - Die Differenz zwischen den Korrelations-Koeffizienten für rechtes und linkes Herz waren signifikant ($p = 0.005$).

2) Tc-markiertes HSA

a) rechtes Herz - Mittelwert des Korrelations-Koeffizienten: 0.77769 ± 0.20030
Bis auf 2 waren alle Werte signifikant ($p = 0.05$).

b) linkes Herz - Mittelwert des Korrelations-Koeffizienten: 0.96461 ± 0.02876
Alle Werte waren signifikant ($p = 0.001$).

- c) gesamtes Herz - Mittelwert des Korrelations-Koeffizienten: 0.91615 ± 0.08987 %. Alle Werte waren signifikant ($p = 0.05$)
- d) rechtes Herz / linkes Herz - Die Differenz zwischen den Korrelations-Koeffizienten für rechtes und linkes Herz waren signifikant ($p = 0.005$)
- 3) Freies Tc / Tc-markiertes HSA
- a) rechtes Herz - Die Differenzen der Korrelations-Koeffizienten für die Kurven des rechten Herzens aus den Untersuchungen mit freiem und gebundenem Tc waren nicht signifikant ($p = 0.05$).
- b) linkes Herz - Die Differenzen der Korrelations-Koeffizienten für die Kurven des linken Herzens waren signifikant ($p = 0.05$)
- c) gesamtes Herz - Die Differenzen der Korrelations-Koeffizienten für die Kurven des gesamten Herzens waren fraglich signifikant ($p = 0.1$).

been achieved of the higher efficacy from the use of substerile males in comparison with entirely sterile insects, in the frame of a biological control which employs sterile males. (Fig. 2).

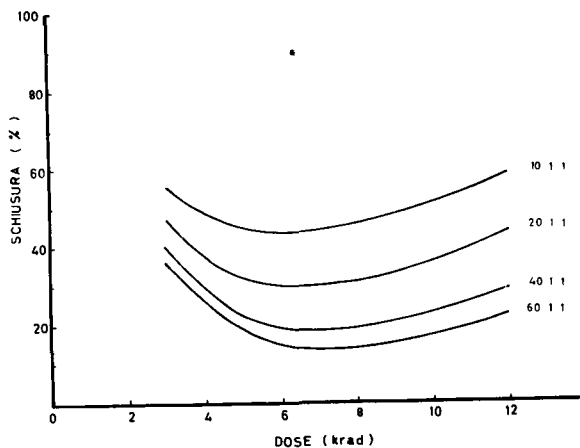

Fig. 2 - Ceratitis capitata Wied.: Pattern of egg hatching, as a function of sterilizing doses, for different ratios between sterile males and normal couples.

D. Two experimental stations equipped for meteorological surveys have been set up in a typically olive-grown area in Liguria. In these stations studies have been started on Dacus oleae Gmel. biology, which is not yet well-known.

Moreover population researches have been begun by means of the technique of the adult capture, marking with fluorescent pigments, release and recapture with chromotropic traps.

The information gained will make up the basis for improving the knowledge of the female and male behaviour with the view of a possible control of this very injurious Trypetid with the sterile-male technique.

On this subject there is a publication in the press:

CAVALLORO R., DELRIO G. - Fertility increment of Dacus oleae Gmel. in continuous rearing. - Experimental Notes of Applied Entomology, Perugia.

Risultati del progetto n. 5

Capo del progetto e collaboratori scientifici: Prof. R. Cavalloro, Dott. G. Delrio.

Titolo del progetto: Studi sul comportamento di femmine e maschi normali e sterili.

Studies on the behaviour of normal and sterile females and males.

(Researches made in 1973)

A. The causes of low fertility in laboratory rearing of Dacus oleae Gmel. have been studied, pointing out in particular the need for the insect to effect the piercing act for the laying of eggs and the necessity for the eggs to stay in the collecting water only for a short time.

Simple and practical improvements have been devised introducing little glass and paraffin balls of proper sizes and colour into the cage bottoms. The females are attracted by such balls and, after trying in vain to pierce them, they drop their eggs which prove more fertile.

In order to prevent eggs from staying too long in water (over 4 hours) a self-working apparatus was designed for collecting eggs periodically.

B. Several pabula for rearing Dacus oleae larvae have been tested, starting from a basic formula (Cavalloro, 1967) and trying to improve its composition.

A large number of diets are being experimented; however it is interesting to stress that propionic acid has proved more efficient among the different antiseptics products used for the control of infestions due to microrganisms.

C. A simple mathematic model has been developed for assessing the efficacy of males with different levels of sterility and distributed in various numerical ratios in the population to be controlled.

The model validity has been checked by means of experimental data concerning Ceratitis capitata Wied. and among other things, evidence has

little superior doses.

Lower doses are wanted to sterilize the insect in immature stages.

D. Considerable sensibility to gamma-radiations has been found on Gonocerus acuteangulatus Goeze (Rhynchota) adults.

The males of this species no longer mate over an 8 krad dose, at which only 19,3% lethal dominants is obtained. This is why investigations with substerilizing doses (4, 5, 6, 7, 8 krad) have been made on sterility transmission in following generations.

It was observed in this way that, in the F₁, insects show a higher sterility if compared with the irradiated parental generation.

Table 3. Inherited sterility in Gonocerus acuteangulatus Goeze.

GENERATION	PAIRS STUDIED	CORRECTED AVERAGE % EGG HATCH
P ₁ ♂ (8 krad) x N ♀	9	19.3
F ₁ ♂ x N ♀	6	5.8
N ♂ x F ₁ ♀	6	9.8
F ₁ ♂ x F ₁ ♀	9	4.2

Two papers on this subject are in the press:

CAVALLORO R., DELRIO G. - Radiosterilization of Dacus oleae Gmel. and control possibilities by the use of the sterile male technique. - Redia, Firenze.

CAVALLORO R., DELRIO G. - Mating behaviour and competitiveness of gamma-irradiated Olive Fruit Flies. - Journal of Economic Entomology, Menasha.

B. Trials have been started irradiating Ceratitis capitata Wied. and Dacus oleae Gmel. by means of neutrons in each life stage in order to compare their biological effects with those obtained by using gamma-radiations.

Besides, comparison trials are in course with chemosterilants supplied by the Insect Chemosterilant Lab. USDA, Belthsville.

C. Studies on the gamma-radiation sensibility of Opius concolor Szépl. (Hymenoptera, Braconidae).

The insect has been irradiated in all life stages to determine lethal doses, sterilizing doses, the effect on adult life length and other physiological effects.

Full sterilization is achieved on adult males with 10 krad and decreases as doses are lessened (Tab. 2).

Table 2 - Effect of radiation of Opius concolor Szépl. males with different doses on the following generation.

DOSES (krad)	STERILITY (%)
1	18,35
2	66,26
4	78,93
6	89,79
8	99,31
10	100,00

It was found that breeding of irradiated males with normal females decreases the female number obtained in F_1 as doses are increased, while male number remains constant: on the basis of these data, owing to the peculiar pattern of sex determination in this species, sterilization level was evaluated taking into consideration only the obtained female number. Females are slightly more resistant than males to radiations and become sterile with very

Associato della Commissione:

Centro di Medicina Nucleare Università di Pisa

N. del contratto: 110-72-1 BIOI

Director: Prof. Luigi DONATO

Subject of Contract: Research and development of diagnostic technique and pathophysiological methods using in vivo and in vitro radioactive tracers.

In the year 1973 the studies were continued according to the fundamental address, common^{to} all projects and oriented towards the development of new methods for early diagnosis of disease state.

The studies in the field of radiochemistry have been markedly enhanced by the application of the concepts and methods of immunochromatography; the field of steroid radioimmunoassay is the one in which more significant progress has been made, ranging from the direct assay of aldosterone to the methods developed for gonadal steroids.

In vivo studies have continued in the three directions of the lung, kidney and coronary disease.

The most significant result in the lung field is the development and testing of a new agent for ventilation scan, which seems to overcome most of the limitations of previously available methods.

In the field of kidney disease further methodological advances have been made for the evaluation of the significance of renal involvement in hypertensive disease.

Finally in the coronary field the extensive application of the techniques for morphofunctional evaluation of myocardial perfusion, has been shown to be an extremely powerful tool for unveiling the mechanism for angina pectoris, particularly thanks to the further methodological improvement.

List of Publications

- A. Massaglia, U. Barbieri, Chyagrit Siri-Upatham: Preparation of 125-I-labelled steroid derivatives for radioimmunoassay. (I. A. E. A.) Int. J. of Appl. Radiation and Isotope, vol. 24, pp. 455-462, 1973.
- E. Rolleri, M. Hegesippe: Use of serum albumin microspheres as a reversible adsorbent for studying protein-small molecule interactions. Biochim. et Biophys. Acta, 295:429-437, 1973.
- U. Rosa: I principi del metodo radioimmunologico. LFC-SORIN.
- E. Rolleri, P. G. Novario, B. Pagliano: Automatic treatment of radioimmunoassay data. J. N. B. N. Vol. 17, n. 3 pp. 128-141 (July-Sept.) 1973.
- R. Malvano, C. Dotti, P. Grosso: 125-I-labelled cortisol-TME for competitive protein binding. Clinica Chimica Acta, 47, pp. 167-173, 1973.
- G. C. Zucchelli, R. Malvano, U. Rosa, A. Salvetti; Control of the enzyme systems in plasma renin activity measurement by angiotensin I radioimmunoassay. J. N. B. N. , n. 4 pp. 187-195 (Oct. -Dec.) 1973.
- R. Rosa, R. Malvano: Labelled compound for radioimmunoassay procedures. Reprint from: "Radiopharmaceuticals and labelled Compounds". I. A. E. A. , Vienna 1973.
- U. Rosa, R. Malvano, E. Rolleri: Critical factors in standardization of steroid radioimmunoassay. Proc. Workshop Conf. on Gonadotrophine and Gonadosterones. Ac. Press, London NY, in press.
- E. Rolleri, R. Malvano: Assessment and processing of RIA data. Proc. Workshop Conf. on Gonadotrophine and Gonadosterones. Ac. Press. , London NY, in press.
- R. Malvano, L. Troysi, G. Gandolfi, A. Attanasio, P. G. Crosigna: RIA of some gonadal steroid. Proc. Workshop Conf. on Gonadotrophine and Gonadosterones. Ac. Press. London NY, in press.
- R. Malvano, G. C. Zucchelli, D. Grosso Bartolini; Problems connected with the analytical plank in plasma renin activity and measurement by angiot. I RIA. Clin. Chim. Acta 1973, in press.

- R. Malvano, J. Queisada, E. Rolleri, C. Gandolfi, G. C. Zucchelli: Effects of methodological variables on insulin RIA. Clin. Chim. Acta 1973, in press.
- G. C. Zucchelli, C. Baccini: Il dosaggio radioimmunologico dell'attività reninica nel plasma: criteri di ottimizzazione e standardizzazione. Atti Congr. Patologia Clinica, Napoli, dicembre 1972.
- R. Malvano, E. Rolleri, U. Rosa: standardization and control of steroid RIA. Congress "Colloqui su Radioimmunosaggio e metodi connessi in medicina clinica e ricerca" 10-14 settembre 1973, Istanbul.
- E. Rolleri, R. Malvano, C. Gandolfi, U. Rosa: Effect of irreversible adsorbent on the dissociation of the antigen-antibody complexes". Hormone and Metab. Res., in press.
- R. Malvano, E. Rolleri, C. Gandolfi, U. Rosa: "Steroids RIA: properties of extradiol-antibody complex formed in homogeneous and heterogeneous phase". Hormone Metab. Res., in press.
- Bianchi C.; Measurement of the glomerular filtration rate. Progr. nucl. Med., vol. 2, pp. 21-53 (Karger, Basel and University Park Press, Baltimore 1972).
- Bianchi C., Palla R., Coli A., Giannotti P.: Sulla diagnosi funzionale ed etiologica mediante conteggio esterno delle nefropatie monolaterali con ipertensione arteriosa. Proceeding of the 3th National Congress of the Associazione Nazionale Medici Cardiologi Ospedalieri, Florence 1972, pp. 199-200.
- Bianchi C., Coli A., Palla R., Giannotti P.: The functional and etiological diagnosis of unilateral hypertensive kidney disease using external counting. Kidney International 3, 194, 1973.
- Bianchi C., Coli A., Palla R., Lo Moro A.: The reliability of ¹⁴⁰La-DTPA for the determination of glomerular filtration rate in man. J. Nucl. Biol. Med. 17, 158, 1973.
- R. Pasqualini, G. Plassio, M. Villa, A. M. Santolicandro, C. Guerini e C. Giuntini: Preparazione, marcatura con ^{99m}Tc e applicazione clinica di millimicrosfere di sieroalbumina con diametro 1-5 μ . XIII Congress Soc. Ital. Biol. e Med. Nucl., Pisa, novembre 1972. J. Nucl. Biol. Med., in press.

- Giuntini C., R. Pasqualini, G. Plassio, M. Villa: Préparation et marquage ^{99}Tc de microsferes de serum albumine da 0, 5-4/ μm pour études dynamiques et pour la scintigraphie pulmonaire.
Colloque sur le nouveautés en matière de produits radiopharmaceutiques et de composés marqués. Copenhague, 26-30 mars 1973, Mémoire I. A. E. A. -SM 171/62.
- C. Giuntini, A. M. Santolicandro, F. Fazio, C. Maugeri Saccà, E. Fornai, M. Villa, R. Pasqualini: Special lecture on new applications of radioisotopes in pulmonary physiology.
II Congress of the Italian Society Respiratory Physiopathology, Florence, 18-20 October 1973.
Rassegna di Fisiopatologia Respiratoria, in press.
- A. Maseri: La perfusione miocardica nella cardiopatia coronarica e nella angina pectoris.
Giornale Italiano di Cardiologia, vol. II, n. 2 (marzo-aprile) 1973.
- A. Maseri, A. Pesola, C. Contini, A. L'Abbate, L. Donato: Hémodynamique pulmonaire et coronarienne dans la phase aigue de l'infarctus du myocarde.
Arch. Mal. du Coeur, 66 année, n. 4 pp. 401-408, 1973.
- A. Maseri, A. L'Abbate, A. Pesola, C. Contini, P. Mancini: Effects of nitroglycerin on the derangements of regional myocardial perfusion occurring during angina.
Coronary Heart Disease, 2nd Intern. Symp. at Frankfurt, Georg Thieme Verlag, Stuttgart, 1973.
- C. Contini, L. Papi, A. Pesola, A. L'Abbate, G. Magini, T. D'Angelo, P. Cinacchi, A. Maseri, L. Donato: Tissue reaction to intracavitary electrodes. Effect on duration and efficiency of unipolar pacing in patients with A-V block.
The J. of Cardiov. Surgery, vol. 14 n. 3, pp. 282-290 (May-June) 1973.
- A. Maseri, A. Pesola, C. Contini, A. L'Abbate: Regional alterations of myocardial perfusion in angina pectoris.
VII Annual Meeting ESCI, 26/8. 4. 1973 (in press).
- A. Maseri: Myocardial blood flow in acute ischaemia.
Modern Trends in Cardiology, in press.
- A. Maseri, A. Pesola, A. L'Abbate, C. Contini, C. Michelassi and T. D'Angelo: Contribution of recirculation and fat diffusion to myocardial washout curves obtained by externa; counting in man. Stochastic versus monoexponential analysis.
Circulation Research, in press.

A. Maseri: Regional myocardial blood flow in humans.
Capitolo per il volume "Nuclear Cardiology" B. Pitt, H. W. Strauss
and A. E. Jones Jr., Eds. - Mosby - St. Louis.

A. Maseri: Correction of recirculation in regional blood flow studies
by residue detection. (Special comun.)
J. of Applied Physiol., in press.

C. Contini, T. D'Angelo, A. M. Ballestra, A. Leone, A. Maseri, L.
Donato: Resultats dans la therapie de l'arrêt cardiaque et respiratoi-
re, dommages d'organe et evolution clinique des surveçus.
Congr. Intern. Cardiologia, Madrid, in press.

: Results of project n° 1

Head of the project: prof. Umberto Rosa

Coworkers: Dr. Sergio Albera, Dr. Cesare Baccini, Dr. Paolo Cozzani, Dr. Renzo Malvano, Dr. Giancarlo Zucchelli

Title of the project: Development of radioimmunoassay methods for the measurement of proteic and non proteic antigens

Development of radioimmunoassay methods for the measurement of proteic and non proteic antigens

During 1973 the program has been mainly oriented to the development of antisera to aldosterone and to estrogens (estriol and estrone). In the case of aldosterone, the preparation of a conjugate at C₃ was carried out using a derivative which had been previously acetylated on the reactive positions of the C₁₇ side chain. The deblocking of the acetylated position after the coupling lead to a conjugate which was able to raise in rabbits very specific antisera to aldosterone /1, 2/. As for estrogens, estriol and estradiol activated at C₆, were coupled to BSA and used as antigens in rabbits. The antisera obtained were specificity enough to allow the direct measurement of the estrogens to be performed in plasma extracts /1, 2, 3/. These antisera were used in the subsequent part of the study.

Characterization of antisera to steroids. A simple technique based on the use of albumin microspheres as a reversible adsorbent of the unbound steroid, was developed to measure true binding parameters /4/. Using this technique, studies were carried out to investigate the effect of several parameters (pH, ionic strength, solvent composition etc.) on the antigen-antibody reaction. As a result of these studies methods for the direct assay of aldosterone, estriol and estradiol in plasma were set up. Moreover some general properties of the interaction of steroids with the antibody sites, such as the strong hydrophobic contribution, the inhibitory effect of some organic solvents or of ions, were put in evidence /1, 2/.

Standardization of radioimmunoassay procedures. Studies of the critical variables for radioimmunoassay were carried out, using as a model the assays of insulin and angiotensin I. The effects on the reliability of the measurement were assessed as regards the individual characteristics of antiserum and tracer preparations /5, 6/, the incubation modality /5, 6, 7/, the procedure of separation of free and bound antigen /5, 6, 8/, the non identity of samples and standards as for the protein content /5, 6/. Standardized methods for routine measurement of insulin and plasma renin activity were developed /5, 6, 9/. Computing programs for the automatic treatment of radioimmunoassay data were set up, taking into consideration the requirements of analyzing speed and simplicity set by routine measurements /10, 11/.

References:

- /1/ R. Malvano, E. Rolleri, U. Rosa: "Standardization and control of steroid radioimmunoassay" Proc. IAEA Symposium Radioimmunoassay and Related Procedures in Clinical Medicine and Research, Istanbul, Sept. 1973, SM-177/203 (invited paper), IAEA, Vienna (in press).
- /2/ U. Rosa, R. Malvano, E. Rolleri: "Critical factors in standardization of steroid radioimmunoassay" Proc. Workshop Conf. Gonadotropins and Gonadal Steroids, Milan, May 1973, Academic Press, London and N.Y. (in press).
- /3/ R. Malvano, L. Trojsi, C. Gandolfi, A. Attanasio, P.G. Crosignani: "Radioimmunoassay of some gonadal steroids" Proc. Workshop Conf. Gonadotropins and Gonadal Steroids, Milan, May 1973, Academic Press, London and N.Y. (in press).
- /4/ E. Rolleri, M. Hégésippe: "Use of serum albumin microspheres as a reversible adsorbent for studying protein-small molecules interactions" Biochim. Biophys. Acta 295, 429, 1973.
- /5/ R. Malvano, T. Quesada, E. Rolleri, C. Gandolfi, G.C. Zucchelli: "Effects of methodological variables on insulin radioimmunoassay" Clin. Chim. Acta (in press).
- /6/ R. Malvano, G.C. Zucchelli, D. Gasser, V. Bartolini: "Problems connected with the analytical blank in plasma renin activity measurement by angiotensin I radioimmunoassay" Clin. Chim. Acta (in press).
- /7/ R. Malvano, U. Rosa, G.C. Zucchelli: "Radioimmunoassay in non equilibrium conditions" XXI Coll. Protides Biol. Fluids, Brugge, April 1973.
- /8/ E. Rolleri, R. Malvano, C. Gandolfi, U. Rosa: "Effect of irreversible adsorbent on the dissociation of antigen-antibody complexes" Horm. Metab. Res. (in press).
- /9/ G.C. Zucchelli, R. Malvano, U. Rosa, A. Salvetti: "Control of the enzyme systems in plasma renin activity measurement by angiotensin I radioimmunoassay" J. Nucl. Biol. Med. 17, 187, 1973.
- /10/ E. Rolleri, P.G. Novario, B. Pagliano: "Automatic treatment of radioimmunoassay data" J. Nucl. Biol. Med. 17, 129, 1973.
- /11/ E. Rolleri, R. Malvano: "Assessment and processing of radioimmunoassay" Proc. Workshop Conf. Gonadotropins and Gonadal Steroids, Milan, May 1973, Academic Press, London and N.Y. (in press).

Results of project n° 2

Head of the project: prof. Umberto Rosa and Renzo Navalesi.

Coworkers: Dr. Renzo Malvano, Dr. Anilla Massaglia,
and Dr. Ermanno Rolleri

Title of the project: Studies on the properties of insolubilized antibodies

Studies on the properties of insolubilized antibodies

During 1973 the program has been oriented to the study of the coupling reactions for the preparation of IgG-Sepharose derivatives and of the effects associated with the insolubilization of IgG. The measurements of binding data and of the cross-reaction with related molecules were used to quantitate these effects. The estradiol-antiestradiol system was used as a model for the following reasons: - the availability of a high-quality antiserum /1/; - the responsiveness of the system estradiol-estrone-estriol as an index of specificity.

Comparison among different forms of solid-phase antibodies. The properties of the estradiol-antiestradiol complexes formed with either soluble or insolubilized antibodies (covalently linked to Sepharose or adsorbed onto plastic surfaces) were compared /2/. It was found that specificity is fully preserved in insolubilized antibodies, while the immunoreactivity is significantly reduced. These studies suggested that the effect of insolubilization can be minimized by controlling the parameters which govern the coupling reaction.

Some conclusions emerged from these studies: /3/

- a) the coupling position on the IgG molecule is of major importance in determining the efficiency of the reaction, as evaluated in terms of number of sites and of affinity.
 - b) the degree of packing (IgG molecules/unit mass of Sepharose) is highly effective in determining the total number of available sites.
- By optimizing the coupling conditions, the transition of the IgG molecule from liquid to solid phase can be carried out with high efficiency (> 90% in terms of immunoreactivity).

Antibodies entrapped in molecular cage. A different approach for preparation of solid-phase antibody was also attempted, always using estradiol antiserum. The antibody was entrapped in polyvinylpyrrolidone (PVP) by dissolving the IgG in an aqueous solution of PVP and cross-linking the polymer under γ -ray irradiation. The polymer, dried and grounded, was studied in comparison with the original properties of the soluble antibody. A significant decrease of the immunoreactive properties resulted (25% yield), while the specificity was essentially maintained.

References:

- /1/ R. Malvano, L. Trojsi, C. Gandolfi, A. Attanasio, P.G. Crosignani: "Radioimmunoassay of some gonadal steroids" Proc. Workshop Conf. Gonadotropins and Gonadal Steroids, Milan, May 1973, Academic Press, London and N.Y. (in press).

- /2/ A. Massaglia, E. Rolleri, U. Barbieri, U. Rosa:
"Fractionation of antibodies to testosterone" J. Clin. Endocr. Metab.
(in press).
- /3/ A. Massaglia, S. Comoglio, E. Rolleri, U. Rosa:
"An improved method for coupling immunogamma globulins to Sepharose"
Submitted to J. Clin. Endocr. Metab.

Results of project n° 3

Head of the project: prof. Umberto Rosa

Coworkers: Dr. Anilla Massaglia, Dr. Ermanno Rolleri,
Dr. U. Barbieri and Dr. S. Comoglio.

Title of the project: Fractionation of antisera by affinity
chromatography

Fractionation of antisera by affinity chromatography

During 1973 the program has been mainly oriented to optimize the conditions of preparation of adsorbent for affinity chromatography. Using testosterone as a model, the factors governing the adequacy of the adsorbent were studied (nature of the solid matrix, coupling reaction, elution conditions) /1/. Among the matrices considered, activated glass beads and Sepharose proved suitable as far as chemical yield and immunoreactive fraction of coupled derivatives was found to improve significantly the properties of the adsorbed. The stability of the immunoadsorbed was checked: in the experimental conditions used a lower release of the ligand resulted for the glass adsorbent, although also for Sepharose the release was still acceptable.

Fractionation of testosterone antiserum /2/. Aim of this work was /1/ to establish whether homogeneous classes of antibodies can be separated and /2/ to study the properties of each classes of antibody sites. A Sepharose-testosterone derivative was used as a chromatographic support. By stepwise elution with buffers at pH ranging from 5 to 3 and with a 10% dioxane-buffer mixture at pH 3, two well distinct and homogeneous antibody fractions with affinity constants 2.1×10^8 liters/mole and 6.5×10^8 liters/mole, were obtained; 67% of the applied antibody activity was recovered. The antibody fractions showed the same specificity for testosterone and dihydrotestosterone compared to the unfractionated antiserum, suggesting a substantial similarity of the binding sites. Studies on the properties of the two classes of binding sites are in progress.

References:

- /1/ S. Comoglio, A. Massaglia, U. Rosa: "Preparation of immunoadsorbents for affinity chromatography of testosterone antisera" in preparation.
- /2/ A. Massaglia, E. Rolleri, U. Barbieri, U. Rosa: "Fractionation of antibodies to testosterone" J. Clin. Endocr. Metab. (in press).

Results of project number 4

Head of the project and scientific coworkers:

Prof. Carlo Giuntini, Dr. Ferruccio Fazio, Dr. Anna Maria Santolicandro, Dr. Carmelo Maugeri Saccà

Title of the project: New applications of short lived radio isotopes to the quantitative evaluation of lung function.

Of the two lines of research projected for the year 1973 the one concerning the inhalation of microspheres labelled with $99m\text{-Tc}$ has progressed to such an extent that deserves a detailed description. Therefore, we shall confine to report on the application of this technique.

Study of the distribution of lung ventilation by microspheres aerosol.

Methods.

Microspheres inhalation. Microspheres are inhaled through an aerosol of the suspension using a nebulizer based on Venturi's principle. As pressure source a tank of compressed air is used. A suitable lead shielding is placed between the visual field of the collimator and any possible source of radioactivity outside the respiratory system of the patient. Through a mouthpiece the patient inspires the microspheres aerosol mixed to ambient air and exhales the expired air containing radioactive microspheres to an external exhaust.

The overall duration of the inhalation is of about 12-15 minutes and the average amount of radioactivity lost from the microspheres suspension in this period varies from 2 to 6 millicuries.

The patient is seated with his back leaning against the collimator surface of the gamma-camera. The collimator is of the diverging holes type and is placed in front of a crystal with an overall diameter of 11 inches. With this detecting device it is possible to include in one single field of vision both lungs even in people of large size. The only drawbacks are the relatively low efficiency of the system and some distortion of the image.

The radioactivity detected by the gamma-camera is simultaneously recorded on a digital printer, an analog recorder and a magnetic tape. Furthermore, following on a monitoring oscilloscope the sequence of the radioactive images, Polaroid scintiphotos are obtained at appropriate time intervals. This recording mode enables one to review by play-back all the events recorded during the study at a later time. Finally, it is possible to choose areas of interests from the overall area included in the sensitive field of the camera. This possibility allows one to study the regional distribution of the radioactive microspheres. An observation worthy to be mentioned is that the radioactivity builds up linearly in time throughout the pulmonary regions examined, during the period of the study. Likely, under these experimental conditions, the microspheres inhaled by the patient during the entire period of nebulization represent only a minor fraction of those left in the nebulizer.

Study of the diameter of the microspheres. As anticipated, following the process of labeling, the microspheres show a small but definite increment in their diameter from 2.05 to 2.37 microns. However, the relevant measure of the diameter of the microspheres is that taken at the exit of the nebulizer, i. e. where they begin to travel in the airways down to the last branching generations and the alveoli.

Therefore, the jet of the aerosolized microspheres suspension is collected on siliconized glasses and photographs of the microspheres are taken through the optical microscope using a reference scale and a magnification of 4,000 diameters. The microspheres are then counted according to their size and subdivided into classes of half micron each. The frequency of each class is plotted in the form of histogram. In over 30 of such counts totalling about 15,000 microspheres the average diameter has come out very close to 0.8 micron, i. e. one third of the average diameter of the microspheres originally put into the nebulizer.

During the nebulization process the microspheres do then undergo a very significant selection according to which only the smaller size microspheres of the original population get a chance to escape out of the nebulizer. This selecting mechanism depends likely on the particular shape of the nebulizer and does not depend on the pressure applied to the nebulizer that is responsible, on the other hand, for the volume of the aerosol produced.

Results.

Considering the results so far obtained in normal subjects, it is apparent that, with the inhalation of the microspheres, the radioactivity in the pulmonary fields is rather uniformly distributed from the very first minutes with respect to the peripheral and hilar regions. This observation is in agreement with the notion that only particles with diameter of about one micron are able to reach the alveoli.

These findings are in sharp contrast with all the previous results obtained with the aerosol of particles of larger sizes that show prevailing deposition of radioactivity along the bronchial ramifications especially near the hilum.

Results of project number 5

Head of the project and scientific coworkers:

Prof. Attilio Maseri, Dr. Carlo Contini, Dr. Antonio Pesola, Dr. Paolo Mancini, Dr. Anna Maria Ballestra, Dr. Rita Mimmo, Dr. Anna Maria Paci.

Title of the project: Development of the use of short lived radioisotopes in morphofunctional quantitative myocardial studies.

Alterations in myocardial perfusion in angina pectoris

Twenty-six regional myocardial perfusion studies were performed in 24 patients in a variety of conditions: normal subjects isolated stenosis of the anterior descending, or multiple stenosis of right and left coronary arteries before and after by-pass surgery. A Pho-Gamma III Nuclear Chicago scinticamera was used in conjunction with a HP2116B computer, capable of simultaneous recording of two isotopes.

The initial distribution and the washout of a diffusable gamma-emitting tracer and the myocardial distribution of an indicator both selectively injected into the coronaries were obtained in each study ^{133}Xe was used as a tracer, and $^{99\text{m}}\text{Tc}$ labelled human albumin microspheres were used as indicator, this combined approach made possible to evaluate blood flow changes in successive studies from initial distribution and washout slope of ^{133}Xe while keeping under control both patients displacement and build-up of gas into pericardial fat.

Studies were performed under basal conditions, pacing-induced angina, after intracoronary carbochromen, after nitroglycerin, and after relapse of the anginal attack due to pacing interruption or nitroglycerin administration, and finally by injecting Xe immediately prior to the beginning of pacing.

Results

In basal conditions no appreciable differences are seen in the initial distribution of either tracer or indicator between zones dependent from healthy or damaged vessels. Xenon and Technetium distribution are perfectly superposable.

Carbochromen and pacing increase Xe washout rate both in "healthy" and "ischaemic" areas. In the former ones the increase maybe four-to five times the basal rate, being less important but still significant in the latter.

During angina the initial tracer accumulation is markedly reduced in the areas perfused by damaged vessels. Nitroglycerin administration, when effective, an anginal pain brings back to basal conditions the initial distribution.

When pacing-induced angina occurs, the washout rate is slowed down in the same areas in which the initial distribution shows the appearance of accumulation defects.

This data underline the importance of regional myocardial blood changes in pathogenesis of angina, show that the increased flow in healthy areas does not necessarily entail a reduced perfusion in ischaemic areas, suggest the occurrence of an endocardial-epicardial redistribution of flow during angina, supply new data on the mechanism of action of drugs of large use in the treatment of ischaemic heart disease, and confirm the importance of functional factors (humoral or neurogenic) in acute coronary insufficiency.

Results of project number 6

Head of the project and scientific coworkers:

Prof. Claudio Bianchi, Prof. Vincent T. Andriole,
Dr. Antonio Coli, Dr. Roberto Palla, Dr. Mario
Bonadio

Title of the project: Radioisotopes techniques in the
morphological and functional study of the renal diseases
and in the etiological evaluation of hypertension.

The measurement of the filtration fraction of each kidney in the study
of hypertension.

In 15 hypertensive subjects (9 with renovascular hypertension, 3 with unilateral pyelonephritis, 3 with essential hypertension) the filtration fraction (FF) of each kidney has been determined by simultaneously measuring the glomerular filtration rate (GFR) and the effective renal plasma flow (ERPF) by means of ^{131}I -hypaque and ^{125}I -hippuran respectively. A marked difference was observed between most of the subjects with renovascular hypertension and those with either unilateral pyelonephritis or essential hypertension. In fact, in 6 of the 9 patients with renovascular hypertension the mean ratio between the FF of affected kidney and that of controlateral was 0.80 (range 0.71-0.89). In the remaining 3 cases a slight difference between the two sides was observed (range 0.94-0.97). On the contrary, in all patients with unilateral pyelonephritis FF of the affected and controlateral kidney was very similar. In these cases in fact the mean ratio between the two sides was 0.99 (range 0.98-1.00). Also in all cases with essential hypertension no difference in FF between the two sides was observed (mean ratio FF of the left kidney/FF of the right kidney=1.00; range 0.99-1.00).

The above reported results demonstrate a different qualitative impairment of renal function existing in renovascular hypertension as compared with unilateral pyelonephritis or essential hypertension. In the ischemic kidney, in fact, glomerular filtration is more involved

than tubular function. On this base the measurement of unilateral FF seems to be useful for the etiological diagnosis of unilateral hypertensive kidney diseases.

The influence of postural changes on renal function in nephroptosis.

The influence of postural changes on renal function was determined in 13 patients with nephroptosis and in 5 normal subjects by measuring the glomerular filtration rate (GFR) in the erect and supine positions by means of ^{131}I -hypaque and external counting (1). The results indicate that GFR was reduced in the erect position in 10 of 13 patients with nephroptosis whereas it was increased in the erect position in 4 of 5 patients without renal disease. In fact the change in posture (from supine to erect position) produced a significant reduction of GFR both in unilateral and bilateral nephroptosis (mean variations respectively -16% and -23%), as compared to the results obtained in normal subjects (mean variation +9%) (see Figure 1).

These observations indicate that patients with nephroptosis may have significant reductions in renal function when they assume an upright position, and suggest that GFR measurements in the supine and erect position in patients with nephroptosis can be helpful in evaluating this disease.

References

- (1) - Bianchi C. : Measurement of the Glomerular Filtration Rate, Progr. nucl. Med, vol. 2, pp. 21-53 (Karger, Basel and University Park Press, Baltimore 1972).

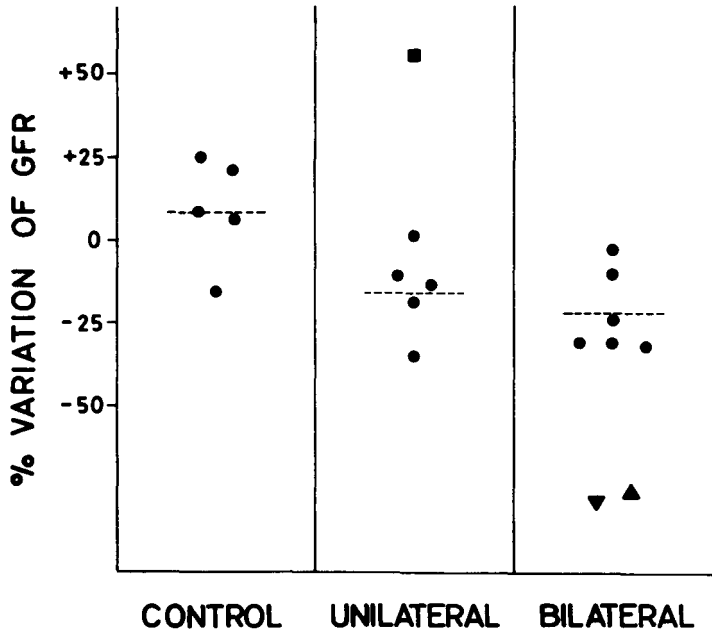

Figure 1 - Variation of GFR in the erect position in controls and patients with unilateral or bilateral nephroptosis. The broken line in each column represents the mean for each group.

Vertragspartner der Kommission:

Gesellschaft für Strahlen- und Umweltforschung,
Institut für Hämatologie

Nr. des Vertrages: 089-72-1 BIAD

Leiter der Forschungsgruppe: Priv.-Doz. Dr. Stefan Thierfelder

Allgemeines Thema des Vertrages:

Nuklearmedizinische Hämatologie (Proj. 4-7)

(Proj. 1-3 über Strahlenbiologische Hämatologie und Immunologie sind unter Kapitel III "Forschungstätigkeit Strahlenschutz" aufgeführt).

Allgemeine Darstellung der durchgeführten Arbeiten:

The projects of the research group in Munich continued their studies on the analysis and treatment of the consequences of radiation exposure. During 1973 the new facilities for experimentation on dogs of the GSF were taken over and studies on histocompatibility and conditioning treatments of dogs were started. In cooperation with Dr. Vriesendorp, TNO Rijswijk, the first 7 specificities of the MLC polymorphism were defined in the dog. Using fractionated cyclophosphamide several complete chimaeras could be achieved after DL-A compatible bone marrow transplantation. A meeting on the study of canine bone marrow transplantation was held in Ulm and half a year later in Munich where further cooperation between the EURATOM partners in Ulm, Rijswijk and Munich was planned along these lines.

Our observation that acute secondary disease can be suppressed in mice with anti-T-cell globulin was confirmed in large series. The T-cell antigen was localized with electronmicroscopy using antibodies labelled with peroxidase.

In man the frequency of the first MLC-specificity Pi could be established. The follow up study of radiation induced changes in the bone marrow of partially irradiated patients was continued. Our method for determining the time of DNA synthesis of individual bone marrow cells was applied to various types of anemias and helped to perform a comprehensive and detailed analysis of the kinetics of erythroblast proliferation in various diseases.

Ergebnisse des Projekts Nr. 4

Leiter des Projekts und wissenschaftliche Mitarbeiter:
S. Thierfelder, H. Rodt und M. Eulitz

Titel des Projekts:

Suppression of secondary disease with anti-T-cell
antisera in mice and dogs.

This project deals with the analysis and suppression of the immunological complications of bone marrow transplantation in lethally irradiated animals (secondary disease). Our approach consists in the manipulation of the marrow of the donor before it is injected into the recipient. We incubated the marrow with heterologous anti-brain globulin, which was purified from contaminating antibodies against stem cells. Immunoelectromicroscopy using peroxidase labelling demonstrated that the purified globulin reacted with T-cells only; B-cells or myeloid cells were not stained by the labelled antibody.

$0,5-5,0 \times 10^6$ spleen marrow cells of C57Bl/6 donors incubated with this antibody preparation suppressed secondary disease in lethally irradiated (C57Bl/6 x CBA) F_1 recipients. While donor cells without antibody killed all the recipients within 3 weeks, recipients of spleen marrow with antibody survived 300 days in good health. They had become complete chimaeras as to chromosomal analysis and showed a normal number of plaque forming cells. Comparative studies with heterologous anti-IgG or Fab-fragments of anti-brain globulin, anti-IgG or ALG showed none or little effect of these preparations underlining the importance of the Fc fragment for the inhibition of T-cells. Preliminary experiments in the rat model suggest a similar effect of anti-T-globulin. Further studies are planned to find out whether anti-T-cell globulin can be produced in dogs and are effective in canine secondary disease.

References see at the end of project No. 7 under Research on Applications in Medicine. 1. Nuclear Medicine.

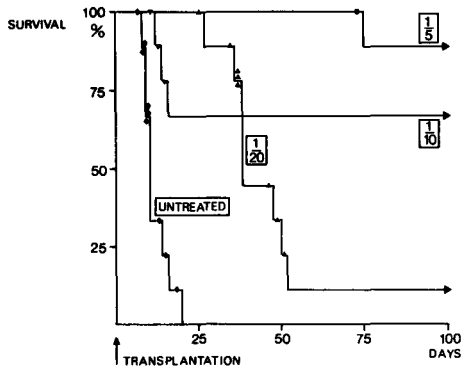

Survival of irradiated (C57B1/6 x CBA) F_1 chimaeras after transplantation of spleen marrow from C57B1/6 donors incubated with different concentrations of anti-T-cell globulin.

Ergebnisse des Projekts Nr. 5

Leiter des Projekts und wissenschaftliche Mitarbeiter:
S. Thierfelder, E. Thierfelder und H. Rodt

Titel des Projekts:

T-B-cell concentration of normal or athymic or bone marrow reconstituted mice.

Congenitally athymic nude mice lack T-cells and are valuable tools to study the effect of T-cell deprived marrow transplantation. The information concerning the absence of T-cells in nude mice stems from negative cytotoxic test with anti-theta-antisera, indicator systems with a sensitivity of about 10 %. Using spleen cells from homozygous nude donors a definite mortality was observed in (C57B1/6 x CBA)_F₁ recipients, which disappeared when the spleen cells were incubated with anti-T-cell globulin. This suggested a population of cells in nude mice with qualities of T-cells. Cytotoxic tests were evidently not suited for the study of low concentrations of T-cells. We therefore used quantitative complement fixation with a non-specific background well below 1 %. With this technique nude mice demonstrated about 1/10 of the T-cell specific complement fixation found in normal mice of the C57B1/6 and CBA strain. Similar results were obtained in quantitative immune autoradiography and in immunoelectron microscopy with ¹²⁵J labelled antibodies. Further studies with nude mice of different genetic background are planned. Whether the small number of T-cells comes from rudimentary parts of a thymusanlage or from maternal sources during pregnancy or from other organs is open to speculation.

Ergebnisse des Projekts Nr. 6

Leiter des Projekts und wissenschaftliche Mitarbeiter:
PD Dr. P. Dörmer, Dr. W. Brinkmann und F. Hegemann

Titel des Projekts:

Erythropoiesis and kinetics of erythroblasts in
anemias and aplasias in man.

A new method has been developed in this project for determining the time of DNA synthesis of individual bone-marrow cells identifiable according to morphological criteria. This method was dealt with in the last project report. It has now been applied to studies of human erythroblasts in various types of anemias. The birth rate in the various erythroblast compartments was calculated from the pertinent time of DNA synthesis and the ^3H -TdR labeling index. From the birth rate values, it was possible to infer the flux of erythroblasts through the compartments. This in turn provided the possibility of performing a comprehensive and detailed analysis of the kinetics of erythroblast proliferation in various diseases.

Proliferative activity was found to vary considerably with the type of anemia under investigation. In a case of acute hemolysis an increase in the proliferative activity of individual cells to twice the normal rate was seen. Conversely, a normal activity of the individual cells was established in cases of chronic hemolytic and bleeding anemia. Compensation of the anemia in these cases is effected predominantly by an enlargement of the erythropoietic matrix. In iron deficiency anemia and anemias caused by infiltrating bone-marrow diseases, the proliferative activity per cell is reduced. This reduction becomes the more pronounced the further an erythroblast proceeds in differentiation. Ineffective erythropoiesis caused by intramedullary cell-death was seen in a case of acute immune-hemolytic anemia and in cases of pernicious and acquired refractory anemia.

The results obtained so far in man have been included in a monograph by P. DÖRMER: "Kinetics of erythropoietic cell proliferation in normal and anemic man. A New approach using quantitative ¹⁴C-autoradiography." G. Fischer, Stuttgart 1973. As the next goal for 1974 a detailed analysis of the various types of pancytopenias in man is planned.

Ergebnisse des Projekts Nr. 7

Leiter des Projekts und wissenschaftliche Mitarbeiter:
W. Mempel, H. Grosse-Wilde, B. Netzel und S. Thierfelder

Titel des Projekts:

Tissue typing for bone marrow transplantation: Definition of MLC-alleles in men and dogs.

The goal of this project is the definition of a polymorphism which can only be tested in lymphocyte culture tests. After the establishment of the first MLC-specificity Pi in its homozygous form in man, the frequency of Pi was looked for in an unrelated population. A clear disequilibrium linkage in favor of HL-A-3-7-MLC-Pi was found. A further specificity linked to HL-A-3-W5 could be defined. A program for finding further specificities with heterozygous cells was set up. In analogy to humans 7 MLC-types could be defined in dogs. In cooperation with Dr. Vriesendorp from TNO Rijswijk 2 colonies of beagles and 1 colony of mongrels were tested. About 60 % of the haplotypes could already be defined, which indicates a restricted polymorphism in the MLC-system of these animals.

PUBLICATIONS APPEARED IN 1973

Albert, E.D., W. Mempel and H. Grosse-Wilde:
Linkage disequilibrium between HL-A and MLC.
Ztschr. f. Immunitätsforsch. 144, 434 (1973)

Bau, J. and S. Thierfelder:
Antilymphocytic antibodies and marrow transplantation.
I. The effect of antilymphocyte serum on xenogeneic
engraftment.
Transpl. 15, 564 (1973)

Burkhardt, R.:
Sternalpunktion oder Myelotomie? Fortschritte zytolo-
gischer und histologischer Knochenmarksdiagnostik.
Dtsch. Ärztebl. - Ärztl. Mitt. 70, 963 (1973)

Dörmer, P.:
Kinetics of proliferation in normal hemopoietic and
leukemic cells.
In E. Gerlach, K. Moser, E. Deutsch, W. Wilmanns (eds.),
Erythrocytes, thrombocytes, leukocytes, p. 356-361.
G. Thieme, Stuttgart (1973)

Dörmer, P.:
Quantitative autoradiography at the cellular level.
In V. Neuhoff (ed.), Micromethods in molecular biology,
p. 348-393. Springer-Verlag Berlin, Heidelberg, New York
(1973)

Dörmer, P.:
Die Variabilität der DNS-Synthesedauer einzelner Zellen:
Methodik und Auswirkung auf das therapeutische Konzept.
In G.P. Wüst (Hrsg.), Aktuelle Probleme der Therapie
maligner Tumoren, S. 160-177. G. Thieme, Stuttgart (1973)

Dörmer, P.:

Erythropoietic cell proliferation kinetics in normal and anemic man. A new approach using quantitative ¹⁴C-auto-radiography.

Monographie der Reihe: Progress in Histochemistry and Cytochemistry. G. Fischer, Stuttgart (1973)

Götze, D., R.A. Reisfeld and J. Klein:

Antibody against Ir-Region controlled antigen in mice. Naturwissensch. 60, 355 (1973)

Götze, D., R.A. Reisfeld and J. Klein:

Serologic evidence for antigens controlled by the Ir-region in mice.

J. exp. Med. 138, 1003 (1973)

Grosse-Wilde, H., W. Mempel, E. Albert, G. Rosenthal and S. Scholz:

MLC-reactions in families with special HL-A constellations.

Ztschr. f. Immunitätsforschung 144, 432 (1973)

Mempel, W., H. Grosse-Wilde, E.D. Albert and S. Thierfelder:

Atypical MLC-reactions in HL-A typed related and unrelated pairs.

Transpl. Proc. V, 1, 401 (1973)

Mempel, W., H. Grosse-Wilde and E.D. Albert:

MLC-reactions between HL-A typed unrelated persons.

Ztschr. f. Immunitätsforschg. 144, 433 (1973)

Rodt, H., S. Thierfelder und M. Eulitz:

Die Wirkung von heterologem Anti-Hirn-Serum auf T-Zellen bei akuter Sekundärkrankheit in Mäusen.

Ztschr. f. Immunitätsforschg. 145, 29 (1973)

Thierfelder, S., H. Rodt and M. Eulitz:

Suppression of acute secondary disease in mice by heterologous anti-brain-serum.

Exp. Hematol. 1, 78 (1973)

NEUTRONENDOSIMETRIE

NEUTRON DOSIMETRY

DOSIMETRIE DES NEUTRONS

Weitere Forschungsarbeiten zu diesem Thema werden auch in folgenden Jahresberichten beschrieben:

Further research work on these subjects will also be described in the following annual reports:

D'autres travaux sur ce thème de recherche sont également décrits dans les rapports annuels suivants:

094-BIAN ITAL, Wageningen (De Zeeuw)

101-BIOC Dosimetry Group

Biology Group Ispra

Vertrag Nr.: 113 BIOC

Leiter der Forschungsgruppe: Dr. Georg Burger

Allgemeines Thema des Vertrages: Die Berechnung und Messung von Energie-Dosis und Neutronenspektren innerhalb eines biologischen Objektes im Hinblick auf die Therapie mit schnellen Neutronen

The program is concerned with the determination of the biologically effective neutron dose inside human phantoms. It includes neutron and gamma deep-penetration calculations and measurements with various detectors.

One point of the experimental investigations was the participation at the International Neutron Dosimetry Intercomparison which was organized by the ICRU and the CEC in the Brookhaven National Laboratory, N.Y. Similar experiments were carried out at the AN400 and K 3000 High Voltage accelerators of the GSF, Neuherberg. For the evaluation of dose from the ionization chamber data a computer program was established. The calculations of neutron- and γ -radiation field in the interior and surrounding of phantoms were continued. The production and transport of secondary particles and γ -rays in the phantom was investigated. Three types of source-phantom arrangements were of special interest:

- 1.) Neutron sources, collimators and phantoms which are reasonable in neutron therapy
- 2.) Neutron fields which may occur in radiation protection
- 3.) Standard arrangements for intercomparison purposes

Ergebnisse des Projekts

Leiter des Projekts und wissenschaftliche Mitarbeiter:

G. Burger, E. Maier, F. Grünauer

Titel des Projekts: Die Berechnung und Messung von Energie-Dosis und Neutronenspektren innerhalb eines biologischen Objektes im Hinblick auf die Therapie mit schnellen Neutronen

In 1973 ICRU and CEC organized an International Neutron Dosimetry Intercomparison at the Radiological Research Accelerator Facility (RARAF) of the Brookhaven National Laboratory, N.Y.. Various groups, which perform absolute fast neutron dosimetry in radiotherapy or radiobiology, participated in this intercomparison. Its purpose was to identify the most accurate method of fast neutron dosimetry. The monoenergetic neutrons were generated by the 4 MV Van-de-Graaff accelerator of RARAF.

During this intercomparison we measured the kerma-rates of a ^{252}Cf -source and of monoenergetic neutrons with energies of 15.4 MeV, 5.5 MeV, 2.1 MeV and 0.67 MeV at a distance of 30 cm from the target. For 15.4 MeV and 5.5 MeV we measured also the dose rate at 5 cm, 10 cm and 20 cm depth of a cubical phantom with an side length of 30 cm. In preparation to this intercomparison we built up a ionisation chamber system with a gasflow system and an electrometer whose output was fed into a digital voltmeter. We used a TE-chamber and a C-chamber of EG&G, calibrated by a Siemens-Dosimeter which itself was calibrated at the PTB Braunschweig. With this system measurements were made at the accelerators in Neuherberg with the same neutron energies as used in Brookhaven. We studied the saturation characteristics at the different neutron energies and at different dose rates. By measuring the distance dependency it was possible to determine the effective center of the chambers. The influence of the wall thickness on the measured charge was investigated by adjusting caps of different thicknesses. The depth dose distribution in a similar phantom as used at RARAF was determined for 15.4 MeV and 5.5 MeV neutrons.

Our transport calculations dealt mainly with the determination of the neutron- and gamma-field in the interior of a phantom for a series of external sources and different geometries, which are of interest in practical dosimetry. The spatial dose distribution and the components of the dose which arise from the different secondary particles and the gamma-rays were calculated from the spectra neutron flux density inside the phantom. We need these results for the following purposes:

- 1) The interpretation of the readings of dosimeters like ionisation chambers and Rossi-type proportional counters needs to some degree the knowledge of the spectrum, e.g., in order to calculate the tissue-dose from the carbon chamber reading, it is necessary to know the kerma-ratio of carbon to tissue. This ratio is strongly depending on the neutron energy distribution, i.e. this ratio is a function of depth.
- 2) The computation method and the cross sections used have to be checked by experimental results and vice versa.

3) Until now there do not exist experimental devices, which measure the neutron- and gamma-spectra within the total energy range of interest. The knowledge of the spectra is necessary to understand the mechanism of radiation damage.

All calculations were performed with a modified version of the two-dimensional multigroup transport code DOT-2. The cross sections and fluence to kerma factors were taken from the data collections DLC-9 and DLC-11 (RSIC, Oak Ridge). As an example Fig. 1 shows the calculated depth dose distributions in a water phantom which is irradiated by a neutron point source at a distance of 20 cm to the front of the phantom; no collimation is applied. The agreement of the results of the calculation and the experiment is very good concerning the neutron component. The gamma-values differ considerably. This is mainly due to the unknown gamma-source strength of the neutron source and the gamma stray-field. Both were not considered in the calculations.

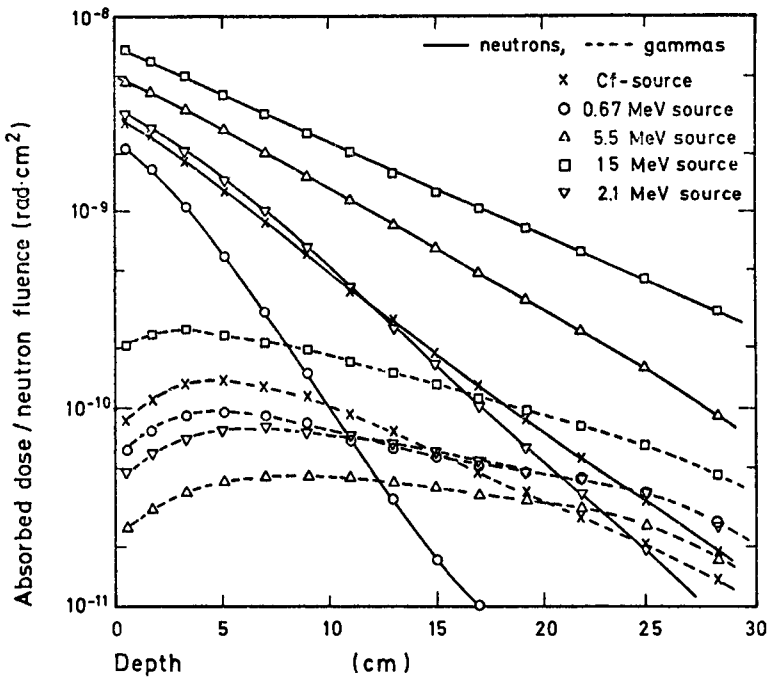

Fig. 1: Calculated depth dose curves for a 30 x 30 x 30 cm³ water phantom; source-to-front-distance: 20 cm; no collimation; normalized to 1 cm⁻² incident neutron fluence at the axis.

Vertragspartner der Kommission:
Gesellschaft für Strahlen- und Umweltforschung
München

Nr. des Vertrages: 113-72-1 BIOC

Leiter der Forschungsgruppe:
Prof.Dr.W.Pohlit

Allgemeines Thema des Vertrages:
Calculation and Measurement of Absorbed Dose
and Neutron Spectra inside a Biological Object
with Reference to Fast Neutron Radiotherapy

Back scattering factors of neutron doses with ionization chambers have been determined. The investigations will be continued. An ionization chamber arrangement for measuring the average energy expenditure of heavy ions to produce an ion pair in several gases has been built and has been connected to a Brown Boveri 600 kV accelerator.

Ergebnisse des Projektes

Nr. 1

Leiter des Projektes und wissenschaftliche

Mitarbeiter: Dr.H.Kühn

Titel des Projektes:

Determination of back scattering factors
of neutrons

The accuracy of neutron dose determinations is influenced by materials in the vicinity of a dosimeter. The influence of scattered neutrons on dose determinations has been investigated by placing a polyethylene phantom behind an ionization chamber at a chosen distance. The phantom consisted of 6 polyethylene disks. The thickness of each disk has been 5 cm. The surface area of the phantom has been 60 cm x 60 cm. The whole arrangement has been irradiated with 15 MeV neutrons varying the thickness of the phantom. According to the back scattered neutrons the neutron dose increased with increasing phantom thickness until a thickness of 15 cm is reached. For greater thicknesses than 15 cm the dose remained constant. For example the maximum dose increase has been 7.5% at a constant distance of 2.5 cm between the ionization chamber and the phantom surface. For dose measurements at distances greater than 2.5 cm cylindrical ionization chambers are used. For dose determinations at distances less than 2.5 cm an extrapolation chamber is under construction. It is intended to compare the dose determinations with fluence measurements applying small fission chambers of different threshold energies.

At the moment only a U-238 fission chamber has been used. A comparison between the results of dose measurements and fluence measurements have not yet been made since the data are too scarce at this moment.

References

- Kühn,H. "Aspects in practical neutron dosimetry with ionization chambers",Biophysik 10,229 (1973).
- Kühn,H. "Dosimetry of fast neutrons for radiotherapy at the DKFZ cyclotron in Heidelberg",Discussion Paper,2nd Meeting on Fundamental and Practical Aspects of the Application of Fast Neutrons in Clinical Radiotherapy,Den Haag,October 3 - 5, 1973.

Ergebnisse des Projektes

Nr. 2

Leiter des Projektes und wissenschaftliche
Mitarbeiter: Dr.H.Kühn, Dipl.-Phys.T.Werba

Titel des Projektes:

Determination of the average energy expenditure to produce an ion pair in different gases for heavy ions

For the determination of the absorbed dose and of the kerma of neutrons with ionization chambers a knowledge of the value of the average energy expenditure W to produce an ion pair in several gases for different heavy ions is necessary. Especially there is a great lack of data regarding tissue equivalent gas irradiated with protons and heavier ions in the low energy range. At a 600-kV-BBC accelerator an experimental arrangement of an ionization chamber (diameter 18 cm, length 50 cm) has been built.

The value of the gas pressure (15 Torr) which can be regulated is chosen in such a manner that the entering ions are stopped within the chamber. The radius of the chamber has been chosen by regarding the range of the produced secondary electrons with maximum energy at a gas pressure of 15 Torr.

At the entrance of the ionization chamber a special ring diaphragma has been mounted to avoid secondary electron emission of the entrance funnel into the ionization chamber. The entrance beam is monitored by a rotating Faraday cup. The current at this Faraday cup has been compared with the current measured at a second Faraday cup mounted at the exit of the chamber and providing high vacuum in the ionization chamber.

Within the experimental error the dependence between the monitor current and the beam current is linear. The diameter of the beam entering the ionization chamber is about 0.02 cm. Usually beam currents of about 10^{-10} A are employed. At a polarizing voltage of about 200 V and a gas pressure of 15 Torr the saturation conditions of the ionization chamber are reached. The chamber itself is connected to the high vacuum of the beam guide of a 600 kV accelerator by a double pressure stage which has been calculated after a paper of Schuhmacher (Optik 10, 116 (1953)) and applying the characteristic data of the vacuum pumps used. At the moment only some preliminary experiments have been performed showing that the device is working well.

Contractor: Medical Research Council

Contract No. : 113 - 72 - 1B10C

Head of research team : D.D. Vonberg

General subject of Contract : CORRELATION OF

PHYSICAL AND BIOLOGICALLY EFFECTIVE DOSE OF FAST NEUTRONS

Mammalian cells have been exposed to the fast neutron beam from the MRC cyclotron at various depths in a phantom and with the phantom removed. The cells were in suspension and were bubbled with air or nitrogen during irradiation. The results have been correlated with measurements of absorbed dose at the depths used.

Other cells have been exposed to the beam with and without secondary charged particle equilibrium, again in the presence and absence of oxygen. This will enable us to obtain information on the separate radiobiological properties of the recoil proton and heavy recoil components of the dose.

Results of Project No. : 1

Head of Project and scientific staff: D.K. Bewley
R.J. Berry

Title of Project: MEASUREMENT OF BIOLOGICALLY
EFFECTIVE DOSE OF FAST NEUTRONS.

The work reported last year has been extended by two further experiments: a) cells were exposed to 8 MV X rays at 8.7 cm deep in the phantom and with the phantom removed, and b) cells were exposed to neutrons when half-sunk at the surface of the phantom. The latter situation extends the set of experiments detailed in last year's report. The former is designed as a control, to investigate all possibilities of error in the results. There should be no difference in RBE in and out of a phantom using X rays and the experiment will show whether any factor other than the quality of the neutron beam is producing the results observed. The results of these two experiments await completion of the biological assays.

Results of Project No. 2

Head of Project and scientific staff: D.K. Bewley
N.J. McNally

Title of Project: EFFECT OF SECONDARY CHARGED-PARTICLE
SPECTRUM ON BIOLOGICAL RESPONSE.

We have supplemented the biological experiments reported last year by calculating and measuring the distribution of dose in the transition zone. When the measurements (with an ionization chamber having a very thin front wall) were extrapolated to the surface good agreement was found with calculated values of partial dose. The dose right on the surface, which is due only to alpha particles and heavy recoils, is about 20% of the Kerma but accounts for 40% of the biological effect in charged-particle equilibrium. The RBE of this densely ionizing component is about 7, compared to an RBE of 3 for the recoil proton component. We conclude that the reduced OER shown by fast neutrons is due entirely to the densely ionizing component of the dose, whereas the rise in RBE also arises in part from the recoil protons.

Radiobiological Institute TNO, Rijswijk (ZH), The Netherlands

Contract No. 113-72-1 BIOC

J.J. Broerse

Calculation and measurement of absorbed dose and neutron spectra inside a biological object with reference to fast neutron radiotherapy

Quantitative studies of neutron interactions and penetration in anthropomorphic phantoms have been performed in view of the clinical application of 15 MeV neutrons. The dosimetry studies have been continued, and were primarily directed to the measurement of the gamma contamination of the fast neutron fields. Information on beam profile and depth dose is presented and discussed in relation to the experimental data obtained for conditions of similar geometry.

Results of project No. 1

J.J. Broerse and J.E. Broers-Challiss

Measurements of gamma contamination of fast neutron fields

Over the past year the studies on the response of pulmonary metastases in patients are continued; an interim report (Van Peperzeel et al., 1974) on the clinical results has been presented at the 2nd meeting on Fundamental and Practical Aspects of the Application of Fast Neutrons in Clinical Radiotherapy, which was held at The Hague from October 3-5, 1973. The dosimetry studies connected with this clinical program have primarily been directed to the measurement of the various radiation components of the collimated 15 MeV neutron beam. Interactions of neutrons with the collimator materials and the irradiated tissue give rise to gamma rays which can contribute significantly to the absorbed dose. In view of the difference in effectiveness of the neutron and the gamma component of the radiation field, it is of great importance to determine the relative contributions of the two components, so that a correlation can be made between the patient data and the RBE studies of biological systems for fast neutrons which have been carried out using an uncollimated neutron beam.

The problem of estimating the gamma contamination of the neutron field has been approached by two different methods. Firstly, a combination of two ionization chambers was used, one of which is relatively insensitive to neutrons. The response of a spherical tissue-equivalent ionization chamber has been compared to that of an argon-flushed Magnox chamber of equal dimensions which has a small neutron sensitivity indicated by the coefficient, k . This coefficient, k , is dependent on the neutron energy and was estimated for the argon-flushed Magnox chamber to be 0.14 for 15 MeV neutrons. The second approach concerns the use of a suitably shielded Geiger-Müller counter as a gamma-ray dosimeter as developed by Wagner and Hurst (1961). The detector used was a Philips micro GM counter fitted with a special shield consisting of lead and tin, which provides a response independent of energy for photon energies between 200 keV and 1.25 MeV. An additional ${}^6\text{Li}$ shield has been applied which appreciably lowers the response to thermal neutrons.

Figure 1 shows the beam profile results at a depth of 9 cm plus the contribution of the gamma dose at this depth as determined by the two methods

described above. The contaminating gamma dose at the beam centre amounts to approximately 8% of the total dose (neutron plus gamma dose) at the same position; the gamma dose values at the other positions are expressed as a percentage of the total dose at that position. The relative gamma dose contribution increases with lateral distance from the beam axis, being approximately 40% of the total dose at a 12.5 cm lateral distance.

An evaluation of the gamma dose expressed as a function of depth in the phantom along the centre axis is given in figure 2, where the gamma dose is expressed as a percentage of the total dose at each depth. The results obtained with the ionization chambers and the GM counter are slightly different from the results of other investigators, which indicate higher values of the gamma component. In particular, the present experiments indicate an average gamma dose of 9.5% of the total dose at 5 cm depth in comparison to 17% as reported by Greene (1972), whilst at 20 cm depth, our results indicate an average gamma dose of 13% of the total dose as compared to 19% as obtained by Bewley (1971) and by Kühn and Müller (1972).

As mentioned earlier the gamma dose measurements, using the set of two ionization chambers, were evaluated by applying a k factor of 0.14 for the argon-flushed Magnox chamber, which is the value estimated for a neutron energy of 15 MeV. A decrease in the neutron energy will introduce a decrease in the k factor; consequently, for measurements outside the beam, or at greater depths in the phantom, the two-chamber method might underestimate the gamma dose. This would provide an explanation for the fact that, in figures 1 and 2, the measurements of the gamma dose with the GM counter are generally higher than those measured by the two-chamber method.

Bewley, D.K., *Europ.J.Cancer*, 7, 99 (1971).

Greene, D., *Brit.J.Radiol.Suppl.*, 11, 89 (1972).

Kühn, H. and Müller, A., In: *Proc.Int.Symp.Neutron Dosimetry in Biology and Medicine*, Commission of the European Communities, Luxembourg, EUR 4896, p. 211 (1972).

Peperzeel, H.A. van, Breur, K., Broerse, J.J. and Barendsen, G.W., *Europ.J. Cancer*, (1974), in press.

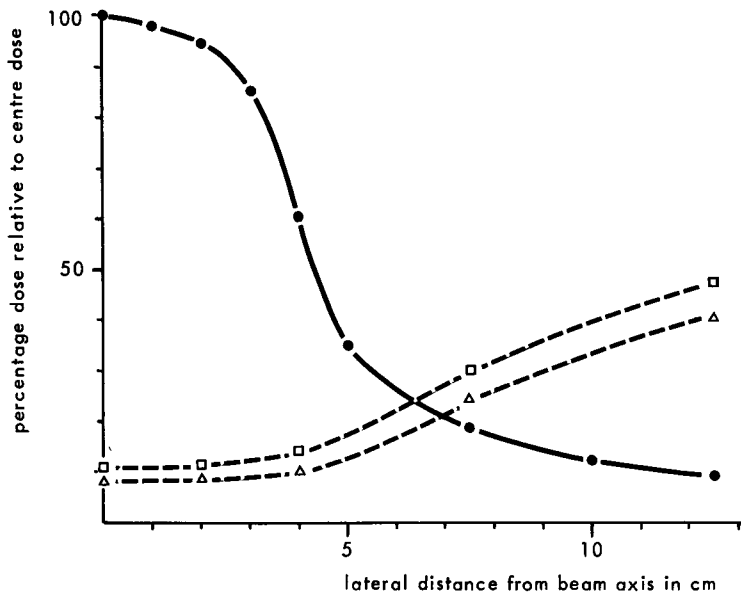

Figure 1. Beam profile curves in a tissue-equivalent liquid phantom. The measurements were carried out for a collimated 15 MeV neutron beam (TSD 45 cm, field size 6 x 8 cm) at a depth of 9.5 cm. The total dose was measured with a tissue-equivalent ionization chamber (●) whilst the gamma dose was determined with paired ionization chambers (Δ) and Geiger-Müller counters (□).

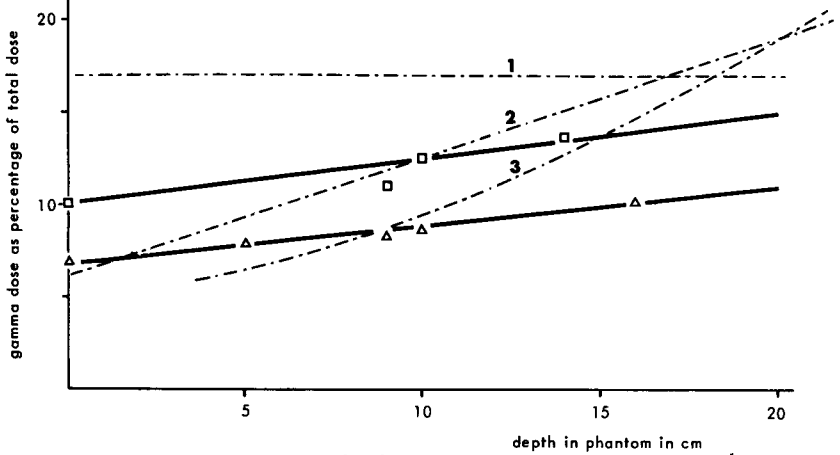

Figure 2. Dose due to gamma rays as a percentage of total dose for central axis depth in tissue-equivalent phantoms. The curves pertain to the following irradiation conditions: 15 MeV neutrons, TSD 45 cm, field size 6 x 8 cm; ionization chambers (Δ) and Geiger-Müller counters (□). Curve 1: Greene (1972), 14 MeV neutrons, TSD 55 cm, field size 10 x 10 cm. Curve 2: Bewley (1971), 8 MeV neutrons, TSD 75 cm, field size 14 x 14 cm. Curve 3: Kühn and Müller (1972), 14 MeV neutrons, TSD 106 cm, field size 13 cm radius.

Contractor: GSF - Projektgruppe Neuherberg
- Projektgruppe Frankfurt
MRC Cyclotron Unit
TNO Radiobiological Institute
ICRU

Contract No.: 113-72-1 BIOC

General Subject: Neutron Dosimetry Intercomparison Project

Heads of Project: D.K. BEWLEY, J.J. BHOERSE, G. BURGER,
W. POHLIT, H.O. WYCKOFF.

The Neutron Dosimetry Intercomparison Project will be carried out in two steps: first by the ICRU, second in the European Communities.

1. ICRU Intercomparison

The laboratory intercomparisons were completed in 1973. The experimental results are to be analyzed in spring 1974 in order to permit the publication of a final report during 1974.

2. European Neutron Dosimetry Intercomparison Project (ENDIP)

First steps in the preparation of this project have been taken in 1973 which will allow to invite in 1974 European laboratories to participate in the ENDIP. The project is largely dependent on results and experience to come out from the preceding ICRU intercomparison.

VI.

KOORDINIERUNGSTÄTIGKEIT

COORDINATION

ACTIVITES DE COORDINATION

VI. COORDINATION

Since the beginning of the programme "Biology - Health Protection" in 1960, coordination of research has always been accomplished by the Commission and its various contractual partners. A detailed scheme of the different levels of coordination, from the formulation of programme objectives to the implementation of joint projects, has already been published.

One important tool is the "Study Groups"; those which held meetings in 1973 are listed in part A. of this chapter. Although they have different scientific objectives and different aims and working methods, one feature is common to them all, namely that they bring together scientists from a wide variety of national laboratories and the Commission in free and open discussions, exchanges of views and information, and that they create contacts between European laboratories and thereby foster meaningful and continuing cooperation.

Part B. lists the meetings which the Commission has organized itself or actively supported, within the limits of its financial resources. It is evident from the worldwide resonance that these meetings have encountered, that they play an encouraging and stimulating role for the European scientific community.

* Annual Report 1972 "Biology - Health Protection", EUR 4864, chapter "Coordination", pages 747-751.

The Health Protection Directorate also organizes meetings of experts whose work has both the effect of coordinating and stimulating the research in the Commission's programme "Biology - Health Protection", especially with a view to practical measures for promoting radiation protection. Part C. lists these groups, particularly the Group of Experts on "Basic Safety Standards" mentioned in Article 31 of the Euratom Treaty.

A.

Meetings of

Study Groups in 1973

Study Group "Hematology and Immunology"

Munich, 8 March 1973,
11 participants from 5 countries and the Commission.

Principal subjects:

Coordination of the Euratom contracts dealing with hematology and immunology.

Collaboration to be intensified in the field of bone marrow or peripheral blood transplantation in dogs and the corresponding genetical implications.

Study Group "Thermoluminescence Dosemeters"

Luxembourg, 29-30 March 1973,
13 participants.

Principal subject:

Preparation of technical recommendations for the use of thermoluminescence in personnel dosimetry.

Study Group "Thorotrast"

Heidelberg, 5 April 1973,
15 participants.

Principal subject:

Coordination of papers to be presented at the Third International Meeting on the toxicity of thorotrast, Copenhagen, 25-27 April 1973.

Study Group "Soil Physics, Soil-Plant Relations and Reduced Tillage"

Brussels, 6 April 1973,
18 participants from 7 countries and the Commission.

Principal subjects:

Soil physical and chemical conditions, and root development.

Special fertilizer problems.

Weed and disease control.

Crop residue management.

Agronomical aspects and instrumentation.

Study Group "Plant Cell Culture"

Brussels, 25 April 1973,
16 participants from 5 countries and the Commission.

Principal subject:

Utilization of plant cell and tissue cultures in radiobiology and radiogenetics.

Study Group "Self- and Cross-Incompatibility in Higher Plants"

Brussels, 26 April 1973,
21 participants from 4 countries and the Commission.

Principal subjects:

The aim of the meeting was to allow a presentation of the results and programmes of leading european experts working in the field of self and unilateral incompatibility.

Contractants and non-contractants of the Commission participated in the meeting which covered the following subjects:

- the genetics of self- and cross-incompatibility
 - mutation spectrum at the S-locus
 - biochemistry of incompatibility reactions
 - ultrastructure of self- and cross-incompatibility
 - the modification of breeding systems.
-

Study Group "Personnel Dosimetry"

Luxembourg, 7 May 1973
29 participants.

Principal subject:

Discussion of the results of the comparison programme of neutron dosimetry.

Study Group "Radioentomology"

Padua, 29-30 May 1973,
16 participants from 3 countries and the Commission.

Principal subject:

Radioentomological problems in relation with the sterile-male and the translocation techniques.

Study Group "Primary Effects of Radiation on Nucleic Acids"

Grenoble, 14-15 June 1973,
17 participants from 7 countries and the Commission.

Principal subjects:

Studies of radical formation; properties and behaviour of radicals in nucleic acids in solid and liquid state and in complexes of nucleic acids and dyes or amino acids.

Study Group "Dosimetry"

Rome, 14-15 June 1973,
19 participants from 5 countries and the Commission.

Principal subjects:

Energy transfer in biological material and in model substances.

The evaluation of the biological effectiveness of different types of radiations.

Radiation effects in condensed matter and its application.

Study Group "Control and the Monitoring of Radioactive Pollution of Water, Air and Foodstuffs in the Vicinity of Nuclear Power Stations"

Luxembourg, 26-28 June 1973,
35 participants.

Principal subject:

Discussion of the final report "Monitoring and control of radioactivity in the vicinity of nuclear installations".

Study Group "Thermoluminescence Dosemeter"

Luxembourg, 20 September 1973,
11 participants.

Principal subject:

Preparation of technical recommendations for the use of thermoluminescence in personnel dosimetry.

Study Group "Personnel Dosimetry"

Luxembourg, 1 October 1973,
20 participants.

Principal subjects:

Report of the members of the contract 065-72-1 PST C on the work carried out in 1973.

Discussion of the results and on the planning for 1974.

Study Group "Personnel Dosimetry"

Jülich, 2-3 October 1973,
5 participants.

Principal subject:

Coordination of work on neutron dosimetry between the Commissariat à l'Energie Atomique (CEA), Cadarache, and the Kernforschungsanlage (KFA) Jülich in the framework of contract 065-72-1 PST C.

Study Group "European Neutron Dosimetry Intercomparison Project"

Neuherberg-München, 23 October 1973,
5 participants from 3 countries and the Commission.

Principal subject:

Preparation of the "European Neutron Dosimetry Intercomparison Project".

Study Group "Mutation Breeding"

Grünbach, 6-8 November 1973,
36 participants from 4 countries and the Commission.

Principal subjects:

Incompatibility in higher plants.

Protein improvement.

Disease resistance induction.

The meeting was organized by the Association EURATOM-ITAL.

Study Group "Personnel Dosimetry"

Luxembourg, 13-14 November 1973,
30 participants.

Principal subject:

Basic principles of personnel dosimetry.

Study Group "Thorotrast"

Heidelberg, 23 November 1973,
15 participants.

Principal subjects:
State of thorotrast programme.

Dose distribution evaluated by autoradiographical methods.

Planning of experiments with animals.

State of the clinical programme.

Study Group "Chromium"

Ispra, 12 December 1973,
12 participants from 3 countries and the Commission.

Principal subject:
Behaviour of Chromium in soils, plants, fresh water and
aquatic organisms.

Study Group "Pollution Levels of the Environment"

Several meetings were held on this subject.

B.

Meetings organized or co-sponsored by
the Commission of the European Communities in 1973

Annual Assembly of the Council of the European Organization for
Research on Treatment of Cancer (E.O.R.T.C.)

Brussels, 20 January 1973,
19 participants from 8 countries.

Principal subjects:

Hormone receptors and therapy of hormone dependent cancers.

Proposal concerning the creation of a data center and a reviewing
and advisory committee for the evaluation of protocols submitted
by co-operative groups.

Meeting on European Primate Facilities

Rijswijk (Z.H.), 7 May 1973,
9 participants from 5 countries.

Principal subjects:

Proposals for collaboration of primate facilities in a European
framework:

- creation of large-scale breeding programmes,
- collaboration between existing and planned primate facilities,
- investigation into the existing provision and future needs of laboratory primates in Europe,
- possible sponsoring by the Commission.

Fourth Symposium on Microdosimetry

Verbania Pallanza, 24-28 September 1973,
140 participants from 16 countries or International Organizations
and the Commission.

This symposium was held in view of the increasing importance of microdosimetry for health physics and radiation protection, neutron therapy and radiobiology.

The principal subjects discussed were the physical, biological and chemical aspects of the spectral and spatial distribution of energy transferred to irradiated tissue, in particular to cells, cell components and biomacromolecules.

Proceedings, containing 56 papers, are published as Euratom Report No. 5122.

2nd Meeting on Fundamental and Practical Aspects of the Application of Fast Neutrons in Clinical Radiotherapy

The Hague, 3-5 October 1973,
150 participants from 15 countries and International Organizations.

The purpose of this meeting was the evaluation of fast neutron irradiation data obtained from experiments with normal tissues and tumours in animals and from treatments of tumours in patients. Future application of high-LET radiation for radiotherapy as well as technical questions, characteristics of sources and dosimetry had also been discussed.

International Colloquium "The Identification of Irradiated Foodstuffs"

Karlsruhe, 24-25 October 1973,
80 participants.

Collection and discussion of scientific information concerning the physical, chemical and biological changes in foodstuffs irradiated for conservation purposes, identification methods. Organized in conjunction with the "Bundesforschungsanstalt für Lebensmittel-frischhaltung".

Seminar on "Experiences with Iodine Filters in Nuclear Installations"

Karlsruhe, 4-6 December 1973,
100 participants.

Design, test methods in situ and in the laboratory, experiences with
iodine filters in nuclear installations.

C.

Meetings of Experts

Art. 31 and 37 Euratom Treaty in 1973

Group of Experts "Basic Safety Standards"

mentioned in article 31 of the Euratom Treaty.

Luxembourg, 11-12 January 1973,
22 participants.

Revision of the directives laying down Basic Safety Standards for the health protection of the population and workers against the dangers of ionizing radiations.

Group of Experts "Basic Safety Standards"

mentioned in article 31 of the Euratom Treaty.

Brussels, 29-30 May 1973,
22 participants.

Revision of the directives laying down Basic Safety Standards for the health protection of the population and workers against the dangers of ionizing radiations.

Group of Experts "Article 37"

Luxembourg, 13 June 1973,
20 participants.

Radioactive effluents from nuclear power stations in the European Community; discharge data, radiological aspects.

Group of Experts "Basic Safety Standards"

mentioned in article 31 of the Euratom Treaty.

Luxembourg, 6-7 December 1973,
22 participants.

Revision of the directives laying down Basic Safety Standards for the health protection of the population and workers against the dangers of ionizing radiations.

SALES OFFICES

The Office for Official Publications sells all documents published by the Commission of the European Communities at the addresses listed below, at the price given on cover. When ordering, specify clearly the exact reference and the title of the document.

UNITED KINGDOM

H.M. Stationery Office
P.O. Box 569
London S.E. 1 — Tel. 01-928 69 77, ext. 385

BELGIUM

Moniteur belge — Belgisch Staatsblad
Rue de Louvain 40-42 — Leuvenseweg 40-42
1000 Bruxelles — 1000 Brussel — Tel. 12 00 26
CCP 50-80 — Postgiro 50-80

Agency:
Librairie européenne — Europese Boekhandel
Rue de la Loi 244 — Wetstraat 244
1040 Bruxelles — 1040 Brussel

DENMARK

J.H. Schultz — Boghandel
Møntergade 19
DK 1116 København K — Tel. 14 11 95

FRANCE

*Service de vente en France des publications
des Communautés européennes — Journal officiel*
26, rue Desaix — 75 732 Paris — Cédex 15°
Tel. (1) 306 61 00 — CCP Paris 23-96

GERMANY (FR)

Verlag Bundesanzeiger
5 Köln 1 — Postfach 108 006
Tel. (0221) 21 03 48
Telex: Anzeiger Bonn 08 882 595
Postscheckkonto 834 00 Köln

GRAND DUCHY OF LUXEMBOURG

*Office for Official Publications
of the European Communities*
Case postale 1003 — Luxembourg
Tel. 4 79 41 — CCP 191-90
Compte courant bancaire: BIL 8-109/6003/200

IRELAND

Stationery Office — The Controller
Beggar's Bush
Dublin 4 — Tel. 8 54 01

ITALY

Libreria dello Stato
Piazza G. Verdi 10
00198 Roma — Tel. (6) 85 08
CCP 1/2640

NETHERLANDS

Staatsdrukkerij- en uitgeverijbedrijf
Christoffel Plantijnstraat
's-Gravenhage — Tel. (070) 81 45 11
Postgiro 42 53 00

UNITED STATES OF AMERICA

European Community Information Service
2100 M Street, N.W.
Suite 707
Washington, D.C. 20 037 — Tel. 296 61 31

SWITZERLAND

Librairie Payot
6, rue Grenus
1211 Genève — Tel. 31 89 50
CCP 12-236 Genève

SWEDEN

Librairie C.E. Fritzö
2, Fredsgatan
Stockholm 16
Post Giro 193, Bank Giro 73/4015

SPAIN

Libreria Mundi-Prasa
Castello 37
Madrid 1 — Tel. 275 61 31

OTHER COUNTRIES

*Office for Official Publications
of the European Communities*
Case postale 1003 — Luxembourg
Tel. 4 79 41 — CCP 191-90
Compte courant bancaire: BIL 8-109/6003/200

Price: B.Fr. 1.000