

European social statistics – Labour force survey results 1999

Data 1999



EUROPEAN
COMMISSION















THEME 3
Population
and social
conditions

..... Our mission is to provide the European Union with a high-quality statistical information service

Eurostat's collections are adapted to the needs of all users.
You will find them in each of the nine themes proposed by Eurostat.

- | | | | |
|-----------------------------------------------------------------------------------|-------------------------------------------|-----------------------------------------------------------------------------------|-----------------------------------|
|  | 1 General statistics |  | 6 External trade |
|  | 2 Economy and finance |  | 7 Transport |
|  | 3 Population and social conditions |  | 8 Environment and energy |
|  | 4 Industry, trade and services |  | 9 Research and development |
|  | 5 Agriculture and fisheries | | |

 Graphs	 Tables	 Comments	 Maps	Content	Format
<p>Press releases: Eurostat publishes around 100 press releases every year in connection with the release of new data. The press releases include the key figures on the EU, the Member States and their partners. They are provided free of charge. They are also available on the Internet as soon as they are published: www.europa.eu.int/comm/eurostat/</p>					Paper Html PDF
<p>Statistics in focus: This collection is published regularly by Eurostat and provides up-to-date summaries of the main results of statistical surveys, studies and analyses. It covers all themes and consists of about four to eight pages per issue. Eurostat issues around 150 <i>Statistics in Focus</i> per year. Available as single copies or on subscription.</p>					Paper PDF
<p>Key indicators: This collection provides the main indicators on a theme or sub-theme in an easy-to-carry booklet of up to 100 pages. Available as single copies or on subscription.</p>					Paper Html
<p>Panorama of the European Union: This collection highlights the features and trends of a multi-sectoral theme or a sectoral sub-theme. The publications consist of around 200 pages and include analysis as well as tables and graphs. Available as single copies or on subscription.</p>					Paper CD-ROM
<p>Methods and nomenclatures are intended for specialists who want to consult the methodologies and nomenclatures used for a theme, a sub-theme or a sector. Available as single copies.</p>					Paper CD-ROM
<p>Detailed tables are intended for specialists. They present part, or all, of the statistical data compiled on a theme, sub-theme or sector. Available as single copies or on subscription.</p>					Paper CD-ROM
<p>Studies and research summarise the results of European statistical studies and research and are intended for specialists. Available as single copies or on subscription.</p>					Paper CD-ROM
<p>Catalogues provide rapid access to concise information on Eurostat's products and services. They are free of charge and include the <i>Mini guide</i>, a selection of Eurostat products and services, and <i>Statistical references</i>, the quarterly newsletter on Eurostat's latest products and services.</p>					Paper

European social statistics – Labour force survey results 1999

Data 1999

.....



EUROPEAN
COMMISSION



THEME 3
Population
and social
conditions



..... Immediate access to harmonized statistical data

Eurostat Data Shops:

A personalised data retrieval service

In order to provide the greatest possible number of people with access to high-quality statistical information, Eurostat has developed an extensive network of Data Shops (*).

Data Shops provide a wide range of **tailor-made services**:

- ★ immediate information searches undertaken by a team of experts in European statistics;
- ★ rapid and personalised response that takes account of the specified search requirements and intended use;
- ★ a choice of data carrier depending on the type of information required.

Information can be requested by phone, mail, fax or e-mail.

(* See list of Eurostat Data Shops at the end of the publication.

Internet:

Essentials on Community statistical news

- ★ Euro indicators: more than 100 indicators on the euro-zone; harmonized, comparable, and free of charge;
- ★ About Eurostat: what it does and how it works;
- ★ Products and databases: a detailed description of what Eurostat has to offer;
- ★ Indicators on the European Union: convergence criteria; euro yield curve and further main indicators on the European Union at your disposal;
- ★ Press releases: direct access to all Eurostat press releases.

For further information, visit us on the Internet at: www.europa.eu.int/comm/eurostat/

A great deal of additional information on the European Union is available on the Internet. It can be accessed through the Europa server (<http://europa.eu.int>).

Cataloguing data can be found at the end of this publication.

Luxembourg: Office for Official Publications of the European Communities, 2000

ISBN 92-828-9037-6

© European Communities, 2000

Printed in Luxembourg

PRINTED ON WHITE CHLORINE-FREE PAPER



EUROSTAT

L-2920 Luxembourg — Tel. (352) 43 01-1 — Telex COMEUR LU 3423
Rue de la Loi 200, B-1049 Bruxelles — Tel. (32-2) 299 11 11

Eurostat is the Statistical Office of the European Communities. Its task is to provide the European Union with statistics at a European level, that allow comparisons to be made between countries and regions. Eurostat consolidates and harmonizes the data collected by the Member States.

To ensure that the vast quantity of accessible data is made widely available, and to help each user make proper use of the information, Eurostat has set up a publications and services programme.

This programme makes a clear distinction between general and specialist users and particular collections have been developed for these different groups. The collections *Press releases*, *Statistics in focus*, *Panorama of the European Union*, *Key indicators* and *Catalogues* are aimed at general users. They give immediate key information through analyses, tables, graphs and maps.

The collections *Methods and nomenclatures*, *Detailed tables* and *Studies and research* suit the needs of the specialist who is prepared to spend more time analysing and using very detailed information and tables.

All Eurostat products are disseminated through the Data Shop network or the sales agents of the Office for Official Publications of the European Communities. Data Shops are available in 12 of the 15 Member States as well as in Switzerland, Norway and the United States. They provide a wide range of services from simple database extracts to tailor-made investigations. The information is provided on paper and/or in electronic form via e-mail, on diskette or CD-ROM.

As part of the new programme Eurostat has developed its website. It includes a broad range of on-line information on Eurostat products and services, newsletters, catalogues, on-line publications as well as indicators on the euro-zone.

Yves Franchet
Director-General

Preface

This publication is the latest in a series in which Eurostat presents European social statistics. About six issues will appear every year, covering in turn all social fields and replacing the individual publications which have previously been produced. Issues planned for 2000 include Poverty and Social Exclusion, Vocational Education and Training, Demographic Data and Social Protection.

This innovation is part of the modernisation of Eurostat's publications programme. Detailed figures will increasingly become available primarily through the Eurostat website. The main social indicators will be collected together in the statistical pocket-book *Living Conditions in Europe*, and a general overview will be provided under the title *The Social Situation in the European Union*.

This publication presents the detailed results of the 1999 (1998 for Greece) Labour Force Survey conducted in the Member States of the European Union in accordance with Council Regulation (EC) No 577/98.

This survey, like its predecessors conducted between 1983 and 1997, was based on the International Labour Office guidelines on labour force statistics as adopted by the 13th International Conference of Labour Statisticians in 1982 and subsequently confirmed at the 14th and 15th conferences in 1987 and 1993.

The contents and methodology of this new survey are described in the Eurostat publication *The European Union Labour Force Survey: Methods and Definitions 1998*. Some of the definitions given there and a brief description of the national surveys are reproduced below in the explanatory notes.

Eurostat wishes to thank all those involved at the national statistical offices for their contributions to the success of the survey in preparing the questionnaires, selecting the samples, conducting the interviews and transmitting the data to Eurostat.

Luxembourg, March 2000

Signs and abbreviations

--	Zero or not available
.	Not zero but extremely unreliable
()	Data unreliable owing to small size of the sample
EU-15	All 15 Member States of the European Union
EUR-11	Euro-zone (Belgium, Germany, Spain, France, Ireland, Italy, Luxembourg, Netherlands, Austria, Portugal and Finland)

Table of contents

	Page
Preface	3
Table of contents	5
Explanatory notes	8
Labour force classification in the European Union Labour Force Survey	14
Distribution of the interviews by reference week	15
Characteristics of national surveys in 1999	16
Sample design and data collection	28
Population and households	31
<i>Graphs</i>	
01 Activity rates by age group	32
02 Activity rates of population aged 15-64 years old	32
03 Population aged 15-24 years old not in education and with low educational attainment level	33
04 Composition of private households	33
<i>Tables</i>	
01 Population by age group	34
02 Population by nationality and age group	36
03 Population by marital status and age group	38
04 Population, aged 15 years or more, by age group and labour status	40
05 Population, aged 15 years or more, by degree of urbanisation of residence and labour status	42
06 Population, aged 15 to 59 years, in education	44
07 Population, aged 25 to 59 years, by age group and educational attainment level	46
08 Active population by age group and nationality	48
09 Composition of private households	50
10 Population by household position	52
11 Female population, aged 20 to 49 years, by the number of children and by labour status	54
12 Main characteristics of population and households by region	56
Employment	65
<i>Graphs</i>	
05 Employment rates of population aged 15 to 64 years old	66
06 Employment by professional status	66
07 Employment by economic activity	67
08 Temporary employees as percentage of total employees	67
09 Part-time as percentage of total employment	68
10 Population in employment working usually from home, shift work, in the evening, at night, on Saturday and/or on Sunday	68
11 Average weekly hours of work for all in employment	69
12 Average weekly hours of work by type of employment	69
Employment rates	71
<i>Tables</i>	
13 Employment rates by age group and nationality	72
14 Employment rates by age group and educational attainment level	74

All in employment	77
--------------------------------	----

Tables

15	Employment by age group and nationality	78
16	Employment by professional status	80
17	Employment by economic activity	82
18	Employment by occupation	84
19	Employment by place of work (work from home)	86
20	Male population, aged 15 to 59 years, in employment by occupation and educational attainment level	88
21	Female population aged 15 to 59 years, in employment by occupation and educational attainment level	90

Self-employment	93
------------------------------	----

Tables

22	Self-employment by age group and educational attainment level	94
23	Self-employment by economic activity	96
24	Self-employment by occupation	98

Employees	101
------------------------	-----

Tables

25	Employees by age group and educational attainment level	102
26	Employees by economic activity	104
27	Employees by occupation	106

Temporary employees	109
----------------------------------	-----

Tables

28	Temporary employees as percent of the total employees by age group	110
29	Temporary employees by age group and educational attainment level	112
30	Temporary employees by economic activity	114
31	Temporary employees by occupation	116
32	Temporary employees by age group and reason	118
33	Temporary employees by duration of the work contract	120

Part-time employment	123
-----------------------------------	-----

Tables

34	Part-time employment as percent of each age group total employment	124
35	Part-time employment by age group and educational attainment level.....	126
36	Part-time employment by economic activity	128
37	Part-time employment by occupation	130
38	Part-time employment by reason	132
39	Involuntary part-time employment as percent of total part-time employment by age group	134

All in employment having a second job	137
----------------------------------------------------	-----

Tables

40	Person in employment having a second job by professional status of both jobs	138
41	Person in employment having a second job by by occupation in first job	140

Working time	143
---------------------------	-----

Tables

42	Population usually working shift work, in the evening, at night on Saturday or on Sunday, as percentage of the total employment	144
43	Persons working shift work, in the evening, at night on Saturday or on Sunday	146
44	Average actual weekly hours of work in main job during the reference week, for all in employment	148
45	Average usual weekly hours of work in main job, for all in employment	150
46	Average usual weekly hours of work of self-employment by economic activity	152
47	Average usual weekly hours of work of full-time employees by economic activity	154
48	Average usual weekly hours of work of part-time employees by economic activity	156
49	Average usual weekly hours of work of self-employment by occupation	158
50	Average usual weekly hours of work of full-time employees by occupation	160
51	Average usual weekly hours of work of part-time employees by occupation	162
52	Main characteristics of employment by region, for the population aged 15 to 64 years	164

Unemployment	173
---------------------------	-----

Graphs

13	Population by age group	174
14	Unemployment rates by educational attainment level	174
15	Previous work situation of the unemployed	175
16	Methods used by the unemployed for seeking work	175

Tables

53	Unemployment rates by age group	176
54	Unemployment rates by age group and educational attainment level	178
55	Principal characteristics of unemployment	180
56	Unemployment by age group and nationality	182
57	Unemployment by duration	184
58	Unemployment by age group and duration as percentage of the total unemployment	186
59	Unemployed by age group and type of employment sought	188
60	Previous occupation of the unemployed	190
61	Methods used for seeking work	192
62	Main characteristics of unemployment by region	194

Inactivity	203
-------------------------	-----

Graphs

17	Inactive population as percentage of the population in each age group	205
18	Proportion of inactive population who would like to work but think no job is available	205

Tables

63	Inactive population as percentage of the total population, by age group	206
64	Inactive population by age group and nationality	208
65	Inactive population, aged 15 years or more, by willingness to work and reasons for not seeking employment	210
66	Main characteristics of inactivity by region	212

Explanatory notes

Organisation of the survey

The content of the European Labour Force Survey is determined by the Statistical Office of the European Union (Eurostat), together with the national experts of the Member States. An agreed coding scheme is then used by the Member States to transmit the data.

A detailed presentation of the information provided by the survey is given in Annex IV of Commission Regulation (EC) No 1571/98, which lays down the rules for applying Council Regulation No 577/98 on the organisation of a labour force sample survey in the Community.

The national statistical institutes are responsible for selecting the sample, preparing the questionnaires, conducting the direct interviews with households and forwarding the results to Eurostat in accordance with the standard coding scheme.

Eurostat is responsible for processing and disseminating the information forwarded by the national institutes. The sampling methods, adjustment procedures and definitions and the standardised coding system are described in the publication *The European Union Labour Force Survey – Methods and Definitions 1998*.

Reference period

The labour force characteristics of each person interviewed refer to her or his situation in a given reference week. The new Regulation provides for the organisation of a continuous survey (the reference weeks distributed uniformly across the year) to provide quarterly results. Member States not in a position to conduct a continuous survey are provisionally authorised to conduct a single, annual survey in the spring. In 1999, therefore, some Member States still have an annual survey with a single reference week.

To harmonise the reference period and maintain a degree of consistency with previous publications, this volume shows the results of the second quarter (April to June). The results for the United Kingdom correspond to the spring and those for France and Austria correspond to the first quarter. Data for the Netherlands covers the 2 first quarters.

The distribution of the reference weeks is set out in Table 1; Table 2 summarises the national survey methodologies.

Scope of the survey

The survey is intended to cover the whole of the resident population, i.e. all persons whose usual place of residence is in the territory of the 15 Member States of the European Union.

For technical and methodological reasons, however, it is not possible in all countries to include the population living in collective households, i.e. persons living in residential homes, boarding houses, hospitals, religious institutions, workers' hostels, etc.

To harmonise the scope of the survey, therefore, the Community results are compiled on the basis of the population of private households only. This comprises all persons living in the households surveyed during the reference week. This definition also includes persons absent from the household for short periods (but having retained a link with the private household) owing to studies, holidays, illness, business trips etc.

The sampling method was chosen separately by each Member State (Table 2). The plan adopted in each case was required by the Regulation to ensure a minimum level of reliability at regional level, expressed as follows:

"For a group of unemployed people representing 5% of the working age population the relative standard error for the estimation of annual averages at NUTS II level shall not exceed 8% of the sub-population in question" (Council Regulation (EC) No. 577/98, Article 3.1).

The number of private households for which data were finally available from each Member State is set out in Table 1.

Reliability of the results

Sampling error

As with any sample survey, the results of the labour force survey are subject to sampling error. It is almost certain that somewhat different figures would have been obtained if a complete census had been carried out

using the same questionnaires, interviewers, supervisors, data-processing techniques, etc. as were used in this survey. This difference is known as the "sampling error" of the estimate.

For a given sample, there are basically two factors which account for the relative magnitude of the sampling error in the measurement of a population characteristic: the frequency with which the characteristic occurs, and the evenness with which it is distributed among the population. The higher of two estimates is likely to have a smaller percentage sampling error; where two estimates are of comparable size, the one which refers to a characteristic more evenly spread throughout the population would, in general, be subject to smaller relative sampling error.

In this publication, results likely to have very wide margins of relative sampling error have been replaced by a dot, and other relatively imprecise estimates are shown in brackets.

Survey response

A significant source of non-sampling error in the labour force survey is the effect of non-response on the results. Non-response rates are usually less than 10% in countries where the survey is compulsory, but can reach 40% in countries where the survey is optional (Table 2). Adjustment for non-response was made in the majority of countries by re-weighting the results; in some cases the method used was 'duplication' or 'substitution' of units. Quality checks carried out in various countries suggest that one-person households may be under-represented in the sample, as they tend to be more difficult to contact than households containing several persons.

Weighting

The 1999 survey results were weighted by population estimates derived independently for the various categories of age, sex, region, nationality, etc. More information about weighting and adjustment procedures can be found in *The European Union Labour Force Survey - Methods and Definitions 1998*.

Basic concepts and definitions

Labour status

The concepts and definitions used in the survey are those contained in the Recommendation of the 13th International Conference of Labour Statisticians, convened in 1982 by the International Labour Organisation (and therefore referred to throughout these notes as the 'ILO guidelines'). All these definitions apply to persons aged 15 years and over, living in private households.

Persons in employment are those who during the reference week did any work for pay or profit, or were not working but had jobs from which they were temporarily absent. Family workers are included.

Persons in employment are those who, during the reference week:

- (a) had no employment, and
 - (b) were available to start work within the next two weeks, and
 - (c) had actively sought employment at some time during the previous four weeks.
- Persons having found jobs which were to start later are also classed as unemployed.

Inactive persons are those not classed as either employed or unemployed.

The *labour force* comprises persons in employment and unemployed persons.

A flowchart classifying the population according to these definitions is shown on page 14.

Rates

The *activity rate* expresses the labour force as a percentage of the population of working age living in private households.

The *employment rate* expresses persons in employment as a percentage of the population of working age living in private households.

The *unemployment rate* expresses unemployed persons as a percentage of the labour force.

Age

The age of the declarant is calculated from the year of birth. For persons born in the same year, those whose

birthdays fall between 1 January and the end of the reference week are, for the purposes of survey results analysis, regarded as being one year older than those whose birthdays fall after the end of the reference week. This definition applies to all tables incorporating an age structure.

Nationality

For the sake of reliability, the results by nationality are shown only in three groups: nationals of the Member State concerned, non-nationals of the Member State who are nationals of one of the other 14 Member States of the European Union, and a third group comprising all other nationalities.

Marital status

In this context, marital status is a legal concept and does not therefore necessarily match the real household situation in terms of cohabitation arrangements. This definition applies to all tables incorporating this variable.

Degree of urbanisation

The concept of "urbanisation" was introduced to indicate the character of the geographical area in which the surveyed person lives. Three types of area have been identified:

densely-populated area;
intermediate area;
sparsely-populated area.

A "area" consists of a group of contiguous "local areas" which correspond to the following entities in the Member States concerned:

Belgique/Belgie:	Commune/Gemeente
Danmark:	Kommune
Deutschland:	Gemeinde
Ellada:	Demos
España:	Municipio
France:	Commune
Ireland:	DED/ward
Italia:	Commune
Luxembourg:	Commune
Nederland:	Gemeente
Österreich:	Gemeinde
Portugal:	Freguesia
Suomi/Finland:	Kunta
Sverige:	Kommune
United Kingdom:	Ward

The three types of area described above are defined as follows:

Code 1: densely-populated area

A contiguous set of local areas each with a population density exceeding 500 inhabitants per km², where the total population of the set is at least 50 000 inhabitants.

Code 2: intermediate area

A contiguous set of local areas not belonging to a densely-populated area, each local area with a population density exceeding 100 inhabitants per km², the set either having a total population of at least 50 000 inhabitants or lying adjacent to a densely-populated area.

Code 3: thinly-populated area

A contiguous set of local areas not forming part of a densely-populated or intermediate area.

A set of local areas with a total area of less than 100 km² and less than the required population density which is entirely enclosed within a densely-populated or intermediate area should be regarded as part of this area. If the area is surrounded by a densely-populated area and an intermediate area, it is regarded as part of the intermediate area.

Professional status

Employer employing one or more employees

Employers are defined as persons who work in their own business, professional practice or farm for the purpose of earning a profit, and who employ at least one other person.

Self-employed person not employing any employees

Self-employed persons not employing any employees are defined as persons who work in their own business, professional practice or farm for the purpose of earning a profit, and who employ no other persons.

Employee

Employees are defined as persons who work for a public or private employer and who receive compensation in the form of wages, salaries, fees, gratuities, payment by results or payment in kind; non-conscript members of the armed forces are also included.

Family worker

Family workers are persons who help another member of the family to run a farm or other business, provided they are not classed as employees.

Economic activity

Economic activity is coded as in NACE Rev.1.

Occupation

This is coded as in ISCO-88 (COM), based on the International Standard Classification of Occupations (ISCO-88) published by the International Labour Organisation (Geneva, 1990).

Employees with fixed-term contracts

In the majority of Member States, most jobs are based on written work contracts. In some countries, however, contracts of this type are concluded only in specific cases (e.g. for public-sector jobs, apprentices or other trainees within an enterprise). Given these institutional discrepancies, the concepts of “temporary employment” and “work contract of limited duration” (or “permanent employment” and “work contract of unlimited duration”) describe situations which, in different institutional contexts, may be considered similar. A job may be considered temporary if employer and employee agree that its end is determined by objective conditions such as a specific date, the completion of a task or the return of another employee who has been temporarily replaced. Where there is a work contract of limited duration, it usually states the terms of the end of the contract.

The following belong to these categories:

- (a) persons with seasonal employment;
- (b) persons engaged by an agency or employment exchange and hired to a third party to perform a specific task (unless there is a written work contract of unlimited duration with the agency or employment exchange);
- (c) persons with specific training contracts. If there are no objective criteria for the end of a job or work contract, this should be considered permanent or of unlimited duration.

Full-time/part-time

The distinction between full-time and part-time work should be based on a spontaneous response by the declarant. It is impossible to make a more precise distinction between full-time and part-time employment, since working hours differ from one Member State to the next and from one branch of activity to the next.

Involuntary part-time employment

Persons declaring that they work part-time because they are unable to find full-time work should be placed in this category.

Homeworking

This concept applies to many self-employed persons exercising, for example, an artistic or liberal profession and working solely or partly at home, often in a part of the premises set aside for the purpose. However, if the workplace consists of a separate unit adjacent to the person's living unit but with a separate entrance (a doctor's consulting room or a tax consultant's office, for example), the work done on these premises should not be classed as “homework”. Similarly, a farmer should not be considered as “working at home” when occupied in fields or buildings adjacent to his or her home. In the case of employees, “homework” should be interpreted strictly on the basis of formal agreements concluded with the employer, in which both parties,

employee and employer, agree that part of the work is to be done at home. Such an agreement may either be stated explicitly in the work contract or recognised in another way (e.g. if the employee informs the employer explicitly of his or her work by completing a suitable form or by applying for additional pay or another form of compensation). Such an agreement is also recognised if the employee is provided with a home computer for performing his or her work. Other typical examples of homeworking include sales representatives who prepare at home for the meetings they are to conduct with clients in their offices or homes, and persons doing typing or knitting which is then sent to a central collection point.

“Homework” does not cover employees choosing to work at home for personal or emergency reasons but whose work contract stipulates that they could equally have done the work at the workplace.

A person is considered “usually” to work at home if, for a reference period of four weeks before the interview, he or she has worked at home under the type of agreement described above and the hours worked at home amount to at least half of the total hours worked during the period.

A person is considered “sometimes” to work at home if, for a reference period of four weeks before the interview, he or she has worked at home under the type of agreement described above but the hours worked at home amount to less than half of the total hours worked during the period.

A person is considered “never” to work at home if, for a reference period of four weeks before the interview, he or she has on no occasion worked at home under the type of agreement described above.

Evening or night work

Since the definitions of evening and night differ widely, it is not easy to establish a strictly uniform basis for all Member States. In general, however, “evening work” may be considered to be work done after usual working hours but before the usual hours of sleep in the Member State concerned. It implies the opportunity to sleep at normal times.

“Night work” may generally be regarded as work done during usual sleeping hours and implies abnormal sleeping times.

In this context, “usually” may be interpreted as meaning at least half the number of days on which the person worked during a four-week reference period before the interview, “sometimes” as less than half the number of days worked (but at least one occasion) and “never” as no occasion during the four-week reference period preceding the interview.

Saturday or Sunday working

This concept should be interpreted strictly on the basis of formal agreements concluded with the employer. Employees taking office work home and/or occasionally working at the workplace on Saturday or Sunday should not be included under this heading.

In this context, “usually” may be interpreted as meaning two or more Saturdays (or Sundays) during a four-week reference period before the interview, “sometimes” as one Saturday (or Sunday) in this period and “never” as no Saturday (or Sunday) during the four-week reference period preceding the interview.

Shift work

The question of shift work applies only to employees. Shift work is defined as the division of the 24-hour day into two or more shifts or distinct periods of work done by employees according to a regular rotation system. An employee is thus classed as a shift worker if he or she works two or more regular shifts. Persons working fixed hours (i.e. whose working hours do not vary appreciably) are not considered to be shift workers.

In this context, “usually” may be interpreted as meaning that the person’s working hours have changed radically more than once during a four-week reference period before the interview, “sometimes” as meaning that the person’s working hours have changed radically only once (and no more) during the four-week reference period, and “never” as meaning that there was no significant change in the person’s working hours during a four-week reference period preceding the interview.

Number of hours usually worked per week

The number of hours in this context is the number of hours usually worked by the person concerned. Paid or unpaid overtime usually worked by the person must be included, but travelling time between home and workplace and the time taken for the main meal break (usually at lunchtime) are excluded. Persons who usually also do homework should include the number of hours they usually work at home. Apprentices, trainees and other persons learning a job should exclude any time spent at college or in other special training centres. Some persons, particularly self-employed persons and family workers, may not have a usual timetable because their working hours vary widely from one week or month to the next. If a declarant cannot provide a figure for his or her usual working hours, the average number of hours per week actually worked over the past four weeks should be counted as usual working hours.

Population in education or training

The data collected refer to education or vocational training which are relevant to the declarant's current or future employment (see the new ISCED or International Standard Classification of Education, UNESCO 1997).

They should include initial education, additional education, continuing or additional training, training in enterprises, apprenticeships, on-the-job training, seminars and workshops, distance education, evening classes, self-learning etc. They should also include courses followed out of personal interest only and may cover all forms of learning and training in subjects such as languages, computer studies, business studies, art and culture, health and medicine.

Duration of unemployment

Duration of unemployment is defined as:

- (a) the duration of search for a job, or
- (b) the length of the period since the last job was held (if this period is shorter than the duration of search for a job).

Comparability with previous surveys

The systematic use of the ILO concepts and definitions in the European Labour Force Survey since 1983 has guaranteed comparability of the results of all surveys conducted since that year. The results of the surveys held before 1983 are not comparable.

The stricter application of the ILO guidelines as from the 1992 survey may cause a slight break between the 1983-91 series and the series from 1992 onwards. However, the fact that both series are based on the ILO guidelines ensures that the differences are minimal. These differences are explained in detail in the publication *The European Union Labour Force Survey – Methods and Definitions 1998*.

The transition to a continuous survey requires a revision of the sampling design which can also cause ruptures in the time series. This is the case for Greece and Portugal in 1998 and for Belgium in 1999.

In Belgium, the question about the distinction between part-time or full-time work was put only to the employees. Taking into account that part-time work is more frequent among employees, this can introduce a rupture into the series.

The introduction of new ISCED (1997 version) introduces a break in the time series of the highest level of education attained in Luxembourg and United Kingdom.

In the Finnish survey, only the 15-year-old people and more are interviewed. The results published for less than 15 years are based on estimates provided separately by this country.

When these results were published, certain variables were not provided yet by the following countries:

- Education or training received during the last 4 weeks (Austria, Ireland)
- Level of education attained (Ireland)
- The Household composition (Denmark, Ireland, Sweden and Finland)
- Occupation (Ireland)
- Working at home (Ireland)
- Shift work, evening work, night work, Saturday work, Sunday work (Germany, Spain, Ireland and Luxembourg)
- Permanence of employment (Ireland)
- Duration of unemployment (Ireland)
- Occupation in the last employment (France, Ireland, the Netherlands, Sweden)
- Type of employment sought (Ireland)
- previous professional experience of the unemployed persons (Ireland)

The results published for these variables correspond to the last available. The totals for EU 15 and EUR 11 are calculated using the last results available what can introduce inconsistencies (between tables) for the presented totals according to whether they would be calculated with results of 1999 or of previous years.

Labour force classification in the European Union Labour Force Survey

Person of 15 years or more living in a private household

Person did any work for pay or profit during the reference week

Person was not working but had a job or business from which absent in the reference week

Unpaid family worker

Person was not seeking employment because a job which would start later had already been found

Person was seeking employment

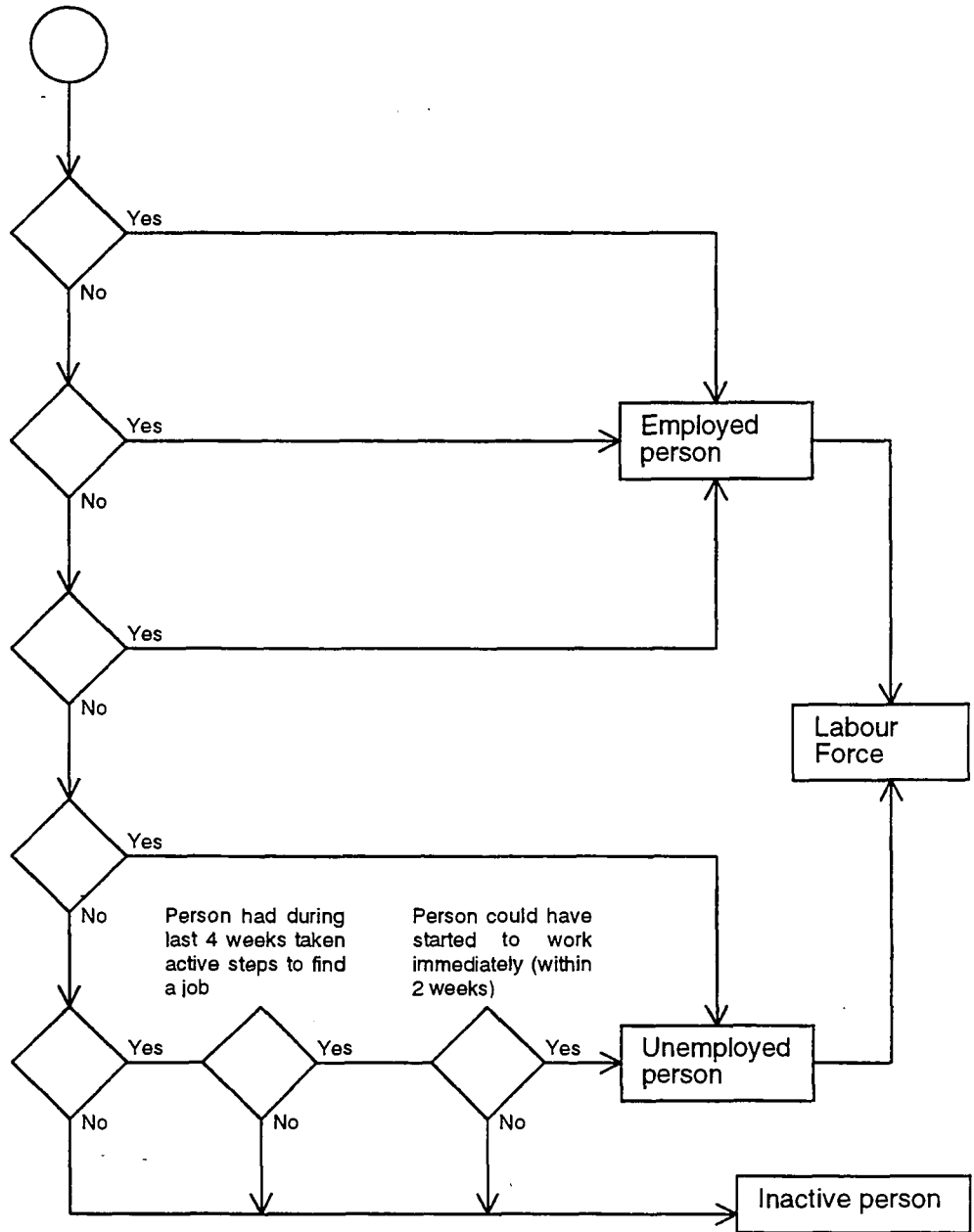

Table 1- Distribution of the interviews by reference week (in % of the interviews done in each country in 1999)

Reference week	B	DK	D	EL ⁽²⁾	E	F	IRL	I	L	NL	A	P	FIN	S	UK
1						25.0				5.3					
2						23.4				6.9					
3						21.4				5.7					
4						13.1				3.7					
5						9.5				7.4				7.8	
6						6.1				7.0				7.9	
7						1.5				4.2				7.5	
8										3.4	0.6			7.4	
9										5.8	41.9			6.2	
10										7.1	32.3			6.3	7.6
11										4.8	24.5		0.6	10.2	7.8
12										3.0	0.7			6.0	7.6
13										2.0	0.1			5.8	7.8
14	8.5	8.9		8.6	7.8		7.9	100.0		4.3		7.7		9.0	7.8
15	7.9	7.1		8.1	7.8		7.6			6.2		7.3	30.2	8.7	7.6
16	7.2	8.3	100.0	8.0	7.5		7.8		100.0	4.2		7.9	0.6	8.6	7.5
17	8.2	7.0		7.4	7.9		7.4			2.0		7.0		8.6	7.8
18	7.6	8.4		7.8	7.7		7.7			3.8		8.4			7.9
19	7.4	7.3		8.0	7.9		7.8			4.1		7.4	30.3		7.8
20	7.7	8.6		7.5	7.6		7.8			5.4		8.1	0.6		7.6
21	7.8	7.2		7.9	7.8		7.7			2.8		7.6			7.6
22	7.9	8.3		7.3	8.0		7.7			0.9		8.2			7.5
23	6.9	7.3		7.2	7.9		7.8					7.6			
24	7.6	7.3		7.4	7.6		7.7					7.9	37.6		
25	7.2	7.1		7.5	7.6		7.7					7.4			
26	8.1	7.1		7.4	6.7		7.6					7.5			
Number of households ⁽¹⁾	11302	-	147799	31219	64329	75033	-	75173	5570	20424	24057	16640	-	-	60345

⁽¹⁾ Number of private households for which data is available

⁽²⁾ 1998

Characteristics of national surveys in 1999

BELGIUM

General

Participation in the survey is compulsory.

The survey becomes continuous since January and provides quarterly and yearly results.

The survey covers the entire country. Only private households are included.

The resident population comprises members of households residing on the national territory as at 1 January.

The household is the simple or collective unit comprising either one person living alone or two or more persons, whether or not of the same family, who usually occupy the same dwelling and live there communally.

Sampling plan

The yearly sample size foreseen is 47840 households, which represents an average survey rate of about 1.2%. Every week 920¹ households are interviewed.

The survey is based in a 2 level stratified sampling plan.

The survey base is the National Register of Persons, which is derived from communal population registers.

For the purpose of the survey, the entire national territory is divided into "provinces" (NUTS 2) forming 11 strata. The sample is proportional to the square root of the number of households in each "province". This increases the sampling rate of the least populated strata.

Within each stratum, a survey is carried out in two stages. The primary units comprise parts of the "communes" denominated "statistical sections" (6192 in the whole country, with 676 households in average and covering 5 Km² in average). Their probability of selection is proportional to the number of households in them, with eventual replacement of a "small" section (at least 27 households) by another section of the same "commune". The "small" sections only represent 0,15% of the total number of households.

The secondary sampling unit is the household.

Within each primary unit, 20 households (as well as 5 reserve households) are drawn at random using a method which ensures that the entire register of the primary unit in question is covered.

The overall survey rate (primary and secondary units) is identical for all communes in each stratum.

Weighting procedure

Extrapolation to the population, including adjustments for non-response, is done at the level of individuals. The population and the sample are the subject of a *posteriori* stratification by "province", sex and age (5 year age groups). In each of the strata thus obtained, a weighting is calculated whose numerator is the population as at 1 January 1999 according to the National Register of Persons and whose denominator the number of usable responses.

Data collection

The detailed information (related to individuals aged 15 years and over) is collected by means of face-to-face interviews in the 3 weeks following the week of reference. In households of retired persons, interviews can be conducted by telephone. The field staff comprises 350 persons.

In 1999, 27% of the interviews (of persons aged 15 years and over) were carried out by authorised third parties. The response rate is 84% (2% of the interviews could not be conducted due to unavailability of the interviewers; 2% of non-responses were due to refusals. The other non- response were due to long-term absences, deaths or changes of address. After taking up the reserve households the response rate becomes 95% .

A second interview takes place 3 months after (except for people aged 65 years and over) by mail or by telephone, with a shorter version of the questionnaire which aims only to measure the ILO labour situation (employed, unemployed inactive). For these second interviews the response rate is around 93%.

DENMARK

General

There is no specific national legislation making it compulsory to provide information for the survey, and

¹ In fact, only 874 could be contacted and accepted to answer

participation is therefore voluntary.

The entire country is covered, apart from Greenland and the Faroe Islands.

The survey covers both private and collective households.

It is a continuous one, providing quarterly results.

The resident population is the population of Denmark (excluding Greenland and the Faroe Islands) and included in the Central Population Register.

A household comprises a person living alone or a couple living at the same address. Children are included in the household if they:

- live with their parents,
- do not have children themselves, and
- are not or have not been married and have not lived with another person as a couple.

Sampling plan

The sample comprises 5 000 persons registered as unemployed during the quarter preceding the survey and 10 600 other persons. The sample is drawn from persons aged between 15 and 66 years whose names appear in the Population Register.

The sample size is 15 600 persons, which represents an average survey rate of 0.4%.

The survey base is the Central Population Register.

The sampling unit is the individual.

One-third of the individuals selected were questioned the previous quarter and one-third the year before (except for persons who refused to respond). One-third of the sample is renewed each quarter.

Weighting procedure

For the part of the sample comprising registered unemployed persons, an *a posteriori* stratification by age, income and level of educational attainment is carried out. For the remainder of the sample, the *a posteriori* stratification is carried out on the basis of age, gross income and sector of activity.

For each subsample, matrices are constructed using the stratification variables. The matrices are devised for the entire population and for the interviewees. The weightings are obtained by dividing the total population matrix by that of the people interviewed.

Data collection

Information is collected by means of CATI, supplemented by questionnaires sent by post to persons who could not be contacted by telephone.

The field staff comprises 50 persons.

In 1999, 1-2% of interviews were carried out by authorised third parties.

The response rate is 70%, with between 6 and 10% of non-responses being due to refusals. The exact percentage of refusals is difficult to calculate, because it is impossible to know if a questionnaire sent by post but not returned represents a refusal or some other reason.

GERMANY

General

The German LFS is carried out as part of the annual microcensus, which was begun in 1957.

The Statistical Law of January 1996 ("Gesetz zur Durchführung einer Repräsentativstatistik über die Bevölkerung und den Arbeitsmarkt sowie die Wohnsituation der Haushalte (Mikrozensusgesetz)") makes it compulsory to provide the information required under the microcensus, which in fact includes both a compulsory and an optional part.

The survey covers both private and collective households, except for military quarters. National service personnel are covered via their parents living in private households.

There is only one reference week.

The resident population is that whose main place of residence is in the territory of the Federal Republic. Foreign armed forces and members of the diplomatic corps and their families are excluded.

A private household comprises either a person living alone or two or more persons, whether or not they are of the same family, who usually occupy the same dwelling and share a common budget.

Sampling plan

For the "old" *Länder*, the survey base is taken from the 1987 census records, updated to take account of new dwellings.

For the new *Länder*, the data contained in the central population registers are reduced to the number of persons and the number of households at each address. The base is updated annually using statistical returns on the construction of new dwellings.

The sampling unit is the household.

The sampling districts comprise a number of dwellings.

All buildings are attributed to one of strata, depending on the number of dwellings which they comprise. The first stratum contains a number of buildings which are close to one another (but not necessarily contiguous) and comprising fewer than five dwellings. In this stratum, each sampling district comprises 12 dwellings.

The second stratum comprises buildings with between five and 10 dwellings. Each of these buildings constitutes a sampling district.

The buildings in the third stratum comprise 11 houses or more. In this stratum, the "sampling district" is a subdivision of the building, the target size being six dwellings.

An additional stratum covers the population living in collective households. It is divided into sampling units with a target size of 15 persons.

All persons in a selected sampling district are interviewed.

The stratification by region and size of the buildings is based on the size classes used to work out the sampling units. The sampling rate varies from one region to another. Within each stratum, an effect similar to stratification is obtained by systematic sampling in a list classified by geographical entity.

The regions comprise an average of 350 000 inhabitants. The list of sampling districts is sorted within each stratum by sub-region, *Kreis* (administrative district), the size class of the commune, commune and number of the sample district. This list is divided into groups of 100 consecutive sampling districts. A sample of 1% is drawn at random for the microcensus in each of these groups. A systematic subsample of 1% of the sample is used for the LFS. To reach the degree of sampling error required at NUTS II level (as laid down in the Regulation), the rate of sub-sampling varies: either 100%, 80%, 60% or 40%, giving overall sampling rates of 1%, 0.8%, 0.6% or 0.4%.

The sample comprises about 380 000 persons, giving an average sampling rate of 0.45%.

A rotation system comprising four waves is used. Each unit remains in the sample for four years and 25% of the sample is replaced each year.

Weighting procedure

A two-stage adjustment procedure is used.

a) If possible, limited data are collected for households which fail to respond. These data can include: household size, nationality (German/foreign) and, for households comprising only one person, age (under or over 60 years) and sex. From these data, the weightings of respondent households are increased to take account of non-responses in the region.

b) The sample, weighted to take account of non-response, is stratified *a posteriori* by region, sex and nationality (German/foreign) and is extrapolated to the population (adjusted to take account of military personnel).

Data collection

All the information is collected by means of face-to-face interviews, supplemented by written answers. Nevertheless, some *Länder* have begun to collect information using portable computers.

The field staff comprises 7 000 persons.

Information on the percentage of interviews carried out by authorised third parties is not available.

The response rate amounts to 97.8%. Non-responses are due almost exclusively to difficulties contacting the household.

However, the rate of non-response to some questions in the optional part of the questionnaire is up to 40%.

GREECE (1998)

General

The survey is a continuous survey providing quarterly results.

It covers only private households.

The resident population comprises persons who usually reside on Greek territory and who spend most days and nights there.

Sampling plan

The sample size is about 30 000 households, which represents a survey rate of 0.87%.

The survey base for samplings is based on the census.

The sampling unit is the household.

Stratification is carried out by administrative region and degree of urbanisation.

Thus, each NUTS II region constitutes the first stratification level. Within each NUTS II region, communes and municipalities are stratified according to:

- a) the Department (NUTS III region) to which they belong
- b) the population of the main town, by the following classes (in thousands of inhabitants): > 50, 30-49.999, 10-29.999, 5-9.999, 2-4.999, 1-1.999, 0.5-0.999, <0.499

Salonika and Athens are divided into 10 and 40 contiguous, well-defined sub-strata respectively.

A rotation system comprising six waves is used. Each sampling unit is kept in the sample for six consecutive quarters.

Weighting procedure

When a household fails to respond, it is replaced by the next household on the list.

No stratification is carried out *a posteriori*.

$\lambda = M/m$ is the weighting for this stratum, where M is the total number of households in each main stratum (estimated on the basis of the previous census) and m is the number of households in this stratum.

Thus, M_{hi} is the number of households in each i^{th} locality selected in each h^{th} sub-stratum, with P_{hi} the probability of selection. The number of households, m_{hi} , which have to be selected in this unit is determined by:

$$\lambda_{hi} = M_{hi}/m_{hi} \quad \text{where } \lambda_{hi} = \lambda P_{hi} \pi_h$$

where π_h is the number of localities selected in the h^{th} stratum.

Thus, the estimator of each characteristic Y for the main strata is calculated as:

$$Y = \lambda(\sum \sum \sum y_{hij})$$

Data collection

All the information is collected by means of face-to-face interviews (CAPI).

The field staff comprises 560 interviewers.

48% of the interviews were carried out by authorised third parties.

The response rate is approximately 90-92%. One-fifth of non-responses are refusals and the remainder are due to difficulties contacting the household.

SPAIN

General

Since 1996 the survey is compulsory as it was included in the yearly Statistical Program.

The survey produces quarterly results. Since 1999 the reference weeks are distributed uniformly over all the year.

The population residing in private households is covered, including servants; persons living in collective households and persons who are temporarily absent are sampled via the parents living in private household. Foreign nationals are included in the resident population if they have lived or intend to live in Spain for more than one year.

The household concept used is that of the "dwelling household".

Sampling plan

The sample size is 65 000 households, which represents an average survey rate of 0.5%.

The sampling unit is the postal address.

This entails a two-level survey with stratification of the primary units.

The primary sampling units are the census sections and the secondary sampling units are private dwellings.

Stratification is carried out in each primary unit, taking into account the province and the degree of urbanisation of the municipality. The strata thus obtained are subdivided into a maximum of nine sub-strata using information (obtained from the previous census) on the predominant socio-economic status of the population in the section.

A rotation system comprising six waves is used. Dwellings remain in the sample for six successive quarters. The selected statistical sections are not subject to rotation but new primary units are selected on the basis of

census or municipal registers information. Each quarter, the existing household sample in one-sixth of the sampled sections is replaced by a new sample.

Weighting procedure

Every quarter, population projections by age group (0-15 years and 16 years+) and NUTS III region are made. Projections by age and region are distributed by stratum in proportion to the population of each stratum. In each stratum, age group and region, the weighting is determined by the ratio of the projection to the sample size.

Data collection

All the information is collected by interview. The first interviews are personal interviews. Interviews in the second and subsequent waves are carried out by telephone, except when the family wants a personal interview or there is no telephone. Since the fourth quarter 1997 all interviews are done with the help of portable computers.

The field staff comprises 350 persons.

59% of the interviews were carried out by authorised third parties.

The response rate is 90%, with 40% of non-responses being due to refusals.

FRANCE

General

Participation in the survey is compulsory.

The survey is carried out in January-February of each year and the reference weeks are concentrated during a 6-week period.

The survey covers only Metropolitan France.

Only private households are included. The survey also covers part of the population living in collective households and some persons who are counted separately, insofar as they have family ties with ordinary households.

The resident population comprises persons living on French territory.

The household concept used is that of the "dwelling household".

Sampling plan

The sample is geographical, comprising areas from all of Metropolitan France.

The sample size is 75 000 households, which represents an average survey rate of 0.33%.

The sampling unit is the dwelling.

The survey is performed at several levels, using rural cantons and urban units as primary units.

The secondary sampling units are the communes in rural cantons and urban areas, including those with fewer than 10 000 inhabitants and groups of census districts, generally "cadastral sections" in urban areas with more than 10 000 inhabitants.

The primary units were stratified by crossing 21 regions and 10 categories of commune.

For the second level, in the rural cantons and the urban units with fewer than 10 000 inhabitants, in each primary unit sample, communes with fewer than 160 dwellings were combined with adjoining communes. A commune (or group of communes) was then drawn with a probability proportional to the number of dwellings.

In each urban sample with more than 10 000 inhabitants, a list of census districts was drawn up, showing the number of dwellings. After a calculation of the quotient between the number of dwellings in the urban unit and the number of areas to be drawn there, districts were segmented in as many portions and a sample district in proportion to the number of houses was drawn in each portion. The same principle was applied to urban areas with more than 100 000 inhabitants.

The final level of sampling consists in cutting out the secondary unit in areas with between about 80 to 160 dwellings according to the strata.

The annual survey is structured in three waves. One-third of the structure is renewed each year.

Weighting procedure

Each of the three sub-samples (new, intermediate status and departures) is adjusted in line with the population pyramid at the time of the survey, by sex and five-year age group.

During the second phase, a method known as the "raking ratio" is used to adjust the weighting of each household so that the survey estimates agree with independent demographic estimates by sex and five-year

age group. This method ensures that analyses at the level of individuals and households yield consistent results.

Data collection

Interviews are carried out on a face-to-face basis with the help of portable computers (CAPI). The Business Register (SIRENE) is also used as a source of information.

The field staff comprises 850 persons.

30% of the interviews were carried out by authorised third parties.

The response rate is 89.2%, with 33% of non-responses being due to refusals.

IRELAND

General

There is no specific legislation making it compulsory to provide information for the survey. Participation is therefore voluntary.

All the regions are covered.

Only private households are included.

The survey is a continuous one, providing quarterly results.

The population comprises persons who usually reside on Irish territory.

The private household is made up either of persons living alone or of two or more persons, whether or not of the same family, usually occupying the same dwelling and sharing a joint budget.

Sampling plan

The sample size is 39 000 households, representing an average survey rate of 3.3%.

The sampling unit is the household.

The survey base for the primary units is provided by the 1996 census. A list of dwellings was drawn up by visual enumeration during the summer of 1997 and update by the investigators every quarter.

Strata are formed by breaking the counties down by degree of urbanisation. The sample is drawn in two stages.

The quarterly survey is structured in five waves. One-fifth of the sample is renewed each quarter.

Weighting procedure

The sample is stratified *a posteriori* by NUTS III region, age group and sex. Independent demographic estimates are used for the stratification.

The weightings are calculated using the inverse of the probability of selection after adjustment to the population pyramid by sex and age group and on population distribution by NUTS III region.

Data collection

Interviews are carried out on a face-to-face basis with the help of portable computers (CAPI). All the information is obtained by interview.

The field staff comprises 160 persons (150 interviewers and 10 coordinators).

37.6% of the interviews were carried out by authorised third parties.

The response rate is 92%, with 56% of non-responses being due to refusals.

ITALY

General

The law compels persons questioned to provide the information required for the purposes of the survey. Participation in the survey is therefore compulsory.

All 103 provinces are covered.

Only private households are taken included.

A single reference week is used in each quarter.

The resident population is that recorded in the Population Registers of Italian communes.

The private household is made up either of persons living alone or of two or more persons, whether or not of the same family, usually occupying the same dwelling and sharing a joint budget.

Sampling plan

The sample size is 75 173 households, giving an average survey rate of 0.36%.

The sampling unit is the household.

The survey base for the primary units is provided by the communal Registers.

Stratification of the municipalities in each NUTS II region is based on the population of the communes.

The households are rotated according to a 2-2-2 rotation plan. Households are interviewed during two consecutive quarters. After a two-quarter interval, they are again interviewed twice in the corresponding two quarters of the following year.

Weighting procedure

The weighting procedure is based on a two phase process. At first the base weights are obtained as the reciprocal of the inclusion probability of the sampling units. Then the final weights are obtained adjusting the base weights to the distribution of population by sex and five year age group at NUTS II region level. Independent demographic estimates are used for the post-stratification.

This procedure is applied iteratively to ensure that all members of a given household have the same final weight.

Data collection

Interviews are carried out on a face-to-face basis.

The survey does not use complementary data from other sources.

The field staff comprises 2 680 persons.

28.5% of the interviews were carried out by authorised third parties.

The response rate is 95.1%, with 18.9% of non-responses being due to refusals and 67.4% to difficulties contacting the household.

LUXEMBOURG

General

There is no specific legislation making it compulsory to provide information for the survey. Participation is therefore voluntary.

The survey covers only private households.

The survey yields annual results. All the interviews refer to the same reference week.

The resident population comprises persons registered as residing in one of the communes.

The household is defined as persons living in the same household, other than subtenants and military personnel returning home at the weekend.

Sampling plan

The sample size is 5 500 households, giving an average survey rate of 5%.

The survey base is the central population register.

The sampling plan comprises only one stage. The sampling unit is the household.

No stratification is carried out.

A simple random sample is drawn.

A quarter of the sample is preserved from one year to the next in order to satisfy EU requirements.

Weighting procedure

The *a posteriori* stratification variables are age group, sex, nationality (Luxembourg nationals/foreign nationals) and household size. The weightings are a function of the pattern of settlement and are updated according to the *a posteriori* stratification criteria.

Data collection

Interviews are carried out on a face-to-face basis.

The survey does not use complementary data from other sources.

The field staff comprises 150 persons.

55% of the interviews were carried out by authorised third parties.

The response rate is 78%, with 42% of non-responses being due to refusals and 58% to difficulties contacting the household.

THE NETHERLANDS

General

There is no specific legislation making it compulsory to provide information for the survey. Participation is therefore voluntary.

The survey covers only private households.

The reference weeks are distributed throughout the year and the results transmitted for the Community survey are those for the first five months of the year.

The resident population comprises persons residing in the Netherlands.

The private household comprises either persons living alone or two or more persons, whether or not they are of the same family, who usually occupy the same dwelling and share a joint budget.

Sampling plan

The sample size is 60 000 addresses, an average survey rate of 1%.

The sampling unit is the household.

The survey base is a list of all addresses drawn up by the postal services. All institutions are eliminated from the sample. The file also contains information on the number of letter boxes at each address, i.e. the number of households which live there.

The sampling plan comprises three stages:

- a) primary sampling units: the municipalities;
- b) secondary sampling units: addresses;
- c) tertiary sampling units: households.

Municipalities are selected with a probability proportional to their population. All municipalities with a population of more than 18 000 persons (of which there are about 200), are permanently represented in the survey.

Addresses are selected systematically in a mailing list sorted by postal code. Addresses with more than one letter box, i.e. which include more than one household, are over-sampled, with a double probability of being selected.

If a selected address includes only one household, it is questioned. If the address includes more than one household, only half is questioned. This makes it possible to increase the effectiveness of the survey by reducing bunching.

66 strata are defined using cross classification based on 40 "Corop" regions and 18 employment-exchange regions.

Weighting procedure

A posteriori stratification in two stages is applied, using independent demographic information.

The first stage corrects differences in the response rates between municipalities.

The second stage uses a linear weighting method in which each member of the household has the same weight. Three *a posteriori* stratifications are used:

- first, a detailed breakdown by region and a broad breakdown by age, sex and marital status;
- secondly, a broad breakdown by region and a detailed breakdown by age, sex and marital status;
- finally, a broad breakdown of region by age, sex, nationality (Dutch/other).

Data collection

Interviews are carried out on a face-to-face basis with the help of portable computers (CAPI). Surveys of businesses are used as sources of data on working hours.

The field staff comprises 550 persons.

35% of the interviews were carried out by authorised third parties.

The response rate is 55-60%, with 60% of non-responses being due to refusals.

AUSTRIA

General

Regulation is minimal. A list of subjects determines the basic questionnaire and the survey periodicity. This permits the combination of the basic questions with additional, special programmes. Until 1999 participation is compulsory for the basic programme but optional for the additional, special programme. Since 2000, because of the new Federal Law there must be either a legal obligation (EU or national) or commitment by a funding agency.

Only private households are covered.

The survey provides quarterly results. The reference weeks are the first three weeks of the last month of each quarter.

The resident population comprises persons who have their main residence on Austrian territory during the reference week.

A private household is made up either of persons living alone or of two or more persons, whether or not of the same family, who usually occupy the same dwelling and share a common budget.

Sampling plan

The survey rate is 0.8%, which gives a sample of about 33000 houses.

The sampling unit is the dwelling. All the households in the selected dwellings are sampled.

The survey base is the census dwellings and houses, updated to take account of newly constructed dwellings.

A stratification was carried out within each *Land* using data obtained from the census on the number of occupants, size, period of construction and amenities.

A rotation system comprising eight waves is used. Each dwelling is kept in the sample for two years and one-eighth of the sample is replaced each quarter.

Weighting procedure

The extrapolated population is based on independent demographic estimates by *Bundesland*, sex and age, an additional constraint being that the share of foreign nationals in the total population must tally with the latest demographic estimates. An iterative process is applied to ensure that all members of a given household have an equal weighting.

Data collection

The Community LFS is carried out as part of the quarterly microcensus.

Interviews are carried out on a face-to-face basis.

The survey does not use complementary data from other sources.

The field staff comprises 1 215 persons.

Approximately 46% of the interviews were carried out by authorised third parties (interviewing other adult members of the household).

The response rate is about 72%; only 4.1% of non-responses being due to refusals, 58.2% to difficulties contacting the household and the remaining 38.4% to dwellings which are no longer inhabited, holiday residences or incomplete addresses.

PORTUGAL

General

Participation in the survey is compulsory (in accordance with Law No 6/89, *Sistema Estatístico Nacional*, of April 1989).

All the geographical territory of Portugal is covered, i.e. mainland Portugal, Madeira and the Azores.

Only private households are covered, although the survey also covers part of the population living in collective households and who represent a potential for the labour market, insofar as they have family links with the private households (national servicemen or students).

The survey is a continuous one which yields quarterly results.

The resident population is that residing in a private household during the reference week. Individuals absent for short periods of time and not occupying another housing permanently are also included.

A private household is made up either of persons living alone or of two or more persons, whether or not they are of the same family, who usually occupy the same dwelling and share a common budget.

Sampling plan

The sample size is 20 000 households, which represents a survey rate of 0.68%.

The survey base is a "mother sample" based on the results of the previous census.

The "mother sample" is constructed as follows:

The primary sampling units are *freguesias* (communes). Information on the number of dwellings in each *freguesia* is provided by the 1991 census.

Taking into account the "geographical spatial reference framework", secondary sampling units are selected.

These are the statistical sections used at the time of the previous census. Each statistical section comprises about 300 dwellings.

The LFS sample is a subsample of the "mother sample".

The tertiary sampling units are therefore dwellings.

The sample is stratified according to seven NUTS II regions. The survey rate differs from one region to another so as to satisfy the requirements of the EU as regards errors.

In the first phase of sampling, the municipalities in each region are chained and the *freguesias* which constitute them are arranged alphabetically. The number of voters in each *freguesia* is known. A systematic sample is drawn from the list of *freguesias* with a constant sampling interval in terms of voters. Thus, *freguesias* with fewer voters than the sampling interval are sampled with a probability proportional to the number of voters within a section of *freguesias* selected, while large *freguesias* are selected with a probability proportional to the number of voters.

In the second phase, within the *freguesias*, the statistical sections are selected with a probability proportional to the number of dwellings. Sections are selected in the "mother sample", which remains fixed over time.

In the third phase, carried out from the "mother sample", a number of adjacent dwellings in each section of the reference sample are selected. The number of dwellings sampled in each section is calculated so that the sample is self-weighting within the regions.

A rotation system comprising six waves is used. Houses are kept in the sample for six consecutive quarters before being replaced by an identical number of houses in the same statistical section. One-sixth of the sample is replaced each quarter.

Weighting procedure

A posteriori stratification is carried out by sex and age group. After adjustment for the different probability of sampling between the regions, the results are extrapolated to the total population.

Data collection

Interviews are carried out on a face-to-face basis with the help of portable computers (CAPI). All information is obtained by interview.

The field staff comprises 160 persons.

55.9% of the interviews were carried out by authorised third parties.

The response rate is 90.3%, with one-fifth of non-responses being due to refusals.

FINLAND

General

Participation in the survey is voluntary.

The survey is a monthly one, and a week in each month is chosen as the reference week.

The survey provides monthly, quarterly and annual results.

The survey covers private and collective households. Persons living in collective households are also recorded in the Central Population Register and are therefore sampled as well as persons living in private households.

The resident population comprises persons who, according to the Population Register, were legally domiciled in Finland on 31 December of the year preceding the survey. Persons temporarily absent from the country are included, as are foreign nationals who intend to reside in Finland for at least a year. Asylum-seekers are not legally resident until such time as their application is granted. Members of the diplomatic corps and their families are not members of the resident population.

No information on household structure is collected.

Sampling plan

The sampling unit is the individual. The survey base is provided by the Central Population Register. The sample comprises 12500 persons per month, which corresponds to a survey rate of 0.3%.

Respondents are questioned at quarterly intervals for three successive quarters and then, after a six-month interval, for two further consecutive quarters.

Weighting procedure

A posteriori stratification at one level is performed by sex, five-year age group and NUTS III region (22 regions). Information on job applicants obtained from the Ministry of Employment is also used as a post-

stratification variable (eight categories).

The data are limited to the aggregates of the central population register.

Data collection

95% of the interviews are carried out by telephone, using portable computers (CATI). Demographic information (sex, year of birth, marital status, nationality) and level of education, training and the year of completion are variables obtained from administrative sources (Population Register).

The field staff comprises 170 persons.

4% of the interviews were carried out by authorised third parties.

The response rate for wave 1 is 85.2%, with 40% of non-responses being due to refusals. The total response rate is 85.8 % with 62 % of non-responses being due to refusals.

SWEDEN

General

Participation in the survey is voluntary.

The reference weeks are distributed uniformly throughout the year and the survey provides monthly, quarterly and annual results.

Through sampling of individuals persons living in both private and collective households are covered. Persons living in a collective household are also recorded in the Central Population Register and are therefore sampled as well as persons living in private households.

The resident population for the purposes of the survey comprises persons between the ages of 16 and 74 who are domiciled in Sweden according to the Population Register.

No information on household structure is collected.

Sampling plan

The sampling unit is the individual. Statistics Sweden's Register of the Total Population (RTB) is the survey base.

The sample size is 17 000 individuals per month, which corresponds to a survey rate of 0.3%.

The population is stratified by sex, region, nationality (Swedish/foreign) and employment status (employed/unemployed) according to the Register of Employment (ARE), which gives a total of 192 strata.

A systematic sample of the RTB register, sorted by age, is drawn from each stratum. This produces a result similar to stratification by age. The sample is drawn at the beginning of each year, but is updated each month to take account of deaths, changes of address and changes in marital status.

Individuals are kept in the sample for two years and are questioned eight times, at three-monthly intervals. Samples are independent for a consecutive three-month period. One-eighth of the sample is replaced every three months.

Weighting procedure

Totals are calculated taking into account the probability of selection. The estimate is based on two types of a *posteriori* stratification, depending on whether the interviewees are employed or unemployed.

To estimate the number of unemployed, a *posteriori* stratification is carried out by sex, age group (10 and 20 years) and employment status (employed or unemployed) according to the Register of Unemployment.

To estimate the number of persons in employment, and those temporarily absent from work, a *posteriori* stratification of the sample and population is carried out by sex, five-year age group and branch of activity (eight branches in all). 147 strata are obtained in this way.

Data collection

Interviews are carried out by telephone, using portable computers (CATI). Demographic information (sex, age, nationality) and the level of educational attainment are obtained from administrative sources (Population Register).

The field staff comprises 140 persons.

3.0% of the interviews were carried out by authorised third parties.

The response rate is 84.9%, with 35.1% of non-responses being due to refusals and 62.9% to difficulties contacting the household.

UNITED KINGDOM

General

The survey covers private households, including persons who are temporarily absent. Students living in halls of residence, etc. are sampled via their parents living in private households. In Great Britain, an additional sample is drawn from among persons living in National Health Service /Hospital Trust accommodation.

The year is divided into quarters of 13 weeks: winter (December to February), spring (March to May - useful for results at EU level), summer (June to August) and autumn (September to November). For each of these periods, the reference weeks are distributed uniformly over the 13 weeks.

The resident population comprises persons who regard the sample address as their main address. Persons who have lived in the dwelling for more than six consecutive months are also a member of the resident population even if they do not regard this as their principal dwelling. Persons absent for more than six months are not regarded as a member of the resident population.

A private household comprises one or more persons whose main residence is the same dwelling and/or who share at least one meal per day. Students aged 16+ who live in a collective household but which return to their parents for the holidays are also regarded as being a member of their parents' household.

Sampling plan

The set sample size is 68 250 households per quarter.

The survey unit is the postal address (the telephone number in the far north of Scotland). For most of Great Britain, the survey base is the Royal Mail's PAF (Postcode Address File), a database of all addresses receiving mail. The list is limited to addresses receiving fewer than 25 items of post per day, so as exclude businesses. Because of the very low population density in the far north of Scotland (north of the Caledonian Canal), interviews are carried out by telephone because face-to-face interviews would be too expensive, and telephone directories are used as sampling frames. In Northern Ireland, the *Rating and Valuation Lists* (which serves for the administration of land taxes) is used. Most of Great Britain constitutes one stratum, while the far north of Scotland forms a separate stratum and Northern Ireland three strata: Belfast and eastern and western Northern Ireland.

In Great Britain, a systematic sample is drawn each quarter from the three sampling bases, using a sampling interval of 1 440 units. This yields 16 600 PAF addresses, 75 telephone numbers for the north of Scotland and 42 units of National Health Service housing. As the PAF is broken down geographically, the systematic sampling produces a pseudo-stratification effect which ensures that the sample is representative at regional level. In Northern Ireland, a simple random sample is drawn from each of the three strata, giving a 2600 addresses in all.

A rotation system comprising five waves is used. Respondents are questioned five times at 13-week intervals and one-fifth of the sample is replaced each quarter.

Weighting procedure

The adjustment procedure is based on an three-stage *a posteriori* stratification. In each case, estimates are based on independent demographic estimates.

a) The stratification variable for the first stage is the *Local Authority District*. This stage makes it possible to make adjustments for different rates of non-response in the various local authority areas and ensures that the results are geographically representative.

b) The second-stage variables are sex and age group (0-15, each year of age in the 16-24 group and 25+). This stratification is intended to ensure that the age profile of the important group of the 16-24 year olds is correct at national level.

c) The variables in the third stage are region, sex and five-year age group.

The three stages are applied by means of an iterative procedure designed to ensure that the estimates are consistent with the stratification variable sets.

Data collection

Interviews are carried out on a face-to-face basis with the help of portable computers (CAPI) for the interviews in the first wave. In the far north of Scotland (north of the Caledonian Canal) and for interviews in the second to fifth waves where ever possible, interviews are carried out by telephone (CATI). All information is obtained by interview.

The field staff comprises 420 persons.

32% of the interviews were carried out by authorised third parties.

The response rate is 78% for the first wave, with 72% of non-responses being due to refusals.

Table 2 – Sample design and data collection

	B	DK	D	EL	E	F	IRL	I
Sample design								
Collective household sampled?	no	yes	yes except for military quarters	no	yes	no	no	no
Frequency of the results	Annual and quarterly	quarterly	annual	quarterly	quarterly	annual	quarterly	quarterly
Reference week	evenly spread	evenly spread	single	evenly spread	Evenly spread	evenly spread during a month	evenly spread	multiple-one in each quarter
Basis of sampling frame	Population Register	Population Register	Census 1987 + Population Register	Census	Census 1991	Census	Census 1986	Population Register
Sample Unit	household	person	household	household	Dwelling	dwelling	household	household
Overall sample rate	1.2%	0.40%	0.45%	0.87%	0.50%	0.33%	3.30%	0.36%
Size of the sample	47840 households	15 600 persons	150 000 households	30 000 households	65 000 households	75 000 households	39 000 households	75 173 households
Stratification	yes	yes	yes	yes	Yes	yes	yes	yes
Variables used for the stratification	region	registered unemployment	region	region, urbanisation	region, urbanisation, sociol-economic status	region, sampling districts	region, urbanisation	region, urbanisation
Rotation scheme	2 waves	3 waves	4 waves	6 waves	6 waves	3 waves	5 waves	2-2-2
Post stratification	yes	yes	yes	no	Yes	yes	yes	yes
Variables of post stratification	sex, age, region	sex, age group, income, sector of activity, vocational education, registered unemployment	sex, region, nationality	--	age, region	sex, age	sex, age, region	sex, age group, region
Data collection								
Mode of Data collection	face to face interview	CATI	Written answers + face to face interview CAPI	face to face interview	CAPI and CATI	CAPI	CAPI	Face to face interview
Is the information exclusively obtained by interview	yes	no	yes	yes	Yes	no	yes	yes
Other sources of information	--	Register	--	--	--	Business register	--	--
Field staff (number)	350	50	7000	560	350	850	160	2680
% of proxy interviews	-	1-2	--	48	59	30	38	29
Response rate (%)	84	70	98	90-92	90	89	92	95
% of refusals in total non-response	--	6-10	--	18-20	40	33	57	19
% of non-contacts in total non-response	--	--	--	80-82	60	67	44	67
Item non-response-imputation	no	no	yes	yes	Yes	no	no	yes

Table 2 – Sample design and data collection

L	NL	A	P	S	FIN	UK	
							Sample design
no	no	no	no	Yes (see text)	yes	yes	Collective household sampled?
annual	annual	annual and quarterly	quarterly	annual, quarterly and monthly	annual, quarterly and monthly	quarterly	Frequency of the results
single	evenly spread	multiple	evenly spread	Evenly spread	multiple-one in each month	evenly spread	Reference week
Population Register	Post office	Census	Census	Population Register	Population Register	Post office	Basis of sampling frame
household	household	dwelling	household	Person	person	address	Sample Unit
5.00%	1.00%	1.00%	0.68%	0.30%	0.32%	0.40%	Overall sample rate
8 500 households	60 000 address	31 500 address	20 000 households	17 000 persons	12500 persons	68 250 households	Size of the sample
no	yes	yes	yes	Yes	yes	yes	Stratification
--	region	region, type of dwelling	region	sex, region, nationality, employment status	region	region	Variables used for the stratification
none	none	8 waves	6 waves	8 waves	5 waves	5 waves	Rotation scheme
yes	yes	yes	yes	Yes	yes	yes	Post stratification
sex, age group, nationality, size of household	sex, age group, region, nationality, marital status	sex, age group, region, nationality	sex, age, region	sex, age group, sector of activity, registered unemployment	sex, age group, region, registered unemployment	sex, age group, region	Variables of post stratification
							Data collection
face to face interview	CAPI	face to face interview	CAPI	CATI	CAPI and CATI	CAPI and CATI	Mode of Data collection
yes	no	yes	yes	No	no	yes	Is the information exclusively obtained by interview
--	Business survey	--	--	Population Register	Population Register and Register of Completed Education and Degrees	--	Other sources of information
150	550	1 215	160	140	170	420	Field staff (number)
55	35	46	56	3	4	32	% of proxy interviews
78	55-60	72	90	85	86	78	Response rate (%)
42	60	42	20	35	62	72	% of refusals in total non-response
58	25	58	80	63	36	28	% of non-contacts in total non-response
no	no	yes	no	no	yes	yes	Item non-response-imputation

POPULATION AND HOUSEHOLDS

GRAPH 1: Activity rates by age group
(EU-15*, 1999)

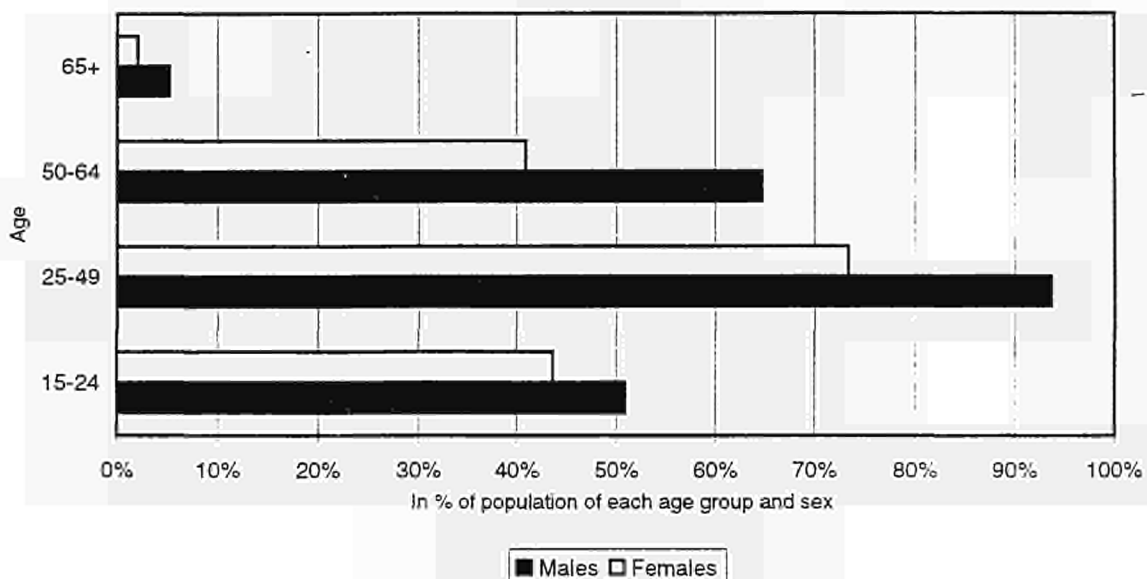

* Greece 1998

GRAPH 2: Activity rates of population aged 15-64 years old
(1999)

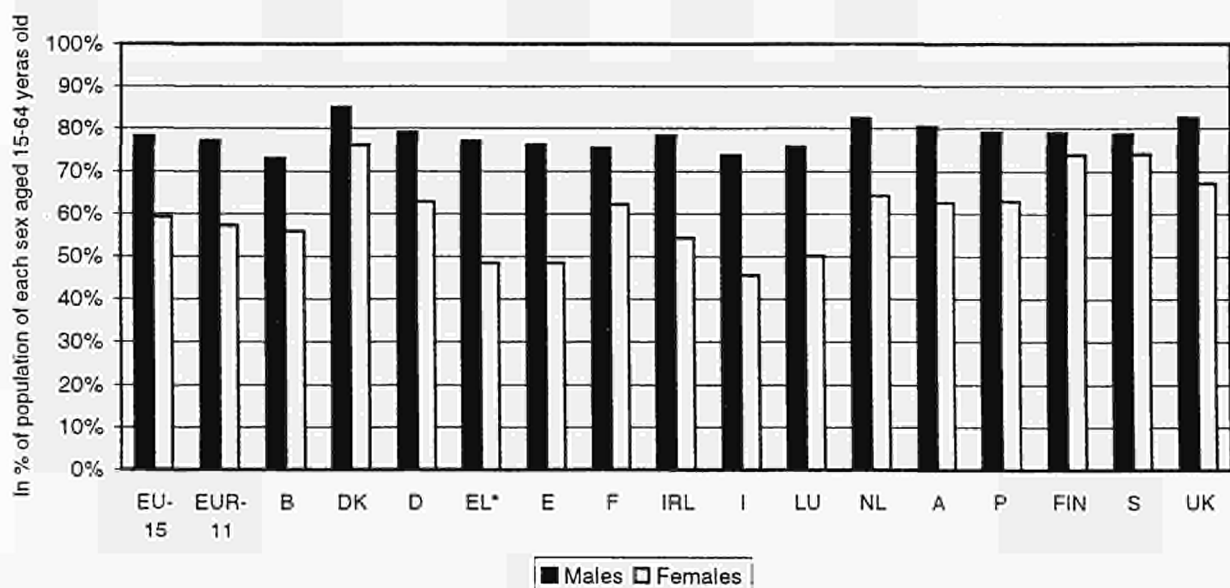

* 1998

GRAPH 3: Population aged 15-24 years old not in education and with low educational attainment level (1999)

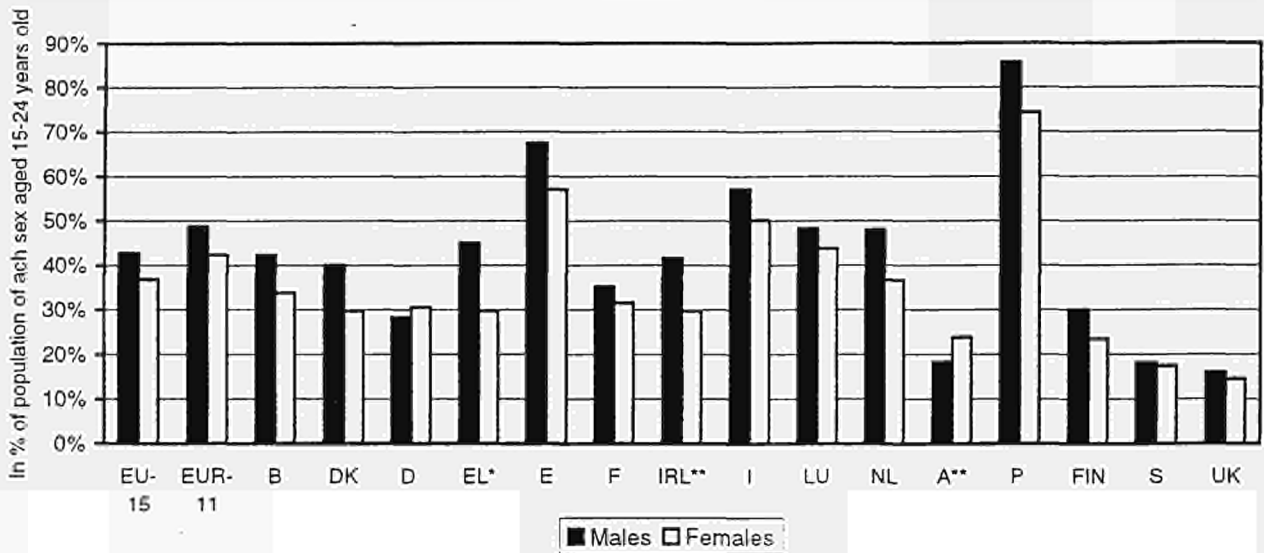

* 1998

** 1997

GRAPH 4: Composition of private households (1999)

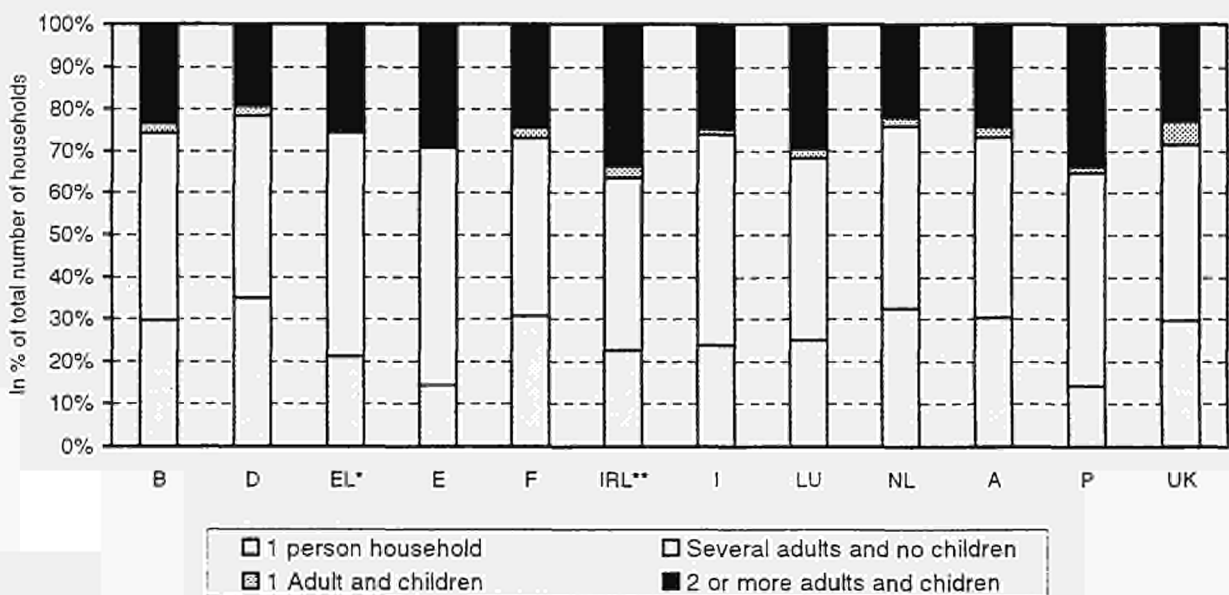

* 1998

** 1997

Table 1

Population by age groups

Thousands

	EU-15 ⁽²⁾	EUR-11	B	DK	D	EL ⁽¹⁾	E	F
Males and Females								
0-14 years	63 182	47 472	1 805	945	12 481	1 570	5 948	11 047
15-24 years	45 862	35 954	1 248	607	8 774	1 419	6 021	7 246
25-49 years	135 575	105 910	3 771	1 938	30 191	3 568	13 515	21 146
50-64 years	65 623	51 218	1 692	976	16 182	1 946	6 568	9 114
65 & + years	59 662	46 677	1 697	818	13 279	1 787	6 980	8 863
15-64 years	247 059	193 083	6 711	3 521	55 148	6 933	26 104	37 507
All ages	369 903	287 232	10 214	5 283	80 908	10 289	39 032	57 417
Males								
0-14 years	32 458	24 375	924	493	6 414	806	3 068	5 662
15-24 years	22 958	17 936	634	295	4 380	698	3 017	3 569
25-49 years	68 087	53 132	1 910	987	15 348	1 749	6 660	10 484
50-64 years	32 327	25 192	836	505	8 093	940	3 155	4 482
65 & + years	24 583	19 041	890	343	5 242	821	2 982	3 648
15-64 years	123 372	96 260	3 380	1 787	27 821	3 387	12 833	18 535
All ages	180 413	139 676	4 994	2 623	39 477	5 014	18 883	27 845
Females								
0-14 years	30 724	23 097	881	452	6 067	764	2 880	5 384
15-24 years	22 904	18 018	614	312	4 395	720	3 004	3 677
25-49 years	67 488	52 778	1 861	951	14 843	1 819	6 855	10 663
50-64 years	33 296	26 027	856	471	8 089	1 006	3 413	4 632
65 & + years	35 079	27 635	1 008	475	8 037	966	3 998	5 215
15-64 years	123 687	98 823	3 331	1 734	27 327	3 546	13 271	18 972
All ages	189 490	147 556	5 220	2 660	41 431	5 275	20 150	29 572
<i>Percentages of the Male and/or Female population</i>								
	EU-15 ⁽²⁾	EUR-11	B	DK	D	EL ⁽¹⁾	E	F
Males and Females								
0-14 years	17.1	16.5	17.7	17.9	15.4	15.3	15.2	19.2
15-24 years	12.4	12.5	12.2	11.5	10.8	13.8	15.4	12.6
25-49 years	36.7	36.9	36.9	36.7	37.3	34.7	34.6	36.8
50-64 years	17.7	17.8	16.6	18.5	20.0	18.9	16.8	15.9
65 & + years	16.1	16.3	16.6	15.5	16.4	17.4	17.9	15.4
15-64 years	66.8	67.2	65.7	66.6	68.2	67.4	66.9	65.3
Males								
0-14 years	18.0	17.5	18.5	18.8	16.2	16.1	16.2	20.3
15-24 years	12.7	12.8	12.7	11.3	11.1	13.9	16.0	12.8
25-49 years	37.7	38.0	38.2	37.6	38.9	34.9	35.3	37.6
50-64 years	17.9	18.0	16.7	19.3	20.5	18.7	16.7	16.1
65 & + years	13.6	13.6	13.8	13.1	13.3	16.4	15.8	13.1
15-64 years	68.4	68.9	67.7	68.1	70.5	67.6	68.0	66.6
Females								
0-14 years	16.2	15.7	16.9	17.0	14.6	14.5	14.3	18.2
15-24 years	12.1	12.2	11.8	11.7	10.6	13.7	14.9	12.4
25-49 years	35.6	35.8	35.7	35.7	35.8	34.5	34.0	36.1
50-64 years	17.6	17.6	16.4	17.7	19.5	19.1	16.9	15.7
65 & + years	18.5	18.7	19.3	17.8	19.4	18.3	19.8	17.6
15-64 years	65.3	65.6	63.8	65.2	66.0	67.2	65.9	64.2

⁽¹⁾ 1998.⁽²⁾ Greece 1998.

Table 1

Population by age groups

Thousands

IRL	I	L	NL	A	P	FIN	S	UK	
Males and Females									
829	8 332	79	2 915	1 379	1 709	947	1 636	11 559	0-14 years
658	6 958	49	1 871	916	1 576	638	1 022	6 859	15-24 years
1 308	21 213	171	6 124	3 071	3 549	1 850	3 027	21 132	25-49 years
528	10 464	66	2 652	1 357	1 646	950	1 615	9 867	50-64 years
422	9 945	60	1 983	1 198	1 493	756	1 542	8 839	65 & + years
2 494	38 634	285	10 646	5 344	6 771	3 438	5 665	37 858	15-64 years
3 745	56 912	424	15 544	7 921	9 973	5 142	8 844	58 256	All ages
Males									
426	4 286	40	1 489	706	875	483	840	5 945	0-14 years
335	3 463	25	950	453	793	317	522	3 506	15-24 years
650	10 648	87	3 107	1 546	1 746	946	1 544	10 676	25-49 years
266	5 093	32	1 336	664	768	464	812	4 878	50-64 years
182	4 080	26	835	455	615	287	654	3 724	65 & + years
1 252	19 204	144	5 394	2 663	3 306	1 728	2 879	19 059	15-64 years
1 859	27 571	210	7 718	3 824	4 797	2 498	4 373	28 728	All ages
Females									
404	4 046	39	1 425	673	834	464	796	5 614	0-14 years
323	3 495	24	921	462	784	321	500	3 353	15-24 years
657	10 565	84	3 017	1 526	1 803	904	1 483	10 457	25-49 years
262	5 370	33	1 315	693	878	486	803	4 988	50-64 years
240	5 865	33	1 148	743	878	469	889	5 115	65 & + years
1 242	19 431	141	5 253	2 681	3 465	1 711	2 786	18 798	15-64 years
1 886	29 341	214	7 826	4 097	5 176	2 644	4 471	29 528	All ages

Percentages of the Male and/or Female population

IRL	I	L	NL	A	P	FIN	S	UK	
Males and Females									
22.1	14.6	18.7	18.8	17.4	17.1	18.4	18.5	19.8	0-14 years
17.6	12.2	11.5	12.0	11.6	15.8	12.4	11.6	11.8	15-24 years
34.9	37.3	40.3	39.4	38.8	35.6	36.0	34.2	36.3	25-49 years
14.1	18.4	15.5	17.1	17.1	16.5	18.5	18.3	16.9	50-64 years
11.3	17.5	14.1	12.8	15.1	15.0	14.7	17.4	15.2	65 & + years
66.6	67.9	67.2	68.5	67.5	67.9	66.9	64.1	65.0	15-64 years
Males									
22.9	15.5	19.2	19.3	18.5	18.2	19.3	19.2	20.7	0-14 years
18.0	12.6	11.7	12.3	11.9	16.5	12.7	11.9	12.2	15-24 years
35.0	38.6	41.2	40.3	40.4	36.4	37.9	35.3	37.2	25-49 years
14.3	18.5	15.4	17.3	17.4	16.0	18.6	18.6	17.0	50-64 years
9.8	14.8	12.5	10.8	11.9	12.8	11.5	15.0	13.0	65 & + years
67.3	69.7	68.4	69.9	69.6	68.9	69.2	65.8	66.3	15-64 years
Females									
21.4	13.8	18.3	18.2	16.4	16.1	17.5	17.8	19.0	0-14 years
17.1	11.9	11.2	11.8	11.3	15.1	12.1	11.2	11.4	15-24 years
34.8	36.0	39.4	38.5	37.2	34.8	34.2	33.2	35.4	25-49 years
13.9	18.3	15.5	16.8	16.9	17.0	18.4	18.0	16.9	50-64 years
12.7	20.0	15.6	14.7	18.1	17.0	17.7	19.9	17.3	65 & + years
65.9	66.2	66.1	67.1	65.4	66.9	64.7	62.3	63.7	15-64 years

(1) 1998.

(2) Greece 1998.

Table 2⁽¹⁾

Population by nationality and age groups

*Percentages of the Male and/or Female population, Percentages of the Male and/or Female population with a given nationality

	EU-15 ⁽³⁾	EUR-11	B	DK	D	EL ⁽²⁾	E	F
Males and Females								
Nationals*	95.4	95.2	91.3	96.5	91.3	97.2	99.0	94.2
0-14 years	17.0	16.4	17.9	17.4	14.8	15.1	15.3	19.5
15-24 years	12.3	12.5	12.2	11.5	10.4	13.7	15.4	12.7
25-49 years	36.2	36.4	36.0	36.5	36.6	34.2	34.5	36.3
50-64 years	17.9	17.9	16.7	18.7	20.5	19.3	16.9	15.6
65 & + years	16.6	16.8	17.3	15.8	17.7	17.8	18.0	15.8
15-64 years	66.4	66.8	64.8	66.8	67.5	67.1	66.8	64.6
Non-Nationals/EU-Nationals*	1.4	1.5	5.3	0.7	2.3	0.2	0.4	1.9
0-14 years	11.0	12.3	9.7	13.2	15.3	.	8.4	8.6
15-24 years	10.3	10.1	9.8	.	12.0	.	8.4	6.4
25-49 years	46.1	46.5	48.3	53.6	46.7	58.9	40.3	43.7
50-64 years	21.5	21.2	18.7	22.7	20.8	.	25.7	25.4
65 & + years	11.0	10.0	13.5	(7.4)	5.3	.	17.2	15.8
15-64 years	77.9	77.7	76.8	79.4	79.4	81.7	74.4	75.6
Non-Nationals/NonEU-Nationals*	3.1	3.3	3.5	2.8	6.5	2.7	0.6	3.9
0-14 years	21.4	21.9	24.0	35.1	23.8	22.0	15.8	17.7
15-24 years	15.2	15.5	17.4	13.1	16.7	18.0	15.9	13.0
25-49 years	47.2	46.1	44.9	38.0	43.8	50.5	58.5	46.8
50-64 years	12.5	13.3	10.9	8.1	13.3	6.6	6.6	17.3
65 & + years	3.7	3.2	2.8	5.7	2.4	2.9	3.2	5.2
15-64 years	74.9	74.9	73.2	59.2	73.7	75.1	81.0	77.1
Males								
Nationals*	95.2	94.8	90.6	96.7	90.4	97.1	99.1	93.8
0-14 years	18.0	17.4	18.8	18.3	15.7	15.9	16.3	20.7
15-24 years	12.7	12.8	12.8	11.3	10.7	13.8	16.0	13.0
25-49 years	37.3	37.6	37.2	37.6	38.4	34.4	35.1	37.3
50-64 years	18.0	18.1	16.8	19.5	20.9	19.1	16.7	15.6
65 & + years	14.0	14.1	14.3	13.3	14.3	16.8	15.9	13.3
15-64 years	68.0	68.5	66.9	68.4	70.0	67.3	67.9	65.9
Non-Nationals/EU-Nationals*	1.5	1.6	5.7	0.6	2.5	0.1	0.4	2.1
0-14 years	11.2	12.1	10.0	.	15.1	.	9.4	8.3
15-24 years	9.6	9.5	9.3	.	10.9	.	9.7	6.0
25-49 years	46.0	46.2	49.4	52.2	46.0	.	35.1	44.4
50-64 years	22.5	22.5	19.0	(24.1)	22.6	.	27.7	25.9
65 & + years	10.8	9.8	12.3	.	5.5	.	18.1	15.5
15-64 years	78.1	78.2	77.7	79.3	79.4	(77.3)	72.5	76.2
Non-Nationals/NonEU-Nationals*	3.3	3.6	3.6	2.7	7.0	2.8	0.6	4.1
0-14 years	21.8	21.9	25.0	38.7	23.9	22.7	19.5	17.3
15-24 years	14.2	14.4	14.4	12.9	15.8	18.2	13.1	12.0
25-49 years	46.0	44.8	45.8	34.8	43.1	50.1	58.4	42.3
50-64 years	14.2	15.3	11.9	8.3	14.6	6.7	6.3	21.9
65 & + years	3.9	3.5	2.9	(5.3)	2.6	(2.3)	(2.8)	6.5
15-64 years	74.3	74.5	72.1	56.0	73.5	75.0	77.8	76.2
Females								
Nationals*	95.7	95.5	91.9	96.3	92.1	97.3	99.0	94.6
0-14 years	16.1	15.5	17.1	16.6	14.0	14.3	14.3	18.4
15-24 years	12.0	12.1	11.5	11.7	10.1	13.6	14.9	12.5
25-49 years	35.1	35.2	34.8	35.4	35.0	34.0	33.8	35.3
50-64 years	17.7	17.8	16.5	18.0	20.0	19.4	17.0	15.6
65 & + years	19.1	19.4	20.1	18.3	20.8	18.7	20.0	18.2
15-64 years	64.8	65.1	62.8	65.1	65.1	67.0	65.7	63.4
Non-Nationals/EU-Nationals*	1.3	1.3	4.8	0.8	2.0	0.2	0.4	1.8
0-14 years	10.9	12.6	9.4	(12.9)	15.5	.	7.4	8.9
15-24 years	11.0	10.7	10.3	.	13.4	.	7.2	7.0
25-49 years	46.2	46.8	46.9	54.6	47.5	67.8	45.5	43.0
50-64 years	20.5	19.6	18.4	21.6	18.6	.	23.7	24.8
65 & + years	11.3	10.2	14.9	.	5.0	.	16.3	16.2
15-64 years	77.7	77.2	75.7	79.5	79.5	84.1	76.3	74.8
Non-Nationals/NonEU-Nationals*	3.0	3.1	3.4	2.9	5.9	2.5	0.6	3.6
0-14 years	21.1	21.8	22.9	31.8	23.8	21.4	12.5	18.2
15-24 years	16.2	16.7	20.4	13.3	17.6	17.8	18.3	14.1
25-49 years	48.4	47.5	44.0	41.0	44.5	50.8	58.6	51.7
50-64 years	10.8	11.1	9.9	7.8	11.9	6.5	6.9	12.4
65 & + years	3.5	2.8	2.7	6.0	2.2	3.5	(3.6)	3.7
15-64 years	75.4	75.4	74.4	62.1	74.0	75.1	83.9	78.1

⁽¹⁾ These percentages were calculated using data from the NEWCRONOS table *p_ga_nws*.⁽²⁾ 1998.⁽³⁾ Greece 1998.

(1) Table 2

Population by nationality and age groups

* Percentages of the Male and/or Female population, Percentages of the Male and/or Female population with a given nationality

IRL	I	L	NL	A	P	FIN	S	UK	
Males and Females									
96.8	99.3	63.4	95.8	91.3	98.8	98.9	95.3	96.2	Nationals*
22.3	14.7	18.4	18.7	16.7	17.2	18.5	18.3	20.2	0-14 years
17.7	12.2	9.9	11.9	11.4	15.7	12.4	11.6	11.7	15-24 years
34.5	37.1	37.2	39.0	37.8	35.4	35.7	33.7	35.7	25-49 years
14.1	18.4	17.3	17.2	17.9	16.6	18.6	18.4	17.0	50-64 years
11.4	17.6	17.2	13.2	16.3	15.1	14.8	18.0	15.3	65 & + years
66.3	67.8	64.4	68.1	67.1	67.8	66.7	63.8	64.5	15-64 years
2.4	0.1	32.1	1.5	1.1	0.3	0.2	1.3	1.5	Non-Nationals/EU-Nationals*
14.7	.	18.8	12.9	11.8	(9.1)	.	.	6.3	0-14 years
13.6	(9.6)	14.0	8.8	8.0	25.4	.	9.1	11.9	15-24 years
47.3	56.7	45.4	52.6	54.7	44.3	60.7	52.0	42.9	25-49 years
15.7	18.8	13.0	19.5	13.6	(9.2)	.	29.0	22.3	50-64 years
8.7	(10.4)	8.7	6.2	12.0	(12.0)	.	9.8	16.5	65 & + years
76.6	85.1	72.5	80.9	76.3	78.9	79.3	90.2	77.1	15-64 years
0.8	0.6	4.5	2.7	7.6	0.8	0.9	3.4	2.3	Non-Nationals/NonEU-Nationals*
19.5	10.5	22.8	23.3	27.3	16.9	16.3	32.3	14.2	0-14 years
18.3	11.8	15.5	17.5	13.7	20.4	11.1	10.6	13.2	15-24 years
48.9	63.3	46.3	46.8	48.7	49.5	60.2	41.1	56.5	25-49 years
.	9.0	(7.3)	10.6	8.3	7.8	(8.8)	9.9	9.4	50-64 years
.	5.4	8.2	(1.9)	2.1	5.5	.	6.2	6.8	65 & + years
74.2	84.2	69.0	74.9	70.7	77.6	80.1	61.6	79.0	15-64 years
Males									
96.9	99.3	62.9	95.7	90.9	98.9	98.9	95.4	96.4	Nationals*
23.1	15.6	19.2	19.3	17.8	18.2	19.4	18.9	21.0	0-14 years
18.2	12.6	10.3	12.3	11.8	16.4	12.7	12.1	12.2	15-24 years
34.5	38.4	39.0	39.9	39.5	36.3	37.6	35.0	36.6	25-49 years
14.3	18.5	17.4	17.4	18.1	16.1	18.7	18.7	17.1	50-64 years
9.9	14.9	14.2	11.1	12.8	12.9	11.6	15.3	13.0	65 & + years
67.0	69.5	66.7	69.6	69.4	68.9	69.0	65.7	65.9	15-64 years
2.4	0.1	32.4	1.5	1.2	0.3	0.2	1.2	1.4	Non-Nationals/EU-Nationals*
14.1	.	18.5	10.8	10.9	.	.	.	7.4	0-14 years
11.6	.	13.9	8.7	9.6	(28.2)	.	.	10.9	15-24 years
49.1	55.2	45.3	48.8	55.8	44.4	(68.4)	47.8	44.4	25-49 years
17.0	(23.9)	12.7	25.0	13.6	.	.	33.5	20.7	50-64 years
(8.1)	.	9.7	(6.7)	10.2	.	.	.	16.6	65 & + years
77.8	90.2	71.9	82.5	78.9	78.3	84.9	89.6	76.0	15-64 years
0.7	0.6	4.7	2.7	7.9	0.8	0.9	3.3	2.2	Non-Nationals/NonEU-Nationals*
(19.0)	9.4	23.6	22.9	27.4	22.0	(15.8)	34.5	15.2	0-14 years
.	10.1	16.5	14.5	12.7	22.0	.	10.3	12.4	15-24 years
55.1	67.0	42.4	47.8	48.5	46.1	60.7	39.1	57.3	25-49 years
.	9.7	(8.1)	11.7	9.8	(6.5)	.	10.5	8.4	50-64 years
.	(3.6)	(9.5)	(3.1)	1.7	.	.	.	6.8	65 & + years
76.2	86.9	67.0	74.0	70.9	74.7	80.0	59.8	78.0	15-64 years
Females									
96.8	99.4	64.0	95.9	91.6	98.8	98.9	95.1	96.1	Nationals*
21.6	13.8	17.7	18.1	15.6	16.2	17.6	17.6	19.4	0-14 years
17.1	11.9	9.5	11.6	11.1	15.1	12.2	11.2	11.3	15-24 years
34.5	35.9	35.5	38.1	36.1	34.6	33.9	32.5	34.8	25-49 years
13.9	18.4	17.2	17.1	17.8	17.0	18.5	18.2	16.9	50-64 years
12.8	20.1	20.1	15.2	19.4	17.1	17.9	20.5	17.6	65 & + years
65.6	66.1	62.2	66.7	64.9	66.8	64.5	61.9	63.0	15-64 years
2.4	0.1	31.7	1.5	1.0	0.3	(0.1)	1.4	1.6	Non-Nationals/EU-Nationals*
15.3	.	19.2	15.0	12.8	.	.	.	5.4	0-14 years
15.5	.	14.1	8.9	6.2	(22.9)	.	.	12.8	15-24 years
45.4	58.0	45.6	56.4	53.4	44.2	.	55.6	41.6	25-49 years
14.5	(14.5)	13.4	13.9	13.6	.	.	25.2	23.6	50-64 years
(9.2)	.	7.7	(5.7)	14.0	.	.	.	16.5	65 & + years
75.5	80.8	73.1	79.3	73.3	79.4	.	90.7	78.0	15-64 years
0.8	0.5	4.3	2.7	7.4	0.8	1.0	3.5	2.3	Non-Nationals/NonEU-Nationals*
(19.9)	11.5	21.9	23.6	27.2	12.3	(16.6)	30.1	13.2	0-14 years
(21.5)	13.6	(14.4)	20.7	14.7	18.9	(11.7)	10.9	14.0	15-24 years
43.1	59.4	50.5	45.6	48.8	52.4	59.9	43.0	55.7	25-49 years
.	8.3	(6.4)	9.4	6.9	(8.9)	.	9.3	10.3	50-64 years
.	7.2	(6.8)	.	2.4	(7.5)	.	6.6	6.8	65 & + years
72.3	81.3	71.3	75.7	70.4	80.2	80.1	63.2	80.0	15-64 years

 (1) These percentages were calculated using data from the NEWCRONOS table *p_ga_nws*.

(2) 1998.

(3) Greece 1998.

Table 3⁽¹⁾

Population by marital status and age groups

*Percentages of the Male and/or Female population. Percentages of the Male and/or Female population with a given marital status

	EU-15 ⁽²⁾	EUR-11	B	DK	D	EL ⁽³⁾	E	F
	Males and Females							
Single*	41.7	41.4	40.4	45.0	38.0	37.3	42.6	45.6
0-24 years	69.1	68.6	72.5	64.6	67.4	75.1	70.9	68.9
25-49 years	25.5	25.8	22.6	30.5	27.2	21.3	23.3	26.5
50-64 years	2.8	2.9	2.7	2.8	3.1	2.0	2.6	2.6
65 & + years	2.5	2.7	2.2	2.1	2.4	1.6	3.1	2.0
Married*	47.0	47.9	48.8	42.6	49.7	53.7	48.8	43.4
0-24 years	1.2	1.3	1.2	0.7	1.4	1.9	0.9	1.1
25-49 years	49.6	49.8	52.5	47.6	48.5	47.4	47.7	50.4
50-64 years	29.8	29.7	27.0	32.5	31.9	30.1	28.9	28.1
65 & + years	19.4	19.3	19.4	19.2	18.2	20.6	22.5	20.5
Widowed*	6.9	7.0	7.1	6.3	7.5	7.4	6.8	6.3
0-24 years
25-49 years	4.3	4.5	6.6	3.3	4.2	4.7	4.3	4.7
50-64 years	16.8	17.3	14.1	15.7	18.1	20.6	16.6	15.7
65 & + years	78.8	78.1	79.3	81.0	77.7	74.5	79.1	79.7
Divorced*	4.4	3.7	3.8	6.1	4.9	1.6	1.8	4.7
0-24 years	0.5	0.5	.	.	0.3	.	0.8	(0.2)
25-49 years	55.1	54.6	46.2	40.3	53.2	56.8	62.2	55.5
50-64 years	31.8	32.3	35.0	38.8	33.1	29.7	27.4	32.0
65 & + years	12.5	12.7	18.4	20.7	13.3	12.7	9.5	12.3
	Males							
Single*	45.4	45.1	44.2	48.8	41.9	41.3	46.0	49.2
0-24 years	66.8	66.4	70.1	61.3	64.3	71.9	69.4	66.9
25-49 years	28.4	28.9	25.0	33.2	31.1	25.4	25.7	28.6
50-64 years	3.0	3.0	3.0	3.6	3.5	1.7	2.7	2.8
65 & + years	1.7	1.7	1.9	1.9	1.1	1.1	2.1	1.7
Married*	48.4	49.3	49.9	43.1	51.4	55.0	50.4	44.6
0-24 years	0.6	0.7	0.5	(0.3)	0.8	0.6	0.5	0.5
25-49 years	47.0	47.0	50.7	44.5	45.6	43.1	44.9	47.8
50-64 years	30.6	30.6	27.7	34.2	33.1	31.3	29.3	29.0
65 & + years	21.7	21.7	21.0	21.1	20.5	25.0	25.3	22.6
Widowed*	2.5	2.4	2.7	2.7	2.6	2.6	2.4	2.2
0-24 years
25-49 years	5.2	5.5	11.6	(4.0)	5.4	4.2	3.1	5.2
50-64 years	18.1	19.1	18.1	18.7	22.0	17.9	16.0	18.0
65 & + years	76.5	75.2	70.3	77.2	72.5	77.6	80.9	76.7
Divorced*	3.7	3.1	3.3	5.4	4.1	1.1	1.2	4.0
0-24 years
25-49 years	54.1	54.4	48.5	39.7	55.7	54.1	58.8	53.9
50-64 years	34.4	34.9	33.2	42.1	35.2	33.9	27.9	34.9
65 & + years	11.1	10.4	18.3	18.1	9.0	11.8	12.6	11.1
	Females							
Single*	38.2	37.8	36.8	41.2	34.2	33.5	39.4	42.2
0-24 years	71.7	71.2	75.4	68.5	70.9	78.9	72.5	71.0
25-49 years	22.2	22.3	19.8	27.3	22.6	16.5	20.7	24.2
50-64 years	2.6	2.8	2.3	1.9	2.7	2.4	2.6	2.4
65 & + years	3.5	3.7	2.5	2.4	3.8	2.2	4.2	2.4
Married*	45.7	46.6	47.7	42.2	48.0	52.5	47.3	42.2
0-24 years	1.8	1.9	1.8	1.1	2.0	3.2	1.3	1.6
25-49 years	52.2	52.6	54.2	50.8	51.5	51.8	50.5	52.9
50-64 years	29.0	28.7	26.3	30.8	30.7	28.9	28.4	27.2
65 & + years	17.0	16.8	17.7	17.3	15.8	16.2	19.7	18.4
Widowed*	11.1	11.3	11.2	9.8	12.2	11.9	11.0	10.2
0-24 years
25-49 years	4.1	4.3	5.4	3.1	3.9	4.8	4.5	4.5
50-64 years	16.5	16.9	13.2	14.9	17.3	21.2	16.8	15.2
65 & + years	79.3	78.8	81.3	82.1	78.8	73.9	78.7	80.3
Divorced*	5.1	4.3	4.3	6.9	5.6	2.1	2.3	5.4
0-24 years	0.7	0.6	.	.	0.4	.	(0.9)	(0.3)
25-49 years	55.8	54.7	44.5	40.7	51.5	58.0	63.8	56.6
50-64 years	30.0	30.4	36.3	36.3	31.7	27.7	27.2	30.0
65 & + years	13.5	14.2	18.5	22.7	16.4	13.1	8.0	13.2

⁽¹⁾ These percentages were calculated using data from the NEWCRONOS table *p_ga_ms*. Non responses to the variable MARITAL STATUS not considered.⁽²⁾ 1998.⁽³⁾ Greece 1998.

(1) Table 3

Population by marital status and age groups

*Percentages of the Male and/or Female population. Percentages of the Male and/or Female population with a given marital status

IRL	I	L	NL	A	P	FIN	S	UK	
Males and Females									
53.9	39.7	40.1	44.5	41.3	39.4	45.2	49.0	42.9	Single*
73.2	66.1	72.8	67.9	68.1	78.9	65.4	61.0	72.4	0-24 years
20.4	26.5	23.7	28.0	26.8	17.1	27.5	32.0	23.1	25-49 years
3.0	3.5	2.0	2.4	2.7	1.8	4.2	4.4	2.3	50-64 years
3.4	3.8	1.6	1.7	2.4	2.1	3.0	2.6	2.1	65 & + years
38.4	50.7	48.8	45.3	46.6	52.2	40.7	36.6	43.2	Married*
0.6	1.2	2.1	1.2	1.7	3.5	0.9	0.5	1.1	0-24 years
57.5	50.0	57.0	53.1	53.0	52.1	49.0	41.5	50.2	25-49 years
28.4	29.6	25.1	29.5	28.3	26.8	32.0	33.5	29.8	50-64 years
13.5	19.2	15.9	16.2	17.0	17.6	18.1	24.6	19.0	65 & + years
5.3	7.7	7.0	5.3	7.2	6.4	6.3	6.3	6.5	Widowed*
.	0.3	0-24 years
5.4	4.3	(5.0)	3.9	5.0	6.6	4.4	2.8	3.5	25-49 years
17.5	17.9	19.0	18.4	17.5	19.4	15.8	9.5	14.8	50-64 years
77.0	77.5	76.0	77.3	77.4	74.0	79.8	87.7	81.7	65 & + years
2.4	1.9	4.1	4.9	4.9	2.1	7.8	8.2	7.3	Divorced*
.	1.5	.	.	0.6	(1.4)	.	.	0.8	0-24 years
65.4	56.2	63.0	54.3	54.0	58.6	48.9	39.1	60.2	25-49 years
28.4	30.5	27.6	34.1	32.7	27.2	35.7	40.3	28.7	50-64 years
5.9	11.8	8.7	11.1	12.7	12.7	15.1	20.6	10.2	65 & + years
Males									
57.0	43.7	43.2	47.8	45.0	42.8	49.0	53.1	46.4	Single*
71.5	63.7	69.8	65.4	66.3	78.5	63.0	58.6	70.3	0-24 years
21.8	30.5	27.0	31.2	29.9	19.4	30.5	34.1	25.1	25-49 years
3.4	3.4	2.2	2.4	2.7	1.2	4.5	5.2	2.8	50-64 years
3.3	2.5	(1.0)	1.0	1.1	0.9	2.0	2.1	1.7	65 & + years
38.8	52.0	50.2	45.6	48.6	53.9	42.1	37.3	44.8	Married*
(0.3)	0.5	(1.4)	0.6	0.9	2.1	0.6	.	0.6	0-24 years
54.9	46.6	54.3	50.5	50.3	50.5	47.3	38.8	49.0	25-49 years
29.1	30.6	25.5	30.6	29.5	27.5	32.4	33.6	29.9	50-64 years
15.6	22.3	18.8	18.2	19.3	19.8	19.7	27.5	20.5	65 & + years
2.3	2.6	2.9	2.2	2.3	2.0	2.1	2.7	2.9	Widowed*
.	(0.5)	0-24 years
(7.8)	5.8	.	(5.2)	6.6	6.5	(6.4)	.	4.6	25-49 years
20.5	18.7	(17.3)	19.0	21.4	14.6	16.1	10.6	14.8	50-64 years
71.3	75.0	78.4	74.4	72.0	79.0	77.5	86.7	80.7	65 & + years
1.8	1.7	3.7	4.4	4.1	1.3	6.9	6.9	6.0	Divorced*
.	(1.0)	0.7	0-24 years
59.6	53.4	56.9	50.1	56.9	60.5	50.1	38.6	57.3	25-49 years
32.2	34.8	32.8	40.4	33.2	26.7	38.1	43.6	31.0	50-64 years
(7.9)	10.8	(9.9)	9.1	9.5	12.0	11.5	17.9	11.0	65 & + years
Females									
50.8	35.9	36.9	41.2	37.9	36.2	41.6	45.0	39.6	Single*
75.2	68.9	76.2	70.8	70.0	79.4	68.0	63.7	74.8	0-24 years
18.8	22.1	19.8	24.4	23.5	14.7	24.2	29.6	20.9	25-49 years
2.4	3.7	(1.7)	2.3	2.7	2.4	3.8	3.4	1.8	50-64 years
3.6	5.4	2.2	2.5	3.9	3.5	4.0	3.2	2.5	65 & + years
37.9	49.4	47.5	44.9	44.8	50.5	39.5	35.8	41.7	Married*
0.8	1.8	2.8	1.7	2.6	4.9	1.3	0.9	1.6	0-24 years
60.1	53.3	59.8	55.8	55.6	53.7	50.7	44.2	51.4	25-49 years
27.7	28.7	24.6	28.3	27.1	26.1	31.6	33.4	29.6	50-64 years
11.4	16.2	12.8	14.2	14.7	15.3	16.5	21.5	17.4	65 & + years
8.2	12.5	11.1	8.4	11.8	10.4	10.3	9.8	10.0	Widowed*
.	0.2	0-24 years
4.7	4.0	(5.2)	3.6	4.7	6.6	4.0	2.9	3.2	25-49 years
16.7	17.7	19.5	18.3	16.9	20.3	15.8	9.2	14.8	50-64 years
78.5	78.0	75.4	78.1	78.4	73.1	80.2	87.9	82.0	65 & + years
3.1	2.2	4.5	5.4	5.5	2.9	8.7	9.4	8.6	Divorced*
.	1.8	.	.	.	(1.7)	.	.	0.9	0-24 years
68.7	58.1	67.9	57.6	52.0	57.9	48.0	39.5	62.2	25-49 years
26.2	27.5	23.5	29.2	32.3	27.4	33.9	37.9	27.2	50-64 years
(4.7)	12.6	(7.7)	12.8	14.8	13.0	17.7	22.6	9.7	65 & + years

 (1) These percentages were calculated using data from the NEWCRONOS table *p_ga_ms*. Non responses to the variable MARITAL STATUS not considered.

(2) 1998.

(3) Greece 1998.

Table 4⁽¹⁾

Population, aged 15 years or more, by age groups and labour status

*Percentages of the Male and/or Female population aged 15 years or more, Percentages of the Male and/or Female population in a given age group

	EU-15 ⁽²⁾	EUR-11	B	DK	D	EL ⁽³⁾	E	F
Males and Females								
15-24 years*	15.0	15.0	14.8	14.0	12.8	16.3	18.2	15.6
Employed	38.7	35.6	25.5	66.0	46.2	28.1	29.2	26.5
Unemployed	8.6	8.7	7.4	7.3	4.5	11.9	12.2	9.6
Inactive	52.7	55.7	67.1	26.7	49.2	60.0	58.6	63.9
25-49 years*	44.2	44.2	44.8	44.7	44.1	40.9	40.9	45.6
Employed	76.5	75.6	79.2	85.3	79.1	71.8	67.1	77.8
Unemployed	7.1	7.7	6.5	3.7	6.8	7.5	11.3	9.6
Inactive	16.5	16.7	14.3	11.0	14.1	20.7	21.6	12.6
50-64 years*	21.4	21.4	20.1	22.5	23.6	22.3	19.9	19.7
Employed	48.6	45.4	38.5	65.5	48.2	45.9	43.1	47.0
Unemployed	4.0	4.2	2.3	3.1	6.6	2.1	4.6	4.4
Inactive	47.5	50.4	59.2	31.5	45.3	52.1	52.3	48.6
65 & + years*	19.5	19.5	20.2	18.8	19.4	20.5	21.1	19.1
Employed	3.3	2.8	1.9	1.9	2.6	6.3	1.7	1.1
Unemployed								
Inactive	96.7	97.1	98.1	98.1	97.4	93.6	98.3	98.9
15-64 years*	80.5	80.5	79.8	81.2	80.6	79.5	78.9	80.9
Employed	62.1	60.1	58.9	76.5	64.8	55.6	52.3	60.4
Unemployed	6.5	6.9	5.6	4.2	6.4	6.9	9.8	8.3
Inactive	31.4	32.9	35.4	19.4	28.8	37.5	37.9	31.2
Males								
15-24 years*	15.5	15.6	15.6	13.9	13.2	16.6	19.1	16.1
Employed	42.2	39.3	27.5	69.5	48.6	34.2	35.2	29.9
Unemployed	8.7	8.6	8.1	7.3	5.3	9.3	10.5	9.9
Inactive	49.1	52.1	64.5	23.3	46.1	56.5	54.2	60.2
25-49 years*	46.0	46.1	46.9	46.3	46.4	41.6	42.1	47.3
Employed	87.0	86.9	88.0	89.9	87.1	90.2	84.7	86.7
Unemployed	6.6	6.9	5.9	3.4	7.0	5.7	8.7	8.6
Inactive	6.4	6.2	6.1	6.7	5.9	4.2	6.6	4.7
50-64 years*	21.8	21.8	20.5	23.7	24.5	22.3	20.0	20.2
Employed	59.9	57.4	51.1	71.1	57.5	64.9	63.4	52.7
Unemployed	4.7	4.9	2.7	2.6	7.4	2.5	5.7	4.7
Inactive	35.4	37.7	46.2	26.3	35.1	32.6	30.8	42.5
65 & + years*	16.6	16.5	16.9	16.1	15.9	19.5	18.9	16.4
Employed	5.2	4.5	3.4	2.9	4.2	9.6	2.5	1.7
Unemployed								
Inactive	94.7	95.5	96.6	97.1	95.8	90.3	97.5	98.3
15-64 years*	83.4	83.5	83.1	83.9	84.1	80.5	81.1	83.6
Employed	71.6	70.3	67.5	81.2	72.4	71.6	67.8	67.5
Unemployed	6.5	6.7	5.5	3.8	6.8	5.5	8.4	7.9
Inactive	22.0	23.0	27.0	15.0	20.7	22.9	23.8	24.5
Females								
15-24 years*	14.4	14.5	14.1	14.1	12.4	16.0	17.4	15.2
Employed	35.1	31.9	23.4	62.8	43.9	22.2	23.1	23.3
Unemployed	8.5	8.8	6.8	7.3	3.7	14.4	13.9	9.2
Inactive	56.3	59.3	69.9	29.9	52.4	63.4	63.0	67.5
25-49 years*	42.5	42.4	42.9	43.1	42.0	40.3	39.7	44.1
Employed	65.9	64.3	70.1	80.5	70.8	54.2	50.0	69.1
Unemployed	7.5	8.4	7.1	4.1	6.6	9.3	13.8	10.6
Inactive	26.6	27.4	22.7	15.4	22.6	36.5	36.1	20.3
50-64 years*	21.0	20.9	19.7	21.3	22.9	22.3	19.8	19.2
Employed	37.6	33.8	26.2	59.5	38.9	28.1	24.3	41.5
Unemployed	3.3	3.6	2.0	3.5	5.7	1.7	3.5	4.1
Inactive	59.2	62.6	71.8	37.0	55.4	70.2	72.2	54.4
65 & + years*	22.1	22.2	23.2	21.5	22.7	21.4	23.2	21.6
Employed	2.0	1.7	0.9	1.2	1.6	3.5	1.0	0.6
Unemployed								
Inactive	98.0	98.3	99.1	98.7	98.4	96.4	99.0	99.4
15-64 years*	77.9	77.8	76.8	78.5	77.3	78.6	76.8	78.4
Employed	52.6	50.0	50.2	71.6	57.1	40.3	37.3	53.5
Unemployed	6.6	7.2	5.7	4.5	5.8	8.2	11.2	8.7
Inactive	40.9	42.8	44.0	23.9	37.1	51.5	51.5	37.8

(1) These percentages were calculated using data from the NEWCRONOS table *p_ga_mws*.

(2) 1998.

(3) Greece 1998.

(1) Table 4

Population, aged 15 years or more, by age groups and labour status

*Percentages of the Male and/or Female population aged 15 years or more. Percentages the Male and/or Female population in a given age group

IRL	I	L	NL	A	P	FIN	S	UK	
Males and Females									
22.6	14.3	14.1	14.8	14.0	19.1	15.2	14.2	14.7	15-24 years*
46.5	25.5	31.7	62.7	54.9	43.3	45.0	35.4	55.0	Employed
4.3	12.6	(2.3)	5.0	3.5	4.3	18.0	6.9	8.0	Unemployed
49.2	61.9	66.0	32.3	41.6	52.4	37.0	57.7	37.1	Inactive
44.8	43.7	49.5	48.5	46.9	42.9	44.1	42.0	45.3	25-49 years*
75.1	68.6	78.4	82.5	82.6	82.3	80.9	81.4	80.3	Employed
4.2	7.8	1.7	2.6	3.8	3.6	7.8	6.2	4.4	Unemployed
20.7	23.6	20.0	14.9	13.6	14.1	11.3	12.4	15.3	Inactive
18.1	21.5	19.1	21.0	20.7	19.9	22.6	22.4	21.1	50-64 years*
51.3	37.9	40.0	50.0	44.5	58.4	56.3	72.6	60.0	Employed
2.5	1.9	.	1.3	2.3	2.2	5.2	4.6	2.9	Unemployed
46.2	60.2	59.6	48.6	53.1	39.4	38.5	22.8	37.1	Inactive
14.5	20.5	17.3	15.7	18.3	18.1	18.0	21.4	18.9	65 & + years*
8.0	3.3	(1.1)	2.7	2.8	17.7	1.9	3.7	5.2	Employed
.	0.1	0.1	Unemployed
92.0	96.6	98.8	97.3	97.2	82.3	98.1	96.3	94.7	Inactive
85.5	79.5	82.7	84.3	81.7	81.9	82.0	78.6	81.1	15-64 years*
62.5	52.5	61.6	70.9	68.2	67.4	67.4	70.6	70.4	Employed
3.9	7.0	1.5	2.7	3.4	3.4	9.0	5.9	4.7	Unemployed
33.6	40.4	36.9	26.4	28.4	29.1	23.6	23.6	24.9	Inactive
Males									
23.4	14.9	14.5	15.3	14.5	20.2	15.8	14.8	15.4	15-24 years*
49.8	30.3	33.7	62.9	59.2	47.9	47.2	35.8	57.0	Employed
4.6	12.1	(2.2)	4.5	3.5	3.9	17.9	7.4	9.7	Unemployed
45.5	57.6	64.0	32.6	37.4	48.2	34.9	56.9	33.3	Inactive
45.4	45.7	50.9	49.9	49.6	44.5	47.0	43.7	46.9	25-49 years*
87.5	85.3	93.8	92.3	90.5	90.5	84.5	83.2	87.4	Employed
5.2	6.8	(1.3)	2.1	4.1	3.4	7.2	6.9	5.2	Unemployed
7.3	7.8	4.9	5.7	5.4	6.1	8.3	9.9	7.4	Inactive
18.6	21.9	19.1	21.5	21.3	19.6	23.0	23.0	21.4	50-64 years*
69.5	54.1	53.7	65.1	56.7	70.6	56.7	74.6	68.4	Employed
3.6	2.3	.	1.0	3.2	3.1	5.5	5.6	4.2	Unemployed
26.9	43.6	45.8	33.9	40.1	26.3	37.8	19.8	27.4	Inactive
12.7	17.5	15.4	13.4	14.6	15.7	14.3	18.5	16.3	65 & + years*
14.9	5.6	.	4.8	4.2	24.3	3.8	7.0	7.7	Employed
.	Unemployed
85.0	94.3	98.1	95.2	95.8	75.6	96.2	92.9	92.1	Inactive
87.3	82.5	84.6	86.6	85.4	84.3	85.7	81.5	83.7	15-64 years*
73.6	67.1	74.4	80.3	76.7	75.7	70.2	72.1	76.9	Employed
4.7	6.6	1.3	2.2	3.8	3.5	8.8	6.6	5.8	Unemployed
21.7	26.3	24.3	17.4	19.5	20.9	21.1	21.2	17.3	Inactive
Females									
21.8	13.8	13.7	14.4	13.5	18.0	14.7	13.6	14.0	15-24 years*
43.0	20.8	29.5	62.5	50.7	38.5	42.8	35.0	52.8	Employed
3.9	13.0	(2.4)	5.5	3.5	4.8	18.1	6.4	6.2	Unemployed
53.1	66.2	68.1	32.0	45.8	56.7	39.1	58.6	41.0	Inactive
44.3	41.8	48.2	47.1	44.6	41.5	41.5	40.4	43.7	25-49 years*
62.9	51.7	62.6	72.4	74.6	74.5	77.1	79.5	73.0	Employed
3.2	8.7	2.0	3.1	3.5	3.8	8.4	5.5	3.6	Unemployed
33.9	39.6	35.4	24.5	21.9	21.7	14.5	15.0	23.4	Inactive
17.7	21.2	19.0	20.5	20.2	20.2	22.3	21.9	20.9	50-64 years*
32.8	22.5	26.6	34.8	32.9	47.8	55.9	70.6	51.7	Employed
(1.4)	1.5	.	1.6	1.5	1.5	4.8	3.6	1.7	Unemployed
65.7	76.0	73.0	63.6	65.6	50.8	39.3	25.9	46.6	Inactive
16.2	23.2	19.1	17.9	21.7	20.2	21.5	24.2	21.4	65 & + years*
2.7	1.7	.	1.1	2.0	13.1	(0.8)	1.2	3.4	Employed
.	(0.1)	Unemployed
97.2	98.2	99.4	98.9	98.0	86.9	99.2	98.8	96.5	Inactive
83.8	76.8	80.9	82.1	78.3	79.8	78.5	75.8	78.6	15-64 years*
51.4	38.1	48.5	61.3	59.7	59.6	64.6	68.9	63.7	Employed
3.0	7.5	1.7	3.1	3.0	3.4	9.2	5.1	3.5	Unemployed
45.6	54.4	49.8	35.6	37.3	37.0	26.1	26.0	32.7	Inactive

 (1) These percentages were calculated using data from the NEWCRONOS table *p_ga_nws*.

(2) 1998.

(3) Greece 1998.

Table 5⁽¹⁾

Population, aged 15 years or more, by degree of urbanisation of residence and labour status

Percentages of the Male and/or Female population living in a given type of area

	EU-15 ⁽²⁾	EUR-11	B	DK	D	EL ⁽²⁾	E	F
Males and Females								
Densely Populated area								
Employed	50.5	48.9	45.1	63.1	51.6	44.6	43.2	49.5
Unemployed	5.7	6.1	5.6	3.7	5.5	6.6	8.0	7.6
Inactive	43.8	45.1	49.2	33.3	42.9	48.8	48.8	43.0
Intermediate Populated area								
Employed	52.0	50.0	50.1	63.5	53.9	47.2	42.1	49.7
Unemployed	4.4	4.7	3.2	3.0	4.0	4.6	8.1	6.5
Inactive	43.5	45.2	46.7	33.5	42.0	48.3	49.8	43.7
Thinly Populated area								
Employed	49.8	47.9	49.6	61.1	53.7	47.1	38.6	48.4
Unemployed	5.4	5.7	3.5	3.4	6.0	2.9	7.1	5.9
Inactive	44.8	46.3	46.9	35.5	40.3	50.0	54.3	45.7
Males								
Densely Populated area								
Employed	60.0	58.7	54.0	67.9	59.8	59.0	56.3	56.4
Unemployed	6.2	6.4	6.1	4.0	6.6	5.3	7.1	8.1
Inactive	33.8	34.8	39.9	28.1	33.5	35.7	36.6	35.5
Intermediate Populated area								
Employed	62.8	61.4	59.6	69.8	63.6	62.4	57.1	58.1
Unemployed	4.3	4.4	2.9	2.7	4.3	3.8	6.9	6.3
Inactive	32.9	34.1	37.6	27.5	32.1	33.8	36.0	35.6
Thinly Populated area								
Employed	59.6	58.4	60.0	68.2	62.8	59.6	53.0	56.4
Unemployed	5.2	5.4	2.7	3.0	6.1	2.6	6.4	5.2
Inactive	35.2	36.2	37.3	28.8	31.1	37.9	40.6	38.4
Females								
Densely Populated area								
Employed	41.9	40.0	37.2	58.4	44.0	31.6	31.5	43.2
Unemployed	5.2	5.7	5.1	3.4	4.5	7.7	8.8	7.1
Inactive	52.9	54.3	57.7	38.3	51.5	60.7	59.7	49.6
Intermediate Populated area								
Employed	41.9	39.4	40.8	57.4	44.8	32.6	28.2	42.2
Unemployed	4.5	5.0	3.5	3.2	3.8	5.3	9.3	6.8
Inactive	53.6	55.7	55.8	39.3	51.4	62.1	62.5	51.1
Thinly Populated area								
Employed	40.4	38.0	39.8	54.3	44.9	34.8	24.9	40.7
Unemployed	5.6	6.1	4.3	3.9	5.9	3.2	7.8	6.5
Inactive	54.0	56.0	55.9	41.9	49.2	62.0	67.3	52.7

⁽¹⁾ These percentages were calculated using data from the NEWCRONOS table *p_ga_uws*.⁽²⁾ 1998.⁽³⁾ Greece 1998.

(1) Table 5

Population, aged 15 years or more, by degree of urbanisation of residence and labour status

Percentages of the Male and/or Female population living in a given type of area

IRL	I	L	NL	A	P	FIN	S	UK	
Males and Females									
56.7	41.9	52.1	60.3	56.3	57.5	61.8	65.7	57.0	Densely Populated area
3.3	6.2	1.9	2.2	3.6	3.7	6.0	4.4	4.3	Employed
39.9	51.8	46.1	37.4	40.1	38.8	32.2	29.9	38.7	Unemployed
									Inactive
	43.6	49.8	60.3	56.1	61.5	56.4	65.7	60.8	Intermediate Populated area
	4.9	1.0	2.3	2.2	2.0	8.5	4.4	3.0	Employed
	51.5	49.2	37.4	41.6	36.5	35.1	29.9	36.1	Unemployed
									Inactive
53.4	41.1	52.9	57.3	56.1	55.7	52.6	63.2	56.7	Thinly Populated area
3.3	5.6	(1.0)	2.5	2.4	2.5	7.8	5.7	3.3	Employed
43.4	53.2	46.1	40.2	41.5	41.7	39.6	31.1	39.9	Unemployed
									Inactive
Males									
66.3	55.4	63.1	69.6	65.2	65.5	65.9	67.2	64.3	Densely Populated area
4.4	6.5	(1.9)	2.1	4.4	4.3	6.7	5.2	5.6	Employed
29.2	38.1	35.0	28.3	30.4	30.2	27.4	27.6	30.1	Unemployed
									Inactive
	57.8	62.5	71.6	66.7	71.1	61.8	68.1	68.9	Intermediate Populated area
	4.4	(0.9)	1.7	2.2	1.8	8.7	5.2	3.7	Employed
	37.7	36.6	26.8	31.1	27.1	29.5	26.8	27.4	Unemployed
									Inactive
66.0	55.3	64.8	67.4	66.6	66.2	58.2	66.3	64.1	Thinly Populated area
3.9	5.2		(1.9)	2.8	2.3	7.7	6.4	4.2	Employed
30.0	39.5	34.6	30.7	30.5	31.5	34.1	27.3	31.7	Unemployed
									Inactive
Females									
48.2	29.7	41.1	51.4	48.6	50.3	58.3	64.3	50.0	Densely Populated area
2.3	6.0	(1.8)	2.4	2.8	3.2	5.4	3.6	3.1	Employed
49.5	64.3	57.1	46.2	48.6	46.4	36.3	32.1	46.9	Unemployed
									Inactive
	30.3	37.9	49.2	46.5	52.9	51.6	63.4	53.1	Intermediate Populated area
	5.4	(1.1)	2.9	2.3	2.2	8.2	3.7	2.4	Employed
	64.3	61.0	47.9	51.2	44.9	40.2	32.9	44.6	Unemployed
									Inactive
40.5	27.8	40.7	47.1	46.2	46.1	47.2	60.0	49.7	Thinly Populated area
2.6	6.0		(3.1)	2.0	2.8	7.9	5.0	2.5	Employed
56.9	66.1	57.9	49.8	51.8	51.1	44.9	35.0	47.9	Unemployed
									Inactive

 (1) These percentages were calculated using data from the NEWCRONOS table *p_ga_uws*

(2) 1998.

(3) Greece 1998.

Table 6⁽¹⁾

Population, aged 15 to 59 years, in education

Percentages of the Male and/or Female population in a given age group

	EU-15 ⁽⁴⁾	EUR-11 ⁽⁵⁾	B	DK	D	EL ⁽²⁾	E	F
	Males and Females							
15 years	97.0	96.4	94.5	98.8	100.0	93.0	100.0	99.7
16 years	92.5	92.5	95.5	95.5	100.0	91.2	83.6	97.1
17 years	87.8	89.1	94.5	84.6	99.9	84.9	77.7	95.1
18 years	79.1	81.4	88.8	85.3	90.5	70.2	71.1	86.7
19 years	67.7	69.9	74.6	72.5	76.5	60.3	66.0	75.4
20 years	55.8	57.1	61.9	67.6	57.9	49.0	58.2	65.6
21 years	48.1	48.3	61.2	50.1	49.3	35.0	50.5	51.8
22 years	40.4	40.6	43.7	57.6	41.3	27.6	46.1	42.6
23 years	35.1	35.0	38.7	57.4	35.8	22.7	41.0	31.4
24 years	29.6	29.3	24.2	47.1	32.6	13.7	33.6	22.1
15-24 years	63.0	63.5	68.2	69.9	69.8	55.1	61.4	67.3
25-34 years	14.1	11.7	11.0	30.2	13.0	3.0	12.2	6.1
35-59 years	6.5	3.6	6.1	17.3	3.4	0.3	2.3	1.4
	Males							
15 years	97.1	96.6	92.4	98.1	100.0	92.0	100.0	99.6
16 years	91.4	91.5	94.1	95.5	100.0	89.4	81.9	96.7
17 years	86.5	88.0	94.0	82.0	99.7	82.3	74.4	94.8
18 years	77.6	80.0	88.0	79.4	91.6	67.8	66.9	84.1
19 years	66.4	67.9	69.8	70.8	75.0	65.0	61.6	72.0
20 years	52.6	53.1	55.9	68.8	53.7	46.3	51.7	61.6
21 years	45.3	44.9	57.0	48.4	46.4	32.3	43.1	49.9
22 years	39.3	39.6	42.2	44.8	42.0	26.3	41.7	41.9
23 years	33.8	33.3	37.6	55.0	37.3	24.2	35.5	30.3
24 years	29.9	29.5	22.9	48.6	36.3	15.6	29.7	22.1
15-24 years	61.9	62.3	66.2	68.5	70.2	55.2	56.9	66.5
25-34 years	14.3	12.3	11.8	26.5	14.8	3.0	11.2	5.9
35-59 years	5.9	3.7	7.1	14.2	3.4	0.3	1.8	1.2
	Females							
15 years	96.8	96.1	96.6	100.0	100.0	94.2	100.0	99.9
16 years	93.5	93.5	96.9	95.4	100.0	93.3	85.2	97.5
17 years	89.1	90.3	95.1	86.8	100.0	87.7	81.1	95.4
18 years	80.6	82.8	89.6	93.2	89.3	72.5	75.3	89.5
19 years	69.0	71.9	78.9	74.1	77.9	56.8	70.2	78.9
20 years	58.8	60.9	68.0	66.6	61.4	51.2	64.9	69.6
21 years	50.8	51.5	65.7	51.7	52.1	37.5	57.8	53.6
22 years	41.5	41.6	45.1	65.0	40.7	28.9	50.4	43.2
23 years	36.5	36.7	39.8	59.9	34.3	21.2	46.6	32.4
24 years	29.4	29.1	25.4	45.5	28.8	12.0	37.9	22.0
15-24 years	64.1	64.8	70.3	71.2	69.4	55.0	65.8	68.2
25-34 years	13.9	11.1	10.2	33.8	11.2	2.9	13.1	6.3
35-59 years	7.1	3.6	5.1	20.5	3.4	0.4	2.7	1.5

⁽¹⁾ These percentages were calculated using data from the NEWCRONOS table *p_ga_jed*. Non responses to the variable EDUCATION AND TRAINING RECEIVED DURING PREVIOUS WEEKS not considered.

⁽²⁾ 1998.

⁽³⁾ 1997.

⁽⁴⁾ Greece 1998, Ireland 1997, Austria 1997.

⁽⁵⁾ Ireland 1997, Austria 1997.

(1) Table 6

Population, aged 15 to 59 years, in education

Percentages of the Male and/or Female population in a given age group

IRL ⁽³⁾	I	L	NL	A ⁽³⁾	P	FIN	S	UK	
Males and Females									
97.7	85.6	96.8	95.1	95.9	92.2	96.8	100.0	100.0	15 years
95.3	84.4	93.1	94.7	93.2	81.8	94.6	99.6	91.2	16 years
87.1	79.3	92.1	89.5	90.7	73.9	86.8	98.4	80.2	17 years
72.8	76.9	89.4	79.3	74.6	61.8	78.1	97.6	65.9	18 years
58.6	62.0	75.3	75.8	54.8	58.6	57.8	67.2	56.9	19 years
51.3	48.9	75.1	65.8	40.0	48.5	46.5	50.4	49.9	20 years
40.8	40.0	55.8	58.5	30.9	43.3	53.7	59.2	48.3	21 years
30.0	34.2	39.8	50.5	33.5	29.3	51.3	47.9	38.9	22 years
22.8	31.4	35.9	42.9	29.4	30.4	47.6	50.2	34.0	23 years
17.4	29.7	30.7	37.3	27.6	22.4	44.0	46.9	30.2	24 years
59.7	55.1	66.7	68.3	56.3	52.2	66.6	71.3	60.3	15-24 years
9.0	11.7	8.3	22.5	14.0	8.0	25.0	33.0	23.4	25-34 years
3.9	3.4	4.4	10.8	5.6	1.4	17.1	24.6	18.3	35-59 years
Males									
97.4	87.5	96.7	95.0	96.2	92.9	95.7	100.0	100.0	15 years
94.5	82.4	94.1	92.9	94.4	78.3	93.7	99.3	89.9	16 years
83.6	77.2	95.6	89.6	92.4	72.4	85.0	99.5	78.2	17 years
68.5	74.6	88.3	80.2	77.9	59.2	79.8	97.2	64.5	18 years
56.8	63.1	74.5	75.5	53.5	55.7	50.4	66.6	58.5	19 years
49.4	47.1	74.8	64.2	39.8	42.0	36.9	39.6	52.1	20 years
38.5	35.7	59.3	58.8	34.8	40.1	46.4	59.1	47.8	21 years
28.5	32.1	(41.2)	55.3	35.6	27.0	51.5	45.4	38.9	22 years
21.2	28.8	(41.5)	43.3	31.7	24.5	43.7	43.9	34.7	23 years
16.9	28.3	(37.8)	41.1	29.1	23.2	45.4	47.4	30.2	24 years
57.8	53.7	68.7	69.4	58.4	49.6	63.9	69.2	60.0	15-24 years
9.4	11.9	9.2	24.7	16.2	7.5	24.7	31.3	22.1	25-34 years
3.7	3.7	5.2	11.1	6.3	1.3	14.8	21.1	15.1	35-59 years
Females									
98.0	83.6	96.9	95.3	95.5	91.4	97.8	100.0	100.0	15 years
96.1	86.5	91.9	96.5	91.9	85.2	95.7	100.0	92.7	16 years
90.7	81.4	88.7	89.4	88.7	75.7	88.5	97.2	82.4	17 years
77.3	79.3	90.3	78.3	71.7	64.6	76.2	98.0	67.4	18 years
60.6	61.0	76.2	76.1	56.0	61.2	63.0	67.9	55.3	19 years
53.2	50.6	75.4	67.4	40.2	54.7	53.5	63.3	47.6	20 years
43.2	43.5	(51.6)	58.1	27.7	46.7	60.9	59.3	48.7	21 years
31.8	36.2	(38.2)	45.3	31.5	31.4	51.1	50.6	38.9	22 years
24.5	34.2	(30.0)	42.4	27.5	36.6	52.0	56.2	33.3	23 years
17.9	31.2	(23.3)	33.8	25.9	21.6	42.3	46.5	30.3	24 years
61.6	56.5	64.6	67.3	54.3	54.7	69.2	73.5	60.6	15-24 years
8.7	11.5	7.4	20.1	11.8	8.6	25.4	34.8	24.8	25-34 years
4.1	3.1	3.5	10.5	4.8	1.5	19.4	28.1	21.4	35-59 years

(1) These percentages were calculated using data from the NEWCRONOS table *p_ga_ied*. Non responses to the variable EDUCATION AND TRAINING RECEIVED DURING PREVIOUS WEEKS not considered.

(2) 1998.

(3) 1997.

(4) Greece 1998, Ireland 1997, Austria 1997.

(5) Ireland 1997, Austria 1997.

Table 7⁽¹⁾

Population, aged 25 to 59 years, by age groups and educational attainment level

Percentages of the Male and/or Female population aged 25-59 years, Percentages of the Male and/or Female population in a given age group⁽²⁾

	EU-15 ⁽⁵⁾	EUR-11 ⁽⁶⁾	B	DK	D	EL ⁽³⁾	E	F
Males and Females								
25-34 years*	30.7	30.6	30.2	30.2	28.9	30.6	31.1	30.7
Less than upper secondary (L)	26.8	30.5	25.8	12.8	16.0	30.9	45.5	24.4
Upper secondary level (M)	49.3	47.0	39.8	58.6	62.5	44.8	21.8	45.8
Third level (H)	23.9	22.5	34.4	28.6	21.5	24.3	32.7	29.8
35-49 years*	44.3	44.5	46.2	42.6	45.1	43.3	43.9	46.1
Less than upper secondary (L)	35.2	38.6	40.7	20.3	17.2	48.3	63.3	37.9
Upper secondary level (M)	43.1	41.3	31.5	51.3	57.2	33.2	16.4	42.0
Third level (H)	21.7	20.2	27.8	28.4	25.7	18.5	20.3	20.1
50-59 years*	25.0	24.8	23.6	27.2	26.0	26.1	25.0	23.2
Less than upper secondary (L)	48.0	51.1	56.1	23.3	23.6	69.7	81.4	50.1
Upper secondary level (M)	35.0	33.3	23.3	52.0	53.8	19.6	7.2	34.4
Third level (H)	17.0	15.6	20.7	24.7	22.6	10.7	11.4	15.4
25-59 years*	100.0	100.0	100.0	100.0	100.0	100.0	100.0	100.0
Less than upper secondary (L)	35.8	39.1	39.8	18.9	18.4	48.6	62.3	36.6
Upper secondary level (M)	43.0	41.1	32.1	53.7	57.9	33.2	15.8	41.4
Third level (H)	21.2	19.8	28.1	27.5	23.7	18.2	22.0	22.0
Males								
25-34 years*	30.9	30.8	30.4	29.7	29.0	30.6	31.7	30.8
Less than upper secondary (L)	27.4	31.3	30.0	12.3	14.6	32.7	48.7	24.6
Upper secondary level (M)	49.3	47.1	39.5	59.4	62.2	45.3	21.4	47.7
Third level (H)	23.3	21.6	30.5	28.3	23.2	22.0	29.9	27.7
35-49 years*	44.3	44.5	46.3	43.4	45.1	43.7	43.5	46.0
Less than upper secondary (L)	32.6	36.0	41.7	18.9	13.7	46.3	61.3	34.7
Upper secondary level (M)	44.1	42.1	30.9	56.0	56.0	31.9	16.8	45.5
Third level (H)	23.3	21.9	27.4	25.2	30.2	21.8	21.9	19.8
50-59 years*	24.8	24.6	23.3	26.9	25.9	25.7	24.8	23.2
Less than upper secondary (L)	42.1	45.3	52.6	16.5	16.2	64.6	76.4	44.6
Upper secondary level (M)	37.3	35.2	24.2	55.8	53.1	20.3	8.4	38.9
Third level (H)	20.6	19.5	23.2	27.8	30.8	15.0	15.3	16.5
25-59 years*	100.0	100.0	100.0	100.0	100.0	100.0	100.0	100.0
Less than upper secondary (L)	33.3	36.8	40.7	16.3	14.6	46.9	61.0	33.9
Upper secondary level (M)	44.1	42.0	32.0	57.0	57.1	33.0	16.2	44.7
Third level (H)	22.6	21.2	27.3	26.8	28.3	20.1	22.8	21.4
Females								
25-34 years*	30.5	30.4	30.1	30.7	28.8	30.6	30.4	30.6
Less than upper secondary (L)	26.3	29.6	21.4	13.3	17.4	29.2	42.2	24.2
Upper secondary level (M)	49.3	47.0	40.1	57.7	62.9	44.3	22.1	44.0
Third level (H)	24.5	23.4	38.5	29.0	19.7	26.5	35.6	31.9
35-49 years*	44.3	44.6	46.1	41.8	45.1	42.8	44.3	46.1
Less than upper secondary (L)	37.9	41.1	39.7	21.9	20.8	50.3	65.2	41.0
Upper secondary level (M)	42.0	40.4	32.0	46.2	58.3	34.4	16.0	38.6
Third level (H)	20.1	18.5	28.2	31.9	20.9	15.3	18.8	20.4
50-59 years*	25.2	25.0	23.9	27.5	26.1	26.5	25.3	23.3
Less than upper secondary (L)	53.9	56.9	59.5	30.2	31.1	74.4	86.1	55.6
Upper secondary level (M)	32.7	31.4	22.3	48.1	54.6	19.0	6.1	30.0
Third level (H)	13.4	11.7	18.1	21.6	14.2	6.7	7.8	14.4
25-59 years*	100.0	100.0	100.0	100.0	100.0	100.0	100.0	100.0
Less than upper secondary (L)	38.2	41.4	39.0	21.5	22.4	50.2	63.5	39.3
Upper secondary level (M)	42.0	40.2	32.1	50.3	58.7	33.4	15.4	38.2
Third level (H)	19.8	18.4	28.9	28.2	18.9	16.5	21.1	22.5

⁽¹⁾ These percentages were calculated using data from the NEWCRONOS table *p_ga_ed*.⁽²⁾ Non responses to the variable HIGHER LEVEL OF EDUCATION ATTAINED not considered.⁽³⁾ 1998.⁽⁴⁾ 1997.⁽⁵⁾ Greece 1998, Ireland 1997.⁽⁶⁾ Ireland 1997.

(1) Table 7

Population, aged 25 to 59 years, by age groups and educational attainment level

 *Percentages of the Male and/or Female population aged 25-59 years, Percentages of the Male and/or Female population in a given age group⁽²⁾

IRL	I	L	NL	A	P	FIN	S	UK	
Males and Females									
33.0	32.3	33.3	31.2	32.0	32.9	26.4	29.5	31.3	25-34 years*
34.3	44.0	31.7	25.6	15.9	69.5	14.4	12.6	10.7	Less than upper secondary (L)
34.4	46.1	47.1	49.3	74.4	18.3	48.1	55.5	60.1	Upper secondary level (M)
31.2	10.0	21.2	25.1	9.6	12.2	37.4	31.8	29.1	Third level (H)
45.3	42.5	45.6	44.7	43.3	43.3	46.4	42.3	43.7	35-49 years*
50.9	52.5	35.2	33.6	23.1	80.2	21.6	20.5	18.1	Less than upper secondary (L)
27.6	36.3	46.1	42.1	67.3	10.2	44.9	48.8	53.2	Upper secondary level (M)
21.4	11.2	18.7	24.2	9.6	9.6	33.5	30.7	28.7	Third level (H)
21.8	25.2	21.1	24.1	24.7	23.9	27.2	28.3	25.0	50-59 years*
66.0	70.8	44.5	44.9	32.7	87.2	42.9	31.2	32.8	Less than upper secondary (L)
19.5	21.2	38.0	36.2	60.7	5.5	30.4	43.3	44.0	Upper secondary level (M)
14.4	8.0	17.5	18.9	6.6	7.3	26.7	25.5	23.3	Third level (H)
100.0	100.0	100.0	100.0	100.0	100.0	100.0	100.0	100.0	25-59 years*
48.7	54.2	36.0	33.8	23.2	78.0	25.5	21.2	19.3	Less than upper secondary (L)
28.1	35.8	44.8	42.9	67.9	12.0	41.8	49.3	53.2	Upper secondary level (M)
23.2	10.0	19.3	23.2	8.9	10.0	32.7	29.6	27.5	Third level (H)
Males									
32.7	32.6	33.6	31.3	32.0	33.7	26.5	29.6	31.7	25-34 years*
39.0	46.6	31.2	26.7	11.8	72.8	16.2	13.3	9.6	Less than upper secondary (L)
30.7	44.4	46.6	48.4	78.9	17.7	53.5	57.4	59.6	Upper secondary level (M)
30.3	9.0	22.2	24.9	9.3	9.5	30.3	29.3	30.8	Third level (H)
45.2	42.6	45.6	44.6	43.8	43.2	46.8	42.3	43.6	35-49 years*
54.3	51.8	30.6	30.5	16.2	81.0	23.7	22.7	13.7	Less than upper secondary (L)
23.4	36.5	47.2	42.1	73.8	10.3	47.2	47.9	55.8	Upper secondary level (M)
22.4	11.7	22.3	27.4	10.1	8.6	29.1	29.3	30.4	Third level (H)
22.2	24.8	20.8	24.1	24.2	23.1	26.7	28.1	24.7	50-59 years*
68.9	67.1	33.9	34.7	22.7	86.7	43.4	33.3	24.7	Less than upper secondary (L)
16.0	23.7	43.0	41.5	68.4	6.6	29.2	42.4	48.9	Upper secondary level (M)
15.1	9.2	23.2	23.8	9.0	6.7	27.4	24.3	26.3	Third level (H)
100.0	100.0	100.0	100.0	100.0	100.0	100.0	100.0	100.0	25-59 years*
52.5	53.9	31.5	30.3	16.3	79.5	27.0	22.9	15.0	Less than upper secondary (L)
24.1	35.9	46.1	43.9	74.1	12.0	44.1	49.2	55.4	Upper secondary level (M)
23.4	10.2	22.4	25.8	9.6	8.5	29.0	27.9	29.6	Third level (H)
Females									
33.2	32.0	33.0	31.2	32.0	32.1	26.3	29.4	30.9	25-34 years*
29.8	41.3	32.1	24.5	20.1	66.3	12.6	11.9	11.8	Less than upper secondary (L)
38.1	47.8	47.7	50.1	69.9	18.8	42.6	53.6	60.7	Upper secondary level (M)
32.1	11.0	20.2	25.3	10.0	14.9	44.8	34.5	27.5	Third level (H)
45.4	42.4	45.5	44.7	42.9	43.3	46.0	42.2	43.8	35-49 years*
47.6	53.2	40.0	36.8	30.2	79.5	19.2	18.1	22.3	Less than upper secondary (L)
31.9	36.0	45.1	42.2	60.7	10.0	42.6	49.8	50.7	Upper secondary level (M)
20.5	10.8	15.0	21.1	9.1	10.5	38.2	32.1	27.0	Third level (H)
21.3	25.6	21.5	24.1	25.1	24.6	27.8	28.4	25.3	50-59 years*
63.0	74.5	54.9	55.4	42.5	87.7	42.5	29.0	40.7	Less than upper secondary (L)
23.2	18.8	33.1	30.7	53.3	4.3	31.5	44.3	39.1	Upper secondary level (M)
13.8	6.7	12.0	13.9	4.3	8.0	26.0	26.7	20.2	Third level (H)
100.0	100.0	100.0	100.0	100.0	100.0	100.0	100.0	100.0	25-59 years*
45.0	54.6	40.6	37.5	30.1	76.5	23.9	19.4	23.4	Less than upper secondary (L)
32.1	35.6	43.4	41.9	61.8	11.9	39.5	49.4	51.0	Upper secondary level (M)
22.9	9.8	16.1	20.7	8.2	11.5	36.6	31.2	25.5	Third level (H)

 (1) These percentages were calculated using data from the NEWCRONOS table *p_ga_ed*.

(2) Non responses to the variable HIGHER LEVEL OF EDUCATION ATTAINED not considered.

(3) 1998.

(4) 1997.

(5) Greece 1998, Ireland 1997.

(6) Ireland 1997.

Table 8

Active population by age groups and nationality

Thousands

	EU-15 ⁽²⁾	EUR-11	B	DK	D	EL ⁽¹⁾	E	F
Males and Females								
15-24 years	21 687	15 925	410	445	4 454	567	2 492	2 614
Nationals	20 670	15 082	381	434	3 937	536	2 468	2 489
Non-Nationals/EU-Nationals	265	206	16	.	115	.	7	31
Non-National/NonEU-Nationals	751	636	13	10	402	31	17	93
25-49 years	113 272	88 174	3 231	1 725	25 931	2 831	10 599	18 486
Nationals	107 482	83 481	2 932	1 679	23 628	2 708	10 445	17 365
Non-Nationals/EU-Nationals	2 013	1 632	209	18	705	6	42	411
Non-National/NonEU-Nationals	3 776	3 061	90	28	1 598	117	111	709
50-64 years	34 479	25 423	691	669	8 860	933	3 132	4 688
Nationals	33 070	24 257	640	654	8 234	921	3 106	4 345
Non-Nationals/EU-Nationals	658	510	43	7	245	.	15	150
Non-National/NonEU-Nationals	752	656	8	8	381	11	10	192
65 & + years	1 991	1 331	32	16	351	114	116	95
Nationals	1 946	1 306	31	15	337	113	115	91
Non-Nationals/EU-Nationals
Non-National/NonEU-Nationals	8	.	.	.
15-64 years	169 439	129 522	4 332	2 839	39 244	4 331	16 223	25 787
Nationals	161 222	122 820	3 953	2 767	35 799	4 165	16 020	24 200
Non-Nationals/EU-Nationals	2 936	2 347	268	25	1 066	8	64	592
Non-National/NonEU-Nationals	5 279	4 354	111	47	2 380	158	139	995
Males								
15-24 years	11 686	8 591	225	227	2 363	304	1 381	1 420
Nationals	11 131	8 118	207	221	2 071	283	1 369	1 346
Non-Nationals/EU-Nationals	139	115	11	.	63	.	(3)	19
Non-National/NonEU-Nationals	416	358	8	6	228	20	9	55
25-49 years	63 716	49 843	1 793	920	14 441	1 675	6 219	9 988
Nationals	60 173	46 910	1 598	897	12 957	1 604	6 135	9 311
Non-Nationals/EU-Nationals	1 174	981	132	8	436	.	24	241
Non-National/NonEU-Nationals	2 368	1 952	64	15	1 048	69	61	437
50-64 years	20 884	15 685	450	372	5 253	633	2 182	2 577
Nationals	19 934	14 862	411	365	4 818	625	2 165	2 330
Non-Nationals/EU-Nationals	412	341	32	(3)	169	.	11	89
Non-National/NonEU-Nationals	538	482	7	(4)	266	8	6	158
65 & + years	1 295	863	23	10	222	80	75	62
Nationals	1 262	844	22	9	212	80	74	59
Non-Nationals/EU-Nationals
Non-National/NonEU-Nationals
15-64 years	96 286	74 119	2 468	1 519	22 057	2 613	9 782	13 986
Nationals	91 238	69 890	2 216	1 483	19 846	2 512	9 669	12 987
Non-Nationals/EU-Nationals	1 726	1 436	174	11	668	(4)	38	348
Non-National/NonEU-Nationals	3 321	2 792	78	25	1 542	97	76	651
Females								
15-24 years	10 001	7 333	185	219	2 091	264	1 111	1 194
Nationals	9 539	6 964	174	213	1 866	252	1 099	1 143
Non-Nationals/EU-Nationals	126	91	5	.	52	.	(4)	13
Non-National/NonEU-Nationals	336	279	6	5	173	11	8	38
25-49 years	49 556	38 331	1 438	805	11 490	1 155	4 379	8 497
Nationals	47 309	36 571	1 334	782	10 671	1 104	4 311	8 055
Non-Nationals/EU-Nationals	839	651	78	10	269	(4)	19	170
Non-National/NonEU-Nationals	1 408	1 110	26	13	550	48	50	272
50-64 years	13 595	9 738	241	297	3 607	300	950	2 110
Nationals	13 136	9 395	229	289	3 416	296	941	2 015
Non-Nationals/EU-Nationals	246	169	11	(4)	77	.	(4)	61
Non-National/NonEU-Nationals	214	174	.	(4)	115	(3)	(4)	34
65 & + years	696	468	9	6	129	34	41	33
Nationals	684	461	9	6	126	34	41	32
Non-Nationals/EU-Nationals
Non-National/NonEU-Nationals
15-64 years	73 153	55 403	1 864	1 320	17 188	1 719	6 441	11 801
Nationals	69 984	52 930	1 737	1 284	15 952	1 653	6 351	11 213
Non-Nationals/EU-Nationals	1 211	911	94	14	398	(4)	27	244
Non-National/NonEU-Nationals	1 957	1 562	33	21	838	62	63	344

⁽¹⁾ 1998.⁽²⁾ Greece 1998.

Table 8

Active population by age groups and nationality

Thousands

IRL	I	L	NL	A	P	FIN	S	UK	
Males and Females									
334	2 650	16	1 267	534	751	402	432	4 318	15-24 years
326	2 628	8	1 229	477	740	400	421	4 197	Nationals
7	.	8	12	4	(3)	.	.	55	Non-Nationals/EU-Nationals
.	20	(1)	26	54	8	.	.	66	Non-National/NonEU-Nationals
1 037	16 199	137	5 209	2 654	3 050	1 641	2 651	17 891	25-49 years
996	16 018	79	5 016	2 383	3 002	1 616	2 519	17 096	Nationals
33	21	52	99	43	12	5	52	305	Non-Nationals/EU-Nationals
8	161	6	94	229	36	20	80	489	Non-National/NonEU-Nationals
284	4 162	27	1 362	636	998	584	1 247	6 207	50-64 years
276	4 142	18	1 325	599	992	581	1 212	6 025	Nationals
8	(5)	8	26	7	.	.	24	117	Non-Nationals/EU-Nationals
.	15	(1)	10	30	(4)	.	12	65	Non-National/NonEU-Nationals
34	335	(1)	53	34	265	15	57	473	65 & + years
34	334	.	53	33	264	15	55	457	Nationals
.	10	Non-Nationals/EU-Nationals
.	Non-National/NonEU-Nationals
1 655	23 012	180	7 837	3 825	4 798	2 627	4 331	28 416	15-64 years
1 598	22 788	105	7 570	3 459	4 735	2 596	4 151	27 318	Nationals
47	29	68	138	54	17	6	79	477	Non-Nationals/EU-Nationals
10	196	7	130	313	47	25	100	620	Non-National/NonEU-Nationals
Males									
182	1 469	9	640	284	411	207	225	2 339	15-24 years
179	1 457	4	622	254	404	205	219	2 289	Nationals
(3)	.	4	(6)	3	.	.	.	22	Non-Nationals/EU-Nationals
.	11	.	12	28	5	.	.	28	Non-National/NonEU-Nationals
603	9 815	82	2 931	1 462	1 639	868	1 391	9 886	25-49 years
578	9 696	49	2 816	1 303	1 615	853	1 327	9 435	Nationals
20	11	30	54	25	7	(4)	22	161	Non-Nationals/EU-Nationals
5	108	4	62	135	17	11	42	290	Non-National/NonEU-Nationals
194	2 875	18	883	398	566	289	651	3 542	50-64 years
189	2 861	12	854	372	563	287	632	3 450	Nationals
5	(4)	5	21	4	.	.	13	55	Non-Nationals/EU-Nationals
.	10	.	(9)	22	.	.	.	37	Non-National/NonEU-Nationals
27	232	(1)	40	19	150	11	47	296	65 & + years
27	232	.	40	19	149	11	44	284	Nationals
.	Non-Nationals/EU-Nationals
.	Non-National/NonEU-Nationals
980	14 159	109	4 455	2 144	2 615	1 364	2 268	15 767	15-64 years
946	14 013	65	4 292	1 928	2 583	1 345	2 179	15 173	Nationals
28	17	39	80	32	9	(4)	36	239	Non-Nationals/EU-Nationals
6	129	5	83	184	24	14	53	355	Non-National/NonEU-Nationals
Females									
152	1 181	8	627	250	340	196	207	1 978	15-24 years
147	1 171	3	607	223	336	195	201	1 908	Nationals
(4)	.	4	(6)	32	Non-Nationals/EU-Nationals
.	9	.	14	26	(3)	.	.	38	Non-National/NonEU-Nationals
434	6 385	54	2 278	1 192	1 411	773	1 260	8 005	25-49 years
418	6 322	30	2 200	1 080	1 387	762	1 191	7 661	Nationals
13	10	22	46	18	5	.	30	145	Non-Nationals/EU-Nationals
(3)	53	2	32	94	19	9	39	199	Non-National/NonEU-Nationals
90	1 287	9	478	238	432	295	596	2 665	50-64 years
87	1 281	6	471	227	429	294	580	2 576	Nationals
(3)	.	3	(5)	3	.	.	11	61	Non-Nationals/EU-Nationals
.	(5)	.	.	9	.	.	.	28	Non-National/NonEU-Nationals
7	103	.	13	15	115	(4)	11	177	65 & + years
7	102	.	13	14	115	(4)	11	172	Nationals
.	Non-Nationals/EU-Nationals
.	Non-National/NonEU-Nationals
675	8 853	71	3 383	1 681	2 183	1 263	2 062	12 649	15-64 years
652	8 775	39	3 278	1 530	2 152	1 251	1 972	12 145	Nationals
20	12	29	57	22	8	.	43	238	Non-Nationals/EU-Nationals
(4)	66	3	47	129	23	11	47	265	Non-National/NonEU-Nationals

(1) 1998.

(2) Greece 1998.

Table 9⁽¹⁾

Composition of private households

*Percentages of total number of households, Percentages of the total number of households of a given type

	EU-15 ⁽²⁾ (5)	EUR-11 ⁽²⁾ (6)	B	DK ⁽²⁾	D	EL ⁽³⁾	E	F
	Percentage of households							
1 person household*	28.4	28.4	29.5	—	34.9	21.2	14.3	30.6
1 male aged 15-64 years	30.2	30.3	29.0	—	34.2	23.4	17.4	31.1
1 female aged 15-64 years	9.3	8.7	10.2	—	6.6	10.7	13.4	9.0
1 male aged 65 or+years	25.6	25.7	24.1	—	27.7	26.4	16.9	27.7
1 female aged 65 or+years	34.9	35.3	36.7	—	31.5	39.5	52.3	32.2
Several adults and no children*	45.6	46.1	44.7	—	43.5	53.2	56.3	42.3
2 adults both aged 15-64 years	37.8	36.2	36.4	—	46.8	26.3	17.7	43.5
At least 1 aged 65 or+years	35.3	36.0	35.2	—	31.5	41.8	46.8	34.0
3 or more adults	35.2	36.8	34.8	—	26.2	45.5	55.0	27.4
1 adult & children*	2.6	2.0	2.4	—	2.3	0.9	0.8	2.6
1 male adult & children	10.1	10.8	14.5	—	10.2	13.7	7.0	10.9
1 female adult & children	89.9	89.2	85.5	—	89.8	86.3	93.0	89.1
2 adults & children*	17.0	16.8	17.4	—	14.7	16.7	17.0	18.1
2 adults & 1 child	43.3	44.6	38.9	—	46.4	41.2	44.9	41.8
2 adults & 2 children	43.5	43.1	44.2	—	41.9	48.2	47.7	41.8
2 adults & 3 children	10.6	10.1	13.1	—	9.6	8.8	6.5	13.3
2 adults & 4 or more children	2.5	2.2	3.9	—	2.2	1.8	0.9	3.1
3 or more adults & children*	6.5	6.7	6.0	—	4.6	8.1	11.5	6.3

⁽¹⁾ These percentages were calculated using data from the NEWCRONOS table *p_house*.⁽²⁾ Data concerning household composition not available for Denmark, Finland and Sweden. EU-15 and EUR-11 calculated without these 3 countries.⁽³⁾ 1998.⁽⁴⁾ 1997.⁽⁵⁾ Greece 1998, Ireland 1997.⁽⁶⁾ Ireland 1997.

(1) Table 9

Composition of private households

Percentages of total number of households. Percentages of the total number of households of a given type

IRL ⁽⁴⁾	I	L	NL	A	P	FIN ⁽²⁾	S ⁽²⁾	UK	
Percentage of households									
22.6	23.8	25.0	32.4	30.3	14.2	-	-	29.6	1 person household*
31.1	22.5	32.0	36.3	31.2	15.9	-	-	30.8	1 male aged 15-64 years
14.7	11.7	9.4	7.5	6.7	12.6	-	-	11.9	1 female aged 15-64 years
23.5	19.6	28.7	29.6	28.5	21.0	-	-	24.9	1 male aged 65 or+years
30.7	46.2	29.9	26.6	33.7	50.5	-	-	32.4	1 female aged 65 or+years
40.9	50.1	43.3	43.5	43.1	50.5	-	-	41.9	Several adults and no children*
33.6	22.7	36.9	54.7	39.6	21.9	-	-	48.1	2 adults both aged 15-64 years
32.4	40.3	34.2	24.7	34.2	40.6	-	-	30.6	At least 1 aged 65 or+years
44.5	51.1	39.6	22.1	35.2	52.1	-	-	25.3	3 or more adults
2.8	1.2	2.1	1.9	2.5	1.5	-	-	5.5	1 adult & children*
.	16.9	.	9.9	4.9	(5.0)	-	-	8.8	1 male adult & children
92.9	83.1	89.9	90.1	95.1	95.0	-	-	91.2	1 female adult & children
20.4	17.4	21.9	17.7	16.6	21.0	-	-	17.9	2 adults & children*
29.3	48.9	39.3	32.7	43.5	57.5	-	-	38.3	2 adults & 1 child
39.9	43.4	43.7	48.5	44.1	35.7	-	-	44.4	2 adults & 2 children
20.9	7.0	14.0	14.8	10.4	5.8	-	-	13.2	2 adults & 3 children
10.0	0.7	(3.0)	4.0	2.0	1.0	-	-	4.1	2 adults & 4 or more children
13.2	7.5	7.7	4.4	7.6	12.7	-	-	5.1	3 or more adults & children*

 (1) These percentages were calculated using data from the N EWCRONOS table *p_house*.

(2) Data concerning household composition not available for Denmark, Finland and Sweden. EU-15 and EUR-11 calculated without these 3 countries.

(3) 1998.

(4) 1997.

(5) Greece 1998, Ireland 1997.

(6) Ireland 1997.

Table 10⁽¹⁾

Population by household position

*Percentages of the total population. Percentages of the population in a given age group

	EU-15 ^{(2) (5)}	EUR-11 ^{(2) (6)}	B	DK ⁽²⁾	D	EL ⁽³⁾	E	F
Males and Females								
0-24 years*	29.5	29.0	29.9	—	26.3	29.1	30.7	31.8
Living at parental home	89.4	90.2	89.4	—	88.4	89.0	92.2	89.2
Living alone	2.3	2.5	1.6	—	4.4	2.7	0.1	3.5
Living w/ partner	2.2	2.2	1.3	—	2.8	1.3	0.5	3.6
Living w/ partner & children	1.3	1.3	0.8	—	1.6	1.3	0.5	1.4
Living w/ partner & others				—	0.0	(0.1)	(0.0)	(0.0)
Living w/out partner, w/children	0.3	0.2	0.3	—	0.3			0.2
Living w/out partner, w/parents	0.1	0.1	1.3	—	0.1		0.0	(0.0)
Living house of son/daughter				—				(0.0)
Other types	4.3	3.7	5.4	—	2.4	5.4	6.6	2.1
25-49 years*	36.7	36.9	37.0	—	37.3	34.7	34.7	36.9
Living at parental home	11.9	12.8	5.0	—	6.9	19.0	25.5	6.3
Living alone	10.0	10.0	10.1	—	15.6	5.1	2.3	11.4
Living w/ partner	14.3	13.7	10.9	—	17.6	9.7	7.8	15.2
Living w/ partner & children	54.4	55.0	56.0	—	52.0	56.5	54.6	58.9
Living w/ partner & others	1.3	1.3	1.1	—	1.1	4.2	2.9	0.7
Living w/out partner, w/children	4.8	4.1	5.8	—	4.7	2.3	2.4	5.4
Living w/out partner, w/parents	0.5	0.5	3.9	—	0.3	0.9	0.5	0.4
Living house of son/daughter	0.1	0.1	0.9	—	0.0		0.0	(0.0)
Other types	2.8	2.7	6.2	—	1.7	2.2	4.0	1.6
50-64 years*	17.7	17.8	16.5	—	20.0	18.9	16.8	15.9
Living at parental home	1.1	1.2	0.6	—	0.5	1.0	2.7	0.9
Living alone	12.1	11.7	13.8	—	14.9	7.2	4.6	14.1
Living w/ partner	41.1	39.6	42.3	—	54.2	32.6	18.0	48.6
Living w/ partner & children	36.2	37.8	25.5	—	24.4	47.5	58.1	28.7
Living w/ partner & others	2.2	2.3	1.6	—	1.6	3.9	6.2	1.5
Living w/out partner, w/children	4.3	4.3	2.9	—	2.7	4.2	6.0	3.8
Living w/out partner, w/parents	0.4	0.4	0.9	—	0.4	0.7	0.5	0.4
Living house of son/daughter	0.8	0.8	8.8	—	0.4	1.6	0.8	0.5
Other types	1.8	1.9	3.7	—	0.9	1.3	3.1	1.4
65 or + years*	16.1	16.2	16.6	—	16.4	17.3	17.8	15.4
Living at parental home	0.1	0.1		—			0.3	0.2
Living alone	32.1	31.4	34.6	—	37.5	23.0	17.3	34.4
Living w/ partner	46.4	45.8	48.3	—	50.2	45.4	39.2	51.8
Living w/ partner & children	9.1	9.7	2.2	—	4.7	15.1	19.4	5.2
Living w/ partner & others	0.4	0.4	0.3	—	0.3	0.7	1.1	0.5
Living w/out partner, w/children	4.3	4.4	1.2	—	2.2	3.8	8.1	2.5
Living w/out partner, w/parents		0.1		—	0.1		0.1	(0.1)
Living house of son/daughter	4.2	4.4	9.0	—	3.4	9.2	8.3	3.1
Other types	3.4	3.6	4.4	—	1.6	2.6	6.1	2.3

(1) These percentages were calculated using data from the NEWCRONOS table *p_hou_po*.

(2) Data concerning household composition not available for Denmark, Finland and Sweden. EU-15 and EUR-11 calculated without these 3 countries.

(3) 1998.

(4) 1997.

(5) Greece 1998, Ireland 1997.

(6) Ireland 1997.

(1) Table 10

Population by household position

*Percentages of the total population. Percentages of the population in a given age group

IRL ⁽⁴⁾	I	L	NL	A	P	FIN ⁽²⁾	S ⁽²⁾	UK	
Males and Females									
41.2	26.9	30.2	30.8	29.0	33.0	-	-	31.6	0-24 years [*]
86.7	94.2	90.2	88.2	90.4	85.5	-	-	86.1	Living at parental home
0.9	0.5	1.4	4.7	1.9	0.4	-	-	1.7	Living alone
0.9	0.6	2.6	4.8	2.0	1.3	-	-	2.6	Living w/ partner
0.8	1.1	1.5	0.9	1.8	2.4	-	-	1.8	Living w/ partner & children
.	.	.	.	0.1	.	-	-	.	Living w/ partner & others
0.5	.	.	(0.2)	0.2	(0.1)	-	-	1.1	Living w/out partner, w/children
0.5	(0.0)	(0.8)	.	.	.	-	-	.	Living w/out partner, w/parents
.	-	-	.	Living house of son/daughter
9.6	3.5	3.3	1.2	3.5	10.2	-	-	6.7	Other types
34.8	37.3	40.3	39.4	38.8	35.6	-	-	36.3	25-49 years [*]
12.3	23.1	10.4	3.5	11.0	18.7	-	-	6.4	Living at parental home
6.3	5.4	9.3	13.8	11.7	2.2	-	-	11.1	Living alone
11.1	9.4	13.6	23.2	13.7	5.9	-	-	18.4	Living w/ partner
55.8	54.6	55.8	54.1	51.4	63.9	-	-	51.0	Living w/ partner & children
1.3	1.1	2.8	0.2	3.7	1.1	-	-	0.8	Living w/ partner & others
4.2	2.7	3.8	3.6	4.6	3.7	-	-	8.5	Living w/out partner, w/children
1.0	0.3	1.1	.	0.6	0.2	-	-	0.2	Living w/out partner, w/parents
0.6	0.0	(0.7)	.	.	.	-	-	.	Living house of son/daughter
7.4	3.3	2.5	1.6	3.3	4.2	-	-	3.6	Other types
13.5	18.4	15.5	17.1	17.1	16.5	-	-	16.9	50-64 years [*]
1.2	1.7	(1.3)	(0.3)	0.9	1.5	-	-	1.0	Living at parental home
11.4	8.8	10.7	14.4	13.4	5.2	-	-	15.3	Living alone
22.2	21.1	33.5	54.5	40.6	28.2	-	-	50.0	Living w/ partner
50.5	56.2	40.3	26.0	32.7	53.3	-	-	26.2	Living w/ partner & children
1.3	2.3	2.6	.	3.4	1.4	-	-	1.2	Living w/ partner & others
5.5	6.4	4.5	3.0	4.5	6.9	-	-	3.9	Living w/out partner, w/children
.	0.4	.	.	0.5	0.4	-	-	0.3	Living w/out partner, w/parents
2.8	0.5	4.3	(0.2)	2.0	0.5	-	-	0.5	Living house of son/daughter
4.8	2.6	(2.2)	1.4	1.9	2.7	-	-	1.6	Other types
10.5	17.4	14.0	12.8	15.1	14.9	-	-	15.2	65 or + years [*]
.	0.2	-	-	0.1	Living at parental home
32.3	29.8	27.0	37.9	33.1	20.3	-	-	37.6	Living alone
31.9	38.2	39.9	55.9	41.9	44.5	-	-	49.3	Living w/ partner
12.6	15.7	10.9	2.6	7.9	14.8	-	-	4.5	Living w/ partner & children
.	0.4	.	.	0.4	.	-	-	0.2	Living w/ partner & others
7.7	7.1	4.4	2.0	4.3	7.5	-	-	3.4	Living w/out partner, w/children
.	0.1	-	-	.	Living w/out partner, w/parents
6.2	3.6	12.5	(0.4)	9.3	3.1	-	-	2.6	Living house of son/daughter
9.0	5.1	4.5	1.2	3.1	9.4	-	-	2.3	Other types

 (1) These percentages were calculated using data from the NEWCRONOS table *p_hou_po*.

(2) Data concerning household composition not available for Denmark, Finland and Sweden. EU-15 and EUR-11 calculated without these 3 countries.

(3) 1998.

(4) 1997.

(5) Greece 1998, Ireland 1997.

(6) Ireland 1997.

Table 11⁽¹⁾

Female population aged 20 to 49 years, by the number of children and by labour status

*Percentages of the Female population aged 20-49. Percentages of the Female population aged 20-49 with a given number of children

	EU-15 ^{(2) (5)}	EUR-11 ^{(2) (6)}	B	DK ⁽²⁾	D	EL ⁽³⁾	E	F
Females								
0 child*	28.4	28.0	27.1	—	35.5	21.8	14.9	30.2
Employed	78.3	77.5	79.0	—	81.4	58.2	69.6	73.1
Unemployed	6.7	7.4	7.8	—	6.0	9.8	12.9	10.7
Inactive	15.0	15.1	13.2	—	12.6	32.1	17.5	16.2
1 child aged 0-14*	27.8	28.5	24.9	—	26.1	26.9	34.8	26.7
Employed	63.4	62.7	71.2	—	67.8	52.7	46.2	71.0
Unemployed	7.9	8.6	7.3	—	7.4	8.5	12.6	11.6
Inactive	28.7	28.7	21.5	—	24.8	38.8	41.2	17.3
2 children aged 0-14*	21.1	20.6	21.9	—	18.0	22.2	24.1	20.9
Employed	56.4	54.8	71.8	—	56.3	49.8	40.9	62.3
Unemployed	7.4	8.2	7.7	—	6.0	7.8	13.0	10.8
Inactive	36.2	37.1	20.5	—	37.7	42.4	46.2	26.9
3 or + children aged 0-14*	6.5	5.9	8.5	—	5.1	5.2	3.8	8.2
Employed	42.1	40.4	53.6	—	38.4	43.4	33.5	39.7
Unemployed	7.1	8.1	7.5	—	5.8	7.4	11.3	11.8
Inactive	50.8	51.5	38.9	—	55.8	49.2	55.2	48.5
1 child aged 0-2*	14.3	14.0	14.5	—	12.0	12.4	14.1	16.1
Employed	52.2	52.0	68.5	—	49.7	47.6	42.2	53.1
Unemployed	6.6	7.3	8.2	—	3.1	9.3	11.2	11.6
Inactive	41.2	40.8	23.3	—	47.2	43.1	46.6	35.3
2 children youngest aged 0-2*	6.2	6.1	6.2	—	5.2	5.4	6.7	6.6
Employed	48.8	48.1	72.4	—	46.3	46.1	38.2	47.7
Unemployed	6.1	6.7	6.3	—	2.6	9.4	10.4	10.6
Inactive	45.1	45.2	21.3	—	51.2	44.4	51.4	41.7
3or+ children youngest aged 0-2*	2.6	2.4	3.6	—	2.1	1.9	1.6	3.4
Employed	33.6	32.5	43.9	—	30.5	42.5	32.6	27.6
Unemployed	5.4	6.2	9.6	—	3.2	—	7.4	9.5
Inactive	61.0	61.2	46.5	—	66.3	51.3	60.0	62.9
1 child aged 3-5*	14.9	14.6	16.3	—	12.1	13.7	15.3	15.8
Employed	53.2	52.7	69.3	—	51.7	49.5	42.3	57.0
Unemployed	8.1	9.0	8.3	—	6.8	8.3	13.8	12.5
Inactive	38.7	38.3	22.5	—	41.5	42.2	44.0	30.5
2 children youngest aged 3-5*	5.3	5.2	5.5	—	4.3	5.6	6.4	5.2
Employed	55.5	54.3	72.5	—	53.6	48.5	40.0	66.5
Unemployed	8.6	9.6	7.8	—	7.9	6.8	15.2	13.3
Inactive	35.9	36.1	19.7	—	38.6	44.6	44.8	20.2
3or+ children youngest aged 3-5*	2.0	1.8	2.5	—	1.5	1.8	1.2	2.6
Employed	43.1	41.4	63.1	—	39.2	42.3	30.8	43.5
Unemployed	9.2	10.4	(6.6)	—	8.2	(8.6)	14.8	15.2
Inactive	47.7	48.2	30.4	—	52.6	49.1	54.4	41.3
1 child aged 6-14*	16.6	17.4	14.5	—	16.5	16.3	22.9	15.4
Employed	64.7	63.5	67.2	—	72.3	53.8	45.0	73.2
Unemployed	7.7	8.4	6.0	—	8.3	7.8	12.1	10.2
Inactive	27.6	28.1	26.8	—	19.4	38.4	42.9	16.6
2 children aged 6-14*	9.5	9.2	10.2	—	8.6	11.2	10.9	9.1
Employed	62.0	59.5	71.1	—	63.8	52.3	43.0	70.6
Unemployed	7.5	8.4	8.6	—	7.2	7.5	13.2	9.6
Inactive	30.5	32.2	20.4	—	29.0	40.2	43.8	19.8
3or+ children aged 6-14*	1.8	1.6	2.4	—	1.5	1.5	1.1	2.1
Employed	53.2	50.8	57.9	—	48.7	45.7	37.8	54.5
Unemployed	7.1	8.2	—	—	7.1	—	13.0	11.4
Inactive	39.7	41.0	36.7	—	44.3	46.9	49.1	34.2

⁽¹⁾ These percentages were calculated using data from the NEWCRONOS table *p_g_ws_c*.⁽²⁾ Data concerning household composition not available for Denmark, Finland and Sweden. EU-15 and EUR-11 calculated without these 3 countries.⁽³⁾ 1998.⁽⁴⁾ 1997.⁽⁵⁾ Greece 1998, Ireland 1997.⁽⁶⁾ Ireland 1997.

(1) Table 11

Female population aged 20 to 49 years, by the number of children and by labour status

*Percentages of the Female population aged 20-49, Percentages of the Female population aged 20-49 with a given number of children

IRL ⁽⁴⁾	I	L	NL	A	P	FIN ⁽²⁾	S ⁽²⁾	UK	
Females									
25.4	19.0	27.7	39.3	29.6	11.6	-	-	31.2	0 child*
77.0	69.0	83.8	85.6	84.2	77.8	-	-	84.0	Employed
5.6	7.7	.	2.7	3.5	4.2	-	-	3.4	Unemployed
17.4	23.2	14.0	11.7	12.3	18.0	-	-	12.6	Inactive
23.1	33.6	25.4	19.8	27.6	40.4	-	-	24.6	1 child aged 0-14*
51.3	51.0	61.1	67.3	74.9	77.7	-	-	68.5	Employed
6.4	7.7	(2.9)	3.3	3.6	4.0	-	-	4.3	Unemployed
42.2	41.3	35.9	29.4	21.5	18.3	-	-	27.1	Inactive
24.2	21.8	24.7	21.2	20.5	19.4	-	-	23.3	2 children aged 0-14*
45.3	42.4	50.1	63.6	64.6	70.5	-	-	64.2	Employed
6.2	8.1	.	3.7	4.3	3.8	-	-	3.9	Unemployed
48.5	49.5	47.5	32.7	31.2	25.7	-	-	31.9	Inactive
18.0	3.7	8.2	7.8	5.9	4.2	-	-	9.4	3 or + children aged 0-14*
33.9	30.2	35.1	54.9	54.0	50.7	-	-	47.0	Employed
5.2	7.5	.	(2.8)	4.8	8.2	-	-	4.2	Unemployed
60.9	62.3	63.5	42.3	41.2	41.1	-	-	48.8	Inactive
18.1	14.6	18.0	13.7	13.2	14.4	-	-	15.7	1 child aged 0-2*
47.6	47.3	48.5	61.6	68.3	70.8	-	-	53.5	Employed
5.8	7.1	(3.6)	3.0	3.0	6.0	-	-	3.6	Unemployed
46.6	45.6	47.9	35.4	28.8	23.3	-	-	42.9	Inactive
7.3	6.5	8.2	6.4	6.1	5.9	-	-	6.8	2 children youngest aged 0-2*
47.0	42.5	42.8	59.8	66.5	65.5	-	-	51.9	Employed
.	7.4	.	(3.1)	3.4	5.3	-	-	3.2	Unemployed
47.4	50.0	54.4	37.1	30.0	29.2	-	-	44.9	Inactive
7.3	1.6	3.7	2.8	2.3	1.7	-	-	3.6	3or+ children youngest aged 0-2*
31.3	30.2	(25.5)	44.5	57.6	41.4	-	-	36.1	Employed
.	6.9	-	-	3.0	Unemployed
63.7	62.9	72.1	53.9	40.7	53.5	-	-	60.9	Inactive
19.4	15.9	18.7	14.1	14.8	16.7	-	-	16.9	1 child aged 3-5*
43.2	44.8	44.1	58.0	63.5	72.6	-	-	55.9	Employed
6.4	8.3	.	3.4	5.5	4.5	-	-	4.6	Unemployed
50.3	46.9	53.8	38.6	31.0	22.9	-	-	39.5	Inactive
5.3	6.0	6.9	5.1	5.4	5.9	-	-	5.9	2 children youngest aged 3-5*
47.2	41.1	46.4	62.5	57.2	75.6	-	-	61.5	Employed
.	8.2	.	(3.1)	6.6	(3.0)	-	-	4.6	Unemployed
45.7	50.7	50.8	34.4	36.3	21.5	-	-	33.8	Inactive
5.5	1.2	2.4	2.4	1.9	1.3	-	-	2.9	3or+ children youngest aged 3-5*
33.5	29.7	(37.3)	51.5	46.9	48.7	-	-	48.0	Employed
.	8.4	.	.	7.1	(15.9)	-	-	5.7	Unemployed
61.0	61.9	(61.7)	45.6	46.0	35.4	-	-	46.2	Inactive
13.5	20.1	13.8	10.7	16.5	25.0	-	-	13.4	1 child aged 6-14*
45.1	49.2	59.7	66.7	73.3	76.9	-	-	74.1	Employed
5.8	7.5	.	3.4	3.5	3.4	-	-	3.7	Unemployed
49.1	43.2	37.5	29.9	23.2	19.7	-	-	22.2	Inactive
11.6	9.3	9.5	9.7	9.0	7.6	-	-	10.6	2 children aged 6-14*
43.3	43.2	59.0	66.6	67.7	70.4	-	-	73.6	Employed
(6.2)	8.6	.	4.5	3.4	(3.3)	-	-	4.0	Unemployed
50.5	48.2	39.2	28.9	28.9	26.3	-	-	22.4	Inactive
5.3	0.9	2.1	2.6	1.6	1.2	-	-	2.8	3or+ children aged 6-14*
37.8	31.0	(50.1)	69.3	57.3	66.8	-	-	60.0	Employed
.	(7.4)	-	-	4.2	Unemployed
57.0	61.6	(49.9)	26.5	36.1	29.2	-	-	35.8	Inactive

 (1) These percentages were calculated using data from the NEWCRONOS table *p_g_ws_c*.

(3) 1998.

(4) 1997.

(5) Greece 1998, Ireland 1997.

(6) Ireland 1997.

Table 12

Main characteristics of population and households by region

REGION	TOTAL POPULATION (Thousands)	POPULATION AGED 0-14 (% all Pop.)	POPULATION AGED 15-64 (% all Pop.)	POPULATION AGED 65 & MORE (% all Pop.)	NATION. (% all Pop.)	EU-NATION. (% all Pop.)	NON-EU - NON-NATION. (% all Pop.)	LESS UPPER SECONDARY (% all Pop.)
BELGIQUE-BELGIE	10 214	17.7	65.7	16.6	91.3	5.3	3.5	51.4
Bruxelles-Cap-BrusselsHf.gewest	954	17.7	65.3	17.0	72.0	13.3	14.6	47.1
Antwerpen	1 641	17.3	66.0	16.7	92.2	2.9	4.9	51.1
Limburg (B)	787	17.6	68.9	13.5	93.1	5.0	1.9	55.6
Oost-Vlaanderen	1 360	16.7	66.5	16.9	96.3	0.9	2.8	52.9
Vlaams Brabant	1 012	17.1	66.3	16.6	94.3	4.3	1.4	46.0
West-Vlaanderen	1 127	17.2	65.1	17.8	98.9	0.6	0.5	50.4
Brabant Wallon	347	19.8	65.6	14.6	93.5	5.0	1.5	38.9
Hainaut	1 280	18.2	64.6	17.2	86.7	10.4	2.9	57.4
Liège	1 018	18.1	64.7	17.2	90.2	8.5	1.3	52.6
Luxemburg (B)	245	20.5	63.4	16.1	94.9	4.1	.	58.2
Namur	441	19.1	64.6	16.3	96.1	2.6	1.3	51.0
DANMARK	5 283	17.9	66.6	15.5	96.5	0.7	2.8	26.0
DEUTSCHLAND	80 908	15.4	68.2	16.4	91.3	2.3	6.5	27.0
Stuttgart	3 858	17.2	67.8	15.0	84.9	5.2	9.9	29.9
Karlsruhe	2 618	15.7	66.5	17.7	87.9	3.3	8.7	27.8
Freiburg	2 079	17.7	67.4	14.9	90.6	3.4	6.0	30.5
Tübingen	1 721	17.6	67.4	15.0	89.5	3.1	7.4	30.5
Oberbayern	3 955	15.3	69.8	15.0	87.0	4.9	8.2	25.6
Niederbayern	1 151	16.0	68.6	15.4	94.8	0.8	4.4	35.1
Oberplatz	1 060	16.6	67.2	16.2	95.6	0.9	3.5	35.3
Oberfranken	1 098	16.6	66.7	16.6	94.8	1.0	4.2	30.5
Mittelfranken	1 648	15.1	67.2	17.7	89.3	3.2	7.5	31.7
Unterfranken	1 308	16.8	67.6	15.6	93.2	1.5	5.3	31.5
Schwaben	1 710	16.8	67.1	16.2	90.4	2.3	7.3	27.8
Berlin-West, Stadt	2 084	13.9	71.0	15.1	83.1	1.9	14.9	26.0
Berlin-Ost, Stadt	1 257	13.3	73.5	13.2	94.0	0.9	5.1	14.1
Brandenburg	2 560	14.2	71.0	14.8	99.3	.	0.6	18.3
Bremen	663	13.6	68.5	17.9	86.2	2.1	11.6	31.3
Hamburg	1 693	13.3	70.1	16.7	84.8	3.3	11.9	26.3
Darmstadt	3 670	16.1	68.6	15.3	84.7	4.2	11.1	25.7
Gießen	1 033	16.3	67.0	16.7	91.2	1.7	7.1	28.9
Kassel	1 264	17.0	66.0	17.0	93.6	1.1	5.3	29.1
Mecklenburg-Vorpommern	1 765	14.7	69.9	15.4	99.6	.	.	21.0
Braunschweig	1 662	15.3	67.5	17.2	92.6	1.9	5.5	25.8
Hannover	2 118	15.4	66.7	17.9	91.5	1.7	6.8	28.7
Lüneburg	1 630	16.0	67.0	16.9	94.7	1.4	3.9	27.2
Weser-Ems	2 372	17.3	67.0	15.7	94.6	1.1	4.2	30.3
Düsseldorf	5 185	14.6	68.2	17.2	87.1	3.1	9.8	30.4
Köln	4 206	14.9	68.9	16.3	87.1	3.6	9.3	29.9
Münster	2 565	16.5	67.6	15.9	91.4	1.4	7.2	29.8
Detmold	2 024	16.1	66.6	17.3	91.8	2.1	6.0	29.4
Arnsberg	3 772	15.8	66.9	17.3	88.4	2.7	8.8	31.0
Koblenz	1 495	15.4	67.6	17.0	94.1	1.3	4.7	31.5
Trier	505	15.6	66.5	17.9	94.9	.	3.6	32.8
Rheinessen-Pfalz	1 974	15.5	67.7	16.7	90.8	2.8	6.4	31.9
Saarland	1 045	13.5	68.0	18.5	92.4	2.9	4.7	30.2
Sachsen	4 423	13.8	68.0	18.2	99.3	.	0.7	15.7
Dessau	552	13.0	69.5	17.5	99.2	.	.	20.8
Halle	867	13.6	68.7	17.7	99.3	.	.	18.8
Magdeburg	1 204	13.4	68.1	18.5	99.2	.	0.8	20.1
Schleswig-Holstein	2 715	15.8	67.5	16.7	94.6	1.4	4.0	26.3
Thüringen	2 400	13.9	69.8	16.4	99.4	.	0.6	16.4
ELLADA ⁽¹⁾	10 289	15.3	67.4	17.4	97.2	0.2	2.7	58.7
Anatoliki Makedonia, Thraki	537	15.8	66.7	17.5	99.0	.	1.0	71.1
Kentriki Makedonia	1 740	14.8	69.0	16.2	97.9	.	2.0	59.1
Dytiiki Makedonia	274	17.2	64.4	18.4	98.9	.	(1.1)	68.0
Thessalia	730	16.4	65.5	18.2	98.8	.	1.1	69.6
Ipeiros	291	13.3	65.1	21.6	98.9	.	(1.1)	70.5
Ionia Nisia	176	14.4	63.7	21.9	96.5	.	3.3	71.8
Dytiki Ellada	642	17.1	63.8	19.2	98.4	.	1.5	68.0
Stereia Ellada	497	13.6	65.6	20.9	99.3	.	(0.7)	74.9

⁽¹⁾ 1998.

Table 12

Main characteristics of population and households by region

UPPER SECONDARY (% all Pop.)	THIRD LEVEL EDUCAT. (% all Pop.)	EMPLOY- ED (% all Pop.)	UNEM- PLOYED (% all Pop.)	INACTIVE (% all Pop.)	NUMBER OF HOUSE- HOLDS (Thousands)	SINGLE PERSON HOUSEHO. (% all Hous.)	HOUSEHO. ALL AGED 65 YRS &+ (% all Hous.)	REGION
28.6	20.0	39.0	3.7	57.3	4 233	29.5	22.8	BELGIQUE-BELGIE
26.4	26.5	35.5	6.7	57.9	464	45.7	23.4	BruxellesCap-BrusselsHfgewest
29.1	19.8	39.6	2.8	57.6	679	29.4	22.9	Antwerpen
29.5	14.9	40.0	2.9	57.1	294	19.2	17.2	Limburg (B)
28.8	18.3	41.9	2.9	55.2	559	27.2	23.0	Oost-Vlaanderen
29.4	24.6	43.9	1.7	54.4	405	25.7	22.5	Vlaams Brabant
30.6	19.0	41.8	1.8	56.4	469	26.5	24.5	West-Vlaanderen
31.8	29.3	39.6	3.4	57.0	133	26.7	21.3	Brabant Wallon
26.6	16.1	33.1	6.3	60.6	524	29.4	23.4	Hainaut
28.3	19.1	37.0	5.0	58.0	433	31.6	23.3	Liège
25.2	16.6	38.8	2.8	58.4	96	30.0	21.9	Luxemburg (B)
28.4	20.6	37.4	4.1	58.4	178	25.6	23.5	Namur
51.7	22.3	51.3	2.8	46.0	-	-	-	DANMARK
53.9	19.1	44.6	4.3	51.1	37 308	34.9	20.9	DEUTSCHLAND
49.9	20.2	47.9	2.7	49.5	1 714	33.4	19.8	Stuttgart
50.6	21.5	45.3	3.0	51.7	1 233	37.1	23.5	Karlsruhe
51.4	18.1	46.2	2.6	51.2	947	37.1	19.6	Freiburg
50.3	19.2	47.3	2.3	50.4	739	33.3	20.0	Tübingen
51.0	23.4	50.9	2.1	47.0	1 846	37.1	18.1	Oberbayern
52.9	12.0	48.8	2.5	48.7	483	29.5	19.1	Niederbayern
51.8	12.9	47.4	2.3	50.3	441	29.3	19.9	Oberpfalz
54.4	15.1	46.5	3.1	50.3	470	31.0	21.8	Oberfranken
50.1	18.3	46.6	3.3	50.0	770	37.0	21.9	Mittelfranken
53.8	14.7	46.0	3.1	50.9	556	30.5	20.2	Unterfranken
55.1	17.1	48.4	2.3	49.2	745	32.0	20.4	Schwaben
50.2	23.7	41.3	7.7	50.9	1 110	47.5	19.3	Berlin-West, Stadt
49.8	36.1	47.5	8.0	44.5	654	43.8	15.7	Berlin-Ost, Stadt
55.2	26.5	44.7	8.4	46.9	1 148	29.3	18.2	Brandenburg
54.0	14.7	41.4	5.4	53.3	349	45.4	21.8	Bremen
54.6	19.1	46.6	4.4	49.1	909	48.5	20.8	Hamburg
52.7	21.5	46.3	3.4	50.2	1 720	36.0	19.1	Darmstadt
54.0	17.1	43.4	3.5	53.1	447	30.2	20.1	Gießen
55.2	15.7	42.5	3.9	53.6	539	29.9	21.8	Kassel
54.7	24.3	42.9	9.5	47.6	791	31.0	19.6	Mecklenburg-Vorpommern
58.3	15.9	42.3	4.1	53.6	807	38.6	22.1	Braunschweig
54.3	17.0	43.3	3.8	52.9	1 009	37.8	22.7	Hannover
56.8	16.0	44.3	3.1	52.7	710	30.8	21.1	Lüneburg
56.0	13.7	43.3	3.0	53.7	1 030	32.4	20.9	Weser-Ems
53.8	15.8	42.2	3.5	54.3	2 492	36.2	21.5	Düsseldorf
51.3	18.8	43.4	3.2	53.4	1 994	36.3	20.3	Köln
56.3	13.9	41.5	3.4	55.0	1 132	32.7	20.3	Münster
56.7	13.9	43.7	3.0	53.3	910	35.3	22.7	Detmold
55.4	13.6	41.0	3.7	55.2	1 735	33.5	22.1	Arnsberg
52.9	15.6	43.5	2.8	53.7	652	29.5	21.9	Koblenz
52.2	15.0	42.7	2.6	54.7	221	31.8	21.9	Trier
51.2	16.9	45.2	3.0	51.8	898	34.5	21.3	Rheinhausen-Pfalz
56.1	13.7	41.8	3.2	55.0	498	36.9	24.4	Saarland
58.4	25.9	43.6	8.3	48.1	2 061	32.2	23.9	Sachsen
57.1	22.1	40.9	10.9	48.3	251	29.9	22.4	Dessau
59.1	22.1	39.6	11.3	49.1	396	31.1	22.2	Halle
56.5	23.4	41.9	10.3	47.8	565	32.4	23.4	Magdeburg
55.3	18.4	45.0	3.7	51.2	1 273	34.6	20.9	Schleswig-Holstein
58.3	25.3	45.4	7.7	46.8	1 063	30.0	22.4	Thüringen
29.2	12.1	38.6	4.6	56.8	3 833	21.2	19.3	ELLADA ⁽¹⁾
20.5	8.4	41.1	4.0	54.9	205	20.3	20.9	Anatoliki Makedonia, Thraki
28.7	12.3	38.0	4.4	57.6	646	20.5	17.6	Kentriki Makedonia
22.8	9.1	36.1	4.6	59.3	96	16.6	19.7	Dytiki Makedonia
20.4	10.1	38.9	4.7	56.4	250	15.3	17.2	Thessalia
20.5	9.0	34.7	5.4	59.8	110	19.6	23.1	Ipeiros
20.6	7.7	43.3	(1.7)	54.9	68	22.3	24.9	Ionian Nisia
24.1	7.9	37.0	4.5	58.5	221	18.3	20.4	Dytiki Ellada
19.7	5.5	36.6	5.4	58.0	185	19.4	23.5	Stereia Ellada

(1) 1998.

Table 12

Main characteristics of population and households by region

REGION	TOTAL POPULATION (Thousands)	POPULATION AGED 0-14 (% all Pop.)	POPULATION AGED 15-64 (% all Pop.)	POPULATION AGED 65 & MORE (% all Pop.)	NATION. (% all Pop.)	EU-NATION. (% all Pop.)	NON-EU - NON-NATION. (% all Pop.)	LESS UPPER SECONDARY (% all Pop.)
Peloponnisos	527	15.4	60.4	24.2	98.6	.	1.3	70.1
Attiki	3 903	14.8	69.9	15.3	95.1	0.3	4.6	45.1
Voreio Aigaio	180	15.1	62.6	22.3	99.3	.	.	69.7
Notio Aigaio	251	17.9	67.3	14.8	99.3	.	.	72.9
Kriti	540	16.4	65.6	18.0	97.8	.	2.0	67.6
ESPAÑA	39 032	15.2	66.9	17.9	99.0	0.4	0.6	68.1
Galicia	2 690	12.9	65.5	21.6	99.6	0.3	(0.1)	72.3
Principado de Asturias	1 046	11.2	67.2	21.6	99.6	.	.	69.6
Cantabria	520	13.2	67.3	19.4	100.0	.	.	67.2
Pais Vasco	2 027	12.2	69.3	18.5	99.5	0.3	(0.2)	59.2
Comunidad Foral de Navarra	522	13.3	66.1	20.5	99.7	.	.	63.6
La Rioja	255	13.4	65.3	21.2	98.9	.	.	70.5
Aragón	1 158	13.4	65.4	21.2	99.4	(0.3)	(0.3)	68.1
Comunidad de Madrid	4 983	14.6	70.4	15.1	98.3	0.3	1.4	57.0
Castilla y León	2 451	12.7	65.6	21.7	99.6	0.2	(0.2)	68.4
Castilla-la Mancha	1 694	16.7	63.3	20.0	99.6	.	0.4	77.2
Extremadura	1 073	17.6	62.7	19.7	99.6	(0.3)	.	77.4
Cataluna	6 003	14.2	65.9	19.9	98.7	0.3	1.0	66.6
Comunidad Valenciana	3 906	15.4	66.6	17.9	98.7	0.9	0.4	70.5
Islas Baleares	732	16.8	65.6	17.6	97.4	1.6	1.0	72.5
Andalucia	7 155	18.2	66.8	14.9	99.5	0.3	0.2	72.3
Región de Murcia	1 095	18.7	67.2	14.1	98.7	.	1.1	69.8
Ceuta e Melilla	136	21.5	68.6	9.8	96.8	.	(3.1)	63.5
Canarias	1 586	17.6	69.8	12.6	98.0	1.2	0.9	70.1
FRANCE	57 417	19.2	65.3	15.4	94.2	1.9	3.9	48.6
Île de France	11 165	20.7	67.8	11.5	87.4	4.0	8.6	42.1
Champagne-Ardenne	1 255	18.2	65.5	16.2	96.7	1.4	1.9	56.1
Picardie	1 747	20.6	65.1	14.3	94.6	1.4	3.9	55.8
Haute-Normandie	1 862	21.4	64.0	14.6	97.3	0.6	2.1	54.4
Centre	2 282	18.8	63.9	17.4	95.6	1.5	2.9	51.4
Basse-Normandie	1 290	17.5	63.3	19.2	99.2	(0.5)	(0.3)	55.9
Bourgogne	1 570	17.9	64.1	18.0	97.1	1.5	1.4	51.2
Nord - Pas-de-Calais	4 080	22.6	64.5	13.0	96.5	0.9	2.5	55.0
Lorraine	2 254	19.0	66.1	14.9	95.4	2.1	2.5	49.1
Alsace	1 685	19.7	67.9	12.4	93.1	2.2	4.8	42.0
Franche-Comté	1 094	18.5	65.8	15.7	94.4	1.1	4.5	52.1
Pays de la Loire	3 238	20.1	64.8	15.1	98.6	0.4	1.0	48.4
Bretagne	3 000	19.7	63.7	16.6	99.0	0.4	0.6	46.7
Poitou-Charentes	1 583	17.2	63.1	19.7	99.0	(0.4)	0.6	52.3
Aquitaine	3 003	17.3	63.9	18.8	96.9	2.0	1.1	47.9
Midi-Pyrénées	2 421	16.5	64.3	19.2	96.5	1.4	2.1	46.1
Limousin	663	14.8	62.0	23.2	97.7	(1.0)	(1.2)	51.8
Rhône-Alpes	5 388	19.6	66.4	14.0	93.1	2.4	4.6	45.2
Auvergne	1 235	14.3	65.1	20.6	97.3	1.4	1.2	50.8
Languedoc-Roussillon	2 062	17.2	64.3	18.5	93.4	2.1	4.5	52.8
Provence-Alpes-Côte d'Azur	4 269	17.8	64.5	17.7	93.7	1.7	4.6	50.3
Corse	271	17.3	62.4	20.3	82.4	(2.5)	15.1	73.5
Guadeloupe	-	-	-	-	-	-	-	-
Martinique	-	-	-	-	-	-	-	-
Guyane	-	-	-	-	-	-	-	-
Réunion	-	-	-	-	-	-	-	-
IRELAND	3 745	22.1	66.6	11.3	96.8	2.4	0.8	54.9 ⁽²⁾
Border, Midlands and Western	987	22.7	64.3	13.0	97.1	2.4	0.5	-
Southern and Eastern	2 758	21.9	67.4	10.6	96.7	2.4	0.9	-
ITALIA	56 912	14.6	67.9	17.5	99.3	0.1	0.6	61.6
Piemonte	4 222	12.1	68.3	19.6	99.1	.	0.8	63.9
Valle d'Aosta	118	12.7	69.2	18.1	98.7	.	.	63.8
Liguria	1 612	10.4	65.5	24.1	99.2	.	0.7	61.1
Lombardia	8 915	13.2	70.0	16.8	98.6	0.2	1.2	60.4
Trentino - Alto Adige	914	16.0	68.0	16.0	99.2	.	(0.5)	59.9
Veneto	4 425	13.4	69.5	17.1	99.0	.	1.0	63.1

⁽²⁾ 1997.

Table 12

Main characteristics of population and households by region

UPPER SECONDARY (% all Pop.)	THIRD LEVEL EDUCAT. (% all Pop.)	EMPLOYED (% all Pop.)	UNEMPLOYED (% all Pop.)	INACTIVE (% all Pop.)	NUMBER OF HOUSEHOLDS (Thousands)	SINGLE PERSON HOUSEHO. (% all Hous.)	HOUSEHO. ALL AGED 65 YRS &+ (% all Hous.)	REGION
22.1	7.8	39.5	3.5	57.0	197	20.2	25.2	Peloponnisos
38.3	16.6	38.3	5.3	56.4	1 493	23.9	17.4	Attiki
21.2	9.0	33.4	4.0	62.6	71	23.3	27.4	Voreio Aigaio
21.4	5.6	39.8	2.7	57.5	89	17.6	18.9	Notio Aigaio
23.5	8.9	45.1	3.5	51.4	202	21.5	22.2	Kriti
16.1	15.9	35.3	6.6	58.1	12 771	14.3	19.7	ESPAÑA
15.0	12.7	34.7	6.8	58.5	857	14.1	19.5	Galicia
14.7	15.7	30.5	6.6	62.9	357	15.0	21.4	Principado de Asturias
17.1	15.7	32.7	5.9	61.4	162	12.9	18.9	Canabria
18.1	22.6	37.8	6.3	55.9	678	14.3	17.9	Pais Vasco
15.7	20.7	39.3	3.6	57.2	177	15.0	21.2	Comunidad Foral de Navarra
15.1	14.5	37.1	2.7	60.2	88	14.6	23.6	La Rioja
15.4	16.5	37.6	3.9	58.4	406	15.9	22.0	Aragón
20.2	22.8	38.8	5.8	55.4	1 606	13.8	17.1	Comunidad de Madrid
15.3	16.3	34.2	6.2	59.6	847	15.8	24.5	Castilla y León
11.8	11.0	33.4	6.0	60.7	551	12.7	23.6	Castilla-la Mancha
11.4	11.2	29.0	9.5	61.5	347	14.6	23.0	Extremadura
17.6	15.8	39.8	4.7	55.5	2 119	16.2	22.5	Cataluna
15.4	14.1	36.7	5.9	57.4	1 324	15.4	20.3	Comunidad Valenciana
15.7	11.8	41.1	3.1	55.8	254	16.4	20.5	Islas Baleares
14.1	13.6	28.9	10.3	60.8	2 153	12.1	16.9	Andalucia
15.7	14.5	34.9	5.7	59.4	328	11.3	17.0	Región de Murcia
20.3	16.2	30.4	9.9	59.7	37	11.5	11.3	Ceuta e Melilla
16.3	13.6	36.8	6.0	57.2	479	12.9	11.9	Canarias
34.7	16.7	39.6	5.4	54.9	24 076	30.6	21.1	FRANCE
32.0	25.9	43.9	5.2	50.9	4 685	33.2	16.7	Île de France
32.8	11.1	38.2	5.8	56.0	522	29.4	21.7	Champagne-Ardenne
32.5	11.7	38.4	6.0	55.5	674	24.1	21.0	Picardie
33.4	12.2	38.5	6.4	55.1	750	28.1	22.5	Haute-Normandie
35.3	13.3	40.9	5.0	54.1	969	28.6	23.1	Centre
31.7	12.4	39.1	4.4	56.6	544	28.2	25.8	Basse-Normandie
35.9	12.9	40.1	4.7	55.2	688	32.7	24.0	Bourgogne
33.2	11.7	32.9	7.3	59.8	1 503	24.3	20.2	Nord - Pas-de-Calais
36.6	14.3	38.8	4.9	56.3	921	27.5	20.1	Lorraine
42.6	15.4	44.6	3.7	51.7	682	27.5	17.1	Alsace
34.2	13.7	41.2	4.5	54.4	462	31.2	20.9	Franche-Comté
38.4	13.2	40.3	5.7	54.0	1 353	30.5	21.2	Pays de la Loire
38.1	15.2	39.4	4.2	56.4	1 250	29.8	22.6	Bretagne
34.8	12.9	39.7	4.9	55.4	687	29.8	25.2	Poitou-Charentes
36.6	15.6	38.6	5.2	56.2	1 293	30.1	23.6	Aquitaine
36.0	17.9	39.4	5.0	55.6	1 083	35.2	22.7	Midi-Pyrénées
36.3	11.9	38.0	4.0	58.0	301	32.5	28.5	Limousin
36.3	18.5	41.6	4.7	53.7	2 205	28.4	19.1	Rhône-Alpes
34.8	14.3	38.7	4.6	56.6	547	30.5	26.3	Auvergne
32.2	15.0	33.8	7.2	59.0	932	34.8	23.3	Languedoc-Roussillon
33.4	16.4	35.7	7.3	56.9	1 903	34.6	23.4	Provence-Alpes-Côte d'Azur
18.4	8.1	26.7	9.6	63.7	122	42.4	27.6	Corse
-	-	-	-	-	-	-	-	Guadeloupe
-	-	-	-	-	-	-	-	Martinique
-	-	-	-	-	-	-	-	Guyane
-	-	-	-	-	-	-	-	Réunion
27.0 ⁽²⁾	18.0 ⁽²⁾	42.5	2.6	54.9	1 192 ⁽²⁾	22.6 ⁽²⁾	15.2 ⁽²⁾	IRELAND
-	-	39.6	2.9	57.5	-	-	-	Border, Midlands and Western
-	-	43.6	2.5	54.0	-	-	-	Southern and Eastern
31.1	7.3	36.2	4.8	59.0	21 470	23.8	21.8	ITALIA
30.0	6.1	40.7	3.4	55.9	1 780	28.8	24.2	Piemonte
30.2	(6.0)	44.0	.	53.4	52	31.7	21.5	Valle d'Aosta
31.5	7.4	36.8	4.3	58.9	741	36.2	28.0	Liguria
31.8	7.8	43.0	2.2	54.8	3 568	26.0	21.2	Lombardia
34.5	5.6	43.8	1.7	54.5	345	26.1	18.9	Trentino - Alto Adige
30.4	6.5	42.5	2.2	55.3	1 654	22.4	19.8	Veneto

⁽²⁾ 1997.

Table 12

Main characteristics of population and households by region

REGION	TOTAL POPULATION (Thousands)	POPULATION AGED 0-14 (% all Pop.)	POPULATION AGED 15-64 (% all Pop.)	POPULATION AGED 65 & MORE (% all Pop.)	NATION. (% all Pop.)	EU-NATION. (% all Pop.)	NON-EU - NON-NATION. (% all Pop.)	LESS UPPER SECONDARY (% all Pop.)
Friuli - Venezia Giulia	1 166	11.3	68.1	20.7	99.3	.	(0.5)	61.7
Emilia-Romagna	3 912	11.2	67.2	21.6	99.3	.	0.7	60.1
Toscana	3 482	11.6	66.8	21.5	99.1	0.2	0.6	63.5
Umbria	823	12.4	65.8	21.7	99.5	.	.	56.9
Marche	1 440	13.0	66.1	20.8	99.4	.	0.5	62.4
Lazio	5 178	13.8	69.5	16.7	99.5	.	0.5	53.4
Abruzzo	1 264	14.8	65.9	19.4	99.7	.	.	59.6
Molise	326	15.1	64.8	20.1	99.7	.	.	61.9
Campania	5 740	19.8	66.8	13.4	99.9	.	.	63.8
Puglia	4 046	17.8	67.5	14.6	99.6	.	0.4	64.8
Basilicata	602	16.9	65.9	17.1	99.9	.	.	63.2
Calabria	2 045	17.9	66.2	15.8	99.8	.	.	60.2
Sicilia	5 050	18.7	65.7	15.6	99.9	.	(0.1)	64.6
Sardegna	1 634	15.2	70.1	14.7	99.8	.	.	66.8
LUXEMBOURG (Grand-Duché)	424	18.7	67.2	14.1	63.4	32.1	4.5	43.9
NEDERLAND	15 544	18.8	68.5	12.8	95.8	1.5	2.7	42.4
Groningen	552	17.0	69.3	13.7	98.0	.	(1.4)	42.7
Friesland	613	19.3	67.3	13.5	98.3	.	(1.2)	46.9
Drenthe	459	18.8	67.0	14.2	98.1	.	(1.7)	49.4
Overijssel	1 057	19.6	67.5	12.9	97.6	(0.5)	1.9	46.0
Gelderland	1 877	19.1	68.2	12.6	97.4	0.6	2.0	42.7
Flevoland	308	24.0	67.3	8.7	96.0	(1.7)	(2.3)	45.8
Utrecht	1 083	19.2	69.2	11.6	95.8	(0.8)	3.4	35.8
Noord-Holland	2 470	17.9	69.3	12.8	93.8	2.3	3.9	38.5
Zuid-Holland	3 336	18.8	68.1	13.1	94.3	2.0	3.7	40.5
Zeeland	364	18.8	65.9	15.3	96.2	(2.5)	(1.3)	49.1
Noord-Brabant	2 306	18.8	69.3	11.9	96.7	1.1	2.2	44.3
Limburg (NL)	1 118	17.5	69.1	13.4	94.9	3.0	2.1	46.1
ÖSTERREICH	7 921	17.4	67.5	15.1	91.3	1.1	7.6	33.8
Burgenland	274	15.7	66.5	17.8	95.8	.	3.7	43.2
Niederösterreich	1 507	17.3	66.6	16.1	94.4	0.5	5.1	36.5
Wien	1 571	15.4	69.0	15.6	82.8	1.8	15.4	26.1
Kärnten	556	17.4	66.6	15.9	94.7	1.0	4.2	31.4
Steiermark	1 182	16.8	66.9	16.3	95.5	0.6	3.9	34.4
Oberösterreich	1 340	18.7	66.9	14.4	93.7	0.9	5.4	37.9
Salzburg	502	18.6	68.3	13.1	88.5	1.7	9.8	31.1
Tirol	649	19.2	67.9	12.9	91.4	2.1	6.5	35.5
Vorarlberg	339	20.0	68.2	11.8	86.7	1.9	11.4	38.8
PORTUGAL	9 973	17.1	67.9	15.0	98.8	0.3	0.8	79.1
Norte	3 576	18.9	68.6	12.5	99.3	0.2	0.5	83.7
Centro (P)	1 705	16.1	66.0	17.9	98.8	0.6	0.6	79.9
Lisboa e Vale do Tejo	3 336	15.6	69.2	15.2	98.3	0.3	1.4	72.6
Alentejo	496	14.5	64.2	21.3	99.3	.	.	83.2
Algarve	360	16.1	65.5	18.4	98.6	.	(0.7)	82.0
Açores	244	23.4	64.5	12.1	99.3	.	.	87.3
Madeira	256	20.6	67.3	12.1	98.9	.	.	83.8
SUOMI/FINLAND ⁽³⁾	5 142	18.4	66.9	14.7	98.9	0.2	1.0	34.6
Itä-Suomi	-	-	-	-	-	-	-	-
Väli-Suomi	-	-	-	-	-	-	-	-
Pohjois-Suomi	-	-	-	-	-	-	-	-
Uusimaa	-	-	-	-	-	-	-	-
Etelä-Suomi	-	-	-	-	-	-	-	-
Ahvenanmaa/Åland	-	-	-	-	-	-	-	-
SVERIGE ⁽³⁾	8 844	18.5	64.1	17.4	95.3	1.3	3.4	29.8
Stockholm	-	-	-	-	-	-	-	-
Östra Mellansverige	-	-	-	-	-	-	-	-
Sydsverige	-	-	-	-	-	-	-	-
Norra Mellansverige	-	-	-	-	-	-	-	-
Mellersta Norrland	-	-	-	-	-	-	-	-

⁽³⁾ Regional distribution of the population aged less than 15 years (and, for Sweden, more than 75 years), not provided.

Table 12

Main characteristics of population and households by region

UPPER SECONDARY (% all Pop.)	THIRD LEVEL EDUCAT. (% all Pop.)	EMPLOYED (% all Pop.)	UNEMPLOYED (% all Pop.)	INACTIVE (% all Pop.)	NUMBER OF HOUSEHOLDS (Thousands)	SINGLE PERSON HOUSEHO. (% all Hous.)	HOUSEHO. ALL AGED 65 YRS &+ (% all Hous.)	REGION
32.2	6.1	40.6	2.3	57.0	481	27.9	24.2	Friuli – Venezia Giuglia
31.9	8.0	44.0	2.2	53.8	1 602	26.2	24.4	Emilia-Romagna
29.7	6.8	39.2	3.4	57.4	1 361	23.6	24.4	Toscana
34.6	8.6	38.4	2.9	58.8	306	21.6	24.2	Umbria
29.6	8.0	40.2	2.7	57.1	542	22.3	24.0	Marche
36.8	9.8	36.1	5.4	58.6	1 945	21.4	20.4	Lazio
33.5	6.9	34.5	4.0	61.5	465	23.3	24.1	Abruzzo
30.4	7.6	32.3	6.3	61.4	119	22.4	26.0	Molise
29.2	7.0	27.2	8.2	64.6	1 868	18.5	18.6	Campania
28.6	6.7	29.1	7.0	63.9	1 359	18.6	19.8	Puglia
31.4	5.4	29.3	6.0	64.7	210	20.1	23.0	Basilicata
32.7	7.1	25.9	10.1	64.0	715	23.4	22.3	Calabria
27.9	7.5	26.1	8.4	65.5	1 787	21.0	21.0	Sicilia
27.4	5.8	31.5	8.6	59.9	570	22.6	17.1	Sardegna
41.4	14.6	41.5	1.0	57.5	163	25.0	16.0	LUXEMBOURG (Grand-Duché)
39.4	18.3	48.9	1.8	49.2	6 793	32.4	18.0	NEDERLAND
39.6	17.7	46.4	3.3	50.3	259	38.2	18.1	Groningen
39.7	13.4	47.3	2.0	50.6	263	30.6	19.6	Friesland
37.1	13.5	44.5	4.1	51.4	193	26.2	20.9	Drenthe
39.1	14.9	48.1	1.5	50.4	437	28.5	19.0	Overijssel
38.6	18.6	48.9	1.7	49.3	788	28.7	17.9	Gelderland
40.2	14.0	49.0	(2.0)	48.9	118	19.0	11.9	Flevoland
41.1	23.1	51.7	1.4	46.9	478	35.3	16.7	Utrecht
40.7	20.8	50.0	1.9	48.1	1 166	39.1	17.5	Noord-Holland
39.6	19.9	48.5	1.7	49.8	1 502	35.6	18.5	Zuid-Holland
39.0	11.9	45.6	2.9	51.5	152	26.9	22.3	Zeeland
38.4	17.3	50.2	1.4	48.4	961	27.4	16.8	Noord-Brabant
38.1	15.8	48.4	1.6	50.0	479	28.4	18.7	Limburg (NL)
59.5	6.6	46.4	2.3	51.3	3 235	30.3	18.7	ÖSTERREICH
53.3	3.5	45.2	2.3	52.5	102	22.6	21.2	Burgenland
58.0	5.4	46.0	2.1	51.9	575	24.9	19.6	Niederösterreich
62.5	11.4	48.0	3.4	48.5	789	42.9	19.7	Wien
64.1	4.5	43.8	1.8	54.4	215	27.7	19.6	Kärnten
60.2	5.4	45.2	2.0	52.8	459	26.7	18.4	Steiermark
57.0	5.1	46.3	2.3	51.4	521	27.0	18.8	Oberösterreich
61.5	7.4	48.7	1.5	49.8	201	29.5	16.5	Salzburg
58.7	5.9	46.9	1.6	51.6	245	24.4	15.5	Tirol
55.9	5.4	46.7	2.2	51.1	129	25.3	15.4	Vorarlberg
13.2	7.7	48.4	2.3	49.2	3 357	14.2	17.5	PORTUGAL
10.7	5.7	48.9	2.3	48.7	1 114	10.5	12.9	Norte
12.9	7.2	54.3	1.3	44.4	594	15.7	21.6	Centro (P)
16.5	10.9	47.0	3.0	50.0	1 199	16.4	18.1	Lisboa e Vale do Tejo
11.0	5.8	42.0	2.9	55.1	186	19.1	27.5	Alentejo
12.4	5.6	46.1	1.7	52.2	128	16.8	23.1	Algarve
8.5	4.2	39.3	(1.5)	59.2	66	9.7	12.1	Açores
12.3	3.8	44.7	(1.5)	53.7	70	10.4	11.4	Madeira
39.8	25.6	45.4	6.0	48.6	-	-	-	SUOMI/FINLAND ⁽³⁾
-	-	-	-	-	-	-	-	Uusimaa
-	-	-	-	-	-	-	-	Etelä-Suomi
-	-	-	-	-	-	-	-	Itä-Suomi
-	-	-	-	-	-	-	-	Väli-Suomi
-	-	-	-	-	-	-	-	Pohjois-Suomi
-	-	-	-	-	-	-	-	Ahvenanmaa/Åland
46.0	24.2	45.8	3.8	50.4	-	-	-	SVERIGE ⁽³⁾
-	-	-	-	-	-	-	-	Stockholm
-	-	-	-	-	-	-	-	Östra Mellansverige
-	-	-	-	-	-	-	-	Småland med Öarna
-	-	-	-	-	-	-	-	Sydsverige
-	-	-	-	-	-	-	-	Västsverige

⁽³⁾ Regional distribution of the population aged less than 15 years (and, for Sweden, more than 75 years), not provided.

Table 12

Main characteristics of population and households by region

REGION	TOTAL POPULATION (Thousands)	POPULATION AGED 0-14 (% all Pop.)	POPULATION AGED 15-64 (% all Pop.)	POPULATION AGED 65 & MORE (% all Pop.)	NATION. (% all Pop.)	EU-NATION. (% all Pop.)	NON-EU - NON-NATION. (% all Pop.)	LESS UPPER SECONDARY (% all Pop.)
Övre Norrland	-	-	-	-	-	-	-	-
Småland med Oeama	-	-	-	-	-	-	-	-
Västsverige	-	-	-	-	-	-	-	-
UNITED KINGDOM	58 256	19.8	65.0	15.2	96.2	1.5	2.3	19.6
Tees Valley & Durham	1 150	20.3	64.9	14.8	99.2	.	.	25.9
Northumbria, Tyne and Wear	1 423	19.2	64.2	16.6	98.8	.	0.9	21.3
Cumbria	484	16.7	66.8	16.6	99.5	.	.	17.5
Cheshire	978	18.4	66.9	14.7	98.8	.	.	16.7
Greater Manchester	2 567	20.9	65.4	13.7	96.8	1.4	1.8	21.2
Lancashire	1 404	21.2	63.0	15.7	98.0	0.9	1.1	20.1
Merseyside	1 403	21.0	63.3	15.8	98.2	0.8	0.9	26.7
East Riding & North Lincolnshire	888	19.8	64.8	15.3	99.0	.	.	21.4
North Yorkshire	726	18.0	64.1	17.8	98.9	.	.	18.1
South Yorkshire	1 292	19.5	65.6	14.9	98.7	.	.	22.9
West Yorkshire	2 098	20.8	64.5	14.6	96.6	1.0	2.4	20.0
Derbyshire, Nottinghamshire	1 994	18.9	64.7	16.4	98.7	0.5	0.8	21.6
Leicestershire, Northamptonshire	1 539	21.5	65.4	13.0	97.8	0.7	1.5	20.0
Lincolnshire	617	17.8	66.3	15.9	99.0	.	.	19.5
Herefordsh.,Worcestersh.&Warks	1 201	19.1	65.7	15.2	98.4	.	.	20.0
Shropshire, Staffordshire	1 480	19.2	65.8	14.9	98.4	0.8	0.7	20.8
West Midlands	2 588	21.3	63.7	14.9	95.2	1.8	3.0	27.3
East Anglia	2 161	19.1	64.4	16.6	97.0	1.1	1.9	19.6
Bedfordshire, Hertfordshire	1 549	20.8	65.5	13.7	95.4	2.1	2.5	14.0
Essex	1 566	18.5	65.3	16.3	97.9	1.0	1.1	19.4
Inner London	2 681	20.8	68.2	11.0	80.8	5.9	13.3	20.3
Outer London	4 296	20.2	66.1	13.7	89.4	3.7	6.9	17.4
Berkshire,Bucks,Oxfordshire	2 064	19.6	67.1	13.3	95.4	2.2	2.4	13.7
Surrey, East-West Sussex	2 453	19.3	63.1	17.6	96.2	1.7	2.1	12.9
Hampshire, Isle of Wight	1 714	19.0	64.9	16.1	97.5	1.3	1.2	15.4
Kent	1 537	20.3	64.2	15.5	97.9	1.0	1.1	16.8
Avon,Gloucestersh.,Wiltsh.&NS	2 126	19.0	64.5	16.5	97.7	1.3	1.0	15.2
Dorset, Somerset	1 162	16.6	62.4	21.0	98.0	1.1	.	17.0
Cornwall & Isles of Scilly	486	19.1	63.9	16.9	98.8	.	.	18.7
Devon	1 044	19.7	62.7	17.6	98.5	.	.	16.1
West Wales & the Valleys	1 833	19.0	63.8	17.2	99.2	.	.	24.7
East Wales	1 065	20.4	63.1	16.5	97.9	1.1	1.0	21.5
North Eastern Scotland	447	18.6	69.0	12.4	98.4	.	.	15.3
Eastern Scotland	1 871	19.1	65.2	15.6	98.6	0.7	0.7	17.0
South Western Scotland	2 308	19.6	65.9	14.5	96.6	1.4	1.9	22.5
Highlands, Islands	426	20.7	63.0	16.3	99.0	.	.	16.2
Northern Ireland	1 635	22.9	64.7	12.4	97.2	2.3	.	28.5

Table 12

Main characteristics of population and households by region

UPPER SECONDARY (% all Pop.)	THIRD LEVEL EDUCAT. (% all Pop.)	EMPLOYED (% all Pop.)	UNEMPLOYED (% all Pop.)	INACTIVE (% all Pop.)	NUMBER OF HOUSEHOLDS (Thousands)	SINGLE PERSON HOUSEHO. (% all Hous.)	HOUSEHO. ALL AGED 65 YRS &+ (% all Hous.)	REGION
--	--	--	--	--	--	--	--	Norra Mellansverige
--	--	--	--	--	--	--	--	Mellersta Norrland
--	--	--	--	--	--	--	--	Övre Norrland
55.9	24.5	46.5	3.1	50.4	25 316	29.6	20.6	UNITED KINGDOM
56.4	17.7	40.5	4.9	54.6	492	27.9	20.4	Tees Valley & Durham
60.3	18.5	40.0	4.4	55.6	634	29.0	23.9	Northumbria, Tyne and Wear
62.8	19.7	46.7	3.3	50.0	215	27.6	21.5	Cumbria
56.4	26.9	48.3	2.4	49.3	420	27.4	19.6	Cheshire
57.4	21.4	44.9	3.1	52.0	1 118	29.0	19.2	Greater Manchester
59.2	20.7	45.2	2.1	52.7	596	27.6	21.1	Lancashire
54.6	18.6	37.8	4.1	58.1	609	30.7	22.4	Merseyside
61.3	17.4	43.6	4.2	52.2	373	26.7	20.8	East Riding & North Lincolnshire
57.1	24.9	48.5	2.0	49.5	325	28.1	23.5	North Yorkshire
58.8	18.3	43.7	3.8	52.5	564	28.5	19.7	South Yorkshire
57.3	22.7	45.5	2.9	51.6	902	29.5	20.2	West Yorkshire
56.9	21.5	46.2	2.8	51.0	864	28.0	21.7	Derbyshire, Nottinghamshire
58.4	21.5	50.1	2.6	47.3	640	26.1	18.8	Leicestershire, Northamptonshire
59.3	21.2	48.5	2.4	49.1	270	27.2	21.4	Lincolnshire
55.0	25.0	50.8	2.6	46.5	507	25.0	20.1	Herefordsh., Worcestersh. & Warks
59.1	20.0	48.7	3.3	48.0	623	24.3	19.9	Shropshire, Staffordshire
54.0	18.7	42.8	4.0	53.2	1 079	29.6	21.3	West Midlands
57.0	23.4	48.9	2.1	49.0	928	28.8	22.2	East Anglia
59.4	26.6	50.5	2.2	47.3	647	27.2	17.9	Bedfordshire, Hertfordshire
60.6	20.0	49.6	2.3	48.0	686	28.6	21.7	Essex
38.4	41.3	44.6	4.8	50.6	1 320	42.6	13.7	Inner London
53.4	29.2	48.6	3.4	48.0	1 851	29.9	18.3	Outer London
53.2	33.1	54.1	1.4	44.5	886	29.6	18.3	Berkshire, Bucks, Oxfordshire
55.8	31.3	49.8	1.9	48.3	1 065	30.8	24.6	Surrey, East-West Sussex
58.2	26.4	50.2	2.5	47.3	746	27.5	21.5	Hampshire, Isle of Wight
61.9	21.4	48.4	2.3	49.2	666	29.4	20.6	Kent
57.1	27.8	51.4	1.8	46.8	938	29.2	21.5	Avon, Gloucestersh., Wiltsh. & NS
59.7	23.2	48.4	2.7	48.9	538	30.3	26.8	Dorset, Somerset
62.9	18.5	43.8	3.8	52.4	214	27.6	23.2	Cornwall & Isles of Scilly
60.2	23.7	46.5	3.3	50.2	467	30.7	22.9	Devon
55.1	20.1	40.3	3.4	56.3	809	28.0	23.2	West Wales & the Valleys
54.7	23.8	44.8	3.2	52.0	474	29.3	22.5	East Wales
54.0	30.7	54.7	2.9	42.3	199	31.3	16.1	North Eastern Scotland
55.1	27.9	46.8	3.3	49.9	845	31.9	20.6	Eastern Scotland
52.3	25.2	41.3	4.2	54.5	1 021	31.9	20.1	South Western Scotland
56.3	27.5	46.9	3.2	49.9	182	31.4	23.0	Highlands, Islands
52.2	19.3	41.4	3.3	55.4	600	26.1	19.4	Northern Ireland

EMPLOYMENT

GRAPH 5: Employment rates of population aged 15 to 64 years old (1999)

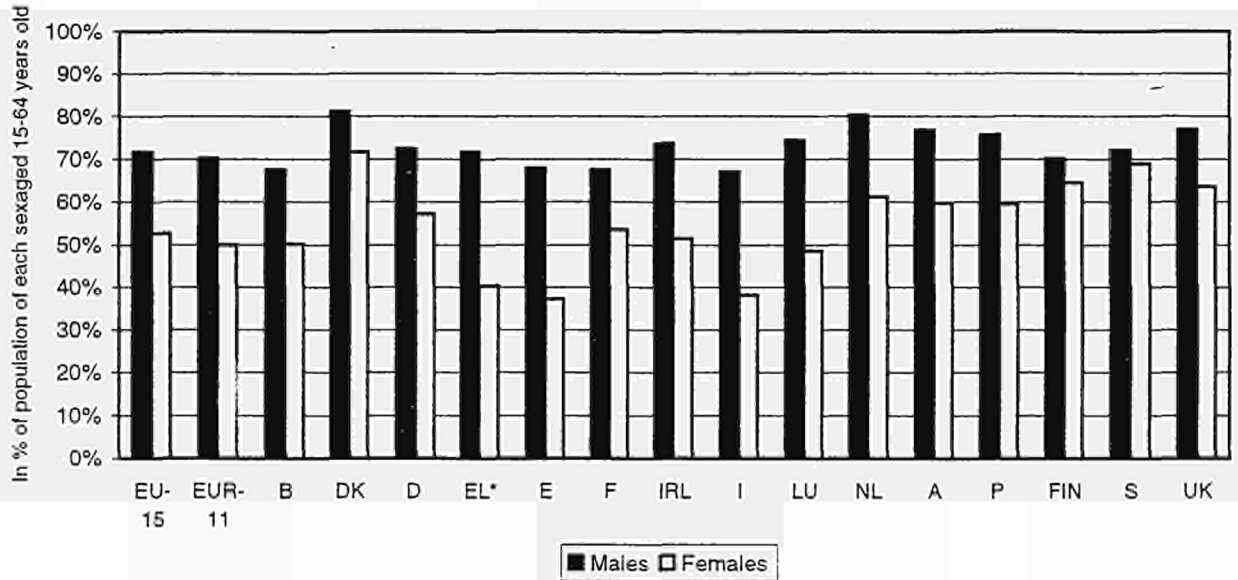

* 1998

GRAPH 6: Employment by professional status (1999)

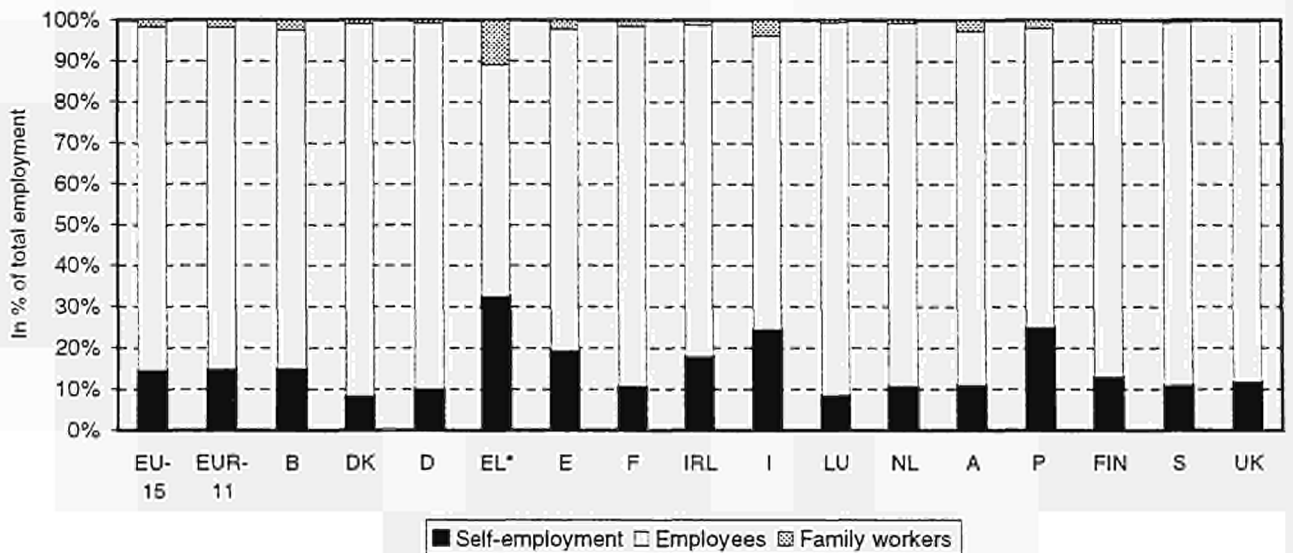

* 1998

GRAPH7: Employment by economic activity
(EU-15*, 1999)

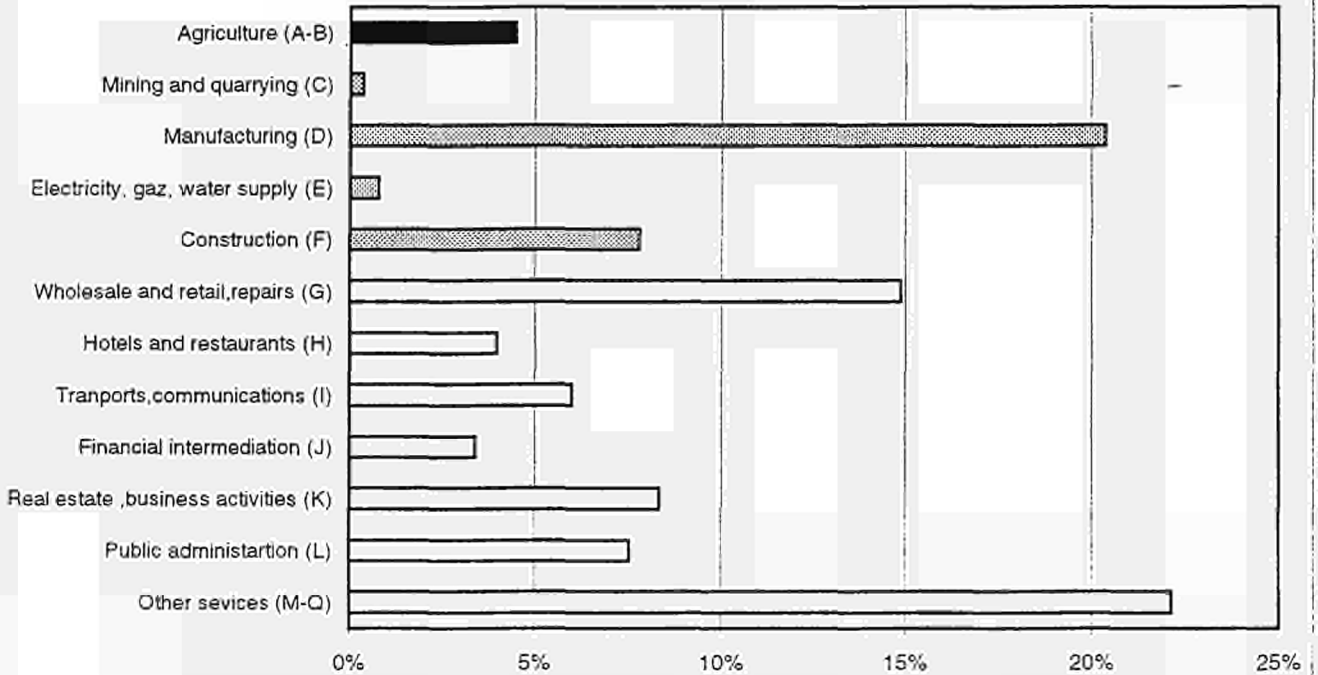

* Greece 1998

GRAPH 8: Temporary employees as percentage of total employees
(1999)

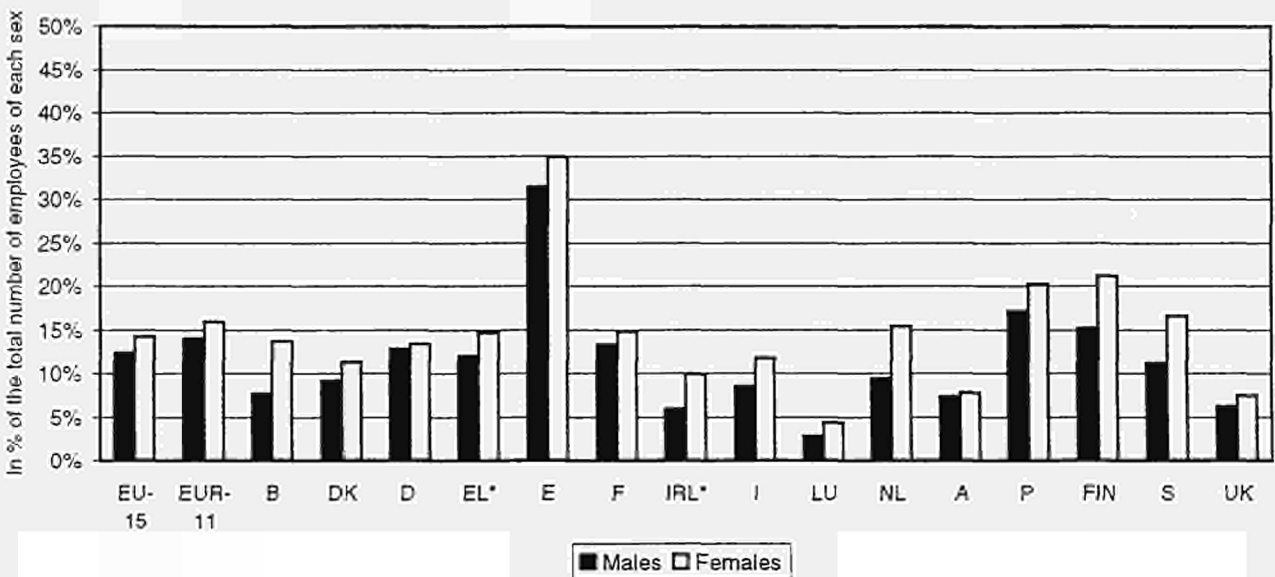

* 1998

GRAPH 9: Part-time as percentage of total employment
(1999)

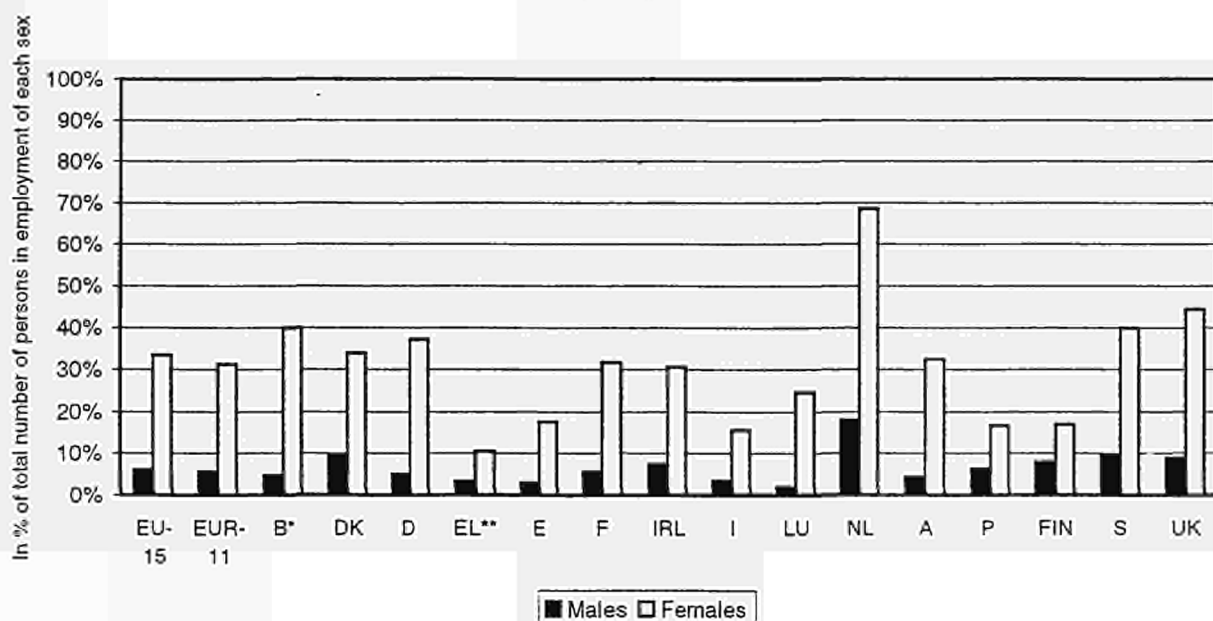

* Full-time/Part-time data only available for Employees

** 1998

GRAPH10 - Population in employment working usually from home, shift work, in the evening, at night, on Saturday and/or on Sunday
(EU-15*, 1999)



* Germany 1997, Greece 1998, Ireland 1997, Luxembourg 1998

GRAPH 11: Average weekly hours of work for all in employment
(1999)

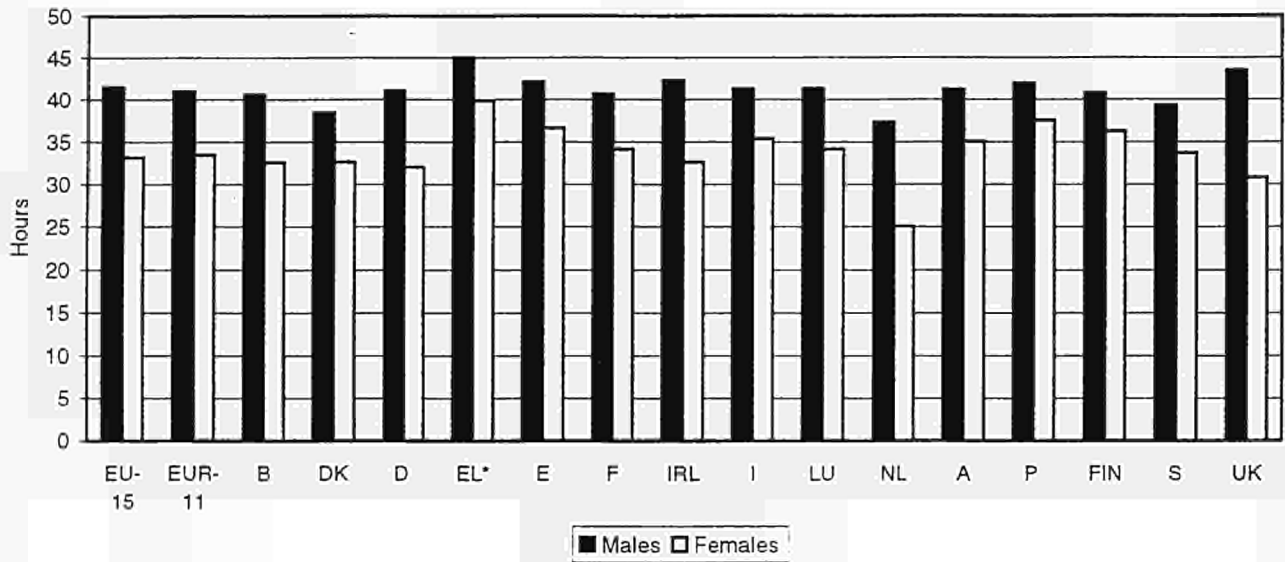

* 1998

GRAPH 12: Average weekly hours of work by type of employment
(1999)

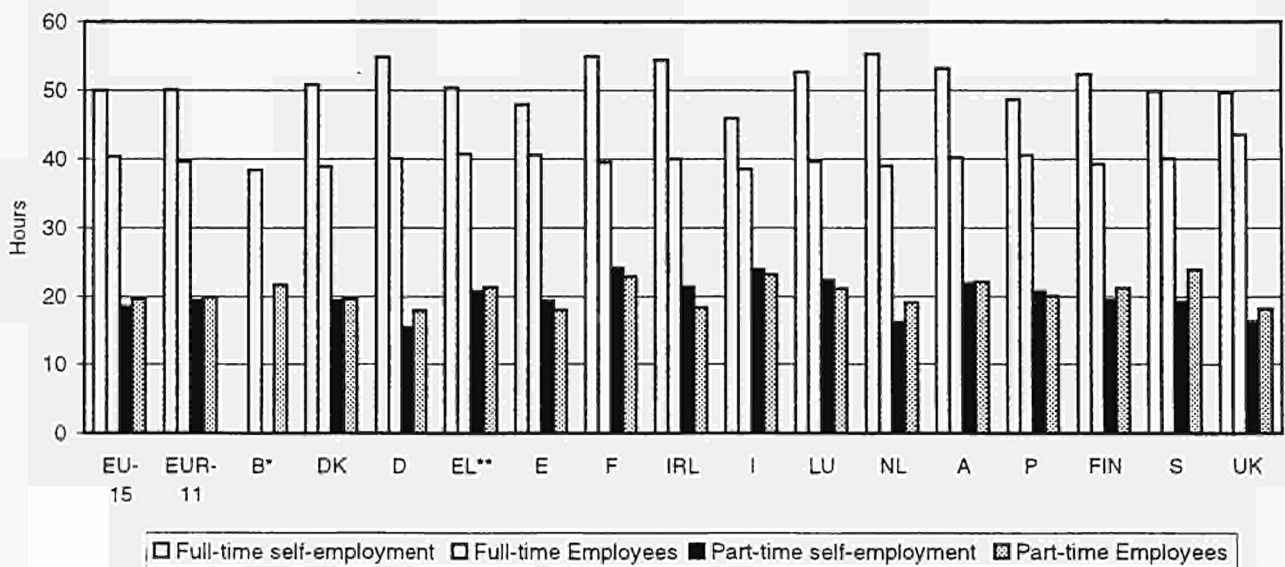

* Full-time/Part-time data only available for Employees

** 1998



EMPLOYMENT

Employment rates

Table 13

Employment rates by age group and nationality

* Rates for the Male and/or Female population in a given age group. Rates for the Male and/or Female population in a given age group and with a given nationality

	EU-15 ⁽²⁾	EUR-11	B	DK	D	EL ⁽¹⁾	E	F
Males and Females								
15-24 years*	38.7	35.6	25.5	66.0	46.2	28.1	29.2	26.5
Nationals	38.8	35.6	26.4	66.7	47.3	27.3	29.1	26.7
Non-Nationals/EU-Nationals	41.5	40.5	21.9	.	44.7	.	(36.0)	37.6
Non-National/NonEU-Nationals	33.7	33.5	11.4	46.6	37.7	50.2	37.6	18.6
25-49 years*	76.5	75.6	79.2	85.3	79.1	71.8	67.1	77.8
Nationals	77.4	76.5	81.9	86.6	81.0	71.8	67.1	79.4
Non-Nationals/EU-Nationals	76.2	76.2	70.4	84.8	77.5	56.7	63.5	77.1
Non-National/NonEU-Nationals	56.1	55.7	36.3	42.0	57.4	74.2	72.5	47.6
50-64 years*	48.6	45.4	38.5	65.5	48.2	45.9	43.1	47.0
Nationals	48.7	45.5	39.1	65.5	48.3	45.8	43.1	47.4
Non-Nationals/EU-Nationals	52.1	50.8	38.4	70.6	56.7	.	36.8	48.3
Non-National/NonEU-Nationals	40.5	39.6	16.4	56.9	40.9	54.0	55.0	37.4
65 & + years*	3.3	2.8	1.9	1.9	2.6	6.3	1.7	1.1
Nationals	3.3	2.8	1.9	1.9	2.6	6.3	1.6	1.0
Non-Nationals/EU-Nationals
Non-National/NonEU-Nationals
15-64 years*	62.1	60.1	58.9	76.5	64.8	55.6	52.3	60.4
Nationals	62.5	60.5	60.5	77.2	65.9	55.3	52.2	61.3
Non-Nationals/EU-Nationals	64.9	64.7	56.4	79.7	67.1	51.2	51.2	64.1
Non-National/NonEU-Nationals	49.0	48.3	27.5	45.0	50.0	66.7	64.2	40.4
Males								
15-24 years*	42.2	39.3	27.5	69.5	48.6	34.2	35.2	29.9
Nationals	42.3	39.3	28.0	70.0	49.5	33.0	35.2	29.9
Non-Nationals/EU-Nationals	43.9	44.3	29.1	.	47.3	.	.	45.5
Non-National/NonEU-Nationals	38.3	38.2	(15.1)	56.1	41.1	64.8	49.4	24.2
25-49 years*	87.0	86.9	88.0	89.9	87.1	90.2	84.7	86.7
Nationals	87.7	87.6	90.1	90.8	88.4	90.1	84.7	87.7
Non-Nationals/EU-Nationals	86.9	87.6	83.8	89.0	88.5	.	85.9	86.2
Non-National/NonEU-Nationals	71.0	71.3	51.7	54.4	72.3	90.5	87.3	65.6
50-64 years*	59.9	57.4	51.1	71.1	57.5	64.9	63.4	52.7
Nationals	60.2	57.6	51.7	71.3	57.7	64.8	63.5	53.1
Non-Nationals/EU-Nationals	60.0	60.0	53.5	.	65.8	.	51.4	52.5
Non-National/NonEU-Nationals	49.6	48.5	22.8	(59.7)	48.8	70.0	(63.7)	47.4
65 & + years*	5.2	4.5	3.4	2.9	4.2	9.6	2.5	1.7
Nationals	5.2	4.5	3.3	2.7	4.1	9.6	2.5	1.7
Non-Nationals/EU-Nationals
Non-National/NonEU-Nationals
15-64 years*	71.6	70.3	67.5	81.2	72.4	71.6	67.8	67.5
Nationals	71.9	70.6	68.6	81.8	73.2	71.3	67.8	68.1
Non-Nationals/EU-Nationals	73.9	74.4	69.8	76.3	76.4	75.7	65.6	71.6
Non-National/NonEU-Nationals	60.7	60.2	39.6	55.6	60.9	82.4	79.0	53.9
Females								
15-24 years*	35.1	31.9	23.4	62.8	43.9	22.2	23.1	23.3
Nationals	35.3	32.0	24.7	63.5	45.0	21.8	23.0	23.6
Non-Nationals/EU-Nationals	39.3	36.7	(14.5)	.	42.1	.	.	30.2
Non-National/NonEU-Nationals	29.6	29.2	(8.8)	(38.1)	34.2	34.5	30.1	13.5
25-49 years*	65.9	64.3	70.1	80.5	70.8	54.2	50.0	69.1
Nationals	67.0	65.3	73.6	82.2	73.5	54.1	50.0	71.2
Non-Nationals/EU-Nationals	64.7	63.5	54.3	81.7	64.5	(41.7)	46.4	66.9
Non-National/NonEU-Nationals	41.2	39.9	19.9	32.4	41.3	57.4	59.3	31.6
50-64 years*	37.6	33.8	26.2	59.5	38.9	28.1	24.3	41.5
Nationals	37.7	33.9	26.9	59.3	39.1	28.0	24.2	42.1
Non-Nationals/EU-Nationals	42.8	38.8	20.5	(81.3)	43.2	.	(20.0)	43.4
Non-National/NonEU-Nationals	27.9	26.3	.	(54.1)	30.0	(36.4)	(47.9)	18.2
65 & + years*	2.0	1.7	0.9	1.2	1.6	3.5	1.0	0.6
Nationals	1.9	1.7	0.9	1.3	1.6	3.5	1.0	0.6
Non-Nationals/EU-Nationals
Non-National/NonEU-Nationals
15-64 years*	52.6	50.0	50.2	71.6	57.1	40.3	37.3	53.5
Nationals	53.1	50.5	52.3	72.5	58.5	40.0	37.2	54.7
Non-Nationals/EU-Nationals	55.3	53.5	40.7	82.4	55.7	(38.8)	37.6	55.7
Non-National/NonEU-Nationals	36.8	35.5	15.4	36.3	37.8	50.1	52.0	26.2

(1) 1998.

(2) Greece 1998.

Table 13

Employment rates by age group and nationality
**Rates for the Male and/or Female population in a given age group. Rates for the Male and/or Female population in a given age group and with a given nationality*

IRL	I	L	NL	A	P	FIN	S	UK	
Males and Females									
46.5	25.5	31.7	62.7	54.9	43.3	45.0	35.4	55.0	15-24 years*
46.6	25.4	27.3	64.3	54.6	43.5	45.1	36.1	55.7	Nationals
51.6		38.8	53.2	50.5	.	.	.	46.6	Non-Nationals/EU-Nationals
	44.8	(24.7)	27.8	58.3	32.0	.	.	32.9	Non-National/NonEU-Nationals
75.1	68.6	78.4	82.5	82.6	82.3	80.9	81.4	80.3	25-49 years*
75.5	68.5	77.9	84.1	83.9	82.4	81.4	82.9	81.2	Nationals
71.7	72.4	81.5	79.3	84.2	74.7	(71.3)	81.5	75.0	Non-Nationals/EU-Nationals
53.3	73.6	61.6	38.5	70.6	76.7	51.7	46.7	57.9	Non-National/NonEU-Nationals
51.3	37.9	40.0	50.0	44.5	58.4	56.3	72.6	60.0	50-64 years*
51.3	37.8	38.3	50.4	44.0	58.4	56.4	73.6	60.2	Nationals
49.6	(54.1)	43.6	56.5	57.5	.	.	65.7	54.8	Non-Nationals/EU-Nationals
	49.3	49.8	22.7	56.8	(65.5)	.	.	49.2	Non-National/NonEU-Nationals
8.0	3.3	(1.1)	2.7	2.8	17.7	1.9	3.7	5.2	65 & + years*
8.1	3.3	.	2.7	2.8	17.7	1.9	3.6	5.2	Nationals
	Non-Nationals/EU-Nationals
	Non-National/NonEU-Nationals
62.5	52.5	61.6	70.9	68.2	67.4	67.4	70.6	70.4	15-64 years*
62.6	52.4	59.5	72.1	68.2	67.5	67.7	71.7	71.0	Nationals
63.6	65.0	66.5	70.9	75.9	58.3	62.3	71.6	64.8	Non-Nationals/EU-Nationals
44.8	67.0	52.1	33.7	66.6	63.8	46.7	38.4	52.7	Non-National/NonEU-Nationals
Males									
49.8	30.3	33.7	62.9	59.2	47.9	47.2	35.8	57.0	15-24 years*
50.0	30.1	30.3	64.1	58.6	48.1	47.3	36.3	57.8	Nationals
(50.1)		40.6	(51.8)	61.8	.	.	.	44.1	Non-Nationals/EU-Nationals
	60.2	.	(31.9)	65.4	(35.9)	.	.	31.3	Non-National/NonEU-Nationals
87.5	85.3	93.8	92.3	90.5	90.5	84.5	83.2	87.4	25-49 years*
87.9	85.2	94.0	93.8	91.2	90.5	84.8	84.4	88.0	Nationals
85.4	90.2	94.5	92.9	89.4	88.0	78.9	81.4	83.7	Non-Nationals/EU-Nationals
60.7	93.5	85.5	48.7	83.9	83.6	62.6	51.5	70.0	Non-National/NonEU-Nationals
69.5	54.1	53.7	65.1	56.7	70.6	56.7	74.6	68.4	50-64 years*
69.7	54.1	52.4	65.6	56.1	70.6	56.8	75.5	68.6	Nationals
62.0	71.2	56.4	68.8	65.8	.	.	67.8	58.4	Non-Nationals/EU-Nationals
	63.7	.	(33.8)	69.1	.	.	.	66.0	Non-National/NonEU-Nationals
14.9	5.6	.	4.8	4.2	24.3	3.8	7.0	7.7	65 & + years*
15.2	5.6	.	4.9	4.3	24.3	3.8	6.9	7.7	Nationals
	Non-Nationals/EU-Nationals
	Non-National/NonEU-Nationals
73.6	67.1	74.4	80.3	76.7	75.7	70.2	72.1	76.9	15-64 years*
73.7	67.0	73.3	81.5	76.5	75.7	70.3	73.1	77.4	Nationals
75.0	79.3	77.4	81.3	82.0	69.7	(69.6)	72.1	71.1	Non-Nationals/EU-Nationals
53.9	86.2	67.2	43.1	78.5	69.5	56.2	42.9	63.5	Non-National/NonEU-Nationals
Females									
43.0	20.8	29.5	62.5	50.7	38.5	42.8	35.0	52.8	15-24 years*
43.0	20.8	24.2	64.5	50.7	38.8	43.0	35.9	53.4	Nationals
(52.7)		37.1	(54.5)	48.4	Non-Nationals/EU-Nationals
	(32.6)	.	24.9	52.2	.	.	.	34.2	Non-National/NonEU-Nationals
62.9	51.7	62.6	72.4	74.6	74.5	77.1	79.5	73.0	25-49 years*
63.3	51.7	60.9	74.0	76.4	74.6	77.7	81.2	74.1	Nationals
57.5	58.1	68.6	67.1	78.2	62.6	.	81.5	67.1	Non-Nationals/EU-Nationals
(44.3)	50.1	39.8	27.5	57.3	71.2	42.7	42.5	46.6	Non-National/NonEU-Nationals
32.8	22.5	26.6	34.8	32.9	47.8	55.9	70.6	51.7	50-64 years*
32.8	22.5	24.5	35.2	32.5	47.7	56.1	71.6	51.9	Nationals
		31.4	(33.7)	48.3	.	.	63.4	52.2	Non-Nationals/EU-Nationals
	(31.6)	.	.	39.4	.	.	.	36.7	Non-National/NonEU-Nationals
2.7	1.7	.	1.1	2.0	13.1	(0.8)	1.2	3.4	65 & + years*
2.7	1.6	.	1.1	1.9	13.1	(0.8)	1.2	3.4	Nationals
	Non-Nationals/EU-Nationals
	Non-National/NonEU-Nationals
51.4	38.1	48.5	61.3	59.7	59.6	64.6	68.9	63.7	15-64 years*
51.5	38.0	45.2	62.4	60.0	59.6	65.0	70.2	64.5	Nationals
52.3	51.4	55.7	59.8	68.6	48.2	.	71.3	59.5	Non-Nationals/EU-Nationals
(35.6)	45.3	36.7	24.4	54.5	59.2	39.1	34.5	43.2	Non-National/NonEU-Nationals

(1) 1998.

(2) Greece 1998.

Table 14

Employment rates by age group and educational attainment level

*Rates for the Male and/or Female population in a given age group, Rates for the Male and/or Female population in a given age group and with a given educational attainment level⁽¹⁾

	EU-15 ⁽⁴⁾	EUR-11 ⁽⁵⁾	B	DK	D	EL ⁽²⁾	E	F
Males and Females								
15-24 years*	38.5	35.4	25.5	66.0	46.2	28.1	29.2	26.5
Less than upper secondary (L)	33.5	33.6	14.8	62.9	69.4	21.3	38.3	14.7
Upper secondary level (M)	48.8	43.7	31.5	70.8	67.2	33.4	20.3	36.9
Third level (H)	57.0	50.4	66.6	67.9	75.0	49.9	43.2	42.2
25-49 years*	76.4	75.5	79.2	85.3	79.1	71.8	67.1	77.8
Less than upper secondary (L)	64.3	64.9	66.0	73.4	63.7	65.7	60.5	66.9
Upper secondary level (M)	79.9	79.3	82.0	86.5	79.9	71.1	70.9	81.6
Third level (H)	87.5	86.6	91.0	90.6	89.4	85.3	79.0	85.7
50-59 years*	60.3	57.6	50.1	76.4	63.2	53.4	51.5	62.7
Less than upper secondary (L)	48.7	47.4	37.8	61.9	49.0	52.6	46.0	54.6
Upper secondary level (M)	66.7	63.8	58.2	77.9	63.1	47.3	65.7	66.9
Third level (H)	80.9	80.4	74.3	87.1	80.5	69.2	81.3	79.5
15-59 years*	65.6	63.8	62.9	79.7	69.9	58.2	54.7	64.3
Less than upper secondary (L)	53.2	53.3	46.2	66.8	61.6	51.9	52.5	50.3
Upper secondary level (M)	71.5	70.0	66.8	82.2	74.9	57.1	48.9	70.6
Third level (H)	84.0	82.8	86.7	89.4	87.0	81.3	73.4	79.2
Males								
15-24 years*	42.0	39.2	27.5	69.5	48.6	34.2	35.2	29.9
Less than upper secondary (L)	39.0	39.2	17.0	67.0	75.9	29.2	46.8	18.8
Upper secondary level (M)	52.2	47.2	36.5	74.0	67.9	39.7	24.1	41.6
Third level (H)	58.5	50.7	66.6	76.4	70.9	44.6	47.1	42.0
25-49 years*	87.0	86.8	88.0	89.9	87.1	90.2	84.7	86.7
Less than upper secondary (L)	81.7	82.6	80.3	79.1	75.6	89.4	83.0	79.0
Upper secondary level (M)	88.3	88.0	90.7	91.4	87.1	90.1	86.1	90.0
Third level (H)	92.3	92.0	94.8	93.7	93.9	91.7	87.5	90.2
50-59 years*	72.7	71.1	64.7	82.7	72.7	76.5	75.0	70.3
Less than upper secondary (L)	64.9	64.2	51.4	74.0	61.0	78.8	72.0	62.3
Upper secondary level (M)	74.8	72.9	76.3	81.9	70.8	69.8	81.0	72.9
Third level (H)	85.2	85.2	82.9	89.4	83.5	75.6	86.6	85.6
15-59 years*	75.0	74.1	71.4	84.6	77.3	74.6	70.3	71.9
Less than upper secondary (L)	67.0	67.4	57.4	72.9	72.9	71.4	72.7	58.2
Upper secondary level (M)	79.1	78.2	76.2	87.1	81.5	73.3	60.4	78.3
Third level (H)	88.7	88.2	91.0	92.2	90.9	87.6	81.7	84.2
Females								
15-24 years*	35.0	31.8	23.4	62.8	43.9	22.2	23.1	23.3
Less than upper secondary (L)	27.3	27.3	12.1	58.2	62.2	11.9	27.9	10.3
Upper secondary level (M)	45.6	40.4	26.8	68.5	66.5	28.1	16.9	32.3
Third level (H)	56.0	50.3	66.6	66.6	77.1	51.9	40.4	42.3
25-49 years*	65.8	64.2	70.1	80.5	70.8	54.2	50.0	69.1
Less than upper secondary (L)	48.3	48.1	49.3	68.0	54.8	43.3	38.5	56.3
Upper secondary level (M)	71.1	70.2	73.4	80.7	72.6	53.3	55.9	72.3
Third level (H)	82.4	80.9	87.5	87.9	83.0	78.5	70.9	81.6
50-59 years*	48.2	44.3	35.5	70.1	53.6	32.1	29.2	55.2
Less than upper secondary (L)	36.0	34.0	25.8	55.2	42.6	31.7	24.2	48.6
Upper secondary level (M)	57.4	53.6	38.7	73.2	55.4	25.1	45.8	59.2
Third level (H)	74.3	72.4	63.4	84.1	74.1	55.8	71.4	72.7
15-59 years*	56.1	53.6	54.1	74.8	62.3	42.4	39.4	57.0
Less than upper secondary (L)	40.5	39.9	33.9	61.3	52.9	33.4	32.7	43.2
Upper secondary level (M)	63.7	61.7	57.5	76.9	68.3	42.5	37.9	62.1
Third level (H)	78.7	76.7	82.6	86.7	81.2	74.3	65.3	74.7

⁽¹⁾ Non responses to the variable HIGHER LEVEL OF EDUCATION ATTAINED not considered.

⁽²⁾ 1998.

⁽³⁾ 1997.

⁽⁴⁾ Greece 1998, Ireland 1997.

⁽⁵⁾ Ireland 1997.

Table 14

Employment rates by age group and educational attainment level

*Rates for the Male and/or Female population in a given age group, Rates for the Male and/or Female population in a given age group and with a given educational attainment level⁽¹⁾

IRL ⁽³⁾	I	L	NL	A	P	FIN	S	UK	
Males and Females									
38.3	25.5	31.7	62.7	54.9	43.3	45.0	35.4	55.0	15-24 years*
20.9	21.2	30.0	55.9	38.4	44.8	29.2	24.3	32.9	Less than upper secondary (L)
49.1	31.4	33.6	74.5	70.8	35.5	59.7	56.5	65.3	Upper secondary level (M)
74.3	52.4	(22.2)	92.8	67.1	75.3	75.5	44.1	80.5	Third level (H)
69.3	68.6	78.4	82.5	82.6	82.3	80.9	81.4	80.3	25-49 years*
56.4	61.9	69.8	69.6	69.2	82.3	72.6	69.7	54.8	Less than upper secondary (L)
73.1	73.8	81.6	86.2	85.2	84.1	79.4	82.7	82.4	Upper secondary level (M)
87.1	83.5	87.2	92.1	91.7	93.9	88.4	86.6	91.0	Third level (H)
52.2	47.1	51.7	61.4	56.0	65.6	69.0	81.4	69.7	50-59 years*
45.6	40.7	37.0	47.9	42.6	66.9	60.9	72.8	52.3	Less than upper secondary (L)
56.0	62.0	55.6	67.2	59.9	74.2	68.9	81.9	75.7	Upper secondary level (M)
77.4	79.2	85.6	82.1	87.2	86.9	84.3	92.0	80.8	Third level (H)
57.8	55.8	65.2	74.6	72.2	69.5	71.1	72.4	73.2	15-59 years*
43.9	48.0	54.8	60.8	53.0	69.9	54.7	56.8	50.6	Less than upper secondary (L)
63.2	63.1	68.2	81.0	78.4	64.1	73.5	78.4	77.3	Upper secondary level (M)
83.7	82.1	80.8	90.2	90.4	91.2	87.1	84.5	88.2	Third level (H)
Males									
40.9	30.3	33.7	62.9	59.2	47.9	47.2	35.8	57.0	15-24 years*
26.2	26.4	32.6	58.8	45.4	50.4	31.7	23.6	38.3	Less than upper secondary (L)
51.4	36.3	37.8	73.9	73.2	38.1	63.6	57.3	67.1	Upper secondary level (M)
75.1	59.4	.	89.7	.	75.3	74.1	46.1	80.1	Third level (H)
83.1	85.3	93.8	92.3	90.5	90.5	84.5	83.2	87.4	25-49 years*
74.0	85.4	91.3	85.9	80.6	92.0	77.8	74.9	64.5	Less than upper secondary (L)
90.0	85.0	96.1	94.8	91.6	88.7	82.9	84.9	89.5	Upper secondary level (M)
93.4	89.8	92.8	95.8	96.0	95.2	93.5	86.3	94.1	Third level (H)
71.7	65.2	69.9	78.5	71.2	78.8	67.8	82.6	76.8	50-59 years*
66.2	59.7	56.2	70.0	60.0	78.6	59.8	77.9	60.6	Less than upper secondary (L)
81.1	74.5	70.6	79.8	72.1	80.9	67.2	82.3	80.7	Upper secondary level (M)
87.5	88.4	94.2	88.2	92.6	94.0	83.5	90.9	84.7	Third level (H)
69.1	70.5	78.7	84.0	81.0	77.5	73.6	73.8	79.3	15-59 years*
58.6	66.4	71.4	74.6	62.3	78.5	57.8	60.9	58.1	Less than upper secondary (L)
74.7	73.7	80.9	88.5	85.4	69.5	76.8	79.8	82.8	Upper secondary level (M)
89.6	89.1	86.4	94.0	94.4	93.8	90.5	84.6	91.1	Third level (H)
Females									
35.6	20.8	29.5	62.5	50.7	38.5	42.8	35.0	52.8	15-24 years*
14.8	15.3	27.2	52.5	31.4	38.5	26.6	25.0	26.8	Less than upper secondary (L)
46.9	27.3	29.7	74.9	68.6	33.5	55.8	55.7	63.4	Upper secondary level (M)
73.7	48.5	(31.8)	94.4	79.3	75.4	76.2	42.7	80.9	Third level (H)
55.6	51.7	62.6	72.4	74.6	74.5	77.1	79.5	73.0	25-49 years*
35.6	37.3	51.2	54.3	62.8	72.6	65.7	63.1	48.4	Less than upper secondary (L)
60.4	62.8	66.3	77.5	77.5	79.7	75.1	80.4	74.9	Upper secondary level (M)
80.8	77.4	79.8	87.7	87.3	93.0	84.5	86.8	87.6	Third level (H)
32.0	29.7	33.7	43.9	41.4	53.8	70.1	80.1	62.8	50-59 years*
22.4	23.6	25.3	33.7	33.6	53.9	62.1	66.7	47.4	Less than upper secondary (L)
38.0	46.2	36.3	49.7	44.9	62.6	70.4	81.5	69.7	Upper secondary level (M)
65.9	66.6	69.1	71.3	76.3	80.2	85.1	93.1	75.9	Third level (H)
46.4	41.1	51.5	65.0	63.4	61.8	68.5	71.0	67.0	15-59 years*
26.8	29.2	40.7	48.3	46.8	60.9	51.1	52.1	45.4	Less than upper secondary (L)
53.8	52.8	54.6	73.0	70.1	59.2	69.9	76.9	71.4	Upper secondary level (M)
77.9	74.9	73.1	85.6	85.7	89.4	84.3	84.4	84.9	Third level (H)

⁽¹⁾ Non responses to the variable HIGHER LEVEL OF EDUCATION ATTAINED not considered.

⁽²⁾ 1998.

⁽³⁾ 1997.

⁽⁴⁾ Greece 1998, Ireland 1997.

⁽⁵⁾ Ireland 1997.

EMPLOYMENT

All in employment

Table 15

Employment by age group and nationality

Thousands

	EU-15 ⁽²⁾	EUR-11	B	DK	D	EL ⁽¹⁾	E	F
Males and Females								
15-24 years	17 729	12 798	318	401	4 058	399	1 757	1 921
Nationals	16 908	12 127	299	391	3 631	374	1 739	1 841
Non-Nationals/EU-Nationals	226	173	12	.	98	.	(4)	27
Non-National/NonEU-Nationals	594	498	7	9	329	25	14	54
Non responses	1	0	0	0	0	0	0	0
25-49 years	103 708	80 071	2 986	1 652	23 888	2 563	9 071	16 454
Nationals	98 778	76 113	2 746	1 612	21 913	2 455	8 937	15 591
Non-Nationals/EU-Nationals	1 858	1 502	182	17	659	5	37	369
Non-National/NonEU-Nationals	3 071	2 456	58	23	1 316	103	96	494
Non responses	1	0	0	0	0	0	0	0
50-64 years	31 875	23 253	651	639	7 797	893	2 830	4 285
Nationals	30 692	22 294	606	626	7 297	882	2 807	4 008
Non-Nationals/EU-Nationals	593	456	39	6	215	.	14	134
Non-National/NonEU-Nationals	589	503	6	7	285	10	8	144
Non responses	0	0	0	0	0	0	0	0
All in Employment	155 272	117 436	3 987	2 708	36 089	3 967	13 773	22 755
Nationals	148 297	111 824	3 682	2 645	33 175	3 822	13 598	21 529
Non-Nationals/EU-Nationals	2 700	2 141	233	24	977	7	56	531
Non-National/NonEU-Nationals	4 273	3 470	72	39	1 937	138	119	694
Non responses	2	1	0	0	0	0	0	0
Males								
15-24 years	9 682	7 052	174	205	2 129	239	1 063	1 066
Nationals	9 243	6 683	163	200	1 897	222	1 054	1 017
Non-Nationals/EU-Nationals	116	95	8	.	52	.	.	16
Non-National/NonEU-Nationals	323	274	(4)	5	181	17	7	34
Non responses	0	0	0	0	0	0	0	0
25-49 years	59 232	46 159	1 681	887	13 372	1 577	5 641	9 086
Nationals	56 190	43 659	1 520	866	12 101	1 510	5 564	8 547
Non-Nationals/EU-Nationals	1 096	913	119	8	408	.	22	219
Non-National/NonEU-Nationals	1 945	1 587	43	13	863	64	54	319
Non responses	1	0	0	0	0	0	0	0
50-64 years	19 366	14 454	427	359	4 651	610	2 001	2 364
Nationals	18 578	13 780	393	353	4 305	603	1 986	2 167
Non-Nationals/EU-Nationals	370	305	29	.	149	.	10	78
Non-National/NonEU-Nationals	419	369	5	(3)	197	7	(4)	120
Non responses	0	0	0	0	0	0	0	0
All in Employment	89 556	68 519	2 306	1 460	20 372	2 504	8 779	12 577
Nationals	85 256	64 958	2 097	1 428	18 512	2 413	8 678	11 789
Non-Nationals/EU-Nationals	1 599	1 321	157	10	613	(3)	35	314
Non-National/NonEU-Nationals	2 700	2 239	52	22	1 247	87	66	475
Non responses	1	1	0	0	0	0	0	0
Females								
15-24 years	8 046	5 746	143	196	1 929	160	694	855
Nationals	7 665	5 444	136	191	1 735	152	685	824
Non-Nationals/EU-Nationals	110	78	(4)	.	46	.	.	11
Non-National/NonEU-Nationals	270	224	(3)	(4)	148	8	7	20
Non responses	0	0	0	0	0	0	0	(0)
25-49 years	44 476	33 912	1 305	766	10 516	986	3 430	7 368
Nationals	42 588	32 454	1 226	746	9 812	944	3 373	7 044
Non-Nationals/EU-Nationals	762	589	64	9	251	(3)	16	150
Non-National/NonEU-Nationals	1 126	869	15	10	453	39	42	174
Non responses	0	0	0	0	0	0	0	(0)
50-64 years	12 509	8 799	224	280	3 145	283	828	1 921
Nationals	12 114	8 514	213	273	2 992	280	821	1 841
Non-Nationals/EU-Nationals	224	151	9	(4)	66	.	(3)	56
Non-National/NonEU-Nationals	171	134	.	(3)	88	(3)	(4)	24
Non responses	0	0	0	0	0	0	0	(0)
All in Employment	65 716	48 917	1 682	1 248	15 717	1 463	4 994	10 177
Nationals	63 041	46 866	1 585	1 216	14 663	1 409	4 920	9 740
Non-Nationals/EU-Nationals	1 101	820	77	14	364	(3)	21	218
Non-National/NonEU-Nationals	1 573	1 231	20	17	690	51	53	219
Non responses	1	0	0	0	0	0	0	(0)

(1) 1998.

(2) Greece 1998.

Table 15

Employment by age group and nationality

Thousands

IRL	I	L	NL	A	P	FIN	S	UK	
Males and Females									
306	1 777	15	1 173	503	682	287	362	3 769	15-24 years
299	1 758	7	1 142	451	674	285	354	3 663	Nationals
6	.	7	11	4	.	.	.	49	Non-Nationals/EU-Nationals
.	17	(1)	20	48	5	.	.	57	Non-National/NonEU-Nationals
0	0	0	0	0	0	0	0	0	Non responses
982	14 550	134	5 052	2 537	2 922	1 496	2 463	16 959	25-49 years
944	14 379	78	4 880	2 289	2 880	1 477	2 356	16 243	Nationals
30	20	50	97	41	11	(4)	49	284	Non-Nationals/EU-Nationals
7	151	5	75	207	31	15	58	431	Non-National/NonEU-Nationals
0	0	0	0	0	0	0	0	1	Non responses
271	3 965	26	1 327	605	962	535	1 173	5 917	50-64 years
263	3 946	18	1 291	569	956	533	1 142	5 748	Nationals
7	(5)	8	26	7	.	.	22	108	Non-Nationals/EU-Nationals
.	14	(1)	10	28	(4)	.	.	61	Non-National/NonEU-Nationals
0	0	0	0	0	0	0	0	0	Non responses
1 593	20 618	176	7 605	3 678	4 830	2 333	4 054	27 107	All in Employment
1 539	20 407	104	7 365	3 342	4 773	2 310	3 905	26 101	Nationals
44	28	66	133	52	16	5	77	451	Non-Nationals/EU-Nationals
9	183	7	106	284	41	18	72	554	Non-National/NonEU-Nationals
0	0	0	0	0	0	0	0	1	Non responses
Males									
167	1 049	8	598	268	380	150	187	1 999	15-24 years
164	1 038	4	582	241	375	149	182	1 955	Nationals
(3)	.	4	(5)	3	.	.	.	20	Non-Nationals/EU-Nationals
.	10	.	(10)	25	(3)	.	.	24	Non-National/NonEU-Nationals
0	0	0	0	0	0	0	0	0	Non responses
569	9 085	81	2 867	1 399	1 579	800	1 284	9 326	25-49 years
546	8 970	48	2 764	1 252	1 558	788	1 234	8 921	Nationals
18	11	29	53	24	6	(3)	21	152	Non-Nationals/EU-Nationals
5	104	4	49	122	15	8	29	252	Non-National/NonEU-Nationals
0	0	0	0	0	0	0	0	0	Non responses
185	2 756	17	870	377	542	263	606	3 338	50-64 years
180	2 742	12	841	352	539	262	589	3 254	Nationals
5	(4)	5	20	4	.	.	12	49	Non-Nationals/EU-Nationals
.	10	.	(8)	20	.	.	.	35	Non-National/NonEU-Nationals
0	0	0	0	0	0	0	0	0	Non responses
948	13 119	107	4 374	2 063	2 651	1 223	2 123	14 950	All in Employment
916	12 978	65	4 227	1 864	2 622	1 210	2 049	14 407	Nationals
26	16	38	79	31	9	(4)	37	228	Non-Nationals/EU-Nationals
6	125	5	68	168	20	10	37	314	Non-National/NonEU-Nationals
0	0	0	0	0	0	0	0	0	Non responses
Females									
139	728	7	576	234	302	138	175	1 770	15-24 years
135	720	3	559	210	299	137	171	1 707	Nationals
(4)	.	4	(6)	29	Non-Nationals/EU-Nationals
.	(7)	.	11	23	.	.	.	33	Non-National/NonEU-Nationals
0	0	0	0	0	0	0	0	0	Non responses
413	5 464	53	2 185	1 138	1 343	697	1 179	7 634	25-49 years
399	5 409	30	2 116	1 036	1 322	689	1 122	7 322	Nationals
12	9	21	43	18	5	.	28	133	Non-Nationals/EU-Nationals
(3)	47	2	26	84	16	7	29	179	Non-National/NonEU-Nationals
0	0	0	0	0	0	0	0	0	Non responses
86	1 209	9	457	228	419	272	567	2 579	50-64 years
83	1 204	6	450	217	416	271	553	2 494	Nationals
.	.	3	(5)	3	.	.	10	59	Non-Nationals/EU-Nationals
.	(4)	.	.	8	.	.	.	26	Non-National/NonEU-Nationals
0	0	0	0	0	0	0	0	0	Non responses
645	7 499	69	3 231	1 615	2 179	1 109	1 931	12 157	All in Employment
623	7 429	39	3 138	1 477	2 151	1 100	1 856	11 694	Nationals
18	11	28	54	21	7	.	41	223	Non-Nationals/EU-Nationals
(4)	58	2	38	116	21	8	34	240	Non-National/NonEU-Nationals
0	0	0	0	0	0	0	0	1	Non responses

(1) 1998.

(2) Greece 1998.

Table 16

Employment by professional status

Thousands

	EU-15 ⁽²⁾	EUR-11	B	DK	D	EL ⁽¹⁾	E	F
	Males and Females							
Employers and self-employed	22 434	17 303	590	224	3 594	1 288	2 650	2 423
Employees	130 016	97 893	3 299	2 457	32 193	2 245	10 771	19 989
Family workers	2 756	2 175	98	28	303	434	335	343
Non responses	67	66	0	0	0	0	17	0
All in employment	155 272	117 436	3 987	2 708	36 089	3 967	13 773	22 755
	Males							
Employers and self-employed	16 365	12 509	410	173	2 610	995	1 951	1 800
Employees	72 263	55 254	1 886	1 284	17 698	1 383	6 690	10 718
Family workers	892	721	10	(3)	64	126	127	59
Non responses	35	34	0	0	0	0	11	0
All in employment	89 556	68 519	2 306	1 460	20 372	2 504	8 779	12 577
	Females							
Employers and self-employed	6 069	4 794	181	51	984	293	699	623
Employees	57 752	42 638	1 412	1 173	14 494	862	4 082	9 270
Family workers	1 863	1 454	89	24	239	308	208	284
Non responses	32	32	0	0	0	0	6	0
All in employment	65 716	48 917	1 682	1 248	15 717	1 463	4 994	10 177
	<i>Percentages of the Male and/or Female population in employment (Non responses not considered)</i>							
	EU-15 ⁽²⁾	EUR-11	B	DK	D	EL ⁽¹⁾	E	F
	Males and Females							
Employers and self-employed	14.5	14.7	14.8	8.3	10.0	32.5	19.3	10.6
Employees	83.8	83.4	82.7	90.7	89.2	56.6	78.3	87.8
Family workers	1.8	1.9	2.5	1.0	0.8	10.9	2.4	1.5
	Males							
Employers and self-employed	18.3	18.3	17.8	11.9	12.8	39.7	22.3	14.3
Employees	80.7	80.7	81.8	87.9	86.9	55.2	76.3	85.2
Family workers	1.0	1.1	0.4	(0.2)	0.3	5.0	1.5	0.5
	Females							
Employers and self-employed	9.2	9.8	10.7	4.1	6.3	20.1	14.0	6.1
Employees	87.9	87.2	84.0	94.0	92.2	58.9	81.8	91.1
Family workers	2.8	3.0	5.3	1.9	1.5	21.0	4.2	2.8

⁽¹⁾ 1998.⁽²⁾ Greece 1998.

Table 16

Employment by professional status

Thousands

IRL	I	L	NL	A	P	FIN	S	UK	
Males and Females									
283	5 040	15	812	400	1 193	302	444	3 176	Employers and self-employed
1 284	14 782	160	6 730	3 175	3 499	2 011	3 589	23 832	Employees
19	796	(1)	62	103	95	19	21	99	Family workers
6	0	0	1	0	42	0	0	0	Non responses
1 593	20 618	176	7 605	3 678	4 830	2 333	4 054	27 107	All in employment
Males									
236	3 785	10	550	258	695	205	333	2 355	Employers and self-employed
701	8 971	97	3 814	1 771	1 900	1 008	1 782	12 561	Employees
9	363	.	(8)	33	36	10	.	34	Family workers
3	0	0	1	0	20	0	0	0	Non responses
948	13 119	107	4 374	2 063	2 651	1 223	2 123	14 950	All in employment
Females									
47	1 255	5	262	142	498	98	111	820	Employers and self-employed
584	5 811	63	2 916	1 404	1 600	1 003	1 807	11 272	Employees
11	433	(1)	53	70	59	8	13	65	Family workers
3	0	0	0	0	23	0	0	0	Non responses
645	7 499	69	3 231	1 615	2 179	1 109	1 931	12 157	All in employment

Percentages of the Male and/or Female population in employment (Non responses not considered)

IRL	I	L	NL	A	P	FIN	S	UK	
Males and Females									
17.8	24.4	8.4	10.7	10.9	24.9	13.0	10.9	11.7	Employers and self-employed
80.9	71.7	90.9	88.5	86.3	73.1	86.2	88.5	87.9	Employees
1.2	3.9	(0.7)	0.8	2.8	2.0	0.8	0.5	0.4	Family workers
Males									
25.0	28.8	9.3	12.6	12.5	26.4	16.7	15.7	15.8	Employers and self-employed
74.1	68.4	90.5	87.2	85.9	72.2	82.4	83.9	84.0	Employees
0.9	2.8	.	(0.2)	1.6	1.4	0.9	.	0.2	Family workers
Females									
7.3	16.7	7.0	8.1	8.8	23.1	8.8	5.7	6.7	Employers and self-employed
91.0	77.5	91.5	90.2	86.9	74.2	90.4	93.6	92.7	Employees
1.7	5.8	(1.5)	1.6	4.3	2.7	0.8	0.7	0.5	Family workers

⁽¹⁾ 1998.

⁽²⁾ Greece 1998.

Table 17

Employment by economic activity

Thousands

	EU-15 ⁽²⁾	EUR-11	B	DK	D	EL ⁽¹⁾	E	F
Males and Females								
Agriculture (A-B)	6 930	5 594	95	90	1 034	704	1 020	968
Industry (C-F)	45 372	35 661	1 028	726	12 210	914	4 215	5 991
Mining and quarrying (C)	545	412	11	(4)	174	18	65	47
Manufacturing (D)	31 551	24 849	739	512	8 574	578	2 621	4 291
Electricity, gaz, water supply (E)	1 203	935	29	19	314	35	91	188
Construction (F)	12 073	9 464	249	192	3 148	282	1 438	1 464
Services (G-Q)	102 513	75 762	2 864	1 882	22 845	2 349	8 538	15 789
Wholesale and retail, repairs (G)	23 025	17 244	584	379	5 151	668	2 255	3 036
Hotels and restaurants (H)	6 125	4 550	127	65	1 163	249	855	762
Transports, communications (I)	9 280	6 795	312	177	1 973	245	795	1 465
Financial intermediation (J)	5 257	3 833	163	86	1 300	96	365	722
Real estate, business activit. (K)	12 915	9 092	288	240	2 736	194	923	2 094
Public administration (L)	11 651	9 398	366	156	2 996	279	884	2 070
Other services (M-Q)	34 259	24 850	1 024	780	7 527	618	2 461	5 641
Non responses	457	420	0	10	0	0	0	7
All in employment	155 272	117 436	3 987	2 708	36 089	3 967	13 773	22 755
Males								
Agriculture (A-B)	4 620	3 721	62	72	664	407	755	662
Industry (C-F)	35 119	27 529	835	535	9 300	734	3 538	4 523
Mining and quarrying (C)	485	370	10	(3)	163	17	57	40
Manufacturing (D)	22 622	17 741	575	346	6 143	407	2 019	3 015
Electricity, gaz, water supply (E)	970	768	25	16	248	29	80	144
Construction (F)	11 041	8 650	225	170	2 745	280	1 381	1 324
Services (G-Q)	49 605	37 080	1 408	849	10 408	1 363	4 486	7 388
Wholesale and retail, repairs (G)	12 377	9 324	305	219	2 423	413	1 267	1 705
Hotels and restaurants (H)	2 854	2 186	60	22	487	146	460	404
Transports, communications (I)	6 981	5 095	246	128	1 403	212	647	1 053
Financial intermediation (J)	2 749	2 063	96	47	636	51	241	330
Real estate, business activit. (K)	7 174	4 931	161	139	1 413	109	496	1 128
Public administration (L)	6 814	5 548	206	85	1 690	185	549	1 093
Other services (M-Q)	10 657	7 933	335	210	2 355	247	826	1 675
Non responses	212	188	0	5	0	0	0	5
All in employment	89 556	68 519	2 306	1 460	20 372	2 504	8 779	12 577
Females								
Agriculture (A-B)	2 310	1 873	34	18	370	297	265	306
Industry (C-F)	10 253	8 131	192	192	2 910	180	677	1 468
Mining and quarrying (C)	60	42	.	.	10	.	7	(7)
Manufacturing (D)	8 928	7 108	164	166	2 430	171	602	1 276
Electricity, gaz, water supply (E)	233	167	(4)	.	66	6	11	45
Construction (F)	1 032	814	23	22	403	.	57	140
Services (G-Q)	52 908	38 682	1 456	1 033	12 437	986	4 052	8 401
Wholesale and retail, repairs (G)	10 648	7 920	279	160	2 728	255	988	1 331
Hotels and restaurants (H)	3 271	2 364	67	43	676	103	395	358
Transports, communications (I)	2 300	1 700	66	49	570	33	148	412
Financial intermediation (J)	2 508	1 770	68	39	663	45	124	392
Real estate, business activit. (K)	5 741	4 161	127	101	1 322	85	427	966
Public administration (L)	4 837	3 850	160	71	1 306	93	335	977
Other services (M-Q)	23 602	16 917	689	570	5 172	372	1 635	3 966
Non responses	245	231	0	5	0	0	0	2
All in employment	65 716	48 917	1 682	1 248	15 717	1 463	4 994	10 177

⁽¹⁾ 1998.⁽²⁾ Greece 1998.

Table 17

Employment by economic activity

Thousands

IRL	I	L	NL	A	P	FIN	S	UK	
Males and Females									
136	1 118	3	231	229	611	148	121	421	Agriculture (A-B)
451	6 675	39	1 610	1 094	1 704	645	1 013	7 058	Industry (C-F)
6	70	.	11	10	14	5	.	101	Mining and quarrying (C)
291	4 869	21	1 099	753	1 121	470	754	4 858	Manufacturing (D)
12	171	(1)	39	33	36	21	29	185	Electricity, gaz,water supply (E)
142	1 566	16	462	298	533	149	222	1 914	Construction (F)
996	12 825	133	5 368	2 354	2 516	1 532	2 917	19 603	Services (G-Q)
223	3 263	23	1 138	597	686	289	518	4 215	Wholesale and retail,repairs (G)
103	742	6	253	209	252	78	110	1 151	Hotels and restaurants (H)
96	1 119	13	442	249	162	170	268	1 795	Transports, communications (I)
61	657	18	274	144	84	46	85	1 156	Financial intermediation (J)
135	1 369	13	866	241	210	217	433	2 957	Real estate,business activit. (K)
74	1 813	16	541	221	298	118	201	1 617	Public administration (L)
303	3 862	44	1 855	695	823	614	1 301	6 711	Other services (M-Q)
10	0	0	395	0	0	7	3	25	Non responses
1 593	20 618	176	7 605	3 678	4 830	2 333	4 054	27 107	All in employment
Males									
120	779	2	163	117	296	100	92	329	Agriculture (A-B)
352	5 096	34	1 320	867	1 178	488	791	5 530	Industry (C-F)
5	60	.	(8)	8	13	(4)	.	88	Mining and quarrying (C)
200	3 418	18	851	556	617	328	561	3 567	Manufacturing (D)
10	150	(1)	32	29	33	17	22	134	Electricity, gaz,water supply (E)
136	1 468	15	429	274	514	139	200	1 741	Construction (F)
471	7 244	71	2 716	1 079	1 177	632	1 239	9 074	Services (G-Q)
118	2 038	12	631	270	404	151	291	2 130	Wholesale and retail,repairs (G)
42	402	3	122	76	105	25	47	454	Hotels and restaurants (H)
72	901	10	324	192	125	122	198	1 348	Transports, communications (I)
26	426	11	154	71	57	14	37	550	Financial intermediation (J)
73	795	8	522	112	103	120	268	1 727	Real estate,business activit. (K)
45	1 198	11	372	135	193	57	105	891	Public administration (L)
95	1 484	15	592	223	189	142	294	1 974	Other services (M-Q)
5	0	0	175	0	0	4	2	17	Non responses
948	13 119	107	4 374	2 063	2 651	1 223	2 123	14 950	All in employment
Females									
16	339	(1)	68	112	314	49	29	92	Agriculture (A-B)
99	1 579	5	290	227	526	157	222	1 528	Industry (C-F)
.	10	14	Mining and quarrying (C)
91	1 451	3	247	197	503	142	193	1 290	Manufacturing (D)
.	21	.	(7)	4	(3)	(4)	.	51	Electricity, gaz,water supply (E)
6	98	(1)	33	24	18	10	22	173	Construction (F)
525	5 581	63	2 652	1 275	1 339	900	1 678	10 529	Services (G-Q)
105	1 225	10	506	327	282	138	227	2 086	Wholesale and retail,repairs (G)
61	340	3	132	133	147	53	63	698	Hotels and restaurants (H)
24	218	3	118	56	37	48	71	447	Transports, communications (I)
35	230	7	120	72	27	32	48	606	Financial intermediation (J)
62	574	5	344	129	107	98	165	1 229	Real estate,business activit. (K)
29	615	5	170	86	106	61	97	727	Public administration (L)
209	2 378	28	1 263	472	634	471	1 007	4 737	Other services (M-Q)
5	0	0	220	0	0	3	1	8	Non responses
645	7 499	69	3 231	1 615	2 179	1 109	1 931	12 157	All in employment

(1) 1998.

(2) Greece 1998.

Table 18

Employment by occupation

Thousands

	EU-15 ⁽³⁾	EUR-11 ⁽⁴⁾	B	DK	D	EL ⁽¹⁾	E	F
Males and Females								
Legislators and managers (1)	12 806	7 934	445	199	2 083	441	1 126	1 708
Professionals (2)	20 096	14 267	784	355	4 653	488	1 588	2 424
Technicians (3)	22 335	18 367	444	510	7 146	278	1 227	3 954
Clerks (4)	20 322	14 715	613	335	4 600	378	1 331	3 177
Services and sales workers (5)	20 737	15 060	417	414	4 127	478	1 915	2 876
Agriculture/ fishery workers (6)	5 538	4 413	93	64	781	684	711	1 000
Craft/related trades workers (7)	23 743	19 144	450	301	6 449	626	2 352	3 073
Plant and machine operators (8)	13 506	10 384	356	201	2 687	316	1 458	2 414
Elementary occupations (9)	13 430	10 608	342	308	2 883	234	1 999	1 805
Armed forces (0)	1 106	907	38	17	218	44	66	280
Non responses	1 434	1 417	6	4	464	0	0	44
All in employment	155 052	117 216	3 987	2 708	36 089	3 967	13 773	22 755
Males								
Legislators and managers (1)	8 989	5 692	304	156	1 535	331	774	1 133
Professionals (2)	11 180	7 999	365	221	2 941	261	809	1 502
Technicians (3)	11 274	9 222	296	219	3 002	152	766	1 952
Clerks (4)	6 558	4 964	231	97	1 451	166	546	755
Services and sales workers (5)	6 862	5 185	123	89	1 015	228	813	754
Agriculture/ fishery workers (6)	3 771	3 003	63	54	528	393	540	716
Craft/related trades workers (7)	21 260	17 031	414	286	5 828	548	2 169	2 837
Plant and machine operators (8)	11 153	8 536	299	151	2 268	275	1 236	1 921
Elementary occupations (9)	6 535	5 105	172	169	1 324	112	1 061	714
Armed forces (0)	1 053	871	35	15	214	38	65	258
Non responses	811	801	4	3	267	0	0	37
All in employment	89 446	68 409	2 306	1 460	20 372	2 504	8 779	12 577
Females								
Legislators and managers (1)	3 817	2 242	141	44	548	111	352	575
Professionals (2)	8 916	6 269	419	134	1 712	226	772	922
Technicians (3)	11 061	9 145	148	291	4 144	126	461	2 002
Clerks (4)	13 765	9 751	382	238	3 149	212	785	2 422
Services and sales workers (5)	13 875	9 876	294	325	3 112	249	1 102	2 122
Agriculture/ fishery workers (6)	1 767	1 410	29	9	253	291	171	284
Craft/related trades workers (7)	2 483	2 113	36	15	620	78	183	236
Plant and machine operators (8)	2 353	1 848	56	50	419	41	222	493
Elementary occupations (9)	6 895	5 503	170	139	1 558	122	938	1 091
Armed forces (0)		37	(4)			6		22
Non responses	622	615	2	1	197	0	0	7
All in employment	65 606	48 807	1 682	1 248	15 717	1 463	4 994	10 177

⁽¹⁾ 1998.⁽²⁾ 1997.⁽³⁾ Greece 1998, Ireland 1997.⁽⁴⁾ Ireland 1997.

Table 18

Employment by occupation

Thousands

IRL ⁽²⁾	I	L	NL	A	P	FIN	S	UK	
Males and Females									
122	680	11	891	293	346	231	200	4 031	Legislators and managers (1)
235	2 103	28	1 347	360	323	423	636	4 350	Professionals (2)
52	2 989	33	1 315	501	341	366	814	2 366	Technicians (3)
187	2 711	28	907	520	440	201	425	4 471	Clerks (4)
237	3 108	16	916	500	664	284	746	4 039	Services and sales workers (5)
111	698	5	118	212	544	141	112	265	Agriculture/ fishery workers (6)
182	3 786	24	791	628	1 113	295	455	3 218	Craft/related trades workers (7)
122	1 932	13	494	320	396	192	439	2 166	Plant and machine operators (8)
123	1 710	18	580	344	626	179	211	2 069	Elementary occupations (9)
.	212	.	45	.	36	11	13	125	Armed forces (0)
3	690	0	200	0	0	9	4	9	Non responses
1 373	20 618	176	7 605	3 678	4 830	2 333	4 054	27 107	All in employment
Males									
86	557	8	681	211	239	166	144	2 666	Legislators and managers (1)
118	966	17	765	185	150	181	312	2 386	Professionals (2)
36	1 894	18	641	268	184	167	430	1 250	Technicians (3)
54	1 231	13	299	174	171	40	120	1 211	Clerks (4)
95	1 616	6	290	160	244	69	154	1 206	Services and sales workers (5)
103	505	3	81	107	265	91	85	236	Agriculture/ fishery workers (6)
147	3 229	23	735	567	818	263	427	2 968	Craft/related trades workers (7)
107	1 537	12	429	266	306	155	363	1 827	Plant and machine operators (8)
91	996	6	300	125	241	75	71	1 078	Elementary occupations (9)
.	212	.	41	.	34	11	13	117	Armed forces (0)
2	376	0	110	0	0	6	3	4	Non responses
838	13 119	107	4 374	2 063	2 651	1 223	2 123	14 950	All in employment
Females									
37	123	3	210	82	107	65	56	1 365	Legislators and managers (1)
117	1 137	11	581	175	174	242	324	1 963	Professionals (2)
16	1 095	14	674	233	157	200	384	1 116	Technicians (3)
133	1 480	15	608	346	269	161	304	3 260	Clerks (4)
143	1 492	10	625	340	420	215	592	2 833	Services and sales workers (5)
8	193	(1)	37	104	279	50	28	28	Agriculture/ fishery workers (6)
35	557	(1)	55	61	295	33	27	250	Craft/related trades workers (7)
15	395	(1)	65	54	90	37	76	339	Plant and machine operators (8)
32	714	12	280	219	385	104	140	991	Elementary occupations (9)
.	Armed forces (0)
1	313	0	90	0	0	4	1	5	Non responses
535	7 499	69	3 231	1 615	2 179	1 109	1 931	12 157	All in employment

⁽¹⁾ 1998.

⁽²⁾ 1997.

⁽³⁾ Greece 1998, Ireland 1997.

⁽⁴⁾ Ireland 1997.

Table 19

Employment by place of work (work from home)

Thousands

	EU-15 ⁽³⁾	EUR-11 ⁽⁴⁾	B	DK	D	EL ⁽¹⁾	E	F
Males and Females								
Usually work from home	6 391	5 053	247	289	1 478	68	114	1 010
Sometimes work from home	11 352	5 032	321	148	2 789	141	170	566
Never work from home	135 231	106 924	3 420	2 268	31 653	3 758	13 489	21 176
Non responses	2 078	207	0	2	170	0	0	2
All in employment	155 052	117 216	3 987	2 708	36 089	3 967	13 773	22 755
Males								
Usually work from home	3 352	2 769	134	161	793	31	39	556
Sometimes work from home	7 335	3 379	213	103	1 855	75	111	418
Never work from home	77 548	62 151	1 958	1 195	17 635	2 399	8 628	11 602
Non responses	1 211	108	0	1	88	0	0	1
All in employment	89 446	68 409	2 306	1 460	20 372	2 504	8 779	12 577
Females								
Usually work from home	3 039	2 283	112	128	684	38	75	454
Sometimes work from home	4 017	1 653	108	45	933	66	59	148
Never work from home	57 683	44 773	1 462	1 074	14 018	1 359	4 861	9 573
Non responses	867	99	0	1	82	0	0	1
All in employment	65 606	48 807	1 682	1 248	15 717	1 463	4 994	10 177

⁽¹⁾ 1998.⁽²⁾ 1997.⁽³⁾ Greece 1998, Ireland 1997.⁽⁴⁾ Ireland 1997.

Table 19

Employment by place of work (work from home)

Thousands

IRL ⁽²⁾	I	L	NL	A	P	FIN	S	UK	
Males and Females									
100	826	16	471	424	125	241	338	643	Usually work from home
75	530	15	.	226	205	136	181	5 850	Sometimes work from home
1 192	19 241	146	7 132	3 027	4 500	1 948	3 286	18 995	Never work from home
6	20	0	1	0	0	8	249	1 619	Non responses
1 373	20 618	176	7 605	3 678	4 830	2 333	4 054	27 107	All in employment
Males									
75	499	8	285	215	41	123	189	202	Usually work from home
59	369	10	.	147	109	88	109	3 669	Sometimes work from home
700	12 241	89	4 089	1 701	2 501	1 007	1 678	10 125	Never work from home
4	10	0	0	0	0	5	147	954	Non responses
838	13 119	107	4 374	2 063	2 651	1 223	2 123	14 950	All in employment
Females									
25	327	7	187	210	85	118	149	441	Usually work from home
16	161	5	.	79	95	48	72	2 182	Sometimes work from home
492	7 001	57	3 044	1 326	1 999	940	1 608	8 870	Never work from home
2	10	0	0	0	0	3	102	665	Non responses
535	7 499	69	3 231	1 615	2 179	1 109	1 931	12 157	All in employment

⁽¹⁾ 1998.

⁽²⁾ 1997.

⁽³⁾ Greece 1998, Ireland 1997.

⁽⁴⁾ Ireland 1997.

Table 20
Male population aged 15 to 59 years in employment, by occupation and educational attainment level

Thousands

	EU-15 ⁽²⁾	EUR-11 ⁽⁴⁾	B	DK	D	EL ⁽¹⁾	E	F
Males								
Legislators and managers (1)	8 343	5 272	284	146	1 405	289	704	1 091
Less than upper secondary (L)	1 483	1 200	58	7	114	111	354	215
Upper secondary level (M)	3 594	2 112	96	81	636	125	157	406
Third level (H)	3 018	1 900	131	57	601	53	193	469
Non responses	247	60	0	0	54	0	0	0
Professionals (2)	10 509	7 527	348	208	2 734	242	765	1 448
Less than upper secondary (L)	221	194	6	(3)	46	(3)	10	66
Upper secondary level (M)	1 685	1 112	37	37	420	13	34	230
Third level (H)	8 455	6 154	305	168	2 203	227	720	1 151
Non responses	148	67	0	0	65	0	0	0
Technicians (3)	10 867	8 944	286	210	2 880	148	738	1 940
Less than upper secondary (L)	1 353	1 242	55	16	222	10	188	304
Upper secondary level (M)	6 038	5 018	134	125	1 606	78	235	911
Third level (H)	3 308	2 588	98	69	960	60	314	725
Non responses	168	96	0	0	91	0	0	0
Clerks (4)	6 361	4 842	229	94	1 399	161	530	750
Less than upper secondary (L)	1 509	1 321	54	19	195	23	197	243
Upper secondary level (M)	3 766	2 766	99	66	946	122	184	384
Third level (H)	933	704	76	9	212	16	149	123
Non responses	153	52	0	0	45	0	0	0
Services and sales workers (5)	6 590	4 990	119	85	984	222	789	748
Less than upper secondary (L)	2 508	2 264	47	19	182	84	508	263
Upper secondary level (M)	3 340	2 264	60	54	598	121	181	431
Third level (H)	561	399	12	12	154	16	100	54
Non responses	181	64	0	0	50	0	0	0
Agriculture/ fishery workers (6)	3 125	2 533	56	48	468	285	456	675
Less than upper secondary (L)	1 696	1 363	31	18	101	239	387	265
Upper secondary level (M)	1 155	948	23	29	268	40	46	374
Third level (H)	189	165	(3)	.	83	5	23	36
Non responses	84	57	0	0	17	0	0	0
Craft/related trades workers (7)	20 584	16 581	405	277	5 647	527	2 104	2 817
Less than upper secondary (L)	8 416	7 581	227	54	1 089	338	1 590	1 013
Upper secondary level (M)	10 372	7 642	166	209	3 671	172	284	1 726
Third level (H)	1 344	1 095	12	13	709	17	230	78
Non responses	452	263	0	0	178	0	0	0
Plant and machine operators (8)	10 769	8 308	295	145	2 181	263	1 185	1 912
Less than upper secondary (L)	5 036	4 399	178	66	578	168	904	923
Upper secondary level (M)	4 803	3 483	107	77	1 411	87	176	934
Third level (H)	421	321	10	.	114	8	105	56
Non responses	509	105	0	1	78	0	0	0
Elementary occupations (9)	6 160	4 847	170	162	1 222	103	1 017	705
Less than upper secondary (L)	3 488	3 011	111	87	418	73	823	391
Upper secondary level (M)	2 132	1 497	53	69	648	27	131	284
Third level (H)	249	194	5	5	66	(3)	63	31
Non responses	291	146	0	0	90	0	0	0
Armed forces (0)	1 049	867	35	15	214	38	63	258
Less than upper secondary (L)	264	257	14	.	22	(4)	11	70
Upper secondary level (M)	579	477	15	11	152	15	34	145
Third level (H)	187	127	5	(3)	35	20	19	42
Non responses	19	6	0	0	5	0	0	0
All in Employment	85 134	65 478	2 232	1 393	19 394	2 278	8 350	12 379
Less than upper secondary (L)	26 231	23 089	786	293	3 039	1 053	4 972	3 767
Upper secondary level (M)	37 861	27 708	790	760	10 484	800	1 463	5 843
Third level (H)	18 766	13 744	656	339	5 177	424	1 915	2 768
Non responses	2 275	938	0	1	694	0	0	1

⁽¹⁾ 1998.⁽²⁾ 1997.⁽³⁾ Greece 1998. Ireland 1997.⁽⁴⁾ Ireland 1997.

Table 20
Male population aged 15 to 59 years in employment, by occupation and educational attainment level

Thousands									
IRL ⁽²⁾	I	L	NL	A	P	FIN	S	UK	
Males									
80	497	7	641	204	201	158	132	2 504	Legislators and managers (1)
20	129	(1)	130	7	139	33	15	150	Less than upper secondary (L)
29	239	3	314	151	37	44	60	1 215	Upper secondary level (M)
31	128	3	194	46	23	80	56	952	Third level (H)
0	1	0	3	0	2	0	0	187	Non responses
112	880	17	731	178	139	175	292	2 239	Professionals (2)
10	11	.	26	.	8	8	.	15	Less than upper secondary (L)
14	107	(1)	154	62	13	40	55	468	Upper secondary level (M)
87	761	16	551	115	119	127	231	1 676	Third level (H)
0	0	0	1	0	0	0	1	80	Non responses
34	1 820	18	627	265	173	162	399	1 166	Technicians (3)
7	271	.	80	10	83	22	42	42	Less than upper secondary (L)
13	1 341	15	392	241	69	60	194	624	Upper secondary level (M)
14	205	2	155	14	21	79	163	428	Third level (H)
0	3	1	1	0	0	0	0	71	Non responses
52	1 200	13	293	172	165	39	114	1 149	Clerks (4)
15	382	4	98	21	98	13	29	117	Less than upper secondary (L)
25	744	8	152	146	60	17	75	737	Upper secondary level (M)
12	70	.	42	5	6	8	10	194	Third level (H)
0	3	1	1	0	1	0	1	101	Non responses
89	1 513	6	286	157	230	69	150	1 143	Services and sales workers (5)
37	895	3	99	26	186	18	28	113	Less than upper secondary (L)
39	576	3	172	130	36	39	103	798	Upper secondary level (M)
14	32	.	14	.	(4)	12	17	117	Third level (H)
0	9	0	0	0	4	0	2	116	Non responses
77	410	3	77	91	138	80	61	199	Agriculture/ fishery workers (6)
54	314	2	42	27	108	33	25	50	Less than upper secondary (L)
15	80	(1)	33	63	(4)	41	30	109	Upper secondary level (M)
8	6	.	13	Third level (H)
0	14	0	0	0	25	0	0	26	Non responses
143	3 111	23	725	564	785	258	397	2 802	Craft/related trades workers (7)
82	2 338	10	340	115	706	73	119	324	Less than upper secondary (L)
44	718	11	370	447	29	174	256	2 093	Upper secondary level (M)
17	22	.	14	2	.	11	20	198	Third level (H)
0	33	1	1	0	49	0	1	188	Non responses
103	1 495	12	419	264	288	152	344	1 710	Plant and machine operators (8)
60	1 085	8	254	85	266	58	129	274	Less than upper secondary (L)
31	389	4	156	178	11	86	193	964	Upper secondary level (M)
12	9	.	(8)	.	.	7	22	68	Third level (H)
0	13	0	1	0	11	0	0	403	Non responses
86	934	6	293	122	218	74	65	982	Elementary occupations (9)
60	734	4	200	56	181	33	26	292	Less than upper secondary (L)
21	163	2	87	64	10	35	32	506	Upper secondary level (M)
6	10	.	(5)	.	.	5	.	41	Third level (H)
0	27	0	2	0	26	0	1	143	Non responses
.	211	.	41	.	34	11	13	116	Armed forces (0)
.	109	.	(10)	.	20	.	.	.	Less than upper secondary (L)
.	91	.	26	.	10	(4)	.	73	Upper secondary level (M)
.	9	.	(5)	.	(4)	7	10	29	Third level (H)
0	1	0	0	0	0	0	0	13	Non responses
778	12 427	105	4 239	2 019	2 372	1 183	1 971	14 014	All in Employment
345	6 387	31	1 324	348	1 796	294	420	1 378	Less than upper secondary (L)
230	4 651	48	1 894	1 483	279	543	1 003	7 590	Upper secondary level (M)
201	1 285	22	1 010	187	178	344	541	3 717	Third level (H)
1	105	4	11	0	119	2	7	1 329	Non responses

⁽¹⁾ 1998.

⁽²⁾ 1997.

⁽³⁾ Greece 1998, Ireland 1997.

⁽⁴⁾ Ireland 1997.

Table 21
Female population aged 15 to 59 years in employment, by occupation and educational attainment level

Thousands

	EU-15 ⁽³⁾	EUR-11 ⁽⁴⁾	B	DK	D	EL ⁽¹⁾	E	F
Females								
Legislators and managers (1)	3 600	2 088	134	43	504	102	312	549
Less than upper secondary (L)	762	609	32	7	73	39	191	140
Upper secondary level (M)	1 625	844	49	22	288	44	63	198
Third level (H)	1 098	614	53	13	125	19	57	211
Non responses	115	22	0	0	19	0	0	0
Professionals (2)	8 692	6 134	416	130	1 668	224	763	907
Less than upper secondary (L)	136	116	11	.	29	.	5	28
Upper secondary level (M)	1 422	1 110	58	20	261	14	22	97
Third level (H)	7 042	4 872	347	108	1 344	209	735	783
Non responses	92	35	0	0	35	0	0	0
Technicians (3)	10 874	9 017	146	284	4 071	126	456	1 987
Less than upper secondary (L)	1 187	1 084	14	10	469	.	80	194
Upper secondary level (M)	5 798	4 941	52	107	2 539	72	143	631
Third level (H)	3 692	2 873	80	166	949	51	233	1 162
Non responses	198	119	0	0	115	0	0	0
Clerks (4)	13 475	9 614	378	227	3 081	211	777	2 407
Less than upper secondary (L)	2 404	2 014	65	27	467	16	189	566
Upper secondary level (M)	8 922	6 110	197	184	2 223	174	290	1 428
Third level (H)	1 825	1 372	117	16	280	20	298	413
Non responses	324	118	0	0	111	0	0	0
Services and sales workers (5)	13 446	9 628	291	321	3 033	240	1 075	2 091
Less than upper secondary (L)	4 761	3 955	120	106	705	105	611	897
Upper secondary level (M)	7 326	4 914	146	200	2 003	122	300	1 093
Third level (H)	883	612	25	15	205	13	163	101
Non responses	477	146	0	0	120	0	0	0
Agriculture/ fishery workers (6)	1 443	1 172	26	8	241	215	140	259
Less than upper secondary (L)	890	678	15	5	59	194	129	144
Upper secondary level (M)	437	385	8	(3)	157	20	7	101
Third level (H)	.	47	.	.	19	.	(3)	14
Non responses	64	63	0	0	5	0	0	0
Craft/related trades workers (7)	2 417	2 064	36	15	608	77	176	232
Less than upper secondary (L)	1 367	1 218	17	(3)	187	52	143	116
Upper secondary level (M)	873	716	16	11	354	22	21	103
Third level (H)	112	89	(3)	.	46	.	12	12
Non responses	66	41	0	1	21	0	0	0
Plant and machine operators (8)	2 309	1 818	56	49	407	40	218	491
Less than upper secondary (L)	1 366	1 159	31	32	174	27	175	297
Upper secondary level (M)	821	592	25	16	205	12	30	182
Third level (H)	57	44	.	.	11	.	13	12
Non responses	65	23	0	0	17	0	0	0
Elementary occupations (9)	6 492	5 211	166	135	1 448	118	883	1 056
Less than upper secondary (L)	4 078	3 488	117	79	664	84	757	723
Upper secondary level (M)	1 961	1 433	45	52	654	27	87	308
Third level (H)	178	131	(4)	5	45	7	39	25
Non responses	274	160	0	0	85	0	0	0
Armed forces (0)	.	37	(4)	.	.	6	.	22
Less than upper secondary (L)	(4)
Upper secondary level (M)	(4)	.	14
Third level (H)	(4)
Non responses	0	0	0	0	0	0	0	0
All in Employment	63 406	47 380	1 656	1 214	15 255	1 357	4 801	10 008
Less than upper secondary (L)	17 141	14 509	424	271	2 890	518	2 282	3 112
Upper secondary level (M)	29 539	21 381	600	618	8 779	512	964	4 158
Third level (H)	15 034	10 743	631	323	3 042	326	1 555	2 737
Non responses	1 693	747	0	1	545	0	0	2

⁽¹⁾ 1998.⁽²⁾ 1997.⁽³⁾ Greece 1998, Ireland 1997.⁽⁴⁾ Ireland 1997.

Table 21
Female population aged 15 to 59 years in employment, by occupation and educational attainment level

Thousands

IRL ⁽²⁾	I	L	NL	A	P	FIN	S	UK	
Females									
35	112	3	203	78	95	62	54	1 313	Legislators and managers (1)
6	28	(1)	53	7	68	9	.	102	Less than upper secondary (L)
14	48	2	97	55	13	17	20	695	Upper secondary level (M)
15	36	(1)	53	16	12	36	28	424	Third level (H)
0	0	0	0	0	3	0	0	93	Non responses
113	1 103	11	571	174	169	238	306	1 899	Professionals (2)
(4)	(5)	.	19	.	7	6	.	11	Less than upper secondary (L)
17	429	.	108	72	16	31	48	230	Upper secondary level (M)
93	668	10	444	101	146	201	251	1 602	Third level (H)
0	0	0	0	0	0	0	0	56	Non responses
16	1 077	14	669	231	154	196	369	1 079	Technicians (3)
.	167	.	77	16	39	27	28	62	Less than upper secondary (L)
5	750	12	455	196	47	111	114	564	Upper secondary level (M)
10	157	2	136	18	68	58	227	375	Third level (H)
0	3	1	1	0	0	0	0	78	Non responses
131	1 458	15	603	344	264	158	286	3 137	Clerks (4)
17	280	3	221	38	131	37	52	294	Less than upper secondary (L)
78	1 081	10	332	299	116	56	198	2 256	Upper secondary level (M)
37	94	.	47	6	15	64	35	381	Third level (H)
0	3	1	2	0	1	0	1	205	Non responses
137	1 423	10	619	337	403	208	560	2 698	Services and sales workers (5)
60	810	5	258	89	334	66	112	483	Less than upper secondary (L)
59	572	4	326	245	50	116	406	1 684	Upper secondary level (M)
18	32	.	33	3	5	26	42	202	Third level (H)
0	10	0	1	0	14	1	1	329	Non responses
6	172	(1)	35	90	157	46	24	24	Agriculture/ fishery workers (6)
(3)	135	(1)	19	51	106	17	.	.	Less than upper secondary (L)
.	29	.	16	39	.	24	15	14	Upper secondary level (M)
0	7	0	0	0	50	0	0	0	Third level (H)
34	543	(1)	53	61	288	32	25	237	Non responses
18	410	.	25	24	266	11	.	85	Craft/related trades workers (7)
14	120	.	25	36	8	18	14	109	Less than upper secondary (L)
(3)	(7)	18	Upper secondary level (M)
0	6	0	0	0	13	0	0	24	Third level (H)
14	388	(1)	63	54	89	36	73	329	Non responses
6	304	(1)	40	32	84	15	26	123	Plant and machine operators (8)
7	79	.	22	22	(3)	19	46	155	Less than upper secondary (L)
.	Upper secondary level (M)
0	3	0	0	0	2	0	0	42	Third level (H)
29	686	11	274	216	342	98	126	902	Non responses
20	540	10	198	133	282	44	59	369	Elementary occupations (9)
7	116	(1)	71	82	10	51	60	390	Less than upper secondary (L)
.	(6)	.	(5)	.	.	(4)	.	29	Upper secondary level (M)
0	24	0	0	0	49	0	1	114	Third level (H)
.	Non responses
.	Armed forces (0)
.	Less than upper secondary (L)
.	Upper secondary level (M)
.	Third level (H)
0	0	0	0	0	0	0	0	0	Non responses
517	7 271	67	3 181	1 584	1 961	1 077	-1 825	11 631	All in Employment
136	2 760	21	943	392	1 318	231	305	1 538	Less than upper secondary (L)
201	3 406	31	1 489	1 046	263	445	921	6 106	Upper secondary level (M)
179	1 047	13	744	147	248	400	595	3 046	Third level (H)
1	58	3	5	0	133	1	3	942	Non responses

(1) 1998.

(2) 1997.

(3) Greece 1998. Ireland 1997.

(4) Ireland 1997.

EMPLOYMENT

Self-employment

Table 22

Self-employment by age group and educational attainment level

Thousands

	EU-15 ⁽¹⁾	EUR-11 ⁽⁴⁾	B	DK	D	EL ⁽³⁾	E	F
Males and Females								
15-24 years	582	433	16	6	51	33	85	31
Less than upper secondary (L)	228	194	(4)	.	9	12	48	(7)
Upper secondary level (M)	296	199	8	5	35	19	24	17
Third level (H)	.	33	(3)	.	.	.	13	(6)
Non responses	12	7	0	0	3	0	0	0
25-49 years	13 953	10 904	409	122	2 251	728	1 615	1 631
Less than upper secondary (L)	4 478	3 861	95	16	195	350	962	360
Upper secondary level (M)	5 666	4 161	157	74	992	232	301	791
Third level (H)	3 522	2 768	157	33	993	146	353	479
Non responses	287	114	0	0	71	0	0	0
50-59 years	5 297	4 039	113	73	877	307	674	620
Less than upper secondary (L)	2 425	1 989	49	9	97	236	555	219
Upper secondary level (M)	1 596	1 111	33	46	350	42	50	267
Third level (H)	1 065	801	31	19	369	29	70	134
Non responses	211	138	0	0	60	0	0	0
All Self-employed aged 15-59	19 832	15 376	538	201	3 179	1 068	2 375	2 282
Less than upper secondary (L)	7 132	6 044	148	25	301	598	1 565	587
Upper secondary level (M)	7 557	5 472	199	124	1 378	293	374	1 076
Third level (H)	4 632	3 602	191	52	1 366	177	436	619
Non responses	510	258	0	0	134	0	0	1
Males								
15-24 years	394	284	11	(4)	34	23	60	22
Less than upper secondary (L)	163	135	(3)	.	.	9	37	(5)
Upper secondary level (M)	193	124	7	(3)	22	13	14	13
Third level (H)	8	(4)
Non responses	10	5	0	0	2	0	0	0
25-49 years	10 106	7 856	275	95	1 603	551	1 196	1 227
Less than upper secondary (L)	3 318	2 839	66	10	129	278	733	273
Upper secondary level (M)	4 187	3 054	108	60	702	176	218	653
Third level (H)	2 395	1 892	101	24	723	97	245	300
Non responses	206	71	0	0	49	0	0	0
50-59 years	3 907	2 955	82	55	642	245	500	461
Less than upper secondary (L)	1 747	1 416	34	5	59	188	405	143
Upper secondary level (M)	1 194	823	25	36	233	34	37	214
Third level (H)	838	640	23	14	304	24	58	104
Non responses	128	76	0	0	46	0	0	0
All Self-employed aged 15-59	14 408	11 094	368	154	2 279	819	1 756	1 709
Less than upper secondary (L)	5 228	4 390	103	15	194	476	1 176	421
Upper secondary level (M)	5 574	4 001	140	99	958	222	269	880
Third level (H)	3 261	2 552	126	39	1 029	121	311	408
Non responses	345	152	0	0	97	0	0	1
Females								
15-24 years	188	149	(4)	.	17	10	25	9
Less than upper secondary (L)	66	59	.	.	.	(3)	11	.
Upper secondary level (M)	103	75	.	.	13	6	9	(5)
Third level (H)	5	.
Non responses	2	1	0	0	0	0	0	0
25-49 years	3 846	3 048	134	27	648	177	420	404
Less than upper secondary (L)	1 160	1 021	29	5	66	72	229	87
Upper secondary level (M)	1 478	1 108	49	13	290	56	83	138
Third level (H)	1 127	876	56	9	270	49	108	179
Non responses	81	43	0	0	22	0	0	0
50-59 years	1 390	1 085	31	18	235	61	174	159
Less than upper secondary (L)	678	573	15	(4)	38	48	149	76
Upper secondary level (M)	402	289	8	10	117	8	13	53
Third level (H)	227	161	8	(4)	66	5	11	30
Non responses	83	62	0	0	15	0	0	0
All Self-employed aged 15-59	5 424	4 282	170	47	900	249	619	572
Less than upper secondary (L)	1 904	1 654	45	9	107	123	389	165
Upper secondary level (M)	1 983	1 471	59	25	420	70	105	196
Third level (H)	1 371	1 051	66	13	337	55	125	211
Non responses	166	106	0	0	37	0	0	0

⁽¹⁾ 1998.⁽²⁾ 1997.⁽³⁾ Greece 1998, Ireland 1997.⁽⁴⁾ Ireland 1997.

Table 22

Self-employment by age group and educational attainment level

Thousands

IRL ⁽²⁾	I	L	NL	A	P	FIN	S	UK	
Males and Females									
7	156	.	29	10	41	8	11	98	15-24 years
(3)	69	.	17	2	32	.	.	19	Less than upper secondary (L)
(3)	82	.	12	7	6	5	.	64	Upper secondary level (M)
.	10	Third level (H)
0	2	0	0	0	2	0	0	5	Non responses
161	3 300	10	512	265	564	185	243	1 956	25-49 years
77	1 515	(1)	115	47	451	42	48	204	Less than upper secondary (L)
46	1 289	5	249	179	54	97	134	1 064	Upper secondary level (M)
39	483	4	147	39	30	45	59	515	Third level (H)
0	13	0	1	0	29	0	1	172	Non responses
56	1 069	3	185	98	260	85	125	753	50-59 years
38	718	(1)	55	29	187	41	42	149	Less than upper secondary (L)
10	228	(1)	83	57	5	27	55	342	Upper secondary level (M)
8	104	(1)	47	12	10	17	27	189	Third level (H)
0	19	0	1	0	57	0	0	73	Non responses
225	4 525	14	726	372	865	277	379	2 807	All Self-employed aged 15-59
117	2 303	2	187	79	671	85	93	372	Less than upper secondary (L)
59	1 599	7	344	243	65	129	198	1 470	Upper secondary level (M)
49	590	5	194	51	41	62	86	714	Third level (H)
0	33	0	1	0	88	1	1	251	Non responses
Males									
6	97	.	16	6	27	5	.	76	15-24 years
(3)	47	.	(9)	.	21	.	.	16	Less than upper secondary (L)
.	47	.	(7)	4	(4)	(3)	.	48	Upper secondary level (M)
.	Third level (H)
0	2	0	0	0	1	0	0	5	Non responses
135	2 450	7	330	173	333	126	178	1 426	25-49 years
71	1 169	(1)	79	19	268	33	38	153	Less than upper secondary (L)
37	942	3	163	128	35	64	98	799	Upper secondary level (M)
28	331	3	88	27	18	29	41	340	Third level (H)
0	8	0	1	0	12	0	1	134	Non responses
48	817	2	134	64	151	54	92	559	50-59 years
34	539	.	36	14	124	26	33	105	Less than upper secondary (L)
7	182	(1)	63	41	(4)	16	41	260	Upper secondary level (M)
6	83	(1)	34	9	7	12	18	142	Third level (H)
0	13	0	1	0	15	0	0	52	Non responses
189	3 365	9	481	243	511	185	278	2 062	All Self-employed aged 15-59
107	1 755	(1)	124	34	413	61	73	274	Less than upper secondary (L)
46	1 171	4	233	173	44	84	144	1 107	Upper secondary level (M)
36	415	3	122	36	25	41	59	490	Third level (H)
0	23	0	1	0	29	0	1	191	Non responses
Females									
.	59	.	13	4	14	(3)	.	22	15-24 years
.	22	.	(8)	.	11	.	.	.	Less than upper secondary (L)
.	36	.	.	3	.	.	.	16	Upper secondary level (M)
.	Third level (H)
0	0	0	0	0	1	0	0	1	Non responses
26	850	3	182	92	231	59	64	530	25-49 years
6	346	.	36	28	184	9	10	52	Less than upper secondary (L)
9	347	2	86	51	19	33	37	265	Upper secondary level (M)
11	152	(1)	59	12	12	16	18	175	Third level (H)
0	4	0	0	0	16	0	0	38	Non responses
8	252	(1)	51	34	109	30	33	194	50-59 years
(3)	179	.	19	15	63	15	9	44	Less than upper secondary (L)
(3)	46	(1)	20	16	.	10	14	82	Upper secondary level (M)
.	21	.	12	2	(3)	5	10	47	Third level (H)
0	6	0	0	0	42	0	0	21	Non responses
36	1 161	4	245	130	354	92	101	745	All Self-employed aged 15-59
10	547	(1)	63	44	258	25	20	98	Less than upper secondary (L)
13	429	2	110	70	21	45	54	363	Upper secondary level (M)
13	175	(1)	72	15	16	22	27	225	Third level (H)
0	10	0	0	0	59	0	0	59	Non responses

(1) 1998.

(2) 1997.

(3) Greece 1998, Ireland 1997.

(4) Ireland 1997.

Table 23

Self-Employment by economic activity

Thousands

	EU-15 ⁽²⁾	EUR-11	B	DK	D	EL ⁽¹⁾	E	F
Males and Females								
Agriculture (A-B)	3 612	2 873	51	35	322	422	501	536
Industry (C-F)	5 024	3 763	100	54	744	224	596	502
Mining and quarrying (C)							(4)	
Manufacturing (D)	2 319	1 892	38	25	366	129	296	215
Electricity, gaz,water supply (E)								
Construction (F)	2 664	1 837	61	29	374	94	295	285
Services (G-Q)	13 696	10 567	439	134	2 527	642	1 553	1 385
Wholesale and retail,repairs (G)	4 944	4 024	161	44	684	299	701	446
Hotels and restaurants (H)	1 361	1 122	50	10	249	84	234	172
Transports, communications (I)	1 012	710	20	10	156	66	196	72
Financial intermediation (J)	357	311	15		127	5	28	31
Real estate,business activit. (K)	2 755	1 981	72	41	581	99	195	248
Public administration (L)								
Other services (M-Q)	3 233	2 395	121	29	730	90	199	413
Non responses	102	100	0	1	0	0	0	0
All in self-employment	22 434	17 303	590	224	3 594	1 288	2 650	2 423
Males								
Agriculture (A-B)	2 686	2 098	41	33	280	322	394	414
Industry (C-F)	4 494	3 340	90	47	665	204	533	460
Mining and quarrying (C)							(3)	
Manufacturing (D)	1 874	1 536	31	19	306	109	241	184
Electricity, gaz,water supply (E)								
Construction (F)	2 584	1 773	59	28	354	94	288	274
Services (G-Q)	9 137	7 024	278	93	1 665	469	1 024	926
Wholesale and retail,repairs (G)	3 419	2 747	110	33	465	220	427	322
Hotels and restaurants (H)	857	704	28	6	150	65	160	110
Transports, communications (I)	911	637	18	9	130	63	186	62
Financial intermediation (J)	279	247	13		104	(3)	21	24
Real estate,business activit. (K)	2 049	1 465	52	31	432	70	144	183
Public administration (L)								
Other services (M-Q)	1 603	1 213	57	13	383	47	87	224
Non responses	48	47	0	1	0	0	0	0
All in self-employment	16 365	12 509	410	173	2 610	995	1 951	1 800
Females								
Agriculture (A-B)	925	775	10		42	101	107	122
Industry (C-F)	530	423	10	7	80	20	63	42
Mining and quarrying (C)								
Manufacturing (D)	446	356	7	6	60	20	55	31
Electricity, gaz,water supply (E)								
Construction (F)	80	64	(3)		20		7	11
Services (G-Q)	4 559	3 543	161	42	862	173	529	459
Wholesale and retail,repairs (G)	1 525	1 278	51	11	219	78	274	124
Hotels and restaurants (H)	504	418	22	(4)	99	18	74	62
Transports, communications (I)	101	73			26		10	10
Financial intermediation (J)	78	65	(3)		23		8	(8)
Real estate,business activit. (K)	706	517	20	10	148	28	51	65
Public administration (L)								
Other services (M-Q)	1 630	1 182	64	16	347	43	112	189
Non responses	54	53	0	0	0	0	0	0
All in self-employment	6 069	4 794	181	51	984	293	699	623

⁽¹⁾ 1998.⁽²⁾ Greece 1998.

Table 23

Self-Employment by economic activity

Thousands

IRL	I	L	NL	A	P	FIN	S	UK	
Males and Females									
98	554	2	115	141	458	95	79	202	Agriculture (A-B)
58	1 281	2	106	51	265	58	89	894	Industry (C-F)
	(5)								Mining and quarrying (C)
21	722	(1)	45	35	123	28	41	232	Manufacturing (D)
	8				5				Electricity, gaz,water supply (E)
36	546	(1)	60	15	136	28	47	657	Construction (F)
127	3 204	11	493	208	470	149	276	2 077	Services (G-Q)
38	1 505	3	129	66	244	48	83	495	Wholesale and retail,repairs (G)
16	252	(1)	37	37	64	10	22	124	Hotels and restaurants (H)
17	174		19	11	22	22	26	201	Transports, communications (I)
(3)	83		13	3	6			38	Financial intermediation (J)
26	610	2	127	37	51	33	81	554	Real estate,business activit. (K)
	16								Public administration (L)
27	564	3	166	54	81	36	62	657	Other services (M-Q)
1	0	0	98	0	0	1	0	2	Non responses
283	5 040	15	812	400	1 193	302	444	3 176	All in self-employment
Males									
92	427	2	95	77	212	64	64	170	Agriculture (A-B)
53	1 130	2	92	45	221	48	79	824	Industry (C-F)
	(4)								Mining and quarrying (C)
18	590		34	30	82	20	34	175	Manufacturing (D)
	8				(4)				Electricity, gaz,water supply (E)
35	529	(1)	58	14	134	26	44	645	Construction (F)
90	2 227	7	318	135	262	92	190	1 362	Services (G-Q)
30	1 074	2	93	46	146	32	57	362	Wholesale and retail,repairs (G)
9	159	(1)	24	20	37	5	16	66	Hotels and restaurants (H)
15	161		14	9	20	20	24	178	Transports, communications (I)
	66		10		(4)			27	Financial intermediation (J)
21	452	2	93	28	35	23	63	420	Real estate,business activit. (K)
	8								Public administration (L)
13	306	2	82	31	17	11	28	303	Other services (M-Q)
1	0	0	46	0	0	0	0	0	Non responses
236	3 785	10	550	258	695	205	333	2 355	All in self-employment
Females									
6	127		20	63	246	30	15	33	Agriculture (A-B)
(4)	151		14	6	43	10	10	70	Industry (C-F)
									Mining and quarrying (C)
(3)	132		12	5	41	8		56	Manufacturing (D)
									Electricity, gaz,water supply (E)
	17							13	Construction (F)
37	977	4	176	73	208	57	86	716	Services (G-Q)
8	431	(1)	36	21	98	15	26	132	Wholesale and retail,repairs (G)
7	93	(1)	14	16	26	5		58	Hotels and restaurants (H)
	13		(5)	2				23	Transports, communications (I)
	18							11	Financial intermediation (J)
6	157	(1)	34	9	16	10	18	134	Real estate,business activit. (K)
	8								Public administration (L)
14	258	(1)	84	23	64	25	34	354	Other services (M-Q)
0	0	0	52	0	0	0	0	2	Non responses
47	1 255	5	262	142	498	98	111	820	All in self-employment

(1) 1998.

(2) Greece 1998.

Table 24

Self-Employment by occupation

Thousands

	EU-15 ⁽³⁾	EUR-11 ⁽⁴⁾	B	DK	D	EL ⁽¹⁾	E	F
Males and Females								
Legislators and managers (1)	5 323	4 159	235	74	1 021	383	899	729
Professionals (2)	3 125	2 298	110	34	817	126	205	344
Technicians (3)	2 324	1 841	62	23	534	35	146	161
Clerks (4)	293	174	5	.	52	7	32	.
Services and sales workers (5)	2 065	1 841	47	9	197	39	141	61
Agriculture/ fishery workers (6)	3 289	2 629	47	29	317	415	469	540
Craft/related trades workers (7)	4 154	3 026	68	36	531	194	459	520
Plant and machine operators (8)	1 012	698	9	11	81	74	248	61
Elementary occupations (9)	657	447	6	(4)	38	16	50	.
Armed forces (0)
Non responses	175	174	0	0	4	0	0	7
All in self-employment	22 418	17 287	590	224	3 594	1 288	2 650	2 423
Males								
Legislators and managers (1)	3 751	2 940	163	58	717	288	584	512
Professionals (2)	2 174	1 575	72	25	574	82	134	230
Technicians (3)	1 648	1 329	37	12	366	26	114	83
Clerks (4)	105	79	.	.	28	(4)	20	.
Services and sales workers (5)	971	898	17	(4)	65	20	47	16
Agriculture/ fishery workers (6)	2 429	1 896	39	27	267	315	366	419
Craft/related trades workers (7)	3 854	2 780	66	35	495	178	426	480
Plant and machine operators (8)	916	623	9	9	69	72	225	53
Elementary occupations (9)	393	265	(4)	(3)	25	10	34	.
Armed forces (0)
Non responses	115	115	0	0	3	0	0	6
All in self-employment	16 356	12 499	410	173	2 610	995	1 951	1 800
Females								
Legislators and managers (1)	1 572	1 219	72	17	304	94	314	217
Professionals (2)	951	722	38	8	244	44	71	113
Technicians (3)	676	512	25	12	169	9	33	78
Clerks (4)	188	95	.	.	23	(3)	12	.
Services and sales workers (5)	1 094	943	30	6	132	19	94	44
Agriculture/ fishery workers (6)	860	733	8	.	49	100	103	122
Craft/related trades workers (7)	300	247	(3)	.	36	16	33	39
Plant and machine operators (8)	96	75	.	(3)	12	.	24	(8)
Elementary occupations (9)	265	182	.	.	13	6	16	.
Armed forces (0)
Non responses	60	60	0	0	1	0	0	1
All in self-employment	6 062	4 787	181	51	984	293	699	623

⁽¹⁾ 1998.⁽²⁾ 1997.⁽³⁾ Greece 1998, Ireland 1997.⁽⁴⁾ Ireland 1997.

Table 24

Self-Employment by occupation

Thousands

IRL ⁽²⁾	I	L	NL	A	P	FIN	S	UK	
Males and Females									
25	372	5	359	120	290	103	58	649	Legislators and managers (1)
24	528	4	160	50	33	23	57	612	Professionals (2)
12	723	(1)	97	42	39	23	74	351	Technicians (3)
.	61	.	(10)	3	7	(3)	.	103	Clerks (4)
34	1 175	(1)	38	30	98	18	56	119	Services and sales workers (5)
104	472	2	(8)	136	440	92	71	145	Agriculture/ fishery workers (6)
37	1 103	(1)	82	9	189	27	73	824	Craft/related trades workers (7)
21	217	.	20	5	26	10	39	190	Plant and machine operators (8)
9	247	.	19	4	70	(3)	.	183	Elementary occupations (9)
.	Armed forces (0)
0	142	0	19	0	0	1	0	0	Non responses
267	5 040	15	812	400	1 193	302	444	3 176	All in self-employment
Males									
17	306	3	269	90	201	78	42	423	Legislators and managers (1)
17	377	3	100	37	19	12	41	451	Professionals (2)
10	591	(1)	57	27	30	15	55	226	Technicians (3)
.	21	21	Clerks (4)
22	669	.	(9)	15	35	(3)	24	25	Services and sales workers (5)
98	364	2	(5)	75	200	62	59	132	Agriculture/ fishery workers (6)
35	1 010	(1)	72	8	162	23	70	791	Craft/related trades workers (7)
20	194	.	16	5	24	9	36	177	Plant and machine operators (8)
8	158	.	(9)	2	23	.	.	109	Elementary occupations (9)
.	Armed forces (0)
0	95	0	10	0	0	0	0	0	Non responses
226	3 785	10	550	258	695	205	333	2 355	All in self-employment
Females									
8	66	2	90	31	89	25	16	226	Legislators and managers (1)
7	151	(1)	60	14	14	10	16	161	Professionals (2)
.	132	(1)	41	14	9	8	19	124	Technicians (3)
.	40	.	(6)	2	6	(3)	.	82	Clerks (4)
12	506	(1)	30	16	63	16	32	94	Services and sales workers (5)
7	109	.	.	61	240	30	13	13	Agriculture/ fishery workers (6)
.	93	.	(10)	.	27	(3)	.	33	Craft/related trades workers (7)
.	22	13	Plant and machine operators (8)
.	88	.	(10)	.	48	.	.	74	Elementary occupations (9)
.	Armed forces (0)
0	47	0	9	0	0	1	0	0	Non responses
41	1 255	5	262	142	498	98	111	820	All in self-employment

⁽¹⁾ 1998.

⁽²⁾ 1997.

⁽³⁾ Greece 1998, Ireland 1997.

⁽⁴⁾ Ireland 1997.

EMPLOYMENT

Employees

Table 25

Employees by age group and educational attainment level

Thousands

	EU-15 ⁽³⁾	EUR-11 ⁽⁴⁾	B	DK	D	EL ⁽¹⁾	E	F
Males and Females								
15-24 years	16 639	11 968	298	393	3 989	271	1 581	1 876
Less than upper secondary (L)	5 819	5 160	91	215	1 658	82	884	517
Upper secondary level (M)	8 759	5 507	146	171	2 002	171	385	987
Third level (H)	1 702	1 082	61	7	123	18	312	372
Non responses	360	220	0	0	205	0	0	0
25-49 years	88 174	67 847	2 511	1 519	21 500	1 625	7 266	14 626
Less than upper secondary (L)	21 791	19 408	746	226	2 886	477	3 470	4 154
Upper secondary level (M)	41 921	31 471	892	827	12 783	670	1 451	6 628
Third level (H)	22 474	16 247	872	465	5 273	477	2 345	3 843
Non responses	1 989	721	0	1	557	0	0	1
50-59 years	21 455	15 710	453	469	5 760	294	1 598	3 297
Less than upper secondary (L)	7 268	5 904	187	89	1 019	159	1 088	1 476
Upper secondary level (M)	8 320	5 961	119	244	2 986	71	162	1 173
Third level (H)	4 816	3 414	147	135	1 429	63	348	648
Non responses	1 051	432	0	0	326	0	0	0
All Employees aged 15-59 years	126 269	95 525	3 261	2 381	31 248	2 190	10 445	19 799
Less than upper secondary (L)	34 878	30 472	1 024	530	5 562	718	5 442	6 147
Upper secondary level (M)	59 000	42 939	1 157	1 242	17 772	912	1 997	8 788
Third level (H)	28 992	20 742	1 080	607	6 825	558	3 005	4 863
Non responses	3 399	1 373	0	2	1 088	0	0	1
Males								
15-24 years	8 960	6 513	162	199	2 084	152	935	1 035
Less than upper secondary (L)	3 548	3 155	57	121	952	63	586	340
Upper secondary level (M)	4 499	2 819	80	74	988	86	210	548
Third level (H)	721	423	25	5	37	(4)	139	147
Non responses	192	117	0	0	108	0	0	0
25-49 years	48 672	37 910	1 401	791	11 748	973	4 391	7 840
Less than upper secondary (L)	12 950	11 737	501	115	1 449	329	2 327	2 259
Upper secondary level (M)	22 739	17 183	483	456	6 871	393	846	3 714
Third level (H)	11 809	8 571	417	219	3 121	251	1 218	1 866
Non responses	1 173	419	0	1	307	0	0	0
50-59 years	12 312	9 322	294	244	3 245	215	1 137	1 758
Less than upper secondary (L)	4 066	3 440	123	39	434	118	794	731
Upper secondary level (M)	4 780	3 497	82	130	1 649	52	112	683
Third level (H)	2 922	2 155	89	75	984	45	232	343
Non responses	545	231	0	0	177	0	0	0
All Employees aged 15-59 years	69 943	53 746	1 857	1 235	17 078	1 340	6 463	10 633
Less than upper secondary (L)	20 563	18 331	681	276	2 835	510	3 706	3 330
Upper secondary level (M)	32 018	23 498	645	659	9 509	530	1 168	4 946
Third level (H)	15 452	11 150	530	299	4 142	299	1 589	2 357
Non responses	1 910	767	0	1	592	0	0	1
Females								
15-24 years	7 680	5 455	136	193	1 904	119	646	841
Less than upper secondary (L)	2 271	2 005	34	94	706	19	298	177
Upper secondary level (M)	4 260	2 688	66	98	1 015	86	175	439
Third level (H)	981	658	36	0	86	14	172	225
Non responses	168	103	0	0	97	0	0	0
25-49 years	39 503	29 936	1 110	728	9 752	652	2 875	6 786
Less than upper secondary (L)	8 841	7 671	245	111	1 437	148	1 143	1 895
Upper secondary level (M)	19 182	14 289	409	372	5 912	278	605	2 914
Third level (H)	10 664	7 675	456	246	2 152	227	1 127	1 977
Non responses	816	301	0	1	250	0	0	1
50-59 years	9 143	6 388	159	224	2 514	79	461	1 539
Less than upper secondary (L)	3 203	2 464	64	50	585	42	295	745
Upper secondary level (M)	3 541	2 464	37	114	1 337	19	50	490
Third level (H)	1 895	1 258	58	60	444	18	117	304
Non responses	505	201	0	0	149	0	0	0
All Employees aged 15-59 years	56 326	41 779	1 405	1 146	14 170	850	3 982	9 167
Less than upper secondary (L)	14 314	12 141	343	254	2 728	208	1 736	2 817
Upper secondary level (M)	26 982	19 441	511	583	8 263	382	830	3 842
Third level (H)	13 540	9 592	550	308	2 683	259	1 416	2 507
Non responses	1 489	606	0	1	496	0	0	1

(1) 1998.

(2) 1997.

(3) Greece 1998, Ireland 1997.

(4) Ireland 1997.

Table 25

Employees by age group and educational attainment level

Thousands

IRL ⁽²⁾	I	L	NL	A	P	FIN	S	UK	
Males and Females									
232	1 468	15	1 139	487	610	274	347	3 660	15-24 years
62	686	6	542	170	459	87	89	273	Less than upper secondary (L)
110	752	8	528	312	111	165	209	2 701	Upper secondary level (M)
60	24	(1)	69	6	32	22	46	549	Third level (H)
0	6	1	0	0	8	0	4	136	Non responses
700	10 795	123	4 503	2 216	2 302	1 306	2 216	14 967	25-49 years
230	4 564	37	1 163	365	1 583	210	312	1 367	Less than upper secondary (L)
230	4 810	56	2 098	1 624	327	573	1 147	7 805	Upper secondary level (M)
239	1 364	24	1 231	228	305	522	753	4 532	Third level (H)
1	57	5	11	0	87	2	4	1 263	Non responses
123	2 181	20	994	447	447	389	841	4 142	50-59 years
65	1 155	6	354	101	317	135	225	891	Less than upper secondary (L)
27	655	8	384	300	31	116	365	1 679	Upper secondary level (M)
30	325	6	252	46	46	137	250	955	Third level (H)
0	46	1	4	0	53	1	1	617	Non responses
1 055	14 445	158	6 636	3 150	3 358	1 969	3 405	22 769	All Employees aged 15-59 years
357	6 405	49	2 059	636	2 359	432	626	2 532	Less than upper secondary (L)
367	6 218	72	3 010	2 235	469	854	1 721	12 185	Upper secondary level (M)
329	1 713	31	1 552	279	383	681	1 049	6 036	Third level (H)
2	109	7	15	0	148	3	9	2 016	Non responses
Males									
123	856	8	577	258	335	140	179	1 916	15-24 years
40	452	3	305	101	272	47	44	164	Less than upper secondary (L)
56	390	4	250	156	50	87	112	1 409	Upper secondary level (M)
27	10	.	22	.	8	6	20	270	Third level (H)
0	4	0	0	0	5	0	2	73	Non responses
380	6 431	74	2 532	1 214	1 228	672	1 105	7 892	25-49 years
148	3 176	22	690	159	886	120	178	590	Less than upper secondary (L)
110	2 562	34	1 144	939	160	320	577	4 131	Upper secondary level (M)
121	653	14	691	117	122	231	347	2 421	Third level (H)
1	41	3	7	0	60	1	3	750	Non responses
79	1 440	14	640	282	254	178	407	2 125	50-59 years
46	802	4	202	51	190	61	122	347	Less than upper secondary (L)
16	416	6	263	199	21	50	168	933	Upper secondary level (M)
17	194	4	172	32	22	66	115	531	Third level (H)
0	28	1	3	0	21	0	1	314	Non responses
582	8 727	96	3 749	1 755	1 817	990	1 690	11 933	All Employees aged 15-59 years
234	4 430	30	1 197	311	1 349	228	345	1 101	Less than upper secondary (L)
182	3 367	44	1 656	1 293	231	457	858	6 473	Upper secondary level (M)
164	857	19	886	150	152	303	482	3 222	Third level (H)
1	72	4	10	0	85	2	5	1 137	Non responses
Females									
109	613	7	562	229	274	133	169	1 744	15-24 years
21	234	2	237	69	187	39	45	109	Less than upper secondary (L)
54	363	3	279	156	61	79	97	1 292	Upper secondary level (M)
34	14	(1)	47	4	24	15	26	280	Third level (H)
0	2	0	0	0	3	0	2	63	Non responses
320	4 364	49	1 971	1 002	1 074	635	1 111	7 075	25-49 years
82	1 388	14	473	206	697	90	134	777	Less than upper secondary (L)
119	2 248	22	955	685	167	253	570	3 674	Upper secondary level (M)
118	711	10	539	111	183	291	406	2 111	Third level (H)
1	16	2	4	0	27	0	1	513	Non responses
44	741	7	354	165	193	211	435	2 017	50-59 years
19	352	3	151	50	127	74	102	544	Less than upper secondary (L)
12	240	2	121	101	10	65	197	747	Upper secondary level (M)
13	131	2	80	14	24	71	135	423	Third level (H)
0	18	0	1	0	32	1	1	303	Non responses
473	5 718	62	2 887	1 395	1 541	979	1 714	10 836	All Employees aged 15-59 years
122	1 974	19	862	325	1 011	203	281	1 430	Less than upper secondary (L)
185	2 850	28	1 354	942	238	397	864	5 713	Upper secondary level (M)
165	857	12	666	128	230	377	566	2 814	Third level (H)
1	37	2	5	0	63	1	3	879	Non responses

(1) 1998.

(2) 1997.

(3) Greece 1998, Ireland 1997.

(4) Ireland 1997.

Table 26

Employees by economic activity

Thousands

	EU-15 ⁽²⁾	EUR-11	B	DK	D	EL ⁽¹⁾	E	F
Males and Females								
Agriculture (A-B)	2 298	1 987	25	47	556	29	402	288
Industry (C-F)	39 873	31 506	917	665	11 431	641	3 576	5 415
Mining and quarrying (C)	525	396	10	(4)	172	17	61	47
Manufacturing (D)	28 927	22 709	697	483	8 188	410	2 296	4 032
Electricity, gaz, water supply (E)	1 178	913	29	19	312	35	90	187
Construction (F)	9 243	7 487	181	160	2 760	179	1 129	1 150
Services (G-Q)	87 496	64 086	2 357	1 735	20 206	1 575	6 793	14 280
Wholesale and retail, repairs (G)	17 412	12 657	388	330	4 431	293	1 451	2 533
Hotels and restaurants (H)	4 459	3 169	65	53	887	129	557	556
Transports, communications (I)	8 219	6 047	290	164	1 810	175	594	1 390
Financial intermediation (J)	4 878	3 502	145	84	1 170	91	334	687
Real estate, business activit. (K)	10 057	7 033	212	198	2 138	87	723	1 838
Public administration (L)	11 616	9 373	364	156	2 996	278	884	2 068
Other services (M-Q)	30 856	22 305	892	750	6 775	522	2 250	5 208
Non responses	348	313	0	9	0	0	0	6
All Employees	130 016	97 893	3 299	2 457	32 193	2 245	10 771	19 989
Males								
Agriculture (A-B)	1 613	1 378	19	38	351	20	310	210
Industry (C-F)	30 437	24 035	743	487	8 631	506	2 980	4 061
Mining and quarrying (C)	469	357	10	(3)	162	17	54	40
Manufacturing (D)	20 635	16 112	543	327	5 834	283	1 763	2 830
Electricity, gaz, water supply (E)	949	750	24	16	246	29	79	142
Construction (F)	8 384	6 816	165	141	2 389	178	1 083	1 049
Services (G-Q)	40 053	29 703	1 124	755	8 717	856	3 400	6 443
Wholesale and retail, repairs (G)	8 746	6 394	194	186	1 950	171	806	1 375
Hotels and restaurants (H)	1 898	1 398	29	15	329	71	281	287
Transports, communications (I)	6 048	4 441	228	118	1 270	146	458	990
Financial intermediation (J)	2 466	1 813	83	46	531	48	220	306
Real estate, business activit. (K)	5 093	3 442	108	108	979	37	350	944
Public administration (L)	6 794	5 534	205	85	1 690	185	549	1 091
Other services (M-Q)	9 009	6 682	277	197	1 968	198	736	1 449
Non responses	161	139	0	4	0	0	0	4
All Employees	72 263	55 254	1 886	1 284	17 698	1 383	6 690	10 718
Females								
Agriculture (A-B)	685	610	5	10	206	9	93	78
Industry (C-F)	9 437	7 471	174	178	2 800	135	596	1 354
Mining and quarrying (C)	56	40	.	.	10	.	6	(7)
Manufacturing (D)	8 292	6 597	153	156	2 353	127	533	1 202
Electricity, gaz, water supply (E)	229	164	(4)	.	66	6	11	44
Construction (F)	860	671	16	18	371	.	46	101
Services (G-Q)	47 444	34 383	1 233	980	11 489	718	3 393	7 836
Wholesale and retail, repairs (G)	8 666	6 263	194	144	2 481	122	644	1 158
Hotels and restaurants (H)	2 561	1 772	36	38	558	58	276	269
Transports, communications (I)	2 171	1 607	62	46	540	28	136	400
Financial intermediation (J)	2 412	1 689	62	37	638	43	114	381
Real estate, business activit. (K)	4 964	3 591	104	91	1 159	50	373	894
Public administration (L)	4 822	3 839	159	71	1 306	93	335	976
Other services (M-Q)	21 847	15 623	615	553	4 807	324	1 515	3 759
Non responses	187	174	0	5	0	0	0	2
All Employees	57 752	42 638	1 412	1 173	14 494	862	4 082	9 270

⁽¹⁾ 1998.⁽²⁾ Greece 1998.

Table 26

Employees by economic activity

Thousands

IRL	I	L	NL	A	P	FIN	S	UK	
Males and Females									
27	423	(1)	100	32	91	42	31	204	Agriculture (A-B)
390	5 207	36	1 496	1 033	1 420	585	921	6 139	Industry (C-F)
5	64	.	11	9	13	(4)	.	99	Mining and quarrying (C)
268	4 019	21	1 051	711	986	441	711	4 614	Manufacturing (D)
11	160	(1)	39	33	31	21	29	182	Electricity, gaz,water supply (E)
105	964	14	396	279	389	120	173	1 244	Construction (F)
859	9 151	122	4 842	2 110	1 988	1 378	2 635	17 466	Services (G-Q)
182	1 486	19	992	519	416	239	432	3 700	Wholesale and retail,repairs (G)
84	399	5	212	161	174	68	88	1 020	Hotels and restaurants (H)
79	931	13	422	234	139	147	242	1 591	Transports, communications (I)
58	567	18	260	141	77	45	84	1 118	Financial intermediation (J)
107	729	11	734	199	158	184	351	2 387	Real estate,business activit. (K)
74	1 797	16	539	221	296	118	201	1 608	Public administration (L)
275	3 243	41	1 682	634	729	577	1 238	6 042	Other services (M-Q)
8	0	1	292	0	0	6	3	23	Non responses
1 284	14 782	160	6 730	3 175	3 499	2 011	3 589	23 832	All Employees
Males									
23	289	(1)	66	20	61	28	23	155	Agriculture (A-B)
297	3 863	32	1 227	817	946	439	710	4 698	Industry (C-F)
5	56	.	(8)	7	12	(3)	.	86	Mining and quarrying (C)
182	2 763	17	817	523	531	307	527	3 387	Manufacturing (D)
10	141	(1)	32	29	28	17	22	132	Electricity, gaz,water supply (E)
100	902	13	370	258	374	112	155	1 093	Construction (F)
378	4 819	64	2 395	933	892	538	1 047	7 692	Services (G-Q)
87	848	10	536	222	247	117	233	1 762	Wholesale and retail,repairs (G)
32	206	3	97	53	61	20	31	383	Hotels and restaurants (H)
57	731	10	309	182	105	102	173	1 170	Transports, communications (I)
24	358	11	143	70	53	14	36	523	Financial intermediation (J)
52	327	6	428	83	68	96	204	1 302	Real estate,business activit. (K)
45	1 189	11	370	135	191	57	104	885	Public administration (L)
81	1 158	14	510	189	168	131	265	1 667	Other services (M-Q)
4	0	0	127	0	0	4	2	17	Non responses
701	8 971	97	3 814	1 771	1 900	1 008	1 782	12 561	All Employees
Females									
(4)	134	.	34	12	30	14	.	49	Agriculture (A-B)
94	1 345	4	269	215	474	146	211	1 442	Industry (C-F)
.	9	13	Mining and quarrying (C)
87	1 256	3	233	188	455	134	185	1 227	Manufacturing (D)
.	18	.	(7)	4	(3)	(4)	.	51	Electricity, gaz,water supply (E)
5	62	(1)	26	21	15	8	18	152	Construction (F)
482	4 332	58	2 447	1 177	1 096	840	1 588	9 774	Services (G-Q)
95	637	9	456	297	169	122	199	1 939	Wholesale and retail,repairs (G)
53	193	2	115	109	113	48	57	636	Hotels and restaurants (H)
22	199	3	113	52	34	45	68	421	Transports, communications (I)
34	209	7	117	71	24	32	48	595	Financial intermediation (J)
55	402	5	306	116	90	88	147	1 085	Real estate,business activit. (K)
29	607	5	169	86	105	61	97	723	Public administration (L)
194	2 084	27	1 172	445	561	445	972	4 375	Other services (M-Q)
4	0	0	165	0	0	3	1	7	Non responses
584	5 811	63	2 916	1 404	1 600	1 003	1 807	11 272	All Employees

(1) 1998.

(2) Greece 1998.

Table 27

Employees by occupation

Thousands

	EU-15 ⁽²⁾	EUR-11 ⁽⁴⁾	B	DK	D	EL ⁽¹⁾	E	F
Males and Females								
Legislators and managers (1)	7 333	3 643	196	125	1 057	57	221	900
Professionals (2)	16 923	11 934	671	321	3 832	357	1 379	2 080
Technicians (3)	19 873	16 406	377	483	6 592	238	1 065	3 792
Clerks (4)	19 783	14 360	587	324	4 506	354	1 280	3 164
Services and sales workers (5)	17 891	12 560	339	400	3 888	336	1 641	2 716
Agriculture/ fishery workers (6)	1 451	1 252	29	33	419	16	152	319
Craft/related trades workers (7)	19 344	15 914	376	264	5 909	398	1 867	2 548
Plant and machine operators (8)	12 429	9 633	345	186	2 603	234	1 199	2 352
Elementary occupations (9)	12 475	9 891	333	299	2 730	211	1 901	1 805
Armed forces (0)	1 106	907	38	17	218	44	66	280
Non responses	1 211	1 196	6	3	441	0	0	35
All Employees	129 819	97 696	3 299	2 457	32 193	2 245	10 771	19 989
Males								
Legislators and managers (1)	5 198	2 723	138	98	817	42	187	607
Professionals (2)	8 985	6 409	293	195	2 366	179	672	1 271
Technicians (3)	9 577	7 850	256	207	2 633	125	647	1 868
Clerks (4)	6 422	4 863	228	96	1 419	158	523	753
Services and sales workers (5)	5 680	4 107	105	84	941	181	729	737
Agriculture/ fishery workers (6)	1 083	918	23	27	247	12	135	260
Craft/related trades workers (7)	17 244	14 116	346	251	5 328	349	1 724	2 353
Plant and machine operators (8)	10 194	7 877	290	142	2 197	198	1 004	1 867
Elementary occupations (9)	6 048	4 752	168	166	1 277	100	1 004	714
Armed forces (0)	1 053	871	35	15	214	38	65	258
Non responses	682	673	4	2	259	0	0	30
All Employees	72 166	55 158	1 886	1 284	17 698	1 383	6 690	10 718
Females								
Legislators and managers (1)	2 135	920	58	27	239	15	34	292
Professionals (2)	7 938	5 526	379	125	1 466	178	707	808
Technicians (3)	10 297	8 556	121	276	3 959	113	419	1 924
Clerks (4)	13 360	9 498	359	228	3 087	195	757	2 410
Services and sales workers (5)	12 211	8 453	235	316	2 946	155	912	1 979
Agriculture/ fishery workers (6)	368	334	6	6	172	(4)	17	59
Craft/related trades workers (7)	2 100	1 798	30	13	581	49	143	194
Plant and machine operators (8)	2 235	1 756	55	46	406	36	195	485
Elementary occupations (9)	6 428	5 139	165	133	1 452	111	897	1 091
Armed forces (0)	.	37	(4)	.	.	6	.	22
Non responses	529	523	2	1	182	0	0	5
All Employees	57 652	42 538	1 412	1 173	14 494	862	4 082	9 270

⁽¹⁾ 1998.⁽²⁾ 1997.⁽³⁾ Greece 1998, Ireland 1997.⁽⁴⁾ Ireland 1997.

Table 27

Employees by occupation

Thousands

IRL ⁽²⁾	I	L	NL	A	P	FIN	S	UK	
Males and Females									
97	291	6	527	170	51	128	142	3 366	Legislators and managers (1)
210	1 559	25	1 185	305	288	399	579	3 732	Professionals (2)
40	2 206	31	1 207	454	299	343	737	2 009	Technicians (3)
184	2 594	27	889	505	429	197	414	4 330	Clerks (4)
201	1 641	15	864	453	539	265	688	3 907	Services and sales workers (5)
(4)	106	2	97	20	68	37	32	119	Agriculture/ fishery workers (6)
145	2 545	23	707	615	910	268	379	2 390	Craft/related trades workers (7)
101	1 686	13	472	313	367	182	400	1 975	Plant and machine operators (8)
104	1 416	18	558	339	514	174	202	1 873	Elementary occupations (9)
.	212	.	45	.	36	11	13	125	Armed forces (0)
2	525	0	178	0	0	8	4	8	Non responses
1 088	14 782	160	6 730	3 175	3 499	2 011	3 589	23 832	All Employees
Males									
69	244	4	412	120	36	88	102	2 233	Legislators and managers (1)
101	582	15	665	147	129	168	271	1 931	Professionals (2)
26	1 277	18	584	239	152	152	374	1 020	Technicians (3)
53	1 197	13	295	172	169	40	119	1 187	Clerks (4)
72	833	6	280	140	198	67	130	1 178	Services and sales workers (5)
(4)	87	2	74	14	50	22	23	103	Agriculture/ fishery workers (6)
112	2 125	22	662	556	647	239	355	2 174	Craft/related trades workers (7)
87	1 322	12	412	260	280	146	327	1 650	Plant and machine operators (8)
78	818	6	289	122	203	72	65	965	Elementary occupations (9)
.	212	.	41	.	34	11	13	117	Armed forces (0)
1	275	0	99	0	0	5	3	4	Non responses
604	8 971	97	3 814	1 771	1 900	1 008	1 782	12 561	All Employees
Females									
28	47	(1)	116	50	15	40	39	1 134	Legislators and managers (1)
109	978	10	520	158	159	231	308	1 801	Professionals (2)
14	929	14	623	216	147	191	363	989	Technicians (3)
131	1 397	15	593	332	260	157	295	3 143	Clerks (4)
128	808	9	583	313	341	198	558	2 729	Services and sales workers (5)
.	19	.	22	6	17	15	9	15	Agriculture/ fishery workers (6)
33	420	(1)	45	58	262	29	24	216	Craft/related trades workers (7)
14	364	(1)	60	53	87	36	73	325	Plant and machine operators (8)
26	598	12	269	216	311	102	136	908	Elementary occupations (9)
.	Armed forces (0)
1	251	0	79	0	0	3	1	4	Non responses
484	5 811	63	2 916	1 404	1 600	1 003	1 807	11 272	All Employees

(1) 1998.

(2) 1997.

(3) Greece 1998, Ireland 1997.

(4) Ireland 1997.

EMPLOYMENT

Temporary employees

Table 28⁽¹⁾

Temporary employees as percent of the total employees, by age group

Percentages of the Male and/or Female Employees

	EU-15 ⁽³⁾	EUR-11 ⁽⁴⁾	B	DK	D	EL ⁽²⁾	E	F
Males and Females								
15-24 years	5.0	5.8	3.4	4.7	6.6	3.1	10.3	5.1
25-49 years	7.0	7.9	6.3	4.4	5.6	8.5	19.9	8.0
50-64 years	1.1	1.1	0.6	1.0	0.9	1.4	2.5	0.9
65 & + years	0.1	0.0	0.1	.
15-64 years	13.1	14.8	10.2	10.1	13.1	13.0	32.7	14.0
All ages	13.2	14.8	10.3	10.2	13.1	13.0	32.7	14.0
Males								
15-24 years	5.0	5.7	2.8	5.1	6.6	3.0	9.8	5.5
25-49 years	6.3	7.1	4.3	3.2	5.3	7.4	18.7	7.1
50-64 years	1.1	1.1	0.5	0.9	0.9	1.5	2.8	0.7
65 & + years	0.1
15-64 years	12.3	13.9	7.6	9.1	12.8	11.9	31.3	13.3
All ages	12.4	14.0	7.7	9.2	12.8	12.0	31.4	13.3
Females								
15-24 years	5.0	5.9	4.1	4.4	6.6	3.3	11.0	4.7
25-49 years	7.9	8.8	8.9	5.7	5.9	10.2	21.7	9.1
50-64 years	1.2	1.1	0.7	1.1	0.9	1.1	2.1	1.1
65 & + years	(0.1)	.
15-64 years	14.1	15.9	13.7	11.2	13.4	14.7	34.8	14.8
All ages	14.2	15.9	13.7	11.3	13.4	14.7	34.9	14.8

⁽¹⁾ These percentages were calculated in the same way as the percentages of the NEWCRONOS table *etp_ga*. Non responses to the variable CONTRACTUAL DURATION OF JOB not considered.

⁽²⁾ 1998.

⁽³⁾ Greece 1998, Ireland 1998.

⁽⁴⁾ Ireland 1998.

(1) Table 28
Temporary employees as percent of the total employees, by age group
Percentages of the Male and/or Female Employees

IRL ⁽²⁾	I	L	NL	A	P	FIN	S	UK	
Males and Females									
3.7	2.6	1.6	5.6	4.8	6.9	7.1	4.0	1.9	15-24 years
3.3	6.2	1.6	5.1	2.5	10.2	9.5	8.0	3.6	25-49 years
0.6	0.9	.	1.1	0.2	1.3	1.6	1.7	1.1	50-64 years
.	(0.0)	.	(0.1)	.	0.2	.	.	0.2	65 & + years
7.7	9.8	3.4	11.9	7.5	18.4	18.1	13.7	6.6	15-64 years
7.7	9.8	3.4	12.0	7.5	18.6	18.2	13.9	6.8	All ages
Males									
3.2	2.3	1.7	5.1	5.1	6.6	6.7	3.5	1.9	15-24 years
2.2	5.1	(1.0)	3.4	1.9	9.0	7.4	6.0	3.0	25-49 years
(0.5)	1.0	.	0.7	0.2	1.3	1.1	1.4	1.1	50-64 years
.	.	.	(0.2)	.	(0.2)	.	.	0.2	65 & + years
5.9	8.4	2.8	9.2	7.3	16.9	15.1	10.9	5.9	15-64 years
5.9	8.5	2.8	9.4	7.3	17.1	15.2	11.2	6.2	All ages
Females									
4.4	3.0	(1.6)	6.4	4.3	7.2	7.5	4.5	1.9	15-24 years
4.6	7.9	2.4	7.4	3.2	11.7	11.6	10.0	4.2	25-49 years
(0.9)	0.9	.	1.6	0.3	1.3	2.1	2.0	1.2	50-64 years
.	(0.2)	.	.	0.2	65 & + years
9.8	11.8	4.3	15.3	7.8	20.2	21.2	16.5	7.3	15-64 years
9.9	11.8	4.4	15.4	7.8	20.4	21.2	16.6	7.5	All ages

⁽¹⁾ These percentages were calculated in the same way as the percentages of the NEWCRONOS table *ep_ga*. Non responses to the variable CONTRACTUAL DURATION OF JOB not considered.

⁽²⁾ 1998.

⁽³⁾ Greece 1998, Ireland 1998.

⁽⁴⁾ Ireland 1998.

Table 29

Temporary employees by age group and educational attainment level

Thousands

	EU-15 ⁽³⁾	EUR-11 ⁽⁴⁾	B	DK	D	EL ⁽¹⁾	E	F
Males and Females								
15-24 years	6 453	5 678	112	117	2 098	70	1 109	1 017
Less than upper secondary (L)	3 228	3 053	41	67	1 340	25	625	348
Upper secondary level (M)	2 496	2 029	44	48	659	41	263	494
Third level (H)	641	527	26	.	35	(4)	220	176
Non responses	89	70	0	0	66	0	0	0
25-49 years	9 089	7 667	207	108	1 777	190	2 138	1 596
Less than upper secondary (L)	3 104	2 883	59	25	265	86	1 223	512
Upper secondary level (M)	3 206	2 627	68	51	904	58	334	642
Third level (H)	2 625	2 078	80	32	563	45	582	443
Non responses	154	78	0	0	46	0	0	0
50-59 years	1 230	931	14	19	261	26	235	164
Less than upper secondary (L)	580	515	8	5	43	21	217	86
Upper secondary level (M)	368	254	(3)	11	132	(3)	9	54
Third level (H)	231	129	(3)	(4)	71	.	10	24
Non responses	52	33	0	0	14	0	0	0
All temp. employees aged 15-59	16 772	14 275	333	244	4 136	286	3 482	2 778
Less than upper secondary (L)	6 912	6 451	109	97	1 648	132	2 065	946
Upper secondary level (M)	6 069	4 910	115	111	1 695	102	605	1 189
Third level (H)	3 497	2 734	109	36	669	51	812	642
Non responses	294	180	0	0	125	0	0	0
Males								
15-24 years	3 563	3 160	53	65	1 156	42	659	586
Less than upper secondary (L)	1 986	1 878	24	47	780	20	420	238
Upper secondary level (M)	1 267	1 034	21	19	329	21	140	276
Third level (H)	264	209	9	.	10	.	99	72
Non responses	46	39	0	0	37	0	0	0
25-49 years	4 534	3 916	82	41	934	102	1 251	760
Less than upper secondary (L)	1 782	1 677	27	11	138	49	815	263
Upper secondary level (M)	1 542	1 291	27	17	474	33	178	322
Third level (H)	1 126	901	28	12	297	20	259	176
Non responses	84	46	0	0	26	0	0	0
50-59 years	646	505	6	9	142	17	162	67
Less than upper secondary (L)	322	289	(3)	.	19	13	152	36
Upper secondary level (M)	176	123	.	(4)	69	.	(4)	22
Third level (H)	119	72	.	.	45	.	6	9
Non responses	30	20	0	0	9	0	0	0
All temp. employees aged 15-59	8 743	7 581	141	115	2 232	161	2 072	1 413
Less than upper secondary (L)	4 090	3 845	53	60	937	82	1 387	537
Upper secondary level (M)	2 984	2 448	49	40	872	56	322	620
Third level (H)	1 509	1 183	38	15	352	22	363	257
Non responses	160	105	0	0	71	0	0	0
Females								
15-24 years	2 891	2 517	59	51	942	28	450	432
Less than upper secondary (L)	1 242	1 175	18	21	560	5	205	110
Upper secondary level (M)	1 229	994	23	30	329	20	123	218
Third level (H)	377	317	17	.	24	(3)	122	104
Non responses	43	31	0	0	29	0	0	0
25-49 years	4 555	3 750	125	67	844	88	887	836
Less than upper secondary (L)	1 322	1 206	32	14	128	37	408	249
Upper secondary level (M)	1 664	1 336	41	34	430	25	156	320
Third level (H)	1 500	1 177	52	19	266	25	323	267
Non responses	70	32	0	0	20	0	0	0
50-59 years	584	426	9	11	119	9	73	97
Less than upper secondary (L)	259	225	6	.	24	7	65	51
Upper secondary level (M)	192	131	.	7	63	.	(4)	31
Third level (H)	112	57	.	.	26	.	(4)	14
Non responses	21	12	0	0	5	0	0	0
All temp. employees aged 15-59	8 030	6 694	192	129	1 904	125	1 410	1 365
Less than upper secondary (L)	2 823	2 606	56	37	712	50	678	410
Upper secondary level (M)	3 084	2 461	66	71	823	46	283	570
Third level (H)	1 988	1 551	71	21	316	29	449	385
Non responses	134	75	0	0	54	0	0	0

⁽¹⁾ 1998.⁽²⁾ 1997.⁽³⁾ Greece 1998, Ireland 1997.⁽⁴⁾ Ireland 1997.

Table 29

Temporary employees by age group and educational attainment level

Thousands

IRL ⁽²⁾	I	L	NL	A	P	FIN	S	UK	
Males and Females									
40	385	3	379	152	241	142	142	447	15-24 years
13	147	(1)	203	120	167	48	46	37	Less than upper secondary (L)
18	225	(1)	158	31	52	85	76	301	Upper secondary level (M)
10	12	.	18	.	19	9	18	91	Third level (H)
0	1	0	0	0	3	0	1	18	Non responses
51	919	3	346	80	358	190	285	840	25-49 years
23	405	(1)	121	14	237	24	50	59	Less than upper secondary (L)
12	345	(1)	145	43	48	85	134	335	Upper secondary level (M)
16	159	(1)	78	22	53	81	101	369	Third level (H)
0	10	0	2	0	20	0	0	76	Non responses
8	120	.	55	7	36	30	49	205	50-59 years
6	92	.	27	.	23	11	15	25	Less than upper secondary (L)
.	16	.	19	5	.	12	23	77	Upper secondary level (M)
.	(4)	.	(9)	.	.	7	12	84	Third level (H)
0	9	0	0	0	10	0	0	19	Non responses
100	1 424	5	780	238	635	363	476	1 492	All temp. employees aged 15-59
42	644	2	350	135	427	83	111	121	Less than upper secondary (L)
31	586	2	323	79	102	182	233	714	Upper secondary level (M)
27	175	(1)	105	24	73	97	131	544	Third level (H)
0	19	0	2	0	33	1	1	113	Non responses
Males									
17	210	2	194	91	125	67	62	233	15-24 years
7	95	(1)	115	76	98	25	22	19	Less than upper secondary (L)
7	110	(1)	73	15	22	41	33	159	Upper secondary level (M)
(3)	(4)	.	(6)	.	(4)	.	.	48	Third level (H)
0	0	0	0	0	1	0	1	7	Non responses
20	458	(1)	130	35	171	74	107	369	25-49 years
12	246	.	42	5	119	12	18	26	Less than upper secondary (L)
(3)	152	.	57	20	22	37	48	153	Upper secondary level (M)
5	55	.	30	9	17	25	41	152	Third level (H)
0	6	0	1	0	13	0	0	37	Non responses
(4)	72	.	18	3	20	10	19	97	50-59 years
(4)	54	.	(5)	.	13	(3)	.	.	Less than upper secondary (L)
.	10	.	(8)	.	.	(4)	.	39	Upper secondary level (M)
.	.	.	(5)	.	.	(3)	.	38	Third level (H)
0	6	0	0	0	5	0	0	10	Non responses
42	740	3	341	129	317	152	187	699	All temp. employees aged 15-59
22	394	(1)	162	82	230	41	46	56	Less than upper secondary (L)
11	272	(1)	137	37	45	81	88	351	Upper secondary level (M)
9	61	.	41	10	22	30	51	238	Third level (H)
0	12	0	2	0	20	0	1	54	Non responses
Females									
23	175	(1)	185	61	115	75	80	214	15-24 years
6	52	.	88	44	69	23	24	18	Less than upper secondary (L)
10	115	.	85	16	30	44	43	142	Upper secondary level (M)
6	8	.	12	.	15	8	13	43	Third level (H)
0	1	0	0	0	1	0	0	12	Non responses
31	461	2	216	45	187	116	179	471	25-49 years
12	160	.	79	9	118	12	32	33	Less than upper secondary (L)
9	193	(1)	89	23	26	49	86	182	Upper secondary level (M)
11	104	.	48	13	36	56	61	218	Third level (H)
0	4	0	0	0	7	0	0	38	Non responses
(4)	48	.	37	4	16	20	30	109	50-59 years
.	38	.	21	.	10	8	.	15	Less than upper secondary (L)
.	(6)	.	12	3	.	8	15	38	Upper secondary level (M)
.	(4)	.	46	Third level (H)
0	2	0	0	0	5	0	0	9	Non responses
58	684	3	439	110	318	211	289	794	All temp. employees aged 15-59
20	250	(1)	188	53	197	42	64	66	Less than upper secondary (L)
20	313	(1)	186	42	56	101	144	362	Upper secondary level (M)
18	114	(1)	65	14	52	68	80	307	Third level (H)
0	7	0	0	0	13	0	0	59	Non responses

(1) 1998.

(2) 1997.

(3) Greece 1998, Ireland 1997.

(4) Ireland 1997.

Table 30

Temporary employees by economic activity

Thousands

	EU-15 ⁽²⁾	EUR-11 ⁽³⁾	B	DK	D	EL ⁽¹⁾	E	F
Males and Females								
Agriculture (A-B)	721	668	5	12	130	16	247	61
Industry (C-F)	4 805	4 302	65	58	1 252	90	1 372	701
Mining and quarrying (C)	.	35	.	.	14	.	13	.
Manufacturing (D)	2 874	2 568	52	34	791	36	652	502
Electricity, gaz, water supply (E)	95	79	.	.	33	.	13	14
Construction (F)	1 793	1 620	9	23	414	52	694	184
Services (G-Q)	11 366	9 286	270	179	2 786	187	1 906	2 023
Wholesale and retail, repairs (G)	2 022	1 781	26	30	535	30	475	309
Hotels and restaurants (H)	937	765	12	6	151	44	252	104
Transports, communications (I)	692	562	10	9	139	12	141	128
Financial intermediation (J)	324	249	8	(3)	99	.	41	44
Real estate, business activit. (K)	1 243	1 005	25	14	255	10	223	245
Public administration (L)	1 324	1 178	46	17	432	10	144	298
Other services (M-Q)	4 823	3 747	142	100	1 176	77	629	894
Non responses	166	162	0	1	0	0	0	2
All in temporary employment	17 057	14 418	339	250	4 168	292	3 524	2 787
Males								
Agriculture (A-B)	451	417	(3)	8	73	10	177	36
Industry (C-F)	3 734	3 344	49	44	967	76	1 149	521
Mining and quarrying (C)	.	31	.	.	12	.	11	.
Manufacturing (D)	1 934	1 722	38	23	558	22	449	341
Electricity, gaz, water supply (E)	69	58	.	.	25	.	10	(7)
Construction (F)	1 695	1 533	9	20	372	52	678	173
Services (G-Q)	4 663	3 844	93	65	1 213	79	773	859
Wholesale and retail, repairs (G)	960	847	9	14	266	15	215	148
Hotels and restaurants (H)	392	325	5	.	58	22	110	56
Transports, communications (I)	463	369	7	7	83	10	102	80
Financial intermediation (J)	130	98	5	.	46	.	13	16
Real estate, business activit. (K)	579	462	12	(4)	109	(3)	100	128
Public administration (L)	724	651	18	8	270	7	80	149
Other services (M-Q)	1 415	1 092	38	29	380	22	153	281
Non responses	75	73	0	1	0	0	0	2
All in temporary employment	8 924	7 679	146	118	2 254	165	2 099	1 418
Females								
Agriculture (A-B)	270	251	.	(4)	57	5	69	24
Industry (C-F)	1 070	958	15	13	284	14	223	180
Mining and quarrying (C)
Manufacturing (D)	940	845	15	11	233	13	203	161
Electricity, gaz, water supply (E)	(3)	(6)
Construction (F)	98	88	.	(3)	42	.	16	12
Services (G-Q)	6 703	5 442	177	114	1 573	108	1 133	1 165
Wholesale and retail, repairs (G)	1 063	933	17	15	269	15	260	161
Hotels and restaurants (H)	545	440	7	5	93	22	142	48
Transports, communications (I)	229	193	(3)	.	55	.	40	49
Financial intermediation (J)	194	151	(4)	.	53	.	28	28
Real estate, business activit. (K)	664	543	14	10	146	7	122	118
Public administration (L)	600	526	28	9	162	(3)	64	149
Other services (M-Q)	3 408	2 655	105	71	796	56	477	613
Non responses	91	89	0	1	0	0	0	0
All in temporary employment	8 134	6 740	193	132	1 914	127	1 425	1 369

⁽¹⁾ 1998.⁽²⁾ Greece 1998. Ireland 1998.⁽³⁾ Ireland 1998.

Table 30

Temporary employees by economic activity

Thousands									
IRL ⁽¹⁾	I	L	NL	A	P	FIN	S	UK	
Males and Females									
.	155	.	22	4	29	13	.	20	Agriculture (A-B)
20	394	(1)	114	80	227	77	70	285	Industry (C-F)
.	Mining and quarrying (C)
13	251	.	92	45	119	51	51	186	Manufacturing (D)
.	8	.	.	2	(4)	.	.	13	Electricity, gaz,water supply (E)
7	134	.	19	32	102	24	18	81	Construction (F)
63	897	5	512	155	396	273	419	1 295	Services (G-Q)
12	150	(1)	111	45	82	34	53	129	Wholesale and retail,repairs (G)
11	77	.	61	25	59	13	23	98	Hotels and restaurants (H)
(3)	58	.	33	9	24	16	25	84	Transports, communications (I)
(3)	19	.	16	6	8	(3)	.	63	Financial intermediation (J)
7	91	.	78	11	42	27	45	169	Real estate,business activit. (K)
.	164	(1)	31	7	35	18	23	97	Public administration (L)
26	337	2	180	53	147	162	244	655	Other services (M-Q)
1	0	0	158	0	0	2	0	2	Non responses
87	1 447	5	805	239	653	365	495	1 602	All in temporary employment
Males									
.	89	.	11	.	17	7	.	12	Agriculture (A-B)
15	287	(1)	72	66	159	58	51	219	Industry (C-F)
.	Mining and quarrying (C)
7	152	.	53	33	56	34	34	133	Manufacturing (D)
.	(7)	.	.	.	(3)	.	.	.	Electricity, gaz,water supply (E)
7	126	.	17	31	98	23	16	74	Construction (F)
20	383	2	205	62	149	86	143	532	Services (G-Q)
5	77	.	55	20	39	11	23	61	Wholesale and retail,repairs (G)
(4)	34	.	28	9	18	(3)	.	36	Hotels and restaurants (H)
.	41	.	19	7	18	10	18	59	Transports, communications (I)
.	(6)	.	(5)	3	(3)	.	.	27	Financial intermediation (J)
.	37	.	40	4	17	13	21	89	Real estate,business activit. (K)
.	84	.	16	4	22	8	10	48	Public administration (L)
6	104	.	42	15	33	40	60	213	Other services (M-Q)
0	0	0	70	0	0	1	0	1	Non responses
37	759	3	357	129	326	153	198	764	All in temporary employment
Females									
.	66	.	12	3	11	6	.	.	Agriculture (A-B)
6	108	.	42	14	68	18	19	67	Industry (C-F)
.	Mining and quarrying (C)
5	98	.	39	12	63	17	17	54	Manufacturing (D)
.	Electricity, gaz,water supply (E)
.	8	.	.	.	(4)	.	.	.	Construction (F)
43	514	3	307	93	247	187	276	763	Services (G-Q)
7	73	.	56	25	44	22	30	68	Wholesale and retail,repairs (G)
7	43	.	34	16	41	11	15	62	Hotels and restaurants (H)
.	17	.	14	2	6	6	.	25	Transports, communications (I)
.	13	.	12	3	5	.	.	36	Financial intermediation (J)
5	55	.	39	6	25	14	24	80	Real estate,business activit. (K)
.	80	.	15	3	13	10	12	49	Public administration (L)
20	233	2	138	38	113	121	184	442	Other services (M-Q)
0	0	0	87	0	0	1	0	1	Non responses
50	688	3	448	110	327	212	297	838	All in temporary employment

⁽¹⁾ 1998.

⁽²⁾ Greece 1998, Ireland 1998.

⁽³⁾ Ireland 1998.

Table 31

Temporary employees by occupation

Thousands

	EU-15 ⁽³⁾	EUR-11 ⁽⁴⁾	B	DK	D	EL ⁽¹⁾	E	F
Males and Females								
Legislators and managers (1)	232	147	9	(3)	52	.	15	30
Professionals (2)	2 123	1 567	78	23	482	35	304	271
Technicians (3)	2 041	1 805	30	28	776	21	215	405
Clerks (4)	2 136	1 713	57	39	506	22	288	404
Services and sales workers (5)	2 744	2 182	44	62	504	57	569	441
Agriculture/ fishery workers (6)	397	362	6	10	122	7	60	83
Craft/related trades workers (7)	2 916	2 659	31	43	889	67	762	427
Plant and machine operators (8)	1 313	1 148	24	5	194	22	353	337
Elementary occupations (9)	2 629	2 317	57	33	312	58	945	341
Armed forces (0)	212	203	.	(3)	139	.	13	34
Non responses	331	330	0	0	192	0	0	14
All in temporary employment	17 072	14 433	339	250	4 168	292	3 524	2 787
Males								
Legislators and managers (1)	142	94	5	.	38	.	12	13
Professionals (2)	927	681	23	12	254	12	125	126
Technicians (3)	818	718	18	10	251	12	109	178
Clerks (4)	631	486	19	13	167	7	77	77
Services and sales workers (5)	745	607	8	12	110	25	183	120
Agriculture/ fishery workers (6)	251	227	(4)	6	61	5	50	59
Craft/related trades workers (7)	2 608	2 365	28	41	796	61	695	392
Plant and machine operators (8)	1 004	875	17	(3)	159	16	269	255
Elementary occupations (9)	1 421	1 254	22	17	166	22	567	156
Armed forces (0)	199	193	.	.	135	.	13	29
Non responses	185	185	0	0	117	0	0	12
All in temporary employment	8 930	7 685	146	118	2 254	165	2 099	1 418
Females								
Legislators and managers (1)	91	53	(4)	.	14	.	(3)	17
Professionals (2)	1 195	886	55	11	228	23	179	145
Technicians (3)	1 224	1 087	12	19	525	9	106	227
Clerks (4)	1 504	1 226	38	26	339	14	211	328
Services and sales workers (5)	1 999	1 575	36	50	394	32	386	321
Agriculture/ fishery workers (6)	146	135	.	(4)	61	.	11	24
Craft/related trades workers (7)	308	294	(3)	.	93	6	67	35
Plant and machine operators (8)	308	273	6	.	35	6	84	81
Elementary occupations (9)	1 207	1 067	36	16	146	35	379	184
Armed forces (0)	(5)
Non responses	146	146	0	0	75	0	0	2
All in temporary employment	8 143	6 748	193	132	1 914	127	1 425	1 369

⁽¹⁾ 1998.⁽²⁾ 1997.⁽³⁾ Greece 1998, Ireland 1997.⁽⁴⁾ Ireland 1997.

Table 31

Temporary employees by occupation

Thousands

IRL ⁽²⁾	I	L	NL	A	P	FIN	S	UK	
Males and Females									
.	10	.	17	4	(3)	(4)	.	76	Legislators and managers (1)
19	151	(1)	99	25	54	83	78	420	Professionals (2)
(3)	171	(1)	79	21	48	56	71	115	Technicians (3)
14	195	(1)	123	26	65	34	57	306	Clerks (4)
30	178	(1)	158	58	137	63	154	289	Services and sales workers (5)
.	29	.	23	3	16	18	.	13	Agriculture/ fishery workers (6)
9	239	(1)	56	78	126	41	42	104	Craft/related trades workers (7)
(4)	104	.	50	7	54	21	39	98	Plant and machine operators (8)
19	302	(1)	138	16	144	41	44	177	Elementary occupations (9)
.	(7)	.	.	.	5	.	.	.	Armed forces (0)
1	60	0	61	0	0	3	0	0	Non responses
102	1 447	5	805	239	653	365	495	1 602	All in temporary employment
Males									
.	8	.	(9)	3	.	.	.	41	Legislators and managers (1)
6	45	.	41	10	21	31	36	187	Professionals (2)
.	83	.	29	8	23	18	27	51	Technicians (3)
.	69	.	39	8	18	10	15	109	Clerks (4)
8	69	.	42	16	41	10	29	72	Services and sales workers (5)
.	18	.	13	.	10	10	.	11	Agriculture/ fishery workers (6)
7	196	(1)	45	72	98	36	41	99	Craft/related trades workers (7)
(3)	76	.	36	6	37	16	30	80	Plant and machine operators (8)
14	160	.	75	5	72	17	16	112	Elementary occupations (9)
.	(7)	.	.	.	5	.	.	.	Armed forces (0)
0	26	0	27	0	0	2	0	0	Non responses
43	759	3	357	129	326	153	198	764	All in temporary employment
Females									
.	.	.	(7)	35	Legislators and managers (1)
13	106	.	58	16	33	52	42	234	Professionals (2)
.	89	.	50	13	25	38	45	64	Technicians (3)
12	125	(1)	83	18	47	24	41	197	Clerks (4)
22	108	(1)	116	41	96	53	125	217	Services and sales workers (5)
.	11	.	(10)	2	6	7	.	.	Agriculture/ fishery workers (6)
.	43	.	11	6	28	5	.	.	Craft/related trades workers (7)
.	28	.	14	.	17	5	10	18	Plant and machine operators (8)
5	142	.	63	11	72	24	29	64	Elementary occupations (9)
.	Armed forces (0)
0	34	0	34	0	0	1	0	0	Non responses
59	688	3	448	110	327	212	297	838	All in temporary employment

(1) 1998.

(2) 1997.

(3) Greece 1998, Ireland 1997.

(4) Ireland 1997.

Table 32⁽¹⁾

Temporary employees by age group and reason

⁽²⁾ Percentages of Male and/or Female temporary Employees aged 15-64 years, Percentages of Male and/or Female temporary Employees in a given age group⁽²⁾

	EU-15 ⁽⁴⁾	EUR-11 ⁽⁵⁾	B	DK	D	EL ⁽³⁾	E	F
Males and Females								
15-24 years*	38.1	39.5	33.1	47.0	50.4	24.0	31.5	36.5
Could not find a permanent job	24.7	22.8	66.6	22.0	3.5	68.6	70.7	.
Did not want a permanent job	11.4	8.6	8.7	18.2	1.1	.	1.1	.
Contract for training	40.1	43.4	20.9	59.8	77.7	13.3	7.7	31.3
Probationary period	3.6	3.9	.	.	4.4	10.7	2.1	4.9
No reason given	20.2	21.2	(3.6)	.	13.4	(4.5)	18.5	63.8
25-49 years*	53.5	53.2	61.4	43.4	42.7	65.3	60.8	57.3
Could not find a permanent job	43.7	41.3	76.7	58.9	20.3	79.7	77.8	.
Did not want a permanent job	7.4	5.4	8.8	23.2	2.7	4.1	0.7	.
Contract for training	8.2	8.7	4.5	17.3	14.2	3.4	1.6	6.7
Probationary period	5.9	6.7	.	.	16.0	11.0	0.9	7.5
No reason given	34.8	37.9	10.0	.	46.8	(1.8)	19.0	85.9
50-64 years*	8.4	7.3	5.4	9.6	6.9	10.7	7.7	6.1
Could not find a permanent job	43.0	41.0	39.6	74.8	30.8	79.6	72.9	.
Did not want a permanent job	16.3	10.7	33.6	24.9	4.1	.	(1.1)	.
Contract for training	(4.5)
Probationary period	.	4.5	.	.	9.8	(12.5)	.	6.2
No reason given	34.9	41.0	26.7	.	53.8	.	25.3	89.3
Males								
15-24 years*	40.2	41.3	37.0	55.6	51.4	25.3	31.4	41.3
Could not find a permanent job	24.1	22.1	60.9	16.1	3.1	70.5	69.9	.
Did not want a permanent job	10.2	8.0	(6.4)	12.8	1.1	.	1.2	.
Contract for training	42.1	44.9	28.9	71.1	76.7	12.0	8.5	38.1
Probationary period	3.6	4.0	.	.	4.5	11.6	2.0	4.5
No reason given	19.9	20.9	.	.	14.6	.	18.4	57.5
25-49 years*	51.1	51.1	57.1	34.8	41.5	61.9	59.7	53.7
Could not find a permanent job	44.9	42.5	78.0	56.7	17.5	79.7	78.1	.
Did not want a permanent job	5.4	4.2	10.7	22.6	2.6	(3.2)	0.7	.
Contract for training	8.5	8.8	6.9	20.7	14.4	(3.2)	1.4	6.5
Probationary period	6.8	7.5	.	.	18.3	12.1	0.9	8.6
No reason given	34.4	37.1	(4.2)	.	47.2	.	18.9	84.9
50-64 years*	8.7	7.6	6.0	9.6	7.1	12.8	8.9	5.0
Could not find a permanent job	47.4	45.4	(50.2)	70.1	30.4	79.8	74.8	.
Did not want a permanent job	12.8	8.1	(34.7)	(29.8)
Contract for training
Probationary period	10.4	.	.	(9.3)
No reason given	33.6	39.0	.	.	55.0	.	24.0	87.6
Females								
15-24 years*	35.7	37.4	30.3	39.3	49.3	22.4	31.7	31.5
Could not find a permanent job	25.5	23.7	71.8	29.5	4.0	65.9	71.8	.
Did not want a permanent job	12.9	9.4	10.7	25.0	1.1	.	(0.9)	.
Contract for training	37.7	41.5	13.7	45.5	78.8	(15.2)	6.4	22.2
Probationary period	3.5	3.9	.	.	4.3	(9.2)	2.1	5.4
No reason given	20.5	21.5	.	.	11.9	.	18.6	72.4
25-49 years*	56.2	55.6	64.7	51.1	44.1	69.8	62.4	61.1
Could not find a permanent job	42.5	40.0	75.9	60.3	23.5	79.6	77.3	.
Did not want a permanent job	9.3	6.6	7.6	23.5	2.7	(4.9)	0.7	.
Contract for training	8.0	8.7	(2.7)	15.3	14.1	(3.4)	1.9	6.8
Probationary period	5.1	5.9	.	.	13.4	9.7	0.8	6.5
No reason given	35.1	38.8	13.8	.	46.3	.	19.2	86.8
50-64 years*	8.1	6.9	5.1	9.6	6.6	7.8	5.9	7.4
Could not find a permanent job	37.7	35.6	(30.2)	79.0	31.3	79.3	68.6	.
Did not want a permanent job	20.5	13.9	(32.5)	(20.3)	.	.	(3.0)	.
Contract for training	(5.6)
Probationary period	9.1	.	.	(3.8)
No reason given	36.4	43.5	(37.0)	.	52.3	.	28.2	90.4

⁽¹⁾ These percentages were calculated using data from the NEWCRONOS table *et_ga_r*.

⁽²⁾ Non responses to the variable PERMANENCY OF JOB not considered.

⁽³⁾ 1998.

⁽⁴⁾ Greece 1998, Ireland 1998.

⁽⁵⁾ Ireland 1998.

(1) Table 32

Temporary employees by age group and reason

 *Percentages of Male and/or Female temporary Employees aged 15-64 years, Percentages of Male and/or Female temporary Employees in a given age group⁽²⁾

IRL ⁽³⁾	I	L	NL	A	P	FIN	S	UK	
Males and Females									
48.5	26.7	48.3	47.5	63.6	37.4	39.1	29.1	28.8	15-24 years*
34.2	23.7	.	28.0	6.1	39.6	35.1	67.5	28.7	Could not find a permanent job
45.1	2.4	.	67.3	2.5	37.8	47.5	32.5	39.6	Did not want a permanent job
20.7	59.6	70.4	(2.4)	83.7	5.0	14.7	.	10.0	Contract for training
.	5.4	.	.	7.7	9.4	(2.2)	.	.	Probationary period
.	9.1	.	(2.0)	.	8.2	.	.	21.7	No reason given
43.1	63.7	47.0	43.3	33.4	55.6	52.2	58.5	54.0	25-49 years*
61.2	46.2	(20.0)	57.1	28.7	43.3	79.2	84.4	42.4	Could not find a permanent job
21.2	4.5	.	34.2	11.6	37.0	11.1	15.6	21.4	Did not want a permanent job
17.5	23.8	(20.5)	.	17.1	2.8	6.7	.	6.4	Contract for training
.	3.6	(21.6)	.	42.6	6.2	(1.8)	.	.	Probationary period
.	21.8	(30.9)	7.7	.	10.8	.	.	29.8	No reason given
8.4	9.6	.	9.2	3.0	7.0	8.7	12.4	17.2	50-64 years*
(55.6)	51.6	.	24.1	36.3	31.2	88.2	81.3	34.8	Could not find a permanent job
(35.1)	7.8	.	68.8	.	51.9	.	18.7	38.5	Did not want a permanent job
.	10.7	Contract for training
.	.	.	.	42.8	Probationary period
.	27.9	.	(7.0)	.	13.1	.	.	25.9	No reason given
Males									
54.2	27.8	60.9	55.2	70.6	39.1	44.3	32.1	31.7	15-24 years*
32.5	21.6	.	25.6	4.2	36.1	31.8	65.8	33.2	Could not find a permanent job
41.7	(1.6)	.	68.5	3.1	41.5	46.0	34.2	34.5	Did not want a permanent job
25.7	62.9	(78.5)	(2.7)	86.3	(3.1)	18.5	.	12.7	Contract for training
.	6.1	.	.	6.4	10.0	.	.	.	Probationary period
.	7.7	.	(3.0)	.	9.2	.	.	19.7	No reason given
37.9	60.6	(37.3)	37.0	26.7	53.2	48.7	55.4	50.1	25-49 years*
73.1	47.5	.	67.4	22.6	44.9	74.3	83.6	49.3	Could not find a permanent job
.	3.6	.	22.8	13.3	36.1	12.8	16.4	13.3	Did not want a permanent job
(18.5)	24.9	.	.	17.0	2.9	8.1	.	8.1	Contract for training
.	4.0	.	.	47.2	5.6	.	.	.	Probationary period
.	20.0	.	8.3	.	10.5	.	.	29.3	No reason given
(7.8)	11.6	.	7.9	2.7	7.7	7.0	12.5	18.1	50-64 years*
.	51.1	.	(30.0)	.	28.8	81.9	77.7	43.9	Could not find a permanent job
.	(7.2)	.	59.6	.	54.2	.	.	31.4	Did not want a permanent job
.	10.6	Contract for training
.	Probationary period
.	28.6	.	.	.	(14.3)	.	.	24.0	No reason given
Females									
44.3	25.5	(35.8)	41.5	55.4	35.7	35.3	27.1	26.1	15-24 years*
35.7	26.2	.	30.5	8.9	43.4	38.0	68.7	23.7	Could not find a permanent job
48.1	(3.0)	.	66.1	.	33.7	48.8	31.3	45.1	Did not want a permanent job
(16.1)	55.6	56.7	.	79.7	6.9	11.3	.	7.2	Contract for training
.	4.5	.	.	9.6	8.8	.	.	.	Probationary period
.	10.7	.	.	.	7.2	.	.	24.0	No reason given
46.9	67.1	56.4	48.3	41.2	58.0	54.8	60.5	57.5	25-49 years*
54.2	44.9	.	50.8	33.4	41.8	82.3	84.9	36.9	Could not find a permanent job
28.9	5.4	.	41.0	10.4	37.8	10.0	15.1	27.7	Did not want a permanent job
(16.8)	22.7	.	.	17.2	2.6	5.8	.	5.1	Contract for training
.	3.3	.	.	39.0	6.8	.	.	.	Probationary period
.	23.7	.	7.3	.	11.0	.	.	30.3	No reason given
(8.6)	7.4	.	10.2	3.4	6.3	9.9	12.4	16.4	50-64 years*
.	52.4	.	(20.4)	.	34.1	91.4	83.6	25.8	Could not find a permanent job
.	(8.7)	.	74.4	.	49.2	.	.	45.5	Did not want a permanent job
.	(10.7)	Contract for training
.	Probationary period
.	26.7	27.8	No reason given

 (1) These percentages were calculated using data from the NEWCRONOS table *et_ga_r*.

(2) Non responses to the variable PERMANENCY OF JOB not considered.

(3) 1998.

(4) Greece 1998, Ireland 1998.

(5) Ireland 1998.

Table 33

Temporary employees by duration of the work contract

Thousands

	EU-15 ⁽³⁾	EUR-11 ⁽⁴⁾	B	DK	D	EL ⁽¹⁾	E	F
Males and Females								
Less than one month	412	278	48	15	.	11	81	.
From 1 to 3 months	1 683	1 510	51	22	205	20	548	394
From 4 to 6 months	2 686	2 330	53	37	392	63	866	381
From 7 to 12 months	3 749	3 227	101	53	997	90	588	671
From 13 to 18 months	558	350	7	13	143	18	-49	49
From 19 to 24 months	996	887	18	30	382	18	82	168
From 25 to 36 months	1 725	1 624	17	16	1 230	10	80	58
More than 3 years	1 616	1 340	43	51	620	61	55	143
Non responses	3 647	2 887	0	13	198	0	1 177	922
All in temporary employment	17 072	14 433	339	250	4 168	292	3 524	2 787
Males								
Less than one month	213	153	30	7	.	7	52	.
From 1 to 3 months	875	785	13	10	111	14	292	215
From 4 to 6 months	1 361	1 201	23	13	204	36	504	181
From 7 to 12 months	1 743	1 522	38	19	504	44	333	274
From 13 to 18 months	263	176	(4)	(3)	74	11	30	25
From 19 to 24 months	522	475	10	11	191	12	54	88
From 25 to 36 months	885	833	10	9	613	5	54	22
More than 3 years	952	791	17	41	440	36	30	64
Non responses	2 116	1 749	0	6	115	0	750	548
All in temporary employment	8 930	7 685	146	118	2 254	165	2 099	1 418
Females								
Less than one month	199	125	18	8	.	(4)	30	.
From 1 to 3 months	808	725	38	13	93	6	255	179
From 4 to 6 months	1 325	1 129	30	24	188	27	362	200
From 7 to 12 months	2 006	1 705	63	33	493	47	255	396
From 13 to 18 months	295	174	(3)	10	68	7	18	24
From 19 to 24 months	474	411	8	19	192	6	28	80
From 25 to 36 months	841	791	8	7	617	5	26	36
More than 3 years	665	549	26	10	181	25	25	79
Non responses	1 530	1 138	0	7	83	0	427	375
All in temporary employment	8 143	6 748	193	132	1 914	127	1 425	1 369

⁽¹⁾ 1998.⁽²⁾ 1997.⁽³⁾ Greece 1998, Ireland 1997.⁽⁴⁾ Ireland 1997.

Table 33

Temporary employees by duration of the work contract

Thousands

IRL ⁽²⁾	I	L	NL	A	P	FIN	S	UK	
Males and Females									
.	87	.	18	.	.	43	44	63	Less than one month
19	90	(1)	78	19	18	87	53	78	From 1 to 3 months
18	207	(1)	179	31	135	67	129	127	From 4 to 6 months
20	303	(1)	314	35	139	59	126	252	From 7 to 12 months
8	39	.	21	3	6	25	30	147	From 13 to 18 months
7	156	(1)	37	9	9	17	23	39	From 19 to 24 months
7	54	(1)	28	126	8	16	21	54	From 25 to 36 months
9	31	(1)	70	7	338	23	60	104	More than 3 years
13	479	0	61	8	0	28	9	738	Non responses
102	1 447	5	805	239	653	365	495	1 602	All in temporary employment
Males									
.	48	.	(8)	.	.	15	16	31	Less than one month
8	46	.	39	9	8	43	24	41	From 1 to 3 months
8	93	.	85	15	55	31	52	59	From 4 to 6 months
9	128	(1)	133	15	65	22	51	107	From 7 to 12 months
(4)	19	.	(8)	.	(3)	9	9	65	From 13 to 18 months
(3)	94	.	21	4	(4)	6	9	16	From 19 to 24 months
(3)	32	(1)	11	77	(3)	6	.	31	From 25 to 36 months
(3)	16	.	23	5	187	7	26	57	More than 3 years
5	282	0	29	5	0	14	5	357	Non responses
43	759	3	357	129	326	153	198	764	All in temporary employment
Females									
.	40	.	(10)	.	.	28	28	32	Less than one month
11	44	.	38	11	10	44	29	36	From 1 to 3 months
10	114	.	95	16	80	36	77	68	From 4 to 6 months
11	174	(1)	181	21	74	37	75	146	From 7 to 12 months
(4)	20	.	13	3	(3)	17	21	82	From 13 to 18 months
(4)	62	.	16	5	(4)	11	14	23	From 19 to 24 months
(4)	22	(1)	16	48	5	10	15	23	From 25 to 36 months
6	15	.	48	3	151	16	34	47	More than 3 years
8	197	0	32	3	0	14	4	381	Non responses
59	688	3	448	110	327	212	297	838	All in temporary employment

⁽¹⁾ 1998.

⁽²⁾ 1997.

⁽³⁾ Greece 1998, Ireland 1997.

⁽⁴⁾ Ireland 1997.

EMPLOYMENT

Part-time employment

Table 34⁽¹⁾

Part-time employment by age group, as percent of each age group total employment

Percentages of the Male and/or Female population in employment in each age group

	EU-15 ⁽⁴⁾	EUR-11	B ⁽²⁾	DK	D	EL ⁽³⁾	E	F
Males and Females								
15-24 years	22.5	18.8	21.8	46.4	11.5	9.8	13.9	24.9
25-49 years	16.1	15.3	19.6	15.0	19.0	4.6	7.5	16.2
50-64 years	18.5	16.4	18.8	19.0	21.0	6.4	6.7	17.3
65 & + years	47.8	40.7	(55.1)	45.4	56.8	20.6	22.7	43.5
15-64 years	17.3	15.9	19.7	20.6	18.6	5.5	8.2	17.1
All ages	17.7	16.2	19.8	20.8	19.0	6.0	8.3	17.2
Males								
15-24 years	16.1	13.1	11.4	36.0	7.9	7.4	8.6	15.1
25-49 years	3.8	3.8	3.7	4.3	3.8	2.2	2.3	4.1
50-64 years	6.1	5.2	5.2	6.8	4.7	3.1	1.7	5.9
65 & + years	41.3	34.7	.	(31.2)	48.0	15.0	17.1	40.0
15-64 years	5.6	5.1	4.6	9.4	4.5	2.9	2.9	5.4
All ages	6.1	5.5	4.7	9.6	4.9	3.3	3.0	5.6
Females								
15-24 years	30.2	25.7	34.3	57.3	15.5	13.5	22.2	37.0
25-49 years	32.5	31.0	39.8	27.4	38.3	8.3	16.2	31.1
50-64 years	37.7	34.7	45.1	34.6	45.2	13.7	18.9	31.3
65 & + years	59.9	51.7	.	(68.9)	72.1	33.6	32.6	49.9
15-64 years	33.2	31.0	39.9	33.7	36.9	10.0	17.5	31.6
All ages	33.5	31.2	39.9	33.9	37.2	10.5	17.6	31.7

⁽¹⁾ These percentages were calculated in the same as the percentages of the NEWCRONOS table *epp_ga*.⁽²⁾ Only Employees.⁽³⁾ 1998.⁽⁴⁾ Greece 1998.

(a) Table 34

Part-time employment as percent of each age group total employment

Percentages of the Male and/or Female population in employment in each age group

IRL	I	L	NL	A	P	FIN	S	UK	
Males and Females									
22.1	9.8	12.9	59.9	9.7	7.7	33.4	43.8	32.1	15-24 years
14.3	7.9	10.6	34.9	17.8	6.3	8.0	21.0	20.9	25-49 years
18.5	6.6	9.6	36.7	16.3	16.8	11.6	22.8	27.5	50-64 years
25.4	15.1	.	76.9	50.0	50.3	58.3	41.2	75.1	65 & + years
16.6	7.8	10.7	39.1	16.5	8.7	11.9	23.6	24.0	15-64 years
16.7	7.9	10.7	39.4	16.8	11.0	12.2	23.8	24.8	All ages
Males									
16.9	6.0	(8.6)	53.5	4.5	5.5	24.8	30.6	24.6	15-24 years
4.0	2.8	(0.9)	10.1	3.7	2.3	3.9	5.9	3.4	25-49 years
7.2	3.6	.	16.5	5.0	8.4	8.4	8.1	9.8	50-64 years
20.8	14.6	.	72.4	42.6	42.1	57.1	46.7	67.3	65 & + years
7.0	3.2	1.7	17.4	4.0	4.1	7.5	8.7	7.7	15-64 years
7.4	3.4	1.8	17.9	4.4	6.3	7.9	9.4	8.9	All ages
Females									
28.3	15.1	(18.1)	66.6	15.8	10.4	42.7	58.1	40.7	15-24 years
28.6	16.3	25.5	67.6	35.2	10.9	12.6	38.1	42.3	25-49 years
42.6	13.5	24.7	75.3	34.9	27.7	14.6	38.7	50.5	50-64 years
(44.4)	16.3	.	91.0	59.6	61.1	.	.	88.0	65 & + years
30.4	15.7	24.7	68.5	32.3	14.2	16.8	40.1	43.8	15-64 years
30.6	15.7	24.6	68.6	32.5	16.7	17.0	40.0	44.4	All ages

 (1) These percentages were calculated in the same way as the percentages of the NEWCRONOS table *epp_ga*

(2) Only Employees.

(3) 1998.

(4) Greece 1998.

Table 35

Part-time employment by age group and educational attainment level

Thousands

	EU-15 ⁽⁴⁾	EUR-11 ⁽⁵⁾	B ⁽¹⁾	DK	D	EL ⁽²⁾	E	F
Males and Females								
15-24 years	3 954	2 367	65	185	467	39	245	478
Less than upper secondary (L)	1 227	892	30	121	84	16	95	131
Upper secondary level (M)	2 269	1 149	29	62	249	21	95	256
Third level (H)	304	205	5	.	16	.	55	90
Non responses	154	121	0	0	118	0	0	0
25-49 years	16 572	12 160	493	248	4 546	117	684	2 665
Less than upper secondary (L)	4 139	3 456	141	37	755	53	382	914
Upper secondary level (M)	8 443	6 047	195	131	2 836	37	120	1 132
Third level (H)	3 570	2 516	157	79	848	27	182	620
Non responses	420	141	0	1	106	0	0	0
50-59 years	4 714	3 129	84	97	1 341	36	151	662
Less than upper secondary (L)	1 831	1 354	43	26	350	30	126	370
Upper secondary level (M)	1 832	1 200	23	51	726	(4)	10	197
Third level (H)	750	451	18	19	191	.	14	96
Non responses	301	123	0	0	75	0	0	0
All part-time empl. aged 15-59	25 241	17 656	642	530	6 354	192	1 080	3 806
Less than upper secondary (L)	7 198	5 702	214	185	1 190	99	604	1 415
Upper secondary level (M)	12 544	8 397	247	244	3 811	63	225	1 585
Third level (H)	4 624	3 172	180	100	1 054	31	251	806
Non responses	875	386	0	1	299	0	0	0
Males								
15-24 years	1 546	908	18	74	168	18	91	161
Less than upper secondary (L)	536	388	12	52	24	9	37	56
Upper secondary level (M)	839	397	6	20	83	8	36	75
Third level (H)	104	64	18	30
Non responses	68	60	0	0	58	0	0	0
25-49 years	2 221	1 754	51	38	514	35	129	375
Less than upper secondary (L)	594	506	20	7	70	19	51	138
Upper secondary level (M)	960	761	14	19	282	9	30	146
Third level (H)	593	460	17	13	145	7	48	90
Non responses	75	28	0	0	17	0	0	0
50-59 years	772	520	12	15	131	11	22	119
Less than upper secondary (L)	259	206	5	5	23	8	15	51
Upper secondary level (M)	270	174	(4)	7	61	.	.	45
Third level (H)	206	123	(3)	.	41	.	6	22
Non responses	37	17	0	0	6	0	0	0
All part-time empl. aged 15-59	4 539	3 182	82	127	813	64	243	655
Less than upper secondary (L)	1 389	1 100	37	64	116	36	103	245
Upper secondary level (M)	2 069	1 332	24	46	426	19	67	266
Third level (H)	902	646	21	16	189	8	72	143
Non responses	179	105	0	0	82	0	0	0
Females								
15-24 years	2 408	1 459	47	111	299	22	154	317
Less than upper secondary (L)	692	504	19	69	61	7	58	75
Upper secondary level (M)	1 430	752	23	42	166	13	60	181
Third level (H)	200	141	5	.	12	.	36	60
Non responses	86	61	0	0	60	0	0	0
25-49 years	14 351	10 406	442	210	4 032	82	555	2 291
Less than upper secondary (L)	3 546	2 950	121	30	685	34	332	776
Upper secondary level (M)	7 483	5 287	181	112	2 554	28	89	985
Third level (H)	2 978	2 056	140	66	703	20	134	529
Non responses	345	113	0	1	89	0	0	0
50-59 years	3 942	2 609	71	82	1 210	25	128	544
Less than upper secondary (L)	1 572	1 148	38	21	327	21	111	319
Upper secondary level (M)	1 562	1 026	19	44	665	.	8	152
Third level (H)	544	328	15	17	149	.	9	74
Non responses	264	107	0	0	69	0	0	0
All part-time empl. aged 15-59	20 702	14 474	559	403	5 541	128	837	3 151
Less than upper secondary (L)	5 809	4 602	177	121	1 073	62	501	1 170
Upper secondary level (M)	10 475	7 065	223	198	3 386	44	157	1 318
Third level (H)	3 722	2 526	159	84	865	22	179	663
Non responses	695	281	0	1	218	0	0	0

⁽¹⁾ Only Employees.⁽²⁾ 1998.⁽³⁾ 1997.⁽⁴⁾ Greece 1998, Ireland 1997.⁽⁵⁾ Ireland 1997.

Table 35

Part-time employment by age group and educational attainment level

Thousands

IRL ⁽²⁾	I	L	NL	A	P	FIN	S	UK	
Males and Females									
38	173	2	701	49	53	96	151	1 211	15-24 years
15	59	(1)	388	13	32	44	60	138	Less than upper secondary (L)
18	108	(1)	294	36	15	47	67	970	Upper secondary level (M)
5	(6)	.	19	.	(4)	5	22	73	Third level (H)
0	1	0	0	0	2	0	2	31	Non responses
96	1 147	14	1 760	452	183	119	503	3 544	25-49 years
46	495	5	461	104	130	22	73	520	Less than upper secondary (L)
30	508	6	835	313	14	59	283	1 944	Upper secondary level (M)
21	136	3	460	35	18	38	146	803	Third level (H)
0	8	0	4	0	22	0	1	277	Non responses
24	216	2	419	87	98	46	192	1 261	50-59 years
15	162	(1)	171	34	59	23	59	363	Less than upper secondary (L)
5	32	(1)	146	47	.	14	95	482	Upper secondary level (M)
(4)	10	.	101	6	.	8	39	239	Third level (H)
0	11	0	1	0	36	0	1	177	Non responses
159	1 536	18	2 880	588	333	260	847	6 015	All part-time empl. aged 15-59
76	716	7	1 020	152	221	88	192	1 020	Less than upper secondary (L)
53	648	8	1 275	395	30	120	446	3 395	Upper secondary level (M)
30	152	3	580	41	23	52	206	1 115	Third level (H)
0	20	1	5	0	59	1	3	486	Non responses
Males									
17	63	(1)	319	12	21	37	55	492	15-24 years
8	25	.	191	3	12	20	25	61	Less than upper secondary (L)
7	35	.	123	8	8	16	21	393	Upper secondary level (M)
.	.	.	(5)	31	Third level (H)
0	1	0	0	0	1	0	1	7	Non responses
18	257	(1)	290	52	37	31	74	319	25-49 years
11	118	.	61	8	22	7	14	48	Less than upper secondary (L)
(3)	101	.	125	35	6	17	36	135	Upper secondary level (M)
(3)	34	.	102	8	(4)	8	24	89	Third level (H)
0	4	0	3	0	5	0	0	46	Non responses
5	71	.	106	13	24	14	30	196	50-59 years
(4)	51	.	29	4	18	7	12	28	Less than upper secondary (L)
.	12	.	40	7	.	(4)	11	76	Upper secondary level (M)
.	.	.	38	3	.	(3)	.	72	Third level (H)
0	5	0	0	0	5	0	0	20	Non responses
40	391	2	716	77	82	83	160	1 006	All part-time empl. aged 15-59
23	194	.	281	15	51	34	51	136	Less than upper secondary (L)
11	148	(1)	287	50	14	37	68	604	Upper secondary level (M)
6	40	(1)	145	11	6	12	39	193	Third level (H)
0	9	0	3	0	11	0	1	74	Non responses
Females									
22	110	(1)	382	37	32	59	96	720	15-24 years
8	34	(1)	196	9	20	23	35	77	Less than upper secondary (L)
11	73	(1)	172	27	7	31	46	577	Upper secondary level (M)
(3)	.	.	14	.	(4)	(4)	15	42	Third level (H)
0	0	0	0	0	1	0	1	24	Non responses
78	890	13	1 471	401	146	88	429	3 225	25-49 years
35	376	5	401	96	108	15	59	472	Less than upper secondary (L)
26	407	6	710	278	8	42	248	1 809	Upper secondary level (M)
17	102	2	358	27	13	30	122	713	Third level (H)
0	4	0	1	0	17	0	0	231	Non responses
18	145	2	312	73	73	31	162	1 064	50-59 years
11	112	(1)	143	31	42	15	47	335	Less than upper secondary (L)
5	20	(1)	106	40	.	10	84	406	Upper secondary level (M)
(3)	(7)	.	63	3	.	5	31	167	Third level (H)
0	6	0	1	0	30	0	1	157	Non responses
118	1 145	17	2 165	511	251	177	687	5 009	All part-time empl. aged 15-59
53	522	6	740	136	169	54	141	884	Less than upper secondary (L)
42	501	7	988	345	15	84	377	2 791	Upper secondary level (M)
23	112	2	435	30	18	39	168	922	Third level (H)
0	11	1	2	0	49	1	1	412	Non responses

⁽¹⁾ Only Employees.

⁽²⁾ 1998.

⁽³⁾ 1997.

⁽⁴⁾ Greece 1998, Ireland 1997.

⁽⁵⁾ Ireland 1997.

Table 36

Part-time employment by economic activity

Thousands

	EU-15 ⁽³⁾	EUR-11	B ⁽¹⁾	DK	D	EL ⁽²⁾	E	F
	Males and Females							
Agriculture (A-B)	1 128	927	6	12	164	88	73	160
Industry (C-F)	3 062	2 349	56	59	1 047	28	108	368
Mining and quarrying (C)
Manufacturing (D)	2 339	1 805	46	48	820	16	84	275
Electricity, gaz, water supply (E)	64	48	.	.	18	.	.	12
Construction (F)	642	482	8	10	204	12	20	79
Services (G-Q)	22 870	15 331	590	489	5 640	121	965	3 395
Wholesale and retail, repairs (G)	5 131	3 295	104	95	1 405	28	184	538
Hotels and restaurants (H)	1 689	1 027	25	30	337	15	120	183
Transports, communications (I)	973	675	26	24	259	5	35	136
Financial intermediation (J)	705	495	20	10	212	(3)	16	99
Real estate, business activit. (K)	2 573	1 844	42	50	697	10	129	381
Public administration (L)	1 481	1 197	71	16	410	(3)	29	377
Other services (M-Q)	10 317	6 800	300	264	2 320	57	452	1 683
Non responses	311	303	0	1	0	0	0	2
All in part-time employment	27 371	18 910	652	561	6 851	237	1 146	3 925
	Males							
Agriculture (A-B)	429	348	.	6	48	32	36	50
Industry (C-F)	880	658	15	21	186	19	46	106
Mining and quarrying (C)
Manufacturing (D)	586	438	11	18	129	7	31	80
Electricity, gaz, water supply (E)
Construction (F)	273	202	(4)	(3)	53	12	13	23
Services (G-Q)	4 047	2 607	72	112	772	32	185	543
Wholesale and retail, repairs (G)	947	531	13	32	149	8	39	83
Hotels and restaurants (H)	448	268	8	5	74	7	36	47
Transports, communications (I)	355	226	10	11	73	(3)	14	34
Financial intermediation (J)	84	57	.	(3)	23	.	(3)	10
Real estate, business activit. (K)	586	390	(4)	15	133	.	24	78
Public administration (L)	283	234	12	(3)	36	.	6	76
Other services (M-Q)	1 344	901	23	42	284	11	62	214
Non responses	111	107	0	1	0	0	0	1
All in part-time employment	5 467	3 721	89	140	1 006	83	267	700
	Females							
Agriculture (A-B)	699	579	5	5	116	56	37	110
Industry (C-F)	2 181	1 691	41	38	861	9	62	262
Mining and quarrying (C)
Manufacturing (D)	1 753	1 367	35	31	691	9	54	194
Electricity, gaz, water supply (E)	.	36	.	.	16	.	.	9
Construction (F)	369	279	5	7	150	.	7	57
Services (G-Q)	18 823	12 724	518	378	4 868	89	781	2 852
Wholesale and retail, repairs (G)	4 184	2 764	92	63	1 256	20	145	454
Hotels and restaurants (H)	1 241	758	17	25	263	8	84	135
Transports, communications (I)	619	449	15	13	186	.	21	102
Financial intermediation (J)	621	438	19	7	189	(3)	13	89
Real estate, business activit. (K)	1 987	1 454	38	35	563	8	105	303
Public administration (L)	1 198	963	59	13	374	.	22	300
Other services (M-Q)	8 974	5 898	278	222	2 036	46	390	1 469
Non responses	200	196	0	1	0	0	0	1
All in part-time employment	21 904	15 190	564	422	5 845	154	879	3 225

⁽¹⁾ Only Employees.⁽²⁾ 1998.⁽³⁾ Greece 1998.

Table 36

Part-time employment by economic activity

Thousands

IRL	I	L	NL	A	P	FIN	S	UK	
Males and Females									
16	141	.	70	38	235	23	25	77	Agriculture (A-B)
26	294	2	278	81	58	31	89	537	Industry (C-F)
.	Mining and quarrying (C)
17	218	(1)	220	63	39	22	72	397	Manufacturing (D)
.	(5)	.	(7)	14	Electricity, gaz,water supply (E)
9	69	(1)	49	16	19	8	15	124	Construction (F)
221	1 196	17	2 341	497	237	230	818	6 110	Services (G-Q)
58	276	3	473	147	49	57	130	1 583	Wholesale and retail,repairs (G)
39	87	(1)	153	42	19	21	36	581	Hotels and restaurants (H)
8	44	(1)	119	24	6	17	40	230	Transports, communications (I)
6	41	(1)	68	24	(4)	(3)	15	182	Financial intermediation (J)
20	177	2	277	63	23	33	75	593	Real estate,business activit. (K)
6	129	2	135	24	7	7	25	240	Public administration (L)
84	442	8	1 117	173	128	91	496	2 701	Other services (M-Q)
3	0	0	298	0	0	1	0	6	Non responses
266	1 631	19	2 988	616	530	285	933	6 730	All in part-time employment
Males									
9	65	.	24	11	89	14	13	30	Agriculture (A-B)
12	107	.	125	19	23	18	37	146	Industry (C-F)
.	Mining and quarrying (C)
5	54	.	95	14	8	12	29	94	Manufacturing (D)
.	Electricity, gaz,water supply (E)
7	49	.	27	5	15	6	.	49	Construction (F)
48	280	(1)	526	61	54	65	145	1 150	Services (G-Q)
15	62	.	126	14	18	11	22	353	Wholesale and retail,repairs (G)
10	17	.	56	6	8	6	10	157	Hotels and restaurants (H)
(4)	21	.	51	7	(3)	9	22	92	Transports, communications (I)
.	(5)	.	(10)	21	Financial intermediation (J)
5	35	.	82	9	6	14	27	152	Real estate,business activit. (K)
.	55	.	41	.	(3)	.	.	41	Public administration (L)
13	85	.	161	23	14	22	55	334	Other services (M-Q)
1	0	0	105	0	0	0	0	3	Non responses
70	452	2	781	91	167	97	195	1 329	All in part-time employment
Females									
7	76	.	46	27	146	10	12	47	Agriculture (A-B)
14	187	(1)	152	62	35	13	52	391	Industry (C-F)
.	Mining and quarrying (C)
12	164	(1)	125	50	31	11	44	303	Manufacturing (D)
.	11	Electricity, gaz,water supply (E)
.	20	.	22	11	(3)	.	.	75	Construction (F)
174	916	15	1 815	436	183	165	673	4 960	Services (G-Q)
43	214	2	347	133	31	45	108	1 230	Wholesale and retail,repairs (G)
29	70	(1)	97	36	12	15	26	424	Hotels and restaurants (H)
(4)	24	(1)	68	17	(3)	8	18	138	Transports, communications (I)
6	36	(1)	58	22	.	(3)	12	162	Financial intermediation (J)
16	142	(1)	195	53	18	20	48	441	Real estate,business activit. (K)
6	74	(1)	95	23	(4)	5	20	199	Public administration (L)
71	357	8	956	151	114	69	441	2 366	Other services (M-Q)
2	0	0	193	0	0	1	0	3	Non responses
197	1 179	17	2 207	526	364	188	737	5 401	All in part-time employment

(1) Only Employees.

(2) 1998.

(3) Greece 1998.

Table 37

Part-time employment by occupation

Thousands

	EU-15 ⁽⁴⁾	EUR-11 ⁽⁵⁾	B ⁽¹⁾	DK	D	EL ⁽²⁾	E	F
Males and Females								
Legislators and managers (1)	863	474	13	8	120	7	28	92
Professionals (2)	3 010	2 066	140	42	704	25	132	323
Technicians (3)	3 708	2 970	49	105	1 368	14	79	581
Clerks (4)	4 940	3 222	130	91	1 263	12	101	800
Services and sales workers (5)	7 031	4 171	142	173	1 562	36	281	952
Agriculture/ fishery workers (6)	867	719	8	(4)	87	85	49	170
Craft/related trades workers (7)	1 006	783	18	8	237	22	52	136
Plant and machine operators (8)	806	579	20	8	176	6	38	138
Elementary occupations (9)	4 650	3 447	129	123	1 181	31	386	720
Armed forces (0)
Non responses	381	375	1	0	152	0	0	10
All in part-time employment	27 274	18 813	652	561	6 851	237	1 146	3 925
Males								
Legislators and managers (1)	264	164	(4)	5	41	(3)	10	22
Professionals (2)	787	554	13	16	178	6	45	89
Technicians (3)	594	451	9	15	132	6	27	105
Clerks (4)	477	295	11	16	89	.	18	58
Services and sales workers (5)	899	460	11	25	117	9	52	86
Agriculture/ fishery workers (6)	371	301	(3)	(3)	32	29	24	71
Craft/related trades workers (7)	548	418	13	5	94	16	26	87
Plant and machine operators (8)	417	290	9	6	78	(4)	20	70
Elementary occupations (9)	929	613	15	48	183	8	45	104
Armed forces (0)
Non responses	149	145	1	0	63	0	0	7
All in part-time employment	5 443	3 696	89	140	1 006	83	267	700
Females								
Legislators and managers (1)	599	310	9	.	79	(4)	18	69
Professionals (2)	2 223	1 513	128	26	525	19	87	234
Technicians (3)	3 115	2 519	39	90	1 236	8	52	476
Clerks (4)	4 463	2 927	120	75	1 174	11	83	743
Services and sales workers (5)	6 131	3 711	131	148	1 446	26	229	867
Agriculture/ fishery workers (6)	496	418	5	.	56	56	25	99
Craft/related trades workers (7)	458	365	5	(3)	143	5	26	49
Plant and machine operators (8)	389	288	11	.	98	.	18	68
Elementary occupations (9)	3 721	2 834	114	75	998	23	341	616
Armed forces (0)
Non responses	232	229	0	0	89	0	0	3
All in part-time employment	21 831	15 117	564	422	5 845	154	879	3 225

⁽¹⁾ Only Employees.⁽²⁾ 1998.⁽³⁾ 1997.⁽⁴⁾ Greece 1998, Ireland 1997.⁽⁵⁾ Ireland 1997.

Table 37

Part-time employment by occupation

Thousands

IRL ⁽²⁾	I	L	NL	A	P	FIN	S	UK	
Males and Females									
(4)	20	.	148	23	16	11	12	362	Legislators and managers (1)
23	131	2	500	45	26	40	94	783	Professionals (2)
5	209	4	523	96	19	36	129	491	Technicians (3)
25	262	3	476	120	17	24	126	1 488	Clerks (4)
66	301	2	600	135	50	79	369	2 281	Services and sales workers (5)
(3)	74	.	50	34	218	24	22	38	Agriculture/ fishery workers (6)
8	147	(1)	104	27	40	13	31	163	Craft/related trades workers (7)
5	67	.	103	18	(4)	9	45	169	Plant and machine operators (8)
30	336	5	356	117	140	47	103	947	Elementary occupations (9)
.	Armed forces (0)
1	84	0	125	0	0	2	1	6	Non responses
169	1 631	19	2 988	616	530	285	933	6 730	All in part-time employment
Males									
.	8	.	58	7	7	7	.	87	Legislators and managers (1)
(4)	42	.	145	11	10	15	26	186	Professionals (2)
.	57	.	81	18	10	10	28	94	Technicians (3)
.	38	.	61	7	(4)	6	15	150	Clerks (4)
12	47	.	102	8	14	12	34	371	Services and sales workers (5)
.	39	.	23	10	83	14	12	26	Agriculture/ fishery workers (6)
5	84	.	71	13	16	9	24	84	Craft/related trades workers (7)
(4)	28	.	66	6	(3)	6	30	87	Plant and machine operators (8)
13	86	.	123	9	19	16	22	239	Elementary occupations (9)
.	Armed forces (0)
0	24	0	49	0	0	1	0	3	Non responses
45	452	2	781	91	167	97	195	1 329	All in part-time employment
Females									
(3)	12	.	90	16	9	(4)	.	275	Legislators and managers (1)
18	88	2	355	34	16	25	68	597	Professionals (2)
(3)	153	3	442	79	9	26	101	396	Technicians (3)
23	224	3	414	113	12	19	111	1 338	Clerks (4)
54	255	2	498	127	36	67	335	1 911	Services and sales workers (5)
.	36	.	27	24	135	10	10	12	Agriculture/ fishery workers (6)
(3)	62	.	33	14	23	(4)	.	78	Craft/related trades workers (7)
.	40	.	37	12	.	(3)	15	82	Plant and machine operators (8)
17	250	5	233	108	120	31	81	707	Elementary occupations (9)
.	Armed forces (0)
0	60	0	76	0	0	1	0	2	Non responses
124	1 179	17	2 207	526	364	188	737	5 401	All in part-time employment

⁽¹⁾ Only Employees.

⁽²⁾ 1998.

⁽³⁾ 1997.

⁽⁴⁾ Greece 1998, Ireland 1997.

⁽⁵⁾ Ireland 1997.

Table 38⁽¹⁾

Part-time employment by reason

Percentages of the Male and/or Female population in part-time employment

	EU-15 ⁽⁴⁾	EUR-11	B ⁽²⁾	DK	D	EL ⁽³⁾	E	F
	Males and Females							
Could not find a full-time job	16.9	18.3	20.3	15.3	13.0	44.8	25.1	27.5
Did not want a full-time job	59.5	56.1	9.7	50.0	73.0	29.9	5.8	65.0
In education or training	11.1	9.1	2.0	30.4	8.0	4.1	6.0	7.3
Own illness or disability	2.6	2.5	2.6	3.9	2.3	3.2	0.9	.
Other reason given	8.3	11.8	65.4	.	.	17.1	60.9	.
No reason given	1.7	2.3	.	.	3.7	.	1.3	(0.2)
	Males							
Could not find a full-time job	24.4	24.9	30.9	12.6	18.0	52.5	26.2	41.2
Did not want a full-time job	36.1	35.2	7.9	27.9	41.6	19.5	4.7	41.6
In education or training	25.3	22.1	8.5	51.5	27.1	5.6	13.2	17.0
Own illness or disability	5.4	5.6	(4.5)	7.0	5.8	(4.8)	2.5	.
Other reason given	6.5	9.2	48.2	.	.	16.8	52.5	.
No reason given	2.3	3.1	.	.	7.5	.	(1.0)	.
	Females							
Could not find a full-time job	15.0	16.6	18.6	16.2	12.2	40.7	24.8	24.5
Did not want a full-time job	65.4	61.2	10.0	57.3	78.4	35.6	6.1	70.1
In education or training	7.5	5.9	1.0	23.5	4.7	3.3	3.8	5.1
Own illness or disability	1.9	1.8	2.3	2.8	1.7	(2.3)	(0.4)	.
Other reason given	8.7	12.4	68.1	.	.	17.2	63.5	.
No reason given	1.5	2.0	.	.	3.0	.	1.4	(0.2)

⁽¹⁾ These percentages were calculated using data from the NEWCRONOS table *ep_ga_r*. Non responses to the variable FULL-TIME/PART-TIME DISTINCTION not considered.

⁽²⁾ Only Employees.

⁽³⁾ 1998.

⁽⁴⁾ Greece 1998.

(1) Table 38

Part-time employment by reason

Percentages of the Male and/or Female population in part-time employment

IRL	I	L	NL	A	P	FIN	S	UK	
Males and Females									
12.7	36.4	9.8	4.3	11.3	23.7	37.9	29.6	10.3	Could not find a full-time job
31.2	23.7	52.5	72.0	15.1	25.7	20.2	47.4	72.8	Did not want a full-time job
16.0	3.3	(5.8)	18.9	5.8	6.1	27.4	13.4	14.8	In education or training
(1.1)	1.7	.	4.8	1.6	19.4	3.3	9.1	1.7	Own illness or disability
.	32.1	22.9	.	66.1	25.0	10.9	.	.	Other reason given
39.0	2.8	(6.9)	0.4	No reason given
Males									
26.0	44.9	.	6.7	22.1	20.3	32.6	33.5	21.2	Could not find a full-time job
17.7	16.8	.	49.6	17.5	38.8	23.4	24.7	42.1	Did not want a full-time job
28.5	5.0	(37.3)	35.5	18.5	9.1	34.2	24.8	33.0	In education or training
.	3.5	.	8.2	3.8	31.0	(3.4)	16.3	3.1	Own illness or disability
.	25.5	(28.2)	.	38.1	.	6.4	.	.	Other reason given
25.4	4.2	No reason given
Females									
8.0	33.1	9.9	3.5	9.4	25.3	40.7	28.6	7.6	Could not find a full-time job
36.0	26.3	55.9	80.0	14.7	19.7	18.6	53.4	80.4	Did not want a full-time job
11.5	2.6	.	13.0	3.7	4.8	24.0	10.4	10.3	In education or training
.	1.0	.	3.6	1.3	14.1	3.2	7.2	1.4	Own illness or disability
.	34.7	22.4	.	71.0	36.1	13.2	.	.	Other reason given
43.9	2.3	(7.7)	0.3	No reason given

(1) These percentages were calculated using data from the NEWCRONOS table *ep_ga_r*. Non responses to the variable FULL-TIME/PART-TIME DISTINCTION not considered.

(2) Only Employees.

(3) 1998.

(4) Greece 1998.

Table 39⁽¹⁾

Involuntary part-time employment as percent of total part-time employment, by age group

Percentages of the Male and/or Female population in part-time employment

	EU-15 ⁽⁴⁾	EUR-11	B ⁽²⁾	DK	D	EL ⁽³⁾	E	F
	Males and Females							
15-24 years	3.0	3.1	5.1	3.3	1.2	9.3	6.4	5.3
25-49 years	11.0	12.4	13.9	8.4	9.0	27.5	16.5	19.2
50-64 years	2.8	2.6	1.2	3.5	2.8	7.3	2.2	3.0
65 & + years								
15-64 years	16.8	18.2	20.2	15.2	13.0	44.1	25.0	27.5
All ages	16.9	18.3	20.3	15.3	13.0	44.8	25.1	27.5
	Males							
15-24 years	4.8	4.5	9.0	4.1	2.1	11.8	8.8	7.9
25-49 years	15.2	16.6	19.7	5.3	12.0	30.0	16.0	28.5
50-64 years	4.1	3.6		(2.9)	3.7	9.9	(1.5)	4.8
65 & + years								
15-64 years	24.1	24.7	30.9	12.4	17.8	51.7	26.2	41.2
All ages	24.4	24.9	30.9	12.6	18.0	52.5	26.2	41.2
	Females							
15-24 years	2.6	2.8	4.5	3.0	1.0	7.9	5.7	4.7
25-49 years	9.9	11.4	13.0	9.4	8.5	26.1	16.6	17.2
50-64 years	2.4	2.4	1.1	3.7	2.6	5.9	2.4	2.6
65 & + years								
15-64 years	14.9	16.6	18.5	16.1	12.1	40.0	24.7	24.5
All ages	15.0	16.6	18.6	16.2	12.2	40.7	24.8	24.5

⁽¹⁾ These percentages were calculated in the same way as the percentages of the NEWCRONOS table *epp_ga_i*.⁽²⁾ Only Employees.⁽³⁾ 1998.⁽⁴⁾ Greece 1998.

(1) Table 39

Involuntary part-time employment as percent of total part-time employment, by age group

Percentages of the Male and or Female population in part-time employment

IRL	I	L	NL	A	P	FIN	S	UK	
Males and Females									
2.9	6.1	.	1.2	1.9	3.2	7.8	5.1	2.2	15-24 years
7.4	25.9	(6.0)	2.9	7.0	12.9	21.8	18.7	5.4	25-49 years
2.4	4.3	.	(0.2)	2.1	6.7	8.1	5.8	2.5	50-64 years
.	0.9	.	.	0.2	65 & + years
12.6	36.3	9.8	4.3	11.0	22.8	37.7	29.6	10.1	15-64 years
12.7	36.4	9.8	4.3	11.3	23.7	37.9	29.6	10.3	All ages
Males									
(4.2)	7.1	.	1.3	2.3	3.2	8.1	7.2	4.7	15-24 years
15.2	31.4	.	4.9	12.7	9.4	17.7	21.5	10.6	25-49 years
6.5	6.2	.	.	5.9	5.5	6.2	4.8	5.4	50-64 years
.	(2.2)	.	.	.	65 & + years
25.8	44.7	.	6.7	21.0	18.1	32.1	33.5	20.7	15-64 years
26.0	44.9	.	6.7	22.1	20.3	32.6	33.5	21.2	All ages
Females									
2.5	5.7	.	1.1	1.9	3.2	7.7	4.5	1.6	15-24 years
4.6	23.7	(6.2)	2.2	6.0	14.5	23.9	18.0	4.2	25-49 years
.	3.6	.	.	1.4	7.3	9.1	6.1	1.8	50-64 years
.	65 & + years
8.0	33.1	9.9	3.5	9.3	25.0	40.7	28.6	7.5	15-64 years
8.0	33.1	9.9	3.5	9.4	25.3	40.7	28.6	7.6	All ages

 (1) These percentages were calculated in the same way as the percentages of the NEWCRONOS table *epp_ga_i*.

(2) Only Employees.

(3) 1998.

(4) Greece 1998.

EMPLOYMENT

All in employment having a second job

Table 40⁽¹⁾

Persons in employment having a second job by professional status of both jobs

*Percentages of Male and/or Female population w/ second job. Percentages of Male and/or Female population w/ second job and a given professional status in first job

	EU-15 ⁽²⁾	EUR-11	B	DK	D	EL ⁽²⁾	E	F
	Males and Females							
First job self-employed*	18.2	19.0	19.2	10.1	12.5	48.4	30.5	17.7
Second job self-employed	53.9	56.8	48.2	26.1	58.4	65.0	63.6	51.6
Second job employee	41.2	39.2	51.0	69.5	37.1	16.8	30.8	48.4
Second job family worker	18.2	(5.5)	.
First job employee*	80.6	79.8	79.6	89.0	86.7	40.4	67.4	81.3
Second job self-employed	33.5	37.7	47.8	28.3	43.1	53.3	40.0	18.0
Second job employee	61.6	56.7	45.6	69.5	49.7	21.3	54.5	82.0
Second job family worker	4.9	5.6	6.6	(2.0)	7.2	25.4	5.5	.
First job family worker*	1.3	1.3	.	.	.	11.2	(2.0)	(0.9)
Second job self-employed	(15.4)	.	.
Second job employee	(13.1)	.	(85.7)
Second job family worker	71.3	(65.5)	.
	Males							
First job self-employed*	23.7	23.4	22.0	12.6	15.2	54.0	35.1	28.1
Second job self-employed	57.9	59.5	47.3	(29.1)	62.3	68.1	67.5	55.3
Second job employee	37.1	36.5	52.7	70.8	33.2	16.8	26.7	44.7
Second job family worker	15.1	(5.7)	.
First job employee*	75.4	75.7	77.5	86.9	84.5	40.6	62.8	70.9
Second job self-employed	45.8	49.3	55.5	41.5	54.2	58.3	49.7	29.6
Second job employee	48.5	44.4	39.9	57.6	38.8	17.7	43.7	70.4
Second job family worker	5.7	6.3	(4.5)	.	7.0	24.1	6.6	.
First job family worker*	5.4	(2.0)	(0.9)
Second job self-employed
Second job employee
Second job family worker	61.4	.	.
	Females							
First job self-employed*	11.2	12.4	14.0	(6.0)	8.5	24.0	18.3	8.5
Second job self-employed	43.0	49.2	(50.6)	.	48.2	(34.2)	44.0	40.8
Second job employee	52.0	46.9	(45.9)	(64.8)	47.7	.	51.5	59.2
Second job family worker	(48.3)	.	.
First job employee*	87.1	85.8	83.5	92.3	90.0	39.8	79.6	90.5
Second job self-employed	20.1	22.6	34.6	8.7	27.5	(31.0)	19.8	10.0
Second job employee	76.0	72.8	55.3	87.4	65.0	37.5	77.2	90.0
Second job family worker	3.9	4.6	10.1	(3.8)	7.6	(31.3)	.	.
First job family worker*	36.2	.	(0.9)
Second job self-employed
Second job employee
Second job family worker	77.7	.	.

⁽¹⁾ These percentages were calculated using data from the NEWCRONOS table e2_ga_p. Non responses to the variables PROFESSIONAL STATUS IN FIRST JOB and PROFESSIONAL STATUS IN SECOND JOB not considered.

⁽²⁾ 1998.

⁽³⁾ Greece 1998.

(1) Table 40

Persons in employment having a second job by professional status of both jobs

*Percentages of Male and/or Female population w/ second job, Percentages of Male and/or Female population w/ second job and a given professional status in first job

IRL	I	L	NL	A	P	FIN	S	UK	
Males and Females									
29.0	33.2	.	17.8	15.2	22.3	18.8	13.1	14.3	First job self-employed*
64.3	69.7	.	43.1	16.2	73.2	54.0	32.3	46.9	Second job self-employed
(32.4)	21.2	.	54.2	77.4	21.3	44.5	56.2	53.1	Second job employee
.	9.0	.	.	.	(5.3)	.	.	.	Second job family worker
70.1	63.6	93.3	81.2	82.7	76.4	80.4	86.3	85.7	First job employee*
55.7	65.7	(25.0)	27.6	22.3	69.0	35.4	28.3	24.5	Second job self-employed
36.0	22.1	74.9	70.3	64.8	19.1	60.8	59.4	75.5	Second job employee
.	12.2	.	(2.0)	13.0	11.9	(3.7)	12.3	.	Second job family worker
.	3.2	.	(1.0)	2.0	(1.2)	.	.	.	First job family worker*
.	Second job self-employed
.	.	.	.	73.5	Second job employee
.	(39.5)	Second job family worker
Males									
33.7	34.8	.	19.4	16.4	22.9	23.8	16.9	20.8	First job self-employed*
64.9	70.0	.	40.2	18.5	74.5	63.5	39.8	53.1	Second job self-employed
.	21.1	.	57.7	75.4	20.3	(34.2)	48.6	46.9	Second job employee
.	(8.7)	Second job family worker
65.5	62.8	(82.8)	80.1	82.5	76.6	76.0	83.1	79.2	First job employee*
68.5	74.1	.	33.0	28.3	73.1	45.4	41.0	34.7	Second job self-employed
(21.6)	15.3	.	64.5	57.4	14.6	50.4	48.1	65.3	Second job employee
.	10.6	.	.	14.3	12.3	.	10.9	.	Second job family worker
.	(2.3)	First job family worker*
.	Second job self-employed
.	Second job employee
.	Second job family worker
Females									
.	27.5	.	16.1	12.0	21.0	12.9	8.7	9.5	First job self-employed*
.	68.5	.	46.7	.	70.2	.	.	37.0	Second job self-employed
.	(21.6)	.	50.0	85.1	(23.7)	(66.5)	73.5	63.0	Second job employee
.	Second job family worker
86.7	66.4	(99.9)	82.2	83.5	76.1	85.6	90.1	90.5	First job employee*
.	39.1	.	22.2	.	60.0	24.9	14.7	18.0	Second job self-employed
(75.5)	43.8	(81.7)	76.1	85.4	29.0	71.6	71.4	82.0	Second job employee
.	(17.1)	.	.	9.4	11.0	.	13.9	.	Second job family worker
.	(5.9)	First job family worker*
.	Second job self-employed
.	Second job employee
.	Second job family worker

(1) These percentages were calculated using data from the NEWCRONOS table e2_ga_p. Non responses to the variables PROFESSIONAL STATUS IN FIRST JOB and PROFESSIONAL STATUS IN SECOND JOB not considered.

(2) 1998.

(3) Greece 1998.

Table 41

Persons in employment having a second job by occupation in first job

Thousands

	EU-15 ⁽³⁾	EUR-11 ⁽⁴⁾	B	DK	D	EL ⁽¹⁾	E	F
Males and Females								
Legislators and managers (1)	437	245	16	10	59	29	26	41
Professionals (2)	1 175	745	48	37	167	23	63	170
Technicians (3)	755	515	17	35	187	6	19	119
Clerks (4)	568	310	19	18	110	8	14	65
Services and sales workers (5)	704	340	10	31	84	17	17	92
Agriculture/ fishery workers (6)	272	190	5	(4)	25	52	25	63
Craft/related trades workers (7)	524	363	15	18	135	28	23	44
Plant and machine operators (8)	335	211	12	11	63	14	17	34
Elementary occupations (9)	529	357	11	20	68	11	29	125
Armed forces (0)	.	.	(3)	(3)	.	.	.	(4)
Non responses	.	37	.	.	9	.	.	.
All in employment w/ second job	5 360	3 330	156	188	913	189	235	757
Males								
Legislators and managers (1)	327	195	14	8	45	25	22	30
Professionals (2)	718	490	28	28	119	18	46	103
Technicians (3)	375	265	12	17	88	5	12	55
Clerks (4)	188	117	9	8	38	7	7	14
Services and sales workers (5)	182	103	(4)	10	21	10	7	13
Agriculture/ fishery workers (6)	216	149	(3)	(3)	18	43	23	50
Craft/related trades workers (7)	472	324	13	18	122	27	21	37
Plant and machine operators (8)	286	180	11	10	54	13	16	27
Elementary occupations (9)	200	134	5	10	30	7	15	22
Armed forces (0)	.	.	(3)	(3)
Non responses
All in employment w/ second job	3 004	1 989	101	115	547	153	171	355
Females								
Legislators and managers (1)	111	50	(3)	.	13	(4)	(4)	11
Professionals (2)	457	255	20	9	49	6	17	66
Technicians (3)	380	251	6	18	99	.	7	63
Clerks (4)	379	193	10	10	72	.	7	51
Services and sales workers (5)	522	237	5	21	63	7	11	80
Agriculture/ fishery workers (6)	56	41	.	.	.	9	.	14
Craft/related trades workers (7)	.	39	.	.	13	.	.	(6)
Plant and machine operators (8)	.	31	.	.	8	.	.	(7)
Elementary occupations (9)	328	222	6	10	38	(4)	14	103
Armed forces (0)
Non responses
All in employment w/ second job	2 356	1 341	55	73	366	35	64	402

⁽¹⁾ 1998.⁽²⁾ 1997.⁽³⁾ Greece 1998, Ireland 1997.⁽⁴⁾ Ireland 1997.

Table 41

Persons in employment having a second job by occupation in first job

Thousands

IRL ⁽²⁾	I	L	NL	A	P	FIN	S	UK	
Males and Females									
.	18	.	43	16	16	8	19	134	Legislators and managers (1)
5	84	.	122	26	39	20	80	289	Professionals (2)
.	40	.	80	21	19	12	69	130	Technicians (3)
.	22	.	40	18	15	5	31	200	Clerks (4)
(3)	31	.	54	13	25	12	64	251	Services and sales workers (5)
5	13	.	(8)	13	25	8	15	12	Agriculture/ fishery workers (6)
(3)	26	.	17	29	63	8	33	82	Craft/related trades workers (7)
.	14	.	17	17	32	(4)	37	61	Plant and machine operators (8)
(4)	24	(1)	35	12	41	8	18	123	Elementary occupations (9)
.	Armed forces (0)
.	11	.	14	Non responses
28	283	2	431	164	276	86	368	1 285	All in employment w/ second job
Males									
.	17	.	33	13	14	5	15	84	Legislators and managers (1)
(3)	64	.	71	19	27	10	44	139	Professionals (2)
.	30	.	32	15	14	6	36	52	Technicians (3)
.	14	.	14	9	9	.	9	48	Clerks (4)
.	19	.	15	7	13	(3)	14	45	Services and sales workers (5)
5	12	.	(6)	10	15	6	11	11	Agriculture/ fishery workers (6)
(3)	24	.	15	27	55	8	31	72	Craft/related trades workers (7)
.	12	.	12	17	26	(4)	33	50	Plant and machine operators (8)
(3)	18	.	15	5	18	(3)	.	43	Elementary occupations (9)
.	Armed forces (0)
.	(7)	Non responses
22	218	(1)	217	121	190	47	201	546	All in employment w/ second job
Females									
.	.	.	(10)	3	.	(3)	.	51	Legislators and managers (1)
.	19	.	51	8	13	10	36	150	Professionals (2)
.	9	.	48	6	5	6	33	78	Technicians (3)
.	8	.	26	9	6	(4)	22	152	Clerks (4)
.	12	.	39	6	12	9	51	206	Services and sales workers (5)
.	.	.	.	3	10	.	.	.	Agriculture/ fishery workers (6)
.	8	.	.	.	Craft/related trades workers (7)
.	.	.	(5)	.	6	.	.	11	Plant and machine operators (8)
.	(6)	(1)	19	7	24	5	13	80	Elementary occupations (9)
.	Armed forces (0)
.	(5)	.	11	Non responses
5	65	(1)	214	43	86	39	168	740	All in employment w/ second job

⁽¹⁾ 1998.

⁽²⁾ 1997.

⁽³⁾ Greece 1998, Ireland 1997.

⁽⁴⁾ Ireland 1997.

EMPLOYMENT

Working time

Table 42⁽¹⁾
Population usually working shift work, in the evening, at night, on Saturday or on Sunday, as percentage of the total employment

Percentages of the Male and/or Female population Employed

	EU-15 ⁽⁵⁾	EUR-11 ⁽⁶⁾	B	DK	D ⁽⁴⁾	EL ⁽³⁾	E ⁽²⁾	F
	Males and Females							
Usually work shift work	11.7	11.4	8.8	7.2	10.7	13.3	7.7	9.4
Usually work in the evening	17.2	13.1	5.1	20.9	18.5	29.0	9.6	8.5
Usually work at night	7.0	5.8	2.7	7.9	7.0	4.1	6.9	3.9
Usually work on Saturday	27.9	27.7	9.6	24.3	22.9	43.0	35.4	24.0
Usually work on Sunday	11.9	10.9	4.7	18.9	11.3	14.3	14.1	8.5
	Males							
Usually work shift work	13.1	12.9	10.6	7.2	12.2	15.0	8.7	11.4
Usually work in the evening	18.5	14.3	5.5	21.8	20.1	29.5	10.3	9.9
Usually work at night	8.5	7.1	3.2	8.8	8.8	4.9	7.7	5.4
Usually work on Saturday	27.8	27.2	8.9	22.0	21.9	45.2	34.3	22.5
Usually work on Sunday	11.8	11.0	4.7	17.4	11.3	15.2	14.1	8.6
	Females							
Usually work shift work	9.9	9.5	6.3	7.2	8.7	10.7	6.1	7.0
Usually work in the evening	15.4	11.5	4.7	19.9	16.4	28.0	8.4	6.9
Usually work at night	4.9	4.0	1.9	6.9	4.6	2.5	5.6	2.2
Usually work on Saturday	28.0	28.3	10.7	27.0	24.1	39.1	37.3	25.9
Usually work on Sunday	12.1	10.8	4.7	20.6	11.3	12.8	14.1	8.3

⁽¹⁾ These percentages were calculated using data from the NEWCRONOS tables *ewp_shi*, *ewp_eve*, *ewp_nig*, *ewp_sat* and *ewp_sun*. Non responses to the variables concerning ATYPICAL WORK not considered.

⁽²⁾ 1999, first quarter.

⁽³⁾ 1998.

⁽⁴⁾ 1997.

⁽⁵⁾ Germany 1997, Greece 1998, Spain 1999-first quarter, Ireland 1997, Luxembourg 1998.

⁽⁶⁾ Germany 1997, Spain 1999-first quarter, Ireland 1997, Luxembourg 1998.

(1) Table 42

Population usually working shift work, in the evening, at night, on Saturday or on Sunday, as percentage of the total employment

Percentages of the Male and/or Female population Employed

IRL ⁽⁴⁾	I	L ⁽³⁾	NL	A	P	FIN	S	UK	
Males and Females									
9.8	18.9	10.8	8.5	16.1	7.9	23.1	25.0	11.2	Usually work shift work
11.6	13.0	9.2	17.0	14.8	.	24.2	22.5	32.7	Usually work in the evening
6.2	5.2	3.0	2.3	9.5	8.9	8.7	7.6	12.7	Usually work at night
30.4	38.5	19.0	27.1	26.5	29.4	25.2	19.8	28.3	Usually work on Saturday
17.2	8.3	8.1	15.2	15.2	12.0	17.9	18.0	14.5	Usually work on Sunday
Males									
9.9	20.6	13.0	9.3	17.2	9.0	21.1	20.0	13.6	Usually work shift work
12.9	14.5	9.1	16.7	17.1	.	25.1	21.7	36.3	Usually work in the evening
6.8	6.2	3.5	2.6	11.7	10.9	9.8	8.8	15.9	Usually work at night
34.6	38.3	16.3	26.7	23.3	30.7	26.0	16.1	30.1	Usually work on Saturday
20.2	8.7	8.3	14.5	14.9	12.3	18.5	15.1	14.1	Usually work on Sunday
Females									
9.7	16.3	7.4	7.4	14.8	6.6	25.2	29.9	8.7	Usually work shift work
9.6	10.4	9.4	17.3	11.8	.	23.2	23.3	28.3	Usually work in the evening
5.1	3.5	(1.9)	1.8	6.7	6.6	7.5	6.2	8.7	Usually work at night
23.8	39.0	23.6	27.7	30.5	27.7	24.2	23.7	26.2	Usually work on Saturday
12.4	7.7	7.9	16.2	15.6	11.6	17.1	21.0	15.0	Usually work on Sunday

(1) These percentages were calculated using data from the NEWCRONOS tables *ewp_shi*, *ewp_eve*, *ewp_nig*, *ewp_sat* and *ewp_sun*. Non responses to the variables concerning ATYPICAL WORK not considered.

(2) 1999, first quarter.

(3) 1998.

(4) 1997.

(5) Germany 1997, Greece 1998, Spain 1999-first quarter, Ireland 1997, Luxembourg 1998.

(6) Germany 1997, Spain 1999-first quarter, Ireland 1997, Luxembourg 1998.

Table 43

Persons working shift work, in the evening, at night, on Saturday or on Sunday

Thousands

	EU-15 ⁽⁴⁾	EUR-11 ⁽⁵⁾	B	DK	D ⁽³⁾	EL ⁽²⁾	E ⁽¹⁾	F
Males and Females								
Usually work shift work	15 155	11 503	290	177	3 756	299	810	1 878
Sometimes work shift work	1 854	1 293	.	28	359	109	116	.
Never work shift work	112 293	87 708	3 009	2 242	30 889	1 837	9 574	18 111
Non responses	3 632	307	0	9	295	0	0	0
Usually work in the evening	26 113	15 195	204	563	6 497	1 150	1 302	1 942
Sometimes work in the evening	27 168	18 727	1 142	506	4 778	1 387	1 133	5 938
Never work in the evening	98 600	81 933	2 642	1 622	23 774	1 430	11 068	14 853
Non responses	2 105	296	0	17	251	0	0	21
Usually work at night	10 601	6 704	107	213	2 443	161	937	896
Sometimes work at night	12 588	9 098	494	185	1 928	417	885	2 761
Never work at night	128 671	100 033	3 386	2 289	30 658	3 389	11 681	19 089
Non responses	2 127	315	0	20	270	0	0	7
Usually work on Saturday	41 999	32 073	384	654	8 019	1 705	4 781	5 458
Sometimes work on Saturday	31 846	21 974	1 089	540	6 308	844	738	6 631
Never work on Saturday	76 584	61 853	2 514	1 495	20 754	1 417	7 984	10 660
Non responses	3 558	251	0	19	218	0	0	5
Usually work on Sunday	17 925	12 673	187	507	3 977	569	1 904	1 930
Sometimes work on Sunday	22 891	14 731	727	447	3 946	729	513	4 785
Never work on Sunday	109 593	88 480	3 074	1 731	27 144	2 669	11 087	16 033
Non responses	3 577	267	0	22	232	0	0	7
All in employment	153 987	116 151	3 987	2 708	35 299	3 967	13 503	22 755
Males								
Usually work shift work	9 524	7 422	201	93	2 446	207	567	1 226
Sometimes work shift work	1 245	876	.	15	244	75	80	.
Never work shift work	61 915	49 227	1 686	1 173	17 318	1 102	5 876	9 493
Non responses	2 008	158	0	3	150	0	0	0
Usually work in the evening	16 279	9 696	126	317	4 031	739	891	1 243
Sometimes work in the evening	18 264	12 880	765	319	3 311	894	802	4 030
Never work in the evening	53 317	45 299	1 415	815	12 690	871	6 916	7 293
Non responses	1 201	149	0	9	126	0	0	10
Usually work at night	7 461	4 806	75	128	1 758	124	662	674
Sometimes work at night	9 393	6 818	369	130	1 450	317	650	2 130
Never work at night	70 989	56 235	1 862	1 192	16 813	2 063	7 297	9 768
Non responses	1 218	165	0	11	138	0	0	4
Usually work on Saturday	24 177	18 491	204	319	4 397	1 133	2 957	2 824
Sometimes work on Saturday	21 223	14 800	671	343	4 369	564	514	4 229
Never work on Saturday	41 425	34 607	1 431	787	11 284	807	5 137	5 522
Non responses	2 237	126	0	10	108	0	0	1
Usually work on Sunday	10 249	7 484	107	252	2 272	382	1 215	1 084
Sometimes work on Sunday	15 166	9 679	433	289	2 693	498	348	2 973
Never work on Sunday	61 400	50 728	1 765	906	15 077	1 624	7 046	8 517
Non responses	2 247	134	0	13	116	0	0	3
All in employment	89 062	68 025	2 306	1 460	20 159	2 504	8 609	12 577
Females								
Usually work shift work	5 631	4 081	89	84	1 309	92	244	652
Sometimes work shift work	610	417	.	14	115	34	37	.
Never work shift work	50 378	38 482	1 323	1 069	13 571	735	3 698	8 618
Non responses	1 623	149	0	6	145	0	0	0
Usually work in the evening	9 834	5 499	79	246	2 466	410	412	699
Sometimes work in the evening	8 904	5 847	376	187	1 467	494	331	1 908
Never work in the evening	45 284	36 634	1 227	806	11 083	559	4 152	7 559
Non responses	903	146	0	8	124	0	0	11
Usually work at night	3 140	1 898	32	85	685	37	275	222
Sometimes work at night	3 195	2 280	125	55	479	99	235	631
Never work at night	57 681	43 798	1 524	1 097	13 845	1 326	4 385	9 321
Non responses	909	150	0	9	131	0	0	2
Usually work on Saturday	17 822	13 582	179	335	3 622	573	1 824	2 634
Sometimes work on Saturday	10 623	7 173	419	197	1 939	281	223	2 401
Never work on Saturday	35 158	27 246	1 084	708	9 470	610	2 847	5 138
Non responses	1 321	125	0	8	109	0	0	3
Usually work on Sunday	7 676	5 188	80	255	1 705	187	689	845
Sometimes work on Sunday	7 726	5 053	294	158	1 253	231	165	1 812
Never work on Sunday	48 193	37 753	1 309	825	12 067	1 045	4 041	7 517
Non responses	1 330	133	0	9	115	0	0	3
All in employment	64 925	48 127	1 682	1 248	15 141	1 463	4 895	10 177

⁽¹⁾ 1999, first quarter.⁽²⁾ 1998.⁽³⁾ 1997.⁽⁴⁾ Germany 1997, Greece 1998, Spain 1999-first quarter, Ireland 1997, Luxembourg 1998.⁽⁵⁾ Germany 1997, Spain 1999-first quarter, Ireland 1997, Luxembourg 1998.

Table 43

Persons working shift work, in the evening, at night, on Saturday or on Sunday

Thousands

IRL ⁽³⁾	I	L ⁽²⁾	NL	A	P	FIN	S	UK	
Males and Females									
134	2 796	17	570	512	276	465	848	2 328	Usually work shift work
54	615	(1)	50	97	.	.	61	363	Sometimes work shift work
1 179	11 371	136	6 106	2 566	3 223	1 545	2 484	18 022	Never work shift work
6	0	0	3	0	0	1	196	3 119	Non responses
159	2 677	16	1 290	544	.	564	855	8 350	Usually work in the evening
326	3 336	29	808	644	.	594	789	5 759	Sometimes work in the evening
884	14 588	126	5 507	2 489	4 830	1 172	2 161	11 455	Never work in the evening
4	15	0	0	0	0	3	248	1 543	Non responses
85	1 072	5	175	349	431	203	288	3 235	Usually work at night
197	1 596	17	647	357	.	214	234	2 654	Sometimes work at night
1 087	17 927	148	6 774	2 971	4 399	1 913	3 284	19 675	Never work at night
4	22	0	8	0	0	2	248	1 542	Non responses
416	7 941	32	2 062	974	1 419	586	753	6 814	Usually work on Saturday
404	4 429	40	1 165	863	.	306	819	7 670	Sometimes work on Saturday
549	8 229	98	4 375	1 840	3 411	1 438	2 234	9 584	Never work on Saturday
4	18	0	1	0	0	2	248	3 039	Non responses
235	1 717	14	1 156	559	579	416	683	3 494	Usually work on Sunday
251	2 911	25	813	525	.	237	736	6 248	Sometimes work on Sunday
883	15 970	131	5 635	2 594	4 251	1 677	2 386	14 327	Never work on Sunday
4	20	0	0	0	0	2	248	3 038	Non responses
1 373	20 618	171	7 605	3 678	4 830	2 333	4 054	27 107	All in employment
Males									
82	1 847	12	354	304	170	213	335	1 468	Usually work shift work
33	428	(1)	31	59	.	.	33	247	Sometimes work shift work
719	6 695	82	3 426	1 408	1 730	794	1 307	9 106	Never work shift work
4	0	0	2	0	0	1	107	1 740	Non responses
108	1 898	10	732	353	.	307	428	5 098	Usually work in the evening
245	2 460	21	458	435	.	352	451	3 721	Sometimes work in the evening
482	8 754	76	3 185	1 274	2 651	562	1 096	5 235	Never work in the evening
2	7	0	0	0	0	2	147	895	Non responses
57	812	4	115	241	288	120	173	2 230	Usually work at night
152	1 268	14	390	256	.	139	165	1 962	Sometimes work at night
627	11 027	89	3 862	1 566	2 363	962	1 638	9 862	Never work at night
2	10	0	6	0	0	2	147	895	Non responses
289	5 021	17	1 168	481	814	318	319	3 915	Usually work on Saturday
274	3 204	29	781	556	.	171	482	5 034	Sometimes work on Saturday
272	4 884	60	2 424	1 025	1 837	732	1 175	4 048	Never work on Saturday
2	9	0	1	0	0	1	147	1 952	Non responses
169	1 137	9	634	307	325	226	299	1 833	Usually work on Sunday
162	2 058	18	515	346	.	133	432	4 267	Sometimes work on Sunday
505	9 916	80	3 225	1 410	2 326	862	1 245	6 898	Never work on Sunday
2	8	0	0	0	0	1	147	1 952	Non responses
838	13 119	107	4 374	2 063	2 651	1 223	2 123	14 950	All in employment
Females									
52	949	4	216	208	106	252	513	860	Usually work shift work
21	186	.	19	38	.	.	28	117	Sometimes work shift work
460	4 675	55	2 680	1 158	1 494	750	1 177	8 915	Never work shift work
2	0	0	0	0	0	0	88	1 379	Non responses
51	780	6	558	191	.	257	427	3 252	Usually work in the evening
81	876	8	350	210	.	241	338	2 039	Sometimes work in the evening
401	5 834	50	2 322	1 215	2 179	610	1 065	6 220	Never work in the evening
1	8	0	0	0	0	0	101	647	Non responses
27	260	(1)	59	108	143	84	114	1 006	Usually work at night
45	328	4	257	102	.	74	68	692	Sometimes work at night
460	6 899	59	2 912	1 406	2 036	951	1 647	9 813	Never work at night
1	11	0	1	0	0	0	101	647	Non responses
127	2 920	15	895	493	604	269	434	2 899	Usually work on Saturday
129	1 225	11	384	307	.	135	337	2 636	Sometimes work on Saturday
277	3 345	38	1 951	815	1 575	705	1 059	5 536	Never work on Saturday
1	8	0	0	0	0	1	101	1 086	Non responses
66	580	5	522	252	254	190	385	1 661	Usually work on Sunday
88	853	7	298	179	.	104	304	1 980	Sometimes work on Sunday
379	6 054	52	2 410	1 184	1 925	815	1 141	7 429	Never work on Sunday
1	11	0	0	0	0	0	101	1 086	Non responses
535	7 499	64	3 231	1 615	2 179	1 109	1 931	12 157	All in employment

(1) 1999, first quarter.

(2) 1998.

(3) 1997.

(4) Germany 1997, Greece 1998, Spain 1999-first quarter, Ireland 1997, Luxembourg 1998.

(5) Germany 1997, Spain 1999-first quarter, Ireland 1997, Luxembourg 1998.

Table 44
Average actual weekly hours of work in main job, during the reference week, for all in employment

	EU-15 ⁽²⁾	EUR-11	B ⁽³⁾	DK	D	EL ⁽¹⁾	E	F
	<i>Hours</i>							
	Males and Females							
All in employment	37.9	38.3	36.8	35.5	38.1	41.7	39.5	38.9
Full-time	41.7	41.7	37.1	39.3	42.8	42.9	41.5	42.0
Part-time	19.5	19.9	21.0	20.1	18.1	20.8	17.9	23.2
All in self-employment	46.4	47.3	54.1	48.2	51.3	46.7	45.8	51.2
Full-time	49.7	50.2	.	50.7	55.8	48.2	47.2	53.2
Part-time	18.8	19.5	.	20.2	16.1	20.6	19.1	23.6
All Employees	36.4	36.6	34.0	34.3	36.7	38.8	38.0	37.3
Full-time	40.1	40.0	37.1	38.0	41.1	39.7	39.9	40.3
Part-time	19.6	20.0	21.0	20.1	18.3	20.5	17.7	23.3
	Males							
All in employment	41.5	41.5	40.3	38.2	42.4	43.5	41.4	42.1
Full-time	42.8	42.7	37.8	40.6	43.7	44.2	42.2	43.1
Part-time	19.3	20.1	21.1	14.6	16.0	22.0	18.9	23.8
All in self-employment	48.9	49.7	57.1	49.9	54.7	48.2	47.1	53.5
Full-time	50.5	51.1	.	51.8	57.0	49.1	47.8	54.3
Part-time	20.0	20.7	.	17.8	16.5	21.8	19.8	23.5
All Employees	39.8	39.7	37.1	36.5	40.6	40.0	39.8	40.2
Full-time	41.0	40.7	37.8	38.9	41.7	40.5	40.4	41.1
Part-time	19.1	20.0	21.1	14.3	16.0	21.6	18.9	23.9
	Females							
All in employment	32.9	33.5	32.0	32.1	32.4	38.5	36.1	34.7
Full-time	39.5	39.7	35.7	37.1	40.9	40.5	40.0	40.1
Part-time	19.6	19.9	21.0	22.0	18.4	20.2	17.6	23.0
All in self-employment	39.5	41.0	47.2	41.7	42.1	41.5	42.1	44.4
Full-time	46.6	47.2	.	45.9	51.8	44.5	45.1	49.2
Part-time	18.0	18.8	.	23.0	15.9	19.5	18.6	23.7
All Employees	32.1	32.6	29.8	31.6	31.8	36.9	35.0	33.9
Full-time	38.4	38.5	35.7	36.6	39.8	38.3	38.8	39.0
Part-time	19.7	20.0	21.0	22.0	18.6	19.9	17.4	23.1

⁽¹⁾ 1998.

⁽²⁾ Greece 1998.

⁽³⁾ Full-time/part-time data available only for Employees.

Table 44
Average actual weekly hours of work in main job, during the reference week, for all in employment

Hours									
IRL	I	L	NL	A	P	FIN	S	UK	
Males and Females									
39.0	39.1	39.0	31.7	39.6	39.6	37.5	36.3	36.2	All in employment
43.0	40.5	41.1	40.4	42.7	42.0	39.7	40.5	42.1	Full-time
18.8	22.9	21.5	18.3	22.9	20.1	21.0	23.9	17.6	Part-time
52.3	44.4	51.1	42.9	49.5	41.7	49.4	43.2	41.3	All in self-employment
54.8	45.7	53.3	55.4	53.6	48.4	52.4	48.1	47.4	Full-time
22.3	23.2	(23.7)	16.2	23.6	20.4	21.9	18.9	16.3	Part-time
36.2	37.3	37.9	30.3	38.2	39.0	35.7	35.5	35.6	All Employees
39.9	38.5	39.8	38.2	41.0	40.1	37.6	39.4	41.3	Full-time
18.4	22.8	21.4	18.5	23.0	19.8	21.2	24.3	17.8	Part-time
Males									
43.4	41.3	41.8	37.0	42.6	41.6	40.0	39.1	41.4	All in employment
45.3	41.8	42.1	41.1	43.4	43.0	41.5	41.4	43.7	Full-time
19.4	25.9	27.9	18.5	25.3	20.8	20.9	19.7	17.0	Part-time
54.5	45.7	54.0	50.0	52.7	44.5	51.5	44.9	45.2	All in self-employment
55.8	46.3	55.1	57.0	54.7	48.6	54.0	49.1	48.1	Full-time
25.1	26.0	.	17.4	26.0	20.7	24.9	17.8	17.9	Part-time
39.7	39.4	40.6	35.1	41.1	40.6	37.6	38.0	40.8	All Employees
41.5	39.8	40.7	38.7	41.7	41.0	38.9	40.0	42.9	Full-time
18.5	25.9	(29.4)	18.7	25.7	21.0	20.1	20.2	16.9	Part-time
Females									
32.4	35.2	34.5	24.3	35.4	37.2	34.6	33.1	29.6	All in employment
38.4	37.7	39.0	37.9	41.4	40.7	37.3	38.8	38.7	Full-time
18.5	21.7	20.7	18.2	22.5	19.8	21.1	25.0	17.7	Part-time
40.7	40.5	45.1	27.8	43.6	37.8	44.8	37.7	29.5	All in self-employment
48.1	43.5	48.9	47.9	51.0	48.0	49.0	44.2	43.6	Full-time
19.8	21.0	(22.4)	15.4	22.3	20.3	17.9	20.4	15.3	Part-time
31.8	33.9	33.7	24.0	34.3	37.1	33.6	32.8	29.6	All Employees
37.5	36.1	38.0	36.6	39.8	38.8	36.0	38.3	38.4	Full-time
18.4	21.9	20.7	18.4	22.6	19.5	21.6	25.4	18.0	Part-time

⁽¹⁾ 1998.

⁽²⁾ Greece 1998.

⁽³⁾ Full-time/part-time data available only for Employees.

Table 45

Average usual weekly hours of work in main job for all in employment

	EU-15 ⁽²⁾	EUR-11	B ⁽²⁾	DK	D	EL ⁽¹⁾	E	F
	Hours							
	Males and Females							
All in employment	37.9	37.9	37.2	35.8	37.2	43.1	40.2	37.7
Full-time	41.9	41.3	38.4	40.0	41.8	44.5	42.2	40.9
Part-time	19.5	19.8	21.7	19.6	17.7	21.4	18.2	22.9
All in self-employment	46.4	47.0	53.9	48.1	50.1	48.7	46.5	52.4
Full-time	50.0	50.1	.	50.8	54.8	50.3	47.9	54.9
Part-time	18.5	19.4	.	19.4	15.5	20.7	19.3	24.1
All Employees	36.5	36.3	35.1	34.7	35.8	39.9	38.7	36.6
Full-time	40.4	39.7	38.4	38.9	40.1	40.8	40.6	39.6
Part-time	19.6	19.9	21.7	19.6	17.9	21.3	18.0	22.9
	Males							
All in employment	41.5	41.0	40.6	38.5	41.1	45.0	42.1	40.7
Full-time	42.9	42.2	39.1	41.1	42.5	45.8	42.9	41.8
Part-time	19.0	19.9	21.6	13.6	15.3	22.4	19.1	23.3
All in self-employment	49.0	49.4	56.3	49.8	53.5	50.2	47.8	55.3
Full-time	50.9	51.0	.	51.9	55.9	51.2	48.5	56.3
Part-time	19.6	20.6	.	17.8	15.6	21.6	20.0	24.4
All Employees	39.8	39.2	38.3	36.9	39.4	41.2	40.5	39.3
Full-time	41.2	40.3	39.1	39.6	40.5	41.7	41.1	40.2
Part-time	18.9	19.8	21.6	13.3	15.3	22.5	19.1	23.2
	Females							
All in employment	33.2	33.5	32.6	32.7	32.1	39.9	36.7	34.2
Full-time	40.0	39.7	36.9	38.4	40.4	42.1	40.8	39.5
Part-time	19.6	19.8	21.7	21.6	18.1	20.8	17.9	22.9
All in self-employment	39.4	40.8	48.5	42.1	41.0	43.5	42.7	44.9
Full-time	47.1	47.3	.	46.6	51.0	46.7	46.0	50.5
Part-time	17.9	18.6	.	21.3	15.4	19.9	18.8	24.0
All Employees	32.4	32.6	30.9	32.3	31.5	37.9	35.7	33.6
Full-time	39.0	38.6	36.9	37.9	39.4	39.3	39.6	38.6
Part-time	19.8	19.9	21.7	21.6	18.3	20.6	17.8	22.9

(1) 1998.

(2) Greece 1998.

(3) Full-time/part-time data available only for Employees.

Table 45

Average usual weekly hours of work in main job for all in employment

Hours									
IRL	I	L	NL	A	P	FIN	S	UK	
Males and Females									
38.1	39.2	38.5	32.2	38.5	40.0	38.6	36.6	37.8	All in employment
42.1	40.5	40.6	41.0	41.9	42.4	41.0	41.3	44.4	Full-time
18.6	23.4	21.1	18.7	22.0	20.4	20.8	23.5	18.0	Part-time
51.6	44.6	50.4	42.8	48.8	42.0	49.1	44.4	42.5	All in self-employment
54.5	45.9	52.7	55.3	53.2	48.7	52.3	49.9	49.7	Full-time
21.4	23.9	(22.3)	16.2	21.8	20.7	19.5	19.2	16.2	Part-time
36.2	37.2	37.7	31.0	37.2	39.5	37.2	35.8	37.3	All Employees
40.0	38.5	39.7	39.0	40.2	40.6	39.3	40.1	43.6	Full-time
18.4	23.2	21.1	19.0	22.1	20.1	21.2	23.9	18.2	Part-time
Males									
42.3	41.3	41.4	37.4	41.2	42.0	40.8	39.3	43.5	All in employment
44.1	41.9	41.6	41.4	42.1	43.4	42.4	41.9	46.0	Full-time
19.0	26.7	27.5	19.0	22.3	21.3	20.2	18.7	16.9	Part-time
54.3	45.9	53.5	49.9	51.6	44.9	50.9	46.4	46.8	All in self-employment
55.7	46.6	54.6	57.0	53.8	48.9	53.6	51.0	50.3	Full-time
24.3	27.1	.	17.4	21.6	21.3	20.2	17.4	17.4	Part-time
39.6	39.3	40.4	35.7	39.7	41.0	38.8	38.1	42.9	All Employees
41.3	39.7	40.5	39.2	40.3	41.5	40.1	40.2	45.2	Full-time
18.5	26.6	(28.7)	19.3	22.9	21.2	20.4	19.1	16.9	Part-time
Females									
32.7	35.4	34.2	25.1	35.1	37.6	36.3	33.7	30.9	All in employment
38.6	37.9	38.6	39.3	41.5	41.1	39.3	40.4	41.0	Full-time
18.5	22.1	20.4	18.6	21.9	20.0	21.1	24.7	18.2	Part-time
40.1	40.7	43.8	27.9	43.8	38.0	45.4	38.5	30.1	All in self-employment
47.8	43.8	48.0	47.8	51.8	48.1	49.3	45.7	46.1	Full-time
19.4	21.4	(19.6)	15.5	21.8	20.4	18.6	21.5	15.5	Part-time
32.3	34.0	33.7	24.9	34.0	37.6	35.5	33.5	31.0	All Employees
38.0	36.3	38.0	38.3	39.9	39.4	38.3	39.9	40.7	Full-time
18.4	22.2	20.5	18.9	22.0	19.7	21.5	25.0	18.5	Part-time

(1) 1998.

(2) Greece 1998.

(3) Full-time/part-time data available only for Employees.

Table 46

Average usual weekly hours of work of self-employment by economic activity

Hours

	EU-15 ⁽²⁾	EUR-11	B	DK	D	EL ⁽¹⁾	E	F
Males and Females								
Agriculture (A-B)	49.5	49.7	67.0	52.5	61.5	46.1	50.3	54.4
Industry (C-F)	46.4	46.8	52.5	49.3	51.0	48.4	43.8	52.2
Mining and quarrying (C)							(48.8)	
Manufacturing (D)	46.7	47.0	51.7	49.4	51.1	51.0	44.4	54.0
Electricity, gaz, water supply (E)								
Construction (F)	46.3	46.6	52.7	49.2	50.9	44.8	43.2	50.6
Services (G-Q)	45.8	46.6	52.9	46.4	48.4	50.5	46.2	51.8
Wholesale and retail, repairs (G)	47.8	47.9	53.8	49.2	50.1	50.5	45.5	53.1
Hotels and restaurants (H)	56.3	57.0	69.1	51.0	59.7	60.4	56.3	65.9
Transports, communications (I)	49.6	49.6	59.7	54.6	54.4	56.6	48.5	55.6
Financial intermediation (J)	45.4	46.8	50.8		50.3	41.6	41.1	52.9
Real estate, business activit. (K)	43.9	45.0	49.9	44.5	47.5	46.9	43.8	48.9
Public administration (L)								
Other services (M-Q)	38.6	40.1	45.8	40.2	41.9	41.2	37.9	45.4
Males								
Agriculture (A-B)	52.6	53.0	67.0	52.0	62.9	48.4	51.4	59.0
Industry (C-F)	47.4	47.7	54.0	50.1	52.2	48.5	44.4	52.9
Mining and quarrying (C)							(49.4)	
Manufacturing (D)	48.5	48.6	54.5	51.1	53.3	51.8	45.7	55.4
Electricity, gaz, water supply (E)								
Construction (F)	46.6	46.8	53.4	49.4	51.4	44.8	43.3	50.9
Services (G-Q)	48.9	49.4	55.6	48.8	52.4	52.2	48.2	55.0
Wholesale and retail, repairs (G)	49.7	49.5	55.3	50.7	53.1	50.9	46.8	55.1
Hotels and restaurants (H)	58.8	59.0	73.3	52.8	62.8	62.0	58.1	67.8
Transports, communications (I)	50.8	50.6	59.6	55.0	56.3	56.9	49.1	57.5
Financial intermediation (J)	48.0	48.9	52.2		52.2	(46.5)	44.1	55.4
Real estate, business activit. (K)	46.6	47.5	51.8	45.9	50.8	48.5	45.2	51.8
Public administration (L)								
Other services (M-Q)	44.2	45.2	51.5	43.6	48.2	44.0	40.6	50.2
Females								
Agriculture (A-B)	40.8	41.1	66.6		52.1	38.8	46.3	39.8
Industry (C-F)	38.5	40.0	38.5	43.6	40.3	46.6	38.9	46.1
Mining and quarrying (C)								
Manufacturing (D)	38.8	40.1	38.2	43.7	39.8	46.6	38.8	46.3
Electricity, gaz, water supply (E)								
Construction (F)	37.0	39.8			41.9		38.3	(45.6)
Services (G-Q)	39.5	41.2	48.2	41.1	40.6	45.8	42.4	45.9
Wholesale and retail, repairs (G)	43.8	44.4	50.8	44.5	43.7	49.3	43.4	48.8
Hotels and restaurants (H)	52.1	53.5	64.4	(48.6)	55.2	54.8	52.6	62.1
Transports, communications (I)	39.2	41.5			44.7		36.9	(43.7)
Financial intermediation (J)	36.1	38.6			41.6		33.2	(47.7)
Real estate, business activit. (K)	36.2	37.8	44.5	39.8	37.9	42.7	40.1	41.4
Public administration (L)								
Other services (M-Q)	33.2	35.1	40.6	37.4	35.1	38.1	35.7	40.4

⁽¹⁾ 1998.⁽²⁾ Greece 1998.

Table 46

Average usual weekly hours of work of self-employment by economic activity

Hours									
IRL	I	L	NL	A	P	FIN	S	UK	
Males and Females									
60.9	45.9	59.0	51.9	54.1	37.0	54.3	46.0	55.2	Agriculture (A-B)
48.6	44.7	49.4	47.1	48.2	43.7	48.3	44.3	44.6	Industry (C-F)
	(37.7)								Mining and quarrying (C)
47.8	45.3		40.7	47.7	44.7	48.0	45.7	41.3	Manufacturing (D)
	44.3				44.3				Electricity, gaz, water supply (E)
49.1	44.1	(50.5)	51.9	49.7	42.8	48.3	43.2	45.7	Construction (F)
46.8	44.3	49.1	43.6	45.4	45.8	46.2	44.0	40.4	Services (G-Q)
50.6	46.4	52.3	50.5	46.2	46.9	49.8	46.2	46.2	Wholesale and retail, repairs (G)
58.6	49.7	(56.0)	54.8	52.7	61.5	56.3	57.7	48.3	Hotels and restaurants (H)
47.0	45.2		52.7	45.6	45.7	50.7	48.9	47.2	Transports, communications (I)
	42.3		48.1	43.0	38.4				Financial intermediation (J)
44.5	42.9	45.7	41.2	44.9	40.6	43.0	40.7	40.3	Real estate, business activit. (K)
	37.9								Public administration (L)
38.2	37.9	44.8	36.4	40.0	34.5	38.4	38.2	33.0	Other services (M-Q)
Males									
62.0	47.5	(63.3)	56.1	57.7	40.3	56.6	48.2	57.8	Agriculture (A-B)
49.4	45.3	(52.3)	49.8	49.5	44.5	49.1	44.9	46.1	Industry (C-F)
	(40.0)								Mining and quarrying (C)
49.7	46.4		44.5	49.2	46.9	48.3	46.4	46.0	Manufacturing (D)
	44.5				(46.9)				Electricity, gaz, water supply (E)
49.3	44.2	(50.7)	52.9	50.5	42.9	49.4	43.8	46.2	Construction (F)
50.5	45.8	51.4	50.1	48.8	48.9	47.9	46.4	45.8	Services (G-Q)
52.0	47.3	52.1	55.6	48.4	48.1	50.7	48.2	49.9	Wholesale and retail, repairs (G)
63.5	50.5		61.8	56.1	62.9	57.2	61.0	53.1	Hotels and restaurants (H)
48.4	45.8		55.4	49.1	46.8	51.3	50.0	49.2	Transports, communications (I)
	44.3		50.0		(40.1)				Financial intermediation (J)
47.0	44.7	(47.8)	45.0	48.4	43.9	43.5	41.9	44.0	Real estate, business activit. (K)
	38.2								Public administration (L)
47.3	40.6	(50.2)	45.7	44.7	41.1	38.5	40.9	40.7	Other services (M-Q)
Females									
(47.6)	40.9		31.5	49.6	34.2	49.6	36.7	42.1	Agriculture (A-B)
(40.5)	40.2		29.0	38.0	39.8	44.8	39.7	26.4	Industry (C-F)
									Mining and quarrying (C)
(39.7)	40.5		30.0	38.9	40.1	47.2		26.8	Manufacturing (D)
									Electricity, gaz, water supply (E)
	38.7							23.9	Construction (F)
38.9	40.7	45.1	31.9	39.2	42.0	43.3	38.6	30.0	Services (G-Q)
46.0	44.3	(52.6)	37.5	41.4	45.1	48.1	41.8	35.7	Wholesale and retail, repairs (G)
(51.5)	48.2		42.5	48.5	59.6	(55.4)		42.8	Hotels and restaurants (H)
	38.0		(44.3)	33.1				31.4	Transports, communications (I)
	35.0							22.1	Financial intermediation (J)
(36.2)	37.5	(40.2)	31.0	34.4	33.5	41.9	36.3	28.6	Real estate, business activit. (K)
	37.6								Public administration (L)
31.2	34.7	(37.6)	27.4	33.5	32.7	38.4	36.1	26.4	Other services (M-Q)

(1) 1998.

(2) Greece 1998.

Table 47

Average usual weekly hours of work of full-time employees by economic activity

Hours

	EU-15 ⁽²⁾	EUR-11	B	DK	D	EL ⁽¹⁾	E	F
Males and Females								
Agriculture (A-B)	42.6	42.1	38.8	42.6	42.1	47.6	43.3	40.3
Industry (C-F)	40.5	39.9	39.3	38.3	39.4	41.9	40.8	39.7
Mining and quarrying (C)	42.3	40.6	40.9	(46.7)	40.3	41.5	40.7	40.6
Manufacturing (D)	40.3	39.7	39.2	38.4	39.1	41.9	40.8	39.6
Electricity, gaz, water supply (E)	39.9	39.2	38.9	38.5	39.3	39.8	40.0	39.2
Construction (F)	41.1	40.5	39.6	37.9	40.3	42.4	40.9	40.0
Services (G-Q)	40.2	39.5	37.9	39.1	40.5	40.2	40.3	39.5
Wholesale and retail, repairs (G)	41.3	40.7	39.3	39.3	40.4	43.5	41.9	40.6
Hotels and restaurants (H)	43.2	43.0	39.6	41.2	43.6	47.1	43.8	43.2
Transports, communications (I)	42.0	40.9	40.6	40.6	41.9	44.6	41.8	40.3
Financial intermediation (J)	40.3	39.8	39.6	39.3	40.0	40.2	40.9	40.2
Real estate, business activit. (K)	41.3	40.5	39.8	39.4	41.1	41.3	40.5	40.9
Public administration (L)	39.2	38.8	38.5	38.6	39.7	39.5	38.7	39.8
Other services (M-Q)	38.6	37.7	34.8	38.4	40.2	35.1	38.4	37.5
Males								
Agriculture (A-B)	43.2	42.5	38.8	43.3	41.9	47.4	44.0	40.6
Industry (C-F)	40.8	40.0	39.4	38.6	39.5	42.2	40.9	39.8
Mining and quarrying (C)	42.5	40.7	40.9	(49.9)	40.4	41.6	40.7	40.7
Manufacturing (D)	40.6	39.8	39.3	38.9	39.2	42.3	41.0	39.8
Electricity, gaz, water supply (E)	40.0	39.3	39.0	38.5	39.4	40.0	40.0	39.4
Construction (F)	41.2	40.5	39.7	37.9	40.3	42.4	40.9	40.0
Services (G-Q)	41.4	40.5	38.9	40.1	41.5	41.2	41.1	40.5
Wholesale and retail, repairs (G)	42.1	41.3	39.5	40.4	41.2	43.9	42.2	41.4
Hotels and restaurants (H)	44.5	44.1	40.6	41.7	44.8	47.3	44.9	44.1
Transports, communications (I)	42.7	41.5	40.9	41.4	42.6	45.3	42.3	40.8
Financial intermediation (J)	41.3	40.5	40.6	40.6	40.9	40.4	41.2	41.6
Real estate, business activit. (K)	42.3	41.2	40.3	40.0	42.1	42.4	41.0	41.6
Public administration (L)	39.8	39.2	38.7	39.5	40.2	40.0	39.1	40.4
Other services (M-Q)	39.9	38.8	35.6	38.9	41.6	34.9	39.1	37.7
Females								
Agriculture (A-B)	41.0	40.9	.	39.2	42.4	48.0	40.7	39.3
Industry (C-F)	39.5	39.3	38.8	37.3	38.9	41.0	40.4	39.1
Mining and quarrying (C)	.	40.0	40.4	(40.1)
Manufacturing (D)	39.5	39.3	38.8	37.2	38.7	41.1	40.5	39.1
Electricity, gaz, water supply (E)	39.1	38.6	(38.3)	.	38.5	39.2	39.7	38.6
Construction (F)	39.7	39.8	38.7	38.0	39.9	.	40.2	39.9
Services (G-Q)	38.8	38.3	36.5	38.0	39.4	38.9	39.4	38.5
Wholesale and retail, repairs (G)	39.9	39.8	38.9	37.4	39.3	42.9	41.4	39.5
Hotels and restaurants (H)	41.9	41.8	38.6	40.7	42.6	46.9	42.5	41.8
Transports, communications (I)	39.6	39.0	38.9	38.2	39.7	41.3	39.6	38.6
Financial intermediation (J)	39.1	38.9	37.9	37.3	39.1	40.0	40.1	39.0
Real estate, business activit. (K)	39.8	39.6	39.0	38.4	39.6	40.4	39.9	40.0
Public administration (L)	38.3	38.0	38.1	37.2	39.0	38.5	38.0	38.9
Other services (M-Q)	37.9	37.0	34.2	38.2	39.3	35.3	38.0	37.4

⁽¹⁾ 1998.⁽²⁾ Greece 1998.

Table 47

Average usual weekly hours of work of full-time employees by economic activity

Hours

IRL	I	L	NL	A	P	FIN	S	UK	
Males and Females									
47.1	41.3	(42.8)	39.8	41.8	45.8	41.5	41.2	47.9	Agriculture (A-B)
40.7	40.4	40.4	39.1	39.6	41.1	39.7	39.8	44.1	Industry (C-F)
42.6	40.2	.	(42.4)	39.4	44.3	(40.8)	.	49.5	Mining and quarrying (C)
40.5	40.4	40.5	38.9	39.5	40.7	39.5	39.7	43.6	Manufacturing (D)
39.8	38.7	(39.3)	38.5	39.5	39.7	39.1	39.7	43.3	Electricity, gaz, water supply (E)
41.4	40.9	40.2	39.5	39.9	42.0	40.6	40.2	45.5	Construction (F)
39.4	37.2	39.4	38.9	40.5	40.0	39.0	40.3	43.3	Services (G-Q)
40.8	41.4	39.9	39.5	39.9	42.0	39.6	40.7	43.6	Wholesale and retail, repairs (G)
41.4	42.0	43.5	39.2	41.4	45.4	38.7	40.2	43.6	Hotels and restaurants (H)
41.2	40.0	40.4	39.9	40.7	41.8	40.8	39.7	46.2	Transports, communications (I)
39.9	39.0	40.6	38.4	39.8	38.6	39.5	39.8	42.1	Financial intermediation (J)
40.3	39.7	39.8	39.4	40.8	40.6	39.2	40.3	43.8	Real estate, business activit. (K)
39.5	36.8	39.4	37.8	40.5	38.6	38.3	39.9	41.5	Public administration (L)
36.7	33.3	37.7	38.5	40.7	37.6	38.4	40.4	42.8	Other services (M-Q)
Males									
48.0	42.0	.	40.0	41.3	47.4	42.4	41.5	48.9	Agriculture (A-B)
41.3	40.6	40.5	39.1	39.7	41.5	39.9	39.8	45.0	Industry (C-F)
42.9	40.1	.	(42.8)	39.5	44.8	.	.	50.7	Mining and quarrying (C)
41.1	40.6	40.6	38.9	39.6	41.1	39.6	39.7	44.6	Manufacturing (D)
40.1	38.7	(40.0)	38.5	39.5	39.8	39.4	39.6	44.1	Electricity, gaz, water supply (E)
41.5	41.0	40.3	39.5	39.9	42.0	40.7	40.2	46.1	Construction (F)
41.1	38.9	40.5	39.2	40.9	41.1	40.2	40.5	45.3	Services (G-Q)
42.2	42.0	40.8	39.8	40.3	42.4	40.8	41.1	45.4	Wholesale and retail, repairs (G)
43.9	43.5	45.2	39.2	42.1	47.7	40.3	40.2	46.0	Hotels and restaurants (H)
41.9	40.5	40.8	40.0	40.9	42.5	41.8	39.6	47.4	Transports, communications (I)
41.0	39.4	41.0	38.7	40.3	38.9	42.4	40.2	44.1	Financial intermediation (J)
41.5	40.7	41.2	39.6	41.4	41.9	39.7	40.6	45.5	Real estate, business activit. (K)
40.5	37.3	40.0	37.8	40.9	39.8	39.1	40.0	42.9	Public administration (L)
38.4	35.6	39.1	38.9	41.4	38.0	39.1	40.8	45.1	Other services (M-Q)
Females									
.	39.3	.	(38.1)	42.8	42.2	39.3	.	41.1	Agriculture (A-B)
39.1	39.7	39.2	38.6	39.3	40.2	39.0	39.6	40.3	Industry (C-F)
.	40.5	40.7	Mining and quarrying (C)
39.1	39.7	39.7	38.6	39.2	40.2	39.1	39.5	40.3	Manufacturing (D)
.	38.5	.	.	39.1	(37.8)	.	.	40.5	Electricity, gaz, water supply (E)
(38.8)	39.1	(38.1)	(39.1)	39.8	40.0	37.8	39.9	39.5	Construction (F)
37.7	35.1	37.8	38.3	40.0	39.0	38.1	40.0	40.8	Services (G-Q)
39.1	40.5	38.6	38.5	39.5	41.4	38.0	39.8	40.3	Wholesale and retail, repairs (G)
39.3	39.9	41.1	39.1	41.0	44.2	38.0	40.2	41.1	Hotels and restaurants (H)
39.3	37.7	38.8	38.9	40.1	39.3	38.2	39.8	41.9	Transports, communications (I)
39.0	38.1	39.7	37.6	39.0	37.8	38.1	39.4	39.7	Financial intermediation (J)
39.1	38.7	37.6	38.9	40.2	39.5	38.6	39.7	40.9	Real estate, business activit. (K)
37.7	35.6	37.6	37.4	39.8	36.4	37.4	39.9	39.3	Public administration (L)
35.8	31.9	36.6	38.0	40.3	37.5	38.2	40.2	41.4	Other services (M-Q)

(1) 1998.

(2) Greece 1998.

Table 48

Average usual weekly hours of work of part-time employees by economic activity

Hours

	EU-15 ⁽²⁾	EUR-11	B	DK	D	EL ⁽¹⁾	E	F
Males and Females								
Agriculture (A-B)	21.6	22.2	19.5	13.2	17.8	(26.8)	20.6	22.9
Industry (C-F)	20.4	20.6	23.8	16.0	17.4	25.0	20.1	25.5
Mining and quarrying (C)
Manufacturing (D)	20.4	20.5	23.8	15.5	17.5	23.7	20.1	25.5
Electricity, gaz, water supply (E)	23.0	23.1	.	.	19.4	.	.	27.5
Construction (F)	20.3	21.1	25.1	19.1	17.0	26.4	20.7	25.2
Services (G-Q)	19.6	19.9	21.5	20.1	18.0	20.2	17.8	22.7
Wholesale and retail, repairs (G)	18.9	19.8	22.2	15.0	17.8	22.7	20.7	24.9
Hotels and restaurants (H)	17.4	18.3	18.6	15.8	15.9	22.6	18.1	23.0
Transports, communications (I)	20.5	20.5	23.9	16.6	17.9	(22.1)	19.2	25.2
Financial intermediation (J)	21.4	21.9	25.4	24.2	19.2	(25.3)	17.5	26.0
Real estate, business activit. (K)	18.9	19.1	21.8	19.3	16.0	21.4	18.4	22.7
Public administration (L)	22.4	22.7	22.0	24.1	20.6	(23.1)	18.8	24.7
Other services (M-Q)	19.8	19.8	21.0	22.4	18.4	18.5	16.5	21.1
Males								
Agriculture (A-B)	22.3	23.0	.	(12.7)	16.2	(27.2)	19.7	22.9
Industry (C-F)	21.2	22.1	24.9	13.5	13.9	25.5	20.3	26.3
Mining and quarrying (C)
Manufacturing (D)	20.2	21.1	23.7	12.8	13.4	(23.9)	20.3	25.7
Electricity, gaz, water supply (E)
Construction (F)	23.3	24.1	(28.9)	.	15.5	26.4	20.7	27.7
Services (G-Q)	18.5	19.5	21.0	13.2	15.6	19.9	18.7	22.6
Wholesale and retail, repairs (G)	16.6	17.8	18.7	10.6	13.9	(24.0)	21.1	24.6
Hotels and restaurants (H)	17.1	17.7	22.5	(16.4)	15.1	(22.2)	17.7	22.7
Transports, communications (I)	20.3	20.2	22.8	11.7	16.1	.	18.9	26.6
Financial intermediation (J)	20.9	21.6	.	(17.6)	16.9	.	.	(26.5)
Real estate, business activit. (K)	18.4	19.1	(21.5)	11.6	14.5	.	19.5	23.4
Public administration (L)	22.1	22.8	22.2	(17.9)	18.2	.	20.1	23.1
Other services (M-Q)	18.9	19.8	19.8	15.0	16.4	16.7	17.4	20.5
Females								
Agriculture (A-B)	21.2	21.7	(19.0)	.	18.3	.	22.1	22.9
Industry (C-F)	20.2	20.1	23.4	17.4	18.1	(23.4)	19.8	25.2
Mining and quarrying (C)
Manufacturing (D)	20.4	20.3	23.8	17.1	18.2	(23.4)	19.9	25.4
Electricity, gaz, water supply (E)	.	21.9	.	.	20.0	.	.	26.1
Construction (F)	18.5	19.1	22.4	18.6	17.4	.	(20.7)	24.0
Services (G-Q)	19.8	20.0	21.6	22.1	18.4	20.3	17.6	22.7
Wholesale and retail, repairs (G)	19.4	20.1	22.7	17.2	18.2	22.2	20.5	24.9
Hotels and restaurants (H)	17.4	18.5	16.5	15.7	16.1	(23.2)	18.2	23.1
Transports, communications (I)	20.6	20.7	24.7	20.8	18.7	.	19.3	24.8
Financial intermediation (J)	21.5	21.9	25.3	26.8	19.4	.	16.7	26.0
Real estate, business activit. (K)	19.0	19.1	21.8	22.2	16.3	22.0	18.1	22.5
Public administration (L)	22.5	22.6	22.0	25.5	20.9	.	18.4	25.1
Other services (M-Q)	20.0	19.7	21.0	23.8	18.7	18.9	16.3	21.1

⁽¹⁾ 1998.⁽²⁾ Greece 1998.

Table 48

Average usual weekly hours of work of part-time employees by economic activity

Hours									
IRL	I	L	NL	A	P	FIN	S	UK	
Males and Females									
(19.6)	30.8	.	16.5	19.2	21.7	23.5	.	18.6	Agriculture (A-B)
22.0	25.6	(22.0)	22.0	22.4	21.1	19.9	22.8	19.4	Industry (C-F)
.	Mining and quarrying (C)
21.4	24.6	(22.5)	21.5	23.0	19.8	19.2	23.0	19.9	Manufacturing (D)
.	(25.6)	.	(26.4)	Electricity, gaz,water supply (E)
23.5	29.3	(21.4)	23.7	19.9	24.5	22.4	21.9	16.3	Construction (F)
18.0	22.1	21.0	19.9	22.0	19.8	21.2	24.1	18.1	Services (G-Q)
17.8	23.4	24.7	16.8	22.0	22.2	22.7	22.0	17.3	Wholesale and retail,repairs (G)
16.6	23.3	.	14.8	21.1	22.3	21.2	19.9	15.7	Hotels and restaurants (H)
21.2	23.1	(21.4)	20.2	20.5	(22.4)	20.4	21.5	20.7	Transports, communications (I)
19.2	24.0	(21.8)	23.3	21.4	.	(22.4)	24.7	19.8	Financial intermediation (J)
17.8	21.6	(20.6)	20.0	21.8	20.1	19.0	20.4	17.7	Real estate,business activit. (K)
19.5	22.0	(21.8)	25.5	22.6	19.0	23.1	26.0	20.6	Public administration (L)
18.4	21.0	19.4	20.9	22.6	18.8	21.0	25.4	18.7	Other services (M-Q)
Males									
.	31.7	.	16.7	.	24.0	.	.	18.8	Agriculture (A-B)
23.4	31.4	.	24.5	25.0	22.7	21.3	18.8	18.0	Industry (C-F)
.	Mining and quarrying (C)
(21.8)	30.5	.	23.8	26.2	(19.5)	19.9	19.0	17.6	Manufacturing (D)
.	Electricity, gaz,water supply (E)
24.7	32.2	.	26.1	21.0	24.9	(24.5)	.	19.0	Construction (F)
17.3	24.0	(28.4)	20.0	22.2	20.1	20.0	19.2	16.7	Services (G-Q)
16.0	26.8	.	13.9	22.2	21.2	19.4	16.2	15.6	Wholesale and retail,repairs (G)
14.3	28.7	.	13.7	18.3	21.6	19.1	20.3	15.8	Hotels and restaurants (H)
.	24.8	.	20.2	21.2	.	21.2	20.5	21.6	Transports, communications (I)
.	.	.	(24.1)	Financial intermediation (J)
(19.4)	24.3	.	19.8	23.6	.	21.1	16.6	17.3	Real estate,business activit. (K)
.	22.0	.	28.3	17.4	Public administration (L)
19.1	22.4	.	24.8	23.2	16.4	19.3	19.4	17.0	Other services (M-Q)
Females									
.	30.1	.	16.3	18.1	(18.8)	(23.3)	.	18.5	Agriculture (A-B)
21.0	23.0	(19.4)	19.9	21.7	20.0	18.1	25.5	19.8	Industry (C-F)
.	Mining and quarrying (C)
21.2	23.2	.	19.8	22.1	19.8	18.6	25.5	20.6	Manufacturing (D)
.	Electricity, gaz,water supply (E)
.	21.7	.	20.2	19.4	.	.	.	15.4	Construction (F)
18.2	21.6	20.5	19.9	22.0	19.7	21.7	25.0	18.4	Services (G-Q)
18.4	22.6	23.0	17.9	22.0	22.8	23.4	23.1	17.8	Wholesale and retail,repairs (G)
17.3	22.2	.	15.4	21.5	22.7	21.9	19.8	15.6	Hotels and restaurants (H)
(20.7)	22.0	(21.4)	20.1	20.2	.	19.4	22.6	20.1	Transports, communications (I)
19.5	23.4	(21.7)	23.2	21.3	.	(24.0)	25.1	19.9	Financial intermediation (J)
17.4	21.2	(19.4)	20.1	21.5	20.0	17.8	22.2	17.8	Real estate,business activit. (K)
19.1	21.9	(21.4)	24.3	22.7	(17.0)	23.3	25.1	21.2	Public administration (L)
18.3	20.7	19.4	20.3	22.5	19.0	21.5	26.1	18.9	Other services (M-Q)

(1) 1998.

(2) Greece 1998.

Table 49

Average usual weekly hours of work of self-employment by occupation

Hours

	EU-15 ⁽³⁾	EUR-11 ⁽⁴⁾	B	DK	D	EL ⁽¹⁾	E	F
Males and Females								
Legislators and managers (1)	50.8	51.1	57.1	50.4	53.4	53.1	48.5	55.0
Professionals (2)	42.5	43.4	49.4	42.3	45.8	42.9	40.3	48.3
Technicians (3)	43.0	44.1	46.0	43.8	46.7	44.4	42.1	44.7
Clerks (4)	33.9	39.2	.	.	44.7	51.0	41.4	.
Services and sales workers (5)	44.7	45.4	42.5	42.7	41.7	47.4	43.9	43.6
Agriculture/ fishery workers (6)	49.4	49.9	67.0	52.9	61.5	46.0	50.6	54.2
Craft/related trades workers (7)	46.7	46.9	56.8	49.7	51.2	48.0	43.6	52.6
Plant and machine operators (8)	48.0	47.5	62.3	50.0	50.8	54.9	47.4	55.4
Elementary occupations (9)	37.7	39.3	(50.9)	(43.2)	41.0	45.7	41.4	.
Armed forces (0)
Males								
Legislators and managers (1)	53.1	53.1	57.9	51.0	55.9	54.0	50.1	57.0
Professionals (2)	45.9	46.9	52.2	43.0	49.7	45.3	43.7	52.2
Technicians (3)	46.1	46.8	49.1	52.5	50.9	46.0	43.5	49.7
Clerks (4)	43.6	46.0	.	.	52.0	(54.2)	44.7	.
Services and sales workers (5)	48.5	48.5	45.7	(47.3)	50.6	50.1	47.3	46.7
Agriculture/ fishery workers (6)	52.5	53.3	67.1	52.3	63.4	48.4	51.6	58.7
Craft/related trades workers (7)	47.2	47.5	57.6	49.3	52.0	48.1	44.1	53.3
Plant and machine operators (8)	49.2	48.7	62.9	55.9	52.8	55.2	48.2	57.8
Elementary occupations (9)	43.9	44.1	.	(44.9)	45.9	49.7	43.8	.
Armed forces (0)
Females								
Legislators and managers (1)	45.5	46.5	55.4	48.2	47.6	50.5	45.5	51.2
Professionals (2)	34.7	35.9	42.9	40.3	36.6	38.5	33.9	41.0
Technicians (3)	35.0	36.4	40.8	34.8	37.5	39.8	37.3	39.6
Clerks (4)	28.5	33.7	.	.	36.0	(45.9)	35.5	.
Services and sales workers (5)	41.3	42.4	40.6	39.5	37.3	44.7	42.1	42.3
Agriculture/ fishery workers (6)	41.0	41.4	66.6	.	51.4	38.7	47.0	39.7
Craft/related trades workers (7)	39.4	40.1	.	.	40.6	47.0	36.8	45.6
Plant and machine operators (8)	36.8	37.7	.	(32.3)	38.7	.	39.8	(40.9)
Elementary occupations (9)	28.7	32.4	.	.	31.1	38.8	36.5	.
Armed forces (0)

⁽¹⁾ 1998.⁽²⁾ 1997.⁽³⁾ Greece 1998, Ireland 1997.⁽⁴⁾ Ireland 1997.

Table 49

Average usual weekly hours of work of self-employment by occupation

Hours									
IRL ⁽²⁾	I	L	NL	A	P	FIN	S	UK	
Males and Females									
56.9	46.3	53.2	50.2	50.3	49.8	50.2	49.8	47.8	Legislators and managers (1)
42.7	41.0	47.1	36.3	44.2	38.8	38.5	42.3	39.2	Professionals (2)
47.0	43.5	(40.9)	38.1	39.5	42.4	41.4	39.9	37.8	Technicians (3)
.	37.5	.	(19.2)	36.4	37.5	(34.4)	.	23.5	Clerks (4)
50.4	46.8	(45.8)	24.6	44.8	47.2	45.9	45.4	33.7	Services and sales workers (5)
62.3	46.0	59.0	(40.0)	54.0	36.6	54.2	46.5	52.3	Agriculture/ fishery workers (6)
48.6	44.9	(49.8)	47.4	47.4	42.9	47.0	43.1	45.7	Craft/related trades workers (7)
50.0	44.9	.	46.1	46.8	46.1	50.7	46.6	47.4	Plant and machine operators (8)
50.6	40.6	.	29.5	30.8	33.9	(45.3)	.	32.6	Elementary occupations (9)
.	Armed forces (0)
Males									
59.2	47.4	54.1	55.2	51.8	50.4	50.8	52.2	52.8	Legislators and managers (1)
47.3	42.7	50.6	42.3	47.3	43.6	39.4	44.4	43.1	Professionals (2)
49.5	45.1	.	45.9	44.2	43.9	42.9	41.6	42.5	Technicians (3)
.	43.1	32.6	Clerks (4)
54.4	48.4	.	(35.6)	49.4	50.1	(52.6)	52.6	43.8	Services and sales workers (5)
63.0	47.4	(63.6)	(53.3)	57.7	39.7	56.6	48.9	53.6	Agriculture/ fishery workers (6)
49.0	45.3	(50.7)	50.2	48.5	43.6	48.0	43.3	46.4	Craft/related trades workers (7)
50.9	45.8	.	52.5	47.8	47.0	51.4	46.8	48.7	Plant and machine operators (8)
52.2	44.4	.	(35.2)	28.4	42.6	.	.	42.5	Elementary occupations (9)
.	Armed forces (0)
Females									
52.0	41.3	(51.5)	35.3	45.8	48.5	48.3	43.8	38.3	Legislators and managers (1)
32.8	36.6	(36.6)	26.1	35.8	32.2	37.4	37.1	28.2	Professionals (2)
.	36.5	.	27.4	30.7	37.6	38.7	34.8	29.3	Technicians (3)
.	34.4	.	(12.8)	31.1	37.7	(35.2)	.	21.1	Clerks (4)
43.5	44.7	.	21.4	40.5	45.5	44.7	39.9	31.0	Services and sales workers (5)
52.3	41.2	.	.	49.4	34.0	49.5	35.3	39.0	Agriculture/ fishery workers (6)
.	41.6	.	(26.0)	.	38.8	(39.9)	.	29.7	Craft/related trades workers (7)
.	37.1	29.5	Plant and machine operators (8)
.	33.8	.	(23.9)	.	29.9	.	.	18.4	Elementary occupations (9)
.	Armed forces (0)

⁽¹⁾ 1998.

⁽²⁾ 1997.

⁽³⁾ Greece 1998, Ireland 1997.

⁽⁴⁾ Ireland 1997.

Table 50

Average usual weekly hours of work of full-time employees by occupation

Hours

	EU-15 ⁽²⁾	EUR-11 ⁽⁴⁾	B	DK	D	EL ⁽¹⁾	E	F
	Males and Females							
Legislators and managers (1)	44.7	43.3	42.5	44.8	44.3	42.3	43.6	45.2
Professionals (2)	39.4	38.0	34.7	39.2	41.4	33.3	38.0	38.2
Technicians (3)	39.7	39.3	39.7	38.8	39.5	41.0	40.6	39.1
Clerks (4)	39.2	39.0	38.7	37.4	39.5	40.4	39.8	38.7
Services and sales workers (5)	41.0	40.7	38.9	39.2	40.6	44.3	41.9	40.6
Agriculture/ fishery workers (6)	41.6	41.5	38.8	42.6	41.1	46.6	44.9	39.7
Craft/related trades workers (7)	40.3	39.7	38.8	37.5	39.1	42.1	40.8	39.3
Plant and machine operators (8)	41.2	40.5	39.5	38.6	40.7	43.4	41.7	39.5
Elementary occupations (9)	40.1	39.7	38.1	37.8	39.7	42.4	40.4	39.2
Armed forces (0)	42.0	41.6	40.0	40.6	41.3	40.5	40.2	47.4
	Males							
Legislators and managers (1)	45.6	43.8	43.0	45.4	44.9	42.4	43.8	46.8
Professionals (2)	40.9	39.8	36.2	39.7	41.9	35.0	39.0	40.0
Technicians (3)	40.5	40.0	39.9	40.3	40.1	42.4	41.2	39.8
Clerks (4)	39.9	39.4	39.3	38.1	40.0	40.6	40.2	39.0
Services and sales workers (5)	42.3	41.7	39.1	40.1	42.4	44.7	42.6	41.3
Agriculture/ fishery workers (6)	41.9	41.8	38.9	43.2	41.3	46.5	45.2	39.8
Craft/related trades workers (7)	40.4	39.8	38.9	37.5	39.2	42.2	40.8	39.4
Plant and machine operators (8)	41.6	40.7	39.8	39.2	41.0	43.9	41.9	39.8
Elementary occupations (9)	40.6	40.1	38.4	38.1	40.1	42.1	40.7	39.3
Armed forces (0)	42.0	41.5	40.1	41.0	41.3	40.5	40.2	47.8
	Females							
Legislators and managers (1)	42.2	41.4	41.3	42.6	42.1	41.8	42.2	42.2
Professionals (2)	37.4	35.4	33.0	38.4	40.5	31.4	37.0	35.0
Technicians (3)	38.7	38.5	39.2	37.4	39.0	39.4	39.6	38.2
Clerks (4)	38.7	38.7	38.1	37.0	39.1	40.2	39.5	38.6
Services and sales workers (5)	39.9	40.0	38.8	38.8	39.6	43.8	41.2	40.3
Agriculture/ fishery workers (6)	40.5	40.5	.	39.7	40.7	(47.1)	41.7	39.4
Craft/related trades workers (7)	39.4	39.3	38.2	37.0	38.6	41.3	40.5	38.4
Plant and machine operators (8)	39.3	39.2	37.8	36.8	38.6	40.8	40.5	38.5
Elementary occupations (9)	39.1	39.1	37.1	37.2	38.9	42.6	39.9	39.0
Armed forces (0)	.	42.3	.	.	.	40.8	.	44.0

⁽¹⁾ 1998.⁽²⁾ 1997.⁽³⁾ Greece 1998, Ireland 1997.⁽⁴⁾ Ireland 1997.

Table 50

Average usual weekly hours of work of full-time employees by occupation

Hours									
IRL ⁽²⁾	I	L	NL	A	P	FIN	S	UK	
Males and Females									
43.2	42.2	43.8	39.3	42.0	43.0	42.5	42.5	46.4	Legislators and managers (1)
38.1	30.1	38.3	39.1	41.0	36.5	38.5	41.2	44.5	Professionals (2)
41.2	38.6	39.6	38.7	40.3	38.5	39.1	40.0	42.6	Technicians (3)
38.5	38.4	39.6	38.5	39.5	39.0	37.7	39.8	39.9	Clerks (4)
40.1	40.1	40.6	38.8	40.5	42.7	39.2	39.5	42.0	Services and sales workers (5)
(52.0)	42.2	40.2	38.8	41.3	46.3	39.7	41.1	41.2	Agriculture/ fishery workers (6)
40.6	40.5	40.2	39.1	39.5	41.0	39.7	39.9	44.4	Craft/related trades workers (7)
41.8	40.4	40.5	39.6	40.1	41.6	40.5	39.2	45.2	Plant and machine operators (8)
40.8	39.4	38.3	38.9	40.5	40.6	38.7	39.3	42.8	Elementary occupations (9)
	38.3		39.4		41.2	38.6	39.9	45.9	Armed forces (0)
Males									
44.1	42.6	44.6	39.5	42.4	43.9	43.4	43.0	47.9	Legislators and managers (1)
40.3	34.2	39.8	39.2	41.4	38.1	39.4	41.2	45.0	Professionals (2)
42.4	39.5	40.6	39.0	40.5	40.4	40.0	40.2	44.2	Technicians (3)
39.8	38.7	40.0	38.6	39.7	39.7	38.3	39.8	42.1	Clerks (4)
42.4	40.7	42.2	39.2	41.1	44.2	40.2	40.1	45.1	Services and sales workers (5)
(52.3)	42.4	40.7	38.8	40.9	47.5	40.8	41.4	41.4	Agriculture/ fishery workers (6)
41.0	40.7	40.2	39.1	39.5	41.3	39.7	40.0	44.7	Craft/related trades workers (7)
42.3	40.6	40.6	39.7	40.3	42.1	40.7	39.2	46.0	Plant and machine operators (8)
41.2	40.1	40.2	39.0	40.7	41.3	39.1	39.2	44.0	Elementary occupations (9)
	38.3		39.5		41.1	38.6	39.9	46.1	Armed forces (0)
Females									
40.9	40.0	(41.3)	38.3	40.9	40.7	40.3	40.9	43.0	Legislators and managers (1)
36.0	27.6	35.6	38.7	40.6	35.2	37.8	41.1	43.7	Professionals (2)
38.9	37.3	38.0	38.0	40.1	36.5	38.2	39.7	40.3	Technicians (3)
37.9	38.0	39.1	38.4	39.3	38.5	37.6	39.8	38.7	Clerks (4)
38.5	39.3	39.4	38.0	40.0	41.9	38.8	39.2	39.2	Services and sales workers (5)
	41.2		(37.8)	42.3	42.4	38.1			Agriculture/ fishery workers (6)
39.0	39.5		38.6	39.4	40.3	39.0	39.4	39.7	Craft/related trades workers (7)
39.4	39.7	(39.2)	38.3	39.3	40.1	39.3	39.2	40.7	Plant and machine operators (8)
38.2	37.9	36.6	38.5	40.2	39.9	38.3	39.4	39.2	Elementary occupations (9)
									Armed forces (0)

(1) 1998.

(2) 1997.

(3) Greece 1998, Ireland 1997.

(4) Ireland 1997.

Table 51

Average usual weekly hours of work of part-time employees by occupation

Hours

	EU-15 ⁽³⁾	EUR-11 ⁽⁴⁾	B	DK	D	EL ⁽¹⁾	E	F
Males and Females								
Legislators and managers (1)	22.1	23.0	26.7	16.0	18.9	.	17.8	29.3
Professionals (2)	20.7	20.6	20.9	20.6	19.5	16.5	18.1	20.5
Technicians (3)	21.6	21.5	22.6	24.2	20.2	18.8	19.5	24.3
Clerks (4)	20.7	21.2	24.2	21.7	18.5	23.5	20.5	25.2
Services and sales workers (5)	19.0	19.6	21.7	19.6	18.0	22.9	18.7	23.1
Agriculture/ fishery workers (6)	20.2	20.6	17.3	.	18.1	.	19.8	23.0
Craft/related trades workers (7)	21.5	21.7	23.3	22.4	18.1	25.6	20.6	24.3
Plant and machine operators (8)	20.9	20.9	22.9	13.5	16.3	24.4	19.0	24.5
Elementary occupations (9)	16.6	16.8	18.7	14.1	14.4	20.8	16.3	19.0
Armed forces (0)
Males								
Legislators and managers (1)	20.8	22.9	24.3	11.9	17.3	.	.	28.6
Professionals (2)	19.8	20.5	19.0	19.2	18.2	14.9	17.9	19.7
Technicians (3)	20.4	21.2	24.2	12.1	17.4	17.7	19.1	22.6
Clerks (4)	18.5	18.9	20.9	12.9	15.0	.	19.7	22.4
Services and sales workers (5)	17.3	18.7	22.5	13.3	14.6	23.3	19.4	23.8
Agriculture/ fishery workers (6)	20.7	21.4	.	.	17.4	.	19.1	22.5
Craft/related trades workers (7)	22.7	23.3	22.3	18.4	16.6	25.8	20.2	25.1
Plant and machine operators (8)	20.8	21.1	20.7	12.5	14.2	.	18.3	24.3
Elementary occupations (9)	16.5	17.4	21.2	11.7	12.4	23.8	19.2	23.1
Armed forces (0)
Females								
Legislators and managers (1)	22.6	23.1	27.5	.	19.6	.	.	29.5
Professionals (2)	21.0	20.6	21.0	21.4	19.8	16.9	18.1	20.7
Technicians (3)	21.8	21.6	22.3	26.3	20.5	19.6	19.6	24.7
Clerks (4)	20.9	21.4	24.5	23.5	18.7	23.5	20.6	25.5
Services and sales workers (5)	19.2	19.7	21.6	20.6	18.2	22.8	18.6	23.0
Agriculture/ fishery workers (6)	19.8	19.9	19.2	.	18.4	.	.	24.2
Craft/related trades workers (7)	20.3	20.0	25.8	27.5	18.9	.	21.1	23.0
Plant and machine operators (8)	20.9	20.6	24.9	.	17.9	.	19.8	24.8
Elementary occupations (9)	16.7	16.7	18.5	15.6	14.8	19.9	16.0	18.4
Armed forces (0)

⁽¹⁾ 1998.⁽²⁾ 1997.⁽³⁾ Greece 1998, Ireland 1997.⁽⁴⁾ Ireland 1997.

Table 51

Average usual weekly hours of work of part-time employees by occupation

Hours									
IRL ⁽²⁾	I	L	NL	A	P	FIN	S	UK	
Males and Females									
.	26.5	.	22.4	22.4	.	19.0	.	21.3	Legislators and managers (1)
17.9	20.0	19.7	22.9	22.7	18.5	19.1	25.3	20.6	Professionals (2)
19.2	23.2	21.0	21.6	23.1	19.1	20.6	25.1	20.3	Technicians (3)
20.0	22.8	21.4	19.9	22.2	22.5	21.2	23.0	19.4	Clerks (4)
17.4	22.9	22.8	16.9	21.9	22.0	23.4	24.7	16.8	Services and sales workers (5)
.	28.7	.	17.5	.	22.2	22.7	.	16.6	Agriculture/ fishery workers (6)
22.2	26.6	32.7	21.1	22.2	20.4	24.8	19.1	20.6	Craft/related trades workers (7)
19.8	26.1	.	21.2	22.1	.	21.3	23.7	20.4	Plant and machine operators (8)
17.8	22.6	19.2	13.3	20.9	19.1	18.1	20.5	15.7	Elementary occupations (9)
.	Armed forces (0)
Males									
.	.	.	24.3	22.8	.	.	.	18.4	Legislators and managers (1)
16.0	19.4	.	25.0	24.5	16.4	17.7	19.7	17.2	Professionals (2)
.	24.2	.	23.6	23.3	21.0	18.0	20.3	17.9	Technicians (3)
.	23.4	.	17.5	20.8	21.7	20.9	16.1	18.6	Clerks (4)
17.0	26.5	.	15.8	20.3	20.7	21.6	19.5	15.8	Services and sales workers (5)
.	29.3	.	18.9	.	24.0	23.9	.	.	Agriculture/ fishery workers (6)
22.5	29.5	.	24.4	23.1	25.0	25.2	18.6	19.9	Craft/related trades workers (7)
.	29.6	.	23.6	25.0	.	22.7	22.3	19.7	Plant and machine operators (8)
20.6	27.8	.	11.8	23.1	21.6	18.5	14.5	15.2	Elementary occupations (9)
.	Armed forces (0)
Females									
.	.	.	21.2	22.2	.	.	.	22.1	Legislators and managers (1)
18.3	20.2	19.4	22.2	22.2	20.0	19.9	27.0	21.2	Professionals (2)
.	22.9	20.3	21.2	23.1	17.3	21.5	26.2	20.7	Technicians (3)
20.0	22.7	21.4	20.2	22.3	22.7	21.4	23.9	19.5	Clerks (4)
17.5	22.3	22.7	17.1	22.0	22.6	23.7	25.2	17.0	Services and sales workers (5)
.	27.7	.	15.9	.	19.9	21.5	.	.	Agriculture/ fishery workers (6)
21.8	23.1	.	13.4	21.4	18.3	23.8	.	21.0	Craft/related trades workers (7)
.	24.0	.	16.7	20.6	.	18.3	26.2	21.0	Plant and machine operators (8)
15.7	20.8	19.1	14.1	20.8	18.9	17.9	22.1	15.9	Elementary occupations (9)
.	Armed forces (0)

⁽¹⁾ 1998.

⁽²⁾ 1997.

⁽³⁾ Greece 1998, Ireland 1997.

⁽⁴⁾ Ireland 1997.

Table 52

Main characteristics of employment by region, for the population aged 15 to 64 years

REGION	EMPLOY- MENT AGE 15-64 (Rate)	EMPLOY- MENT AGE 15-24 (Rate)	EMPLOY- MENT AGE 25-49 (Rate)	EMPLOY- MENT AGE 50-64 (Rate)	EMPLOYM. NATI. (Rate)	EMPLOYM. EU-NATI. (Rate)	EMPLOYM. NON-EU - NON-NATI. (Rate)	SELF- EMPLOY- MENT (% all in Emp.)
BELGIQUE-BELGIE	58.9	25.5	79.2	38.5	60.5	56.4	27.5	14.8
Bruxelles-Cap-BrusselsHf.gewest	53.6	18.3	68.7	44.4	56.8	62.0	32.2	15.3
Antwerpen	59.9	25.7	81.3	37.3	61.8	64.3	24.3	13.5
Limburg (B)	57.9	28.5	79.7	30.8	59.1	50.4	(28.0)	14.5
Oost-Vlaanderen	62.4	34.3	83.2	37.0	63.4	81.2	24.0	17.2
Vlaams Brabant	65.9	25.8	89.1	42.3	66.3	67.1	43.0	11.1
West-Vlaanderen	63.8	31.9	87.1	38.7	64.1	.	.	15.9
Brabant Wallon	60.0	22.8	79.0	47.1	60.4	62.1	.	17.5
Hainaut	50.5	18.1	68.7	33.8	52.7	45.9	.	14.0
Liège	56.6	23.4	74.9	40.3	57.7	53.4	.	16.2
Luxemburg (B)	60.3	26.4	79.4	43.0	60.5	59.2	.	14.7
Namur	57.4	18.3	78.1	40.7	57.7	58.6	.	14.5
DANMARK	76.5	66.0	85.3	65.5	77.2	79.7	45.0	8.3
DEUTSCHLAND	64.8	46.2	79.1	48.2	65.9	67.1	50.0	10.0
Stuttgart	69.8	51.5	82.2	55.7	71.3	68.5	58.7	9.2
Karlsruhe	67.3	44.2	81.2	53.4	68.7	64.2	56.0	10.0
Freiburg	67.6	43.4	80.9	55.4	68.7	65.8	54.0	11.0
Tübingen	69.2	48.6	82.5	54.8	70.0	65.1	61.9	10.7
Oberbayern	71.8	53.8	85.2	56.7	72.3	74.7	65.3	13.9
Niederbayern	70.2	60.9	83.2	48.7	70.9	.	54.7	11.6
Oberplatz	69.5	54.4	82.8	50.9	69.7	.	61.8	10.8
Oberfranken	69.0	52.2	82.4	51.7	70.3	.	42.9	9.0
Mittelfranken	68.4	50.3	82.6	51.5	69.8	67.5	54.9	11.5
Unterfranken	67.5	48.9	82.0	49.9	68.3	67.7	55.8	10.0
Schwaben	70.9	54.0	83.7	54.7	71.6	78.6	58.9	10.3
Berlin-West, Stadt	57.6	33.1	70.5	46.1	61.3	64.0	38.7	13.0
Berlin-Ost, Stadt	64.4	47.3	76.9	49.0	65.6	.	46.0	9.3
Brandenburg	62.7	45.0	79.8	42.6	62.8	.	.	8.6
Bremen	59.8	40.7	72.4	48.3	61.6	.	46.0	9.2
Hamburg	65.8	44.1	76.5	56.5	68.5	62.5	49.4	12.0
Darmstadt	67.0	45.4	79.7	53.2	69.2	66.3	52.0	11.3
Gießen	63.7	42.5	78.4	47.9	65.0	70.5	45.5	11.2
Kassel	63.9	45.4	77.8	46.5	65.1	.	42.8	8.9
Mecklenburg-Vorpommern	61.0	50.3	76.1	40.4	61.1	.	.	6.7
Braunschweig	62.1	43.8	76.3	46.2	63.1	68.5	41.7	7.5
Hannover	64.3	43.1	77.8	48.2	65.5	69.3	48.1	9.2
Lüneburg	65.1	42.9	79.1	51.7	65.8	81.3	42.8	10.1
Weser-Ems	64.1	45.5	77.6	48.8	65.0	58.8	43.9	10.8
Düsseldorf	61.4	41.1	76.7	44.3	63.5	63.1	43.3	10.4
Köln	62.5	43.3	76.8	46.3	64.1	65.2	47.9	9.9
Münster	61.1	45.1	76.1	40.8	63.0	65.5	38.5	8.4
Detmold	65.1	44.0	79.5	50.2	66.2	59.2	52.3	8.5
Arnsberg	60.9	40.3	76.6	42.9	62.4	67.6	44.7	8.2
Koblenz	63.9	45.6	80.6	44.5	64.2	81.8	52.4	8.8
Trier	63.7	47.8	77.4	45.3	64.7	.	.	9.6
Rheinhausen-Pfalz	66.3	45.2	81.2	48.3	67.3	63.6	54.0	10.7
Saarland	60.9	42.6	78.0	38.7	62.3	55.0	40.1	9.6
Sachsen	63.7	49.4	79.7	43.2	63.8	.	49.6	9.2
Dessau	58.7	47.4	75.3	38.1	58.9	.	.	7.7
Halle	57.6	44.0	72.5	38.9	57.7	.	.	6.3
Magdeburg	61.3	50.1	76.6	40.8	61.5	.	.	7.6
Schleswig-Holstein	65.7	46.8	79.1	51.2	66.6	67.2	46.3	10.8
Thüringen	64.8	47.9	82.2	43.3	64.9	.	.	7.6
ELLADA ⁽²⁾	55.6	28.1	71.8	45.9	55.3	51.2	66.7	32.5
Anatoliki Makedonia, Thraki	59.9	42.2	73.9	48.9	59.9	.	63.1	35.9
Kentriki Makedonia	54.1	26.7	70.9	44.7	53.8	.	65.5	35.5
Dytiki Makedonia	55.1	27.2	68.6	47.4	55.1	.	.	39.2
Thessalia	57.2	26.2	72.2	52.3	57.1	.	(64.3)	38.1
Ipeiros	51.1	17.4	70.2	45.1	51.1	.	.	41.2
Ionia Nisia	62.9	32.1	75.3	60.7	62.4	.	76.6	42.3
Dytiki Ellada	55.5	24.8	70.3	53.0	55.4	.	64.1	38.6
Sterea Ellada	53.0	27.7	67.5	47.7	53.0	.	.	41.4

(1) Only Employees.

(2) 1998.

Table 52

Main characteristics of employment by region, for the population aged 15 to 64 years

EMPLOYEE	FAMILY WORKERS	TEMP. EMPLOYMENT	PART-TIME EMPLOYMENT	INVOLUNTARY PART-TIME	AV.USUAL WEEK HRS	AV.USUAL WEEK HRS SELF-EMP	AV.USUAL WEEK HRS EMPL.	REGION
(% all in Emp.)	(% all in Emp.)	(% Employee)	(% all in Emp.)	(% Part-time)	(Hours)	(Hours)	(Hours)	
82.7	2.5	10.3	19.8 ⁽¹⁾	20.3	37.2	53.9	35.1	BELGIQUE-BELGIE
83.3	1.3	10.9	15.8 ⁽¹⁾	31.3	37.5	46.2	36.3	Bruxelles-CapBrusselsHf.gewest
84.8	1.7	8.4	20.7 ⁽¹⁾	9.4	37.3	55.4	35.2	Antwerpen
83.4	2.1	13.2	24.5 ⁽¹⁾	22.3	36.0	53.1	34.0	Limburg (B)
80.2	2.5	10.0	19.0 ⁽¹⁾	16.0	38.8	58.2	35.6	Oost-Vlaanderen
86.7	2.2	7.4	17.8 ⁽¹⁾	11.8	38.0	54.2	36.5	Vlaams Brabant
79.3	4.7	10.5	20.4 ⁽¹⁾	18.3	37.4	56.4	34.4	West-Vlaanderen
79.5	(3.0)	11.9	21.5 ⁽¹⁾	(19.1)	36.8	49.7	35.1	Brabant Wallon
83.7	2.3	11.5	18.3 ⁽¹⁾	30.6	36.0	54.5	34.2	Hainaut
81.6	2.2	12.8	20.3 ⁽¹⁾	27.0	36.4	50.1	34.4	Liège
82.1	(3.2)	8.3	24.7 ⁽¹⁾	32.8	35.5	55.3	33.8	Luxemburg (B)
82.8	(2.7)	10.5	20.6 ⁽¹⁾	35.1	35.9	53.0	34.3	Namur
90.7	1.0	10.2	20.8	15.3	35.8	48.1	34.7	DANMARK
89.2	0.8	13.1	19.0	13.0	37.2	50.1	35.8	DEUTSCHLAND
89.7	1.1	11.6	20.8	6.5	36.4	49.5	35.2	Stuttgart
89.4	.	12.7	21.3	7.7	36.5	49.7	35.1	Karlsruhe
87.7	1.4	10.6	21.0	5.2	36.9	50.6	35.2	Freiburg
88.2	1.1	11.8	21.5	7.9	36.8	52.2	35.1	Tübingen
84.6	1.5	10.2	20.4	5.6	37.5	48.6	35.7	Oberbayern
85.5	2.9	10.7	20.1	.	37.4	53.7	35.2	Niederbayern
86.0	3.2	11.1	20.0	.	37.5	53.9	35.5	Oberplatz
90.1	.	10.7	19.9	11.6	37.1	51.0	35.8	Oberfranken
86.1	2.4	10.8	20.1	7.9	37.5	51.6	35.7	Mittelfranken
88.9	.	10.2	20.4	6.7	36.7	52.0	35.0	Unterfranken
87.9	1.8	10.3	20.3	.	37.0	52.7	35.1	Schwaben
86.8	.	14.5	21.4	22.6	36.9	46.9	35.5	Berlin-West, Stadt
90.6	.	18.2	14.5	27.7	38.4	48.2	37.4	Berlin-Ost, Stadt
91.2	.	18.9	11.0	52.0	38.8	48.8	37.9	Brandenburg
90.2	.	12.9	21.9	.	35.8	44.6	35.0	Bremen
87.5	.	13.0	21.9	14.2	36.4	47.2	35.0	Hamburg
88.1	0.6	10.5	20.4	8.1	37.3	49.2	35.9	Darmstadt
87.5	.	12.1	23.2	.	36.6	49.5	35.0	Gießen
89.6	1.5	12.8	22.3	10.3	36.5	53.6	34.9	Kassel
93.2	.	23.5	10.5	59.4	39.4	52.7	38.4	Mecklenburg-Vorpommern
91.7	.	14.3	20.4	9.9	36.0	52.6	34.7	Braunschweig
90.0	.	11.2	20.2	12.0	36.8	49.9	35.5	Hannover
88.8	1.1	10.6	21.8	8.6	36.9	48.4	35.6	Lüneburg
87.8	1.4	11.4	20.3	6.1	36.7	49.6	35.2	Weser-Ems
89.1	0.5	10.8	19.0	8.2	37.1	50.3	35.6	Düsseldorf
89.7	0.4	12.2	20.1	8.0	36.8	49.7	35.4	Köln
91.0	.	12.7	20.9	7.3	36.2	50.9	34.9	Münster
91.0	.	12.5	19.9	8.4	36.3	49.0	35.1	Detmold
91.3	.	11.8	19.7	8.9	36.4	51.5	35.0	Arnsberg
89.9	1.3	10.1	19.9	10.2	36.9	51.6	35.6	Koblenz
89.4	.	13.1	20.6	.	37.4	55.0	35.6	Trier
88.4	0.9	11.1	20.9	10.8	36.7	49.7	35.2	Rheinessen-Pfalz
90.0	.	12.9	20.4	.	36.4	47.6	35.3	Saarland
90.5	.	19.5	12.7	51.3	38.7	49.6	37.6	Sachsen
92.1	.	19.3	10.9	49.5	39.2	49.8	38.4	Dessau
93.6	.	17.7	11.1	49.0	38.9	48.7	38.3	Halle
92.2	.	18.4	9.7	48.2	39.5	50.6	38.6	Magdeburg
88.5	0.7	12.9	22.5	9.8	36.8	50.7	35.1	Schleswig-Holstein
92.2	.	18.6	11.2	47.8	39.3	51.8	38.3	Thüringen
56.6	10.9	13.0	6.0	44.8	43.1	48.7	39.9	ELLADA ⁽²⁾
43.6	20.5	22.4	6.0	52.4	44.2	50.0	39.6	Anatoliki Makedonia, Thraki
52.7	11.8	12.6	5.7	45.3	43.2	49.0	39.6	Kentriki Makedonia
48.7	12.1	24.1	5.2	(54.5)	43.5	47.8	39.8	Dytiki Makedonia
44.8	17.2	20.7	6.7	44.5	45.1	51.5	39.8	Thessalia
49.2	9.6	16.1	4.8	.	44.9	50.5	40.1	Ipeiros
41.8	16.0	18.3	10.8	(31.4)	42.7	44.4	41.9	Ionia Nisia
41.7	19.8	14.8	8.2	60.1	42.6	47.1	39.2	Dytiki Ellada
44.7	13.8	12.3	7.0	45.1	44.1	47.5	41.0	Stereia Ellada

⁽¹⁾ Only Employees.

⁽²⁾ 1998.

Table 52

Main characteristics of employment by region, for the population aged 15 to 64 years

REGION	EMPLOY- MENT AGE 15-64 (Rate)	EMPLOY- MENT AGE 15-24 (Rate)	EMPLOY- MENT AGE 25-49 (Rate)	EMPLOY- MENT AGE 50-64 (Rate)	EMPLOY- MENT NATI. (Rate)	EMPLOY- MENT EU-NATI. (Rate)	EMPLOY- MENT NON-EU - NON-NATI. (Rate)	SELF- EMPLOY- MENT (% all in Emp.)
Peloponnisos	61.1	32.6	73.7	55.8	61.0	.	(67.4)	44.3
Attiki	54.0	26.5	72.3	38.5	53.4	(47.9)	67.0	22.9
Voreio Aigaio	51.5	28.6	62.4	46.8	51.4	.	.	38.3
Notio Aigaio	57.9	41.5	69.6	48.5	58.1	.	.	35.0
Kriti	64.2	34.5	78.2	61.7	63.8	.	79.2	38.8
ESPAÑA	52.3	29.2	67.1	43.1	52.2	51.2	64.2	19.3
Galicja	52.4	23.6	67.4	48.1	52.3	(65.8)	.	26.9
Principado de Asturias	45.0	18.0	60.9	37.4	45.1	.	.	23.0
Cantabria	47.9	23.0	63.2	40.4	47.9	.	.	20.4
Pais Vasco	54.2	25.1	72.0	41.8	54.3	.	.	20.1
Comunidad Foral de Navarra	58.6	32.4	74.1	50.0	58.6	.	.	22.7
La Rioja	56.7	28.8	73.0	47.2	56.8	.	.	28.6
Aragón	57.1	35.7	71.5	45.7	57.2	.	.	20.8
Comunidad de Madrid	54.7	29.0	71.4	46.6	54.4	58.9	73.3	10.3
Castilla y León	51.7	21.7	67.5	45.8	51.7	.	.	27.3
Castilla-la Mancha	52.1	34.1	64.4	43.1	52.0	.	60.3	25.9
Extremadura	45.7	26.0	58.1	37.7	45.7	.	.	24.1
Cataluna	60.0	39.5	74.7	47.5	59.9	74.6	65.1	18.6
Comunidad Valenciana	54.6	34.7	68.6	42.9	54.7	43.3	62.4	18.8
Islas Baleares	62.1	36.6	76.9	48.6	62.3	(51.6)	(68.2)	19.2
Andalucia	42.9	24.1	56.5	33.7	42.9	39.0	52.7	18.8
Región de Murcia	51.8	32.2	65.1	42.3	51.4	.	80.9	18.1
Ceuta e Melilla	43.8	20.8	57.6	39.4	44.8	.	.	15.7
Canarias	52.1	29.1	66.2	41.9	52.1	50.0	59.0	15.6
FRANCE	60.4	26.5	77.8	47.0	61.3	64.1	40.4	10.6
Île de France	64.6	26.1	80.0	55.6	66.3	70.9	46.9	7.8
Champagne-Ardenne	58.0	24.3	76.4	45.7	58.6	62.1	(33.6)	11.5
Picardie	58.8	26.7	75.7	45.4	59.9	70.3	31.3	8.7
Haute-Normandie	60.0	25.2	76.5	47.5	60.8	67.0	(27.1)	6.9
Centre	63.8	32.9	81.4	45.9	64.6	68.4	37.7	10.3
Basse-Normandie	61.3	28.0	80.5	48.5	61.4	.	.	14.7
Bourgogne	62.5	28.7	79.6	49.5	63.2	55.8	(31.2)	11.2
Nord - Pas-de-Calais	50.8	18.5	68.7	39.7	51.5	57.5	25.8	7.3
Lorraine	58.5	26.6	77.1	42.1	58.9	66.0	39.4	8.7
Alsace	65.6	39.2	82.7	45.1	66.8	64.2	45.0	7.3
Franche-Comté	62.4	30.7	80.6	46.5	63.6	(58.9)	43.5	10.4
Pays de la Loire	62.0	31.2	80.1	41.1	62.3	(69.8)	32.4	11.1
Bretagne	61.7	22.4	82.8	44.4	61.9	(58.4)	(36.4)	13.7
Poitou-Charentes	62.6	27.9	82.2	44.2	62.9	.	.	13.2
Aquitaine	60.0	25.0	78.4	46.1	60.4	54.3	40.2	14.8
Midi-Pyrénées	60.9	25.6	79.4	47.8	61.8	48.1	32.8	14.9
Limousin	60.7	24.9	81.4	45.6	61.2	.	.	16.8
Rhône-Alpes	62.5	29.1	79.6	51.4	63.7	59.0	41.7	11.1
Auvergne	59.0	23.9	79.4	43.2	59.5	(48.3)	(43.3)	14.8
Languedoc-Roussillon	52.2	23.9	68.2	41.3	53.9	48.8	23.8	14.9
Provence-Alpes-Côte d'Azur	55.1	26.9	70.3	42.1	56.3	57.0	35.5	11.9
Corse	42.8	(18.1)	57.5	29.5	47.6	.	(22.2)	14.8
Guadeloupe	-	-	-	-	-	-	-	-
Martinique	-	-	-	-	-	-	-	-
Guyane	-	-	-	-	-	-	-	-
Réunion	-	-	-	-	-	-	-	-
IRELAND	62.5	46.5	75.1	51.3	62.6	63.6	44.8	17.8
Border, Midlands and Western	59.4	41.8	72.7	51.1	59.6	53.6	.	23.1
Southern and Eastern	63.6	48.2	75.9	51.4	63.7	66.9	44.0	16.1
ITALIA	52.5	25.5	68.6	37.9	52.4	65.0	67.0	24.4
Piemonte	58.7	35.1	78.3	35.1	58.7	.	60.0	24.0
Valle d'Aosta	62.4	(40.5)	81.3	35.6	62.4	.	.	28.2
Liguria	55.2	29.8	72.9	36.5	55.0	.	85.9	25.3
Lombardia	60.5	39.6	79.4	34.9	60.3	70.0	67.3	23.0
Trentino - Alto Adige	63.2	43.7	79.5	39.9	63.1	.	.	22.3
Veneto	60.2	42.4	77.6	35.0	60.1	.	71.9	24.5

(a) 1998.

Table 52

Main characteristics of employment by region, for the population aged 15 to 64 years

EMPLOYEE (% all in Emp.)	FAMILY WORKERS (% all in Emp.)	TEMP. EMPLOY- MENT (% Employee)	PART-TIME EMPLOY- MENT (% all in Emp.)	INVOLUN- TARY PART-TIME (% Part-time)	AV.USUAL WEEK HRS (Hours)	AV.USUAL WEEK HRS SELF-EMP (Hours)	AV.USUAL WEEK HRS EMPL. (Hours)	REGION
35.2	20.5	12.6	10.9	29.8	43.7	46.9	40.1	Peloponnisos
73.2	3.9	8.9	4.3	53.9	42.0	49.1	39.6	Attiki
51.8	9.9	17.8	(6.6)	.	44.7	48.1	42.1	Voreio Aigaio
55.8	9.2	22.5	(3.4)	.	46.7	51.0	43.5	Notio Aigaio
44.9	16.3	23.7	8.8	25.6	43.3	46.7	41.3	Kriti
78.3	2.4	32.7	8.3	25.1	40.2	46.5	38.7	ESPAÑA
67.5	5.6	32.8	6.5	11.3	41.7	47.1	39.1	Galicia
74.1	2.9	27.4	5.0	(30.9)	43.9	57.0	39.3	Principado de Asturias
75.6	4.0	28.0	4.7	.	41.4	49.5	39.2	Cantabria
79.0	0.9	32.9	10.6	32.1	38.8	44.9	37.3	Pais Vasco
75.9	(1.4)	24.7	8.1	(17.6)	40.0	46.4	38.2	Comunidad Foral de Navarra
70.5	.	27.1	(5.2)	.	40.5	45.7	38.3	La Rioja
76.7	2.4	26.4	8.2	18.2	40.6	48.7	38.5	Aragón
88.4	1.3	19.5	4.9	28.7	39.8	45.4	39.1	Comunidad de Madrid
69.5	3.2	28.8	9.4	22.3	40.5	48.0	37.7	Castilla y León
69.9	4.2	38.4	8.9	22.9	40.7	46.2	38.8	Castilla-la Mancha
72.8	3.1	37.4	8.1	(13.6)	40.5	46.3	38.6	Extremadura
79.6	1.9	29.0	9.4	19.3	39.5	45.1	38.3	Cataluna
79.7	1.6	38.9	11.1	32.2	40.0	45.4	38.8	Comunidad Valenciana
79.7	(1.1)	28.2	5.5	(26.3)	39.7	42.8	38.9	Islas Baleares
77.9	3.2	46.6	8.9	33.0	40.4	47.1	38.9	Andalucia
79.0	2.9	42.1	7.5	30.2	39.7	45.3	38.7	Región de Murcia
83.9	.	34.4	(9.2)	.	38.8	43.7	37.9	Ceuta e Melilla
82.7	1.7	38.6	9.6	16.7	39.9	45.4	39.1	Canarias
87.8	1.5	14.0	17.2	27.5	37.7	52.4	36.6	FRANCE
91.8	0.4	11.1	13.1	26.5	38.6	51.0	37.9	Île de France
86.2	2.3	14.3	17.3	24.4	37.2	50.5	36.2	Champagne-Ardenne
90.0	(1.2)	15.0	16.0	38.3	36.9	53.5	36.1	Picardie
92.1	(1.0)	14.1	16.9	33.3	37.2	53.0	36.4	Haute-Normandie
88.1	1.6	13.7	15.5	28.9	37.2	48.2	36.4	Centre
81.2	4.1	14.1	18.0	29.5	38.4	54.7	36.1	Basse-Normandie
87.0	1.8	13.0	15.4	28.7	38.0	54.8	36.6	Bourgogne
91.6	1.1	16.7	18.6	30.7	36.0	54.2	35.1	Nord - Pas-de-Calais
90.0	1.3	14.6	18.4	28.3	37.6	53.6	36.5	Lorraine
91.8	(0.8)	14.1	15.9	17.3	37.6	52.7	36.8	Alsace
88.0	(1.6)	15.3	18.0	22.5	37.4	54.1	36.1	Franche-Comté
87.0	2.0	16.5	19.6	29.3	37.8	55.7	36.3	Pays de la Loire
83.6	2.7	15.2	19.6	21.0	38.7	54.5	36.8	Bretagne
83.8	3.0	14.8	19.2	30.3	38.2	52.2	36.5	Poitou-Charentes
83.3	2.0	14.9	18.1	29.6	37.9	52.2	36.2	Aquitaine
83.0	2.2	13.3	20.5	25.8	37.2	50.9	35.7	Midi-Pyrénées
79.9	(3.2)	13.7	16.7	31.7	38.3	55.3	36.1	Limousin
87.4	1.5	14.1	19.8	20.2	37.1	51.5	36.1	Rhône-Alpes
81.7	3.5	15.1	19.0	30.9	37.9	57.7	35.6	Auvergne
82.9	2.2	17.0	22.3	32.8	36.2	49.3	34.8	Languedoc-Roussillon
87.0	1.1	15.3	17.7	33.2	37.3	49.9	36.3	Provence-Alpes-Côte d'Azur
84.6	.	(11.2)	15.7	(49.0)	43.2	(57.8)	41.3	Corse
-	-	-	-	-	-	-	-	Guadeloupe
-	-	-	-	-	-	-	-	Martinique
-	-	-	-	-	-	-	-	Guyane
-	-	-	-	-	-	-	-	Réunion
80.9	1.2	7.7 ⁽³⁾	16.7	12.7	38.1	51.6	36.2	IRELAND
75.4	1.4	7.6 ⁽³⁾	15.8	17.1	38.8	52.5	36.3	Border, Midlands and Western
82.7	1.2	7.7 ⁽³⁾	17.1	11.4	37.9	51.2	36.1	Southern and Eastern
71.7	3.9	9.8	7.9	36.4	39.2	44.6	37.2	ITALIA
72.3	3.7	7.1	7.3	35.1	39.4	44.1	37.7	Piemonte
68.8	.	(10.2)	(9.1)	.	39.3	45.5	36.5	Valle d'Aosta
71.3	3.4	6.5	8.6	31.9	38.9	44.0	37.0	Liguria
74.0	3.0	6.3	8.5	23.9	39.3	44.2	37.7	Lombardia
71.8	5.9	31.8	10.6	(9.5)	39.4	45.8	37.3	Trentino - Alto Adige
71.4	4.1	7.8	8.4	20.5	39.6	45.4	37.6	Veneto

(3) 1998.

Table 52

Main characteristics of employment by region, for the population aged 15 to 64 years

REGION	EMPLOY- MENT AGE 15-64 (Rate)	EMPLOY- MENT AGE 15-24 (Rate)	EMPLOY- MENT AGE 25-49 (Rate)	EMPLOY- MENT AGE 50-64 (Rate)	EMPLOYM. NATI. (Rate)	EMPLOYM. EU-NATI. (Rate)	EMPLOYM. NON-EU - NON-NATI. (Rate)	SELF- EMPLOY- MENT (% all in Emp.)
Friuli - Venezia Giulia	58.6	36.4	78.1	34.5	58.6	.	63.9	22.8
Emilia-Romagna	64.2	40.2	83.5	40.0	64.1	.	62.9	27.5
Toscana	57.4	33.4	74.8	38.3	57.4	56.9	59.7	27.9
Umbria	57.2	28.8	76.5	37.6	57.3	.	.	27.5
Marche	59.9	32.5	79.2	39.3	59.7	.	78.1	27.7
Lazio	51.1	15.5	66.3	43.0	51.0	.	74.2	22.6
Abruzzo	51.6	19.8	66.6	43.0	51.6	.	.	24.4
Molise	49.1	(16.9)	63.0	43.7	49.1	.	.	32.2
Campania	40.2	12.3	51.9	40.1	40.2	.	.	23.1
Puglia	42.4	17.8	53.7	40.0	42.3	.	(56.3)	24.9
Basilicata	43.8	12.9	57.4	39.8	43.8	.	.	26.2
Calabria	38.4	10.2	49.1	40.5	38.4	.	.	23.9
Sicilia	39.2	13.3	51.2	35.7	39.2	.	70.3	23.0
Sardegna	44.2	14.5	58.4	37.0	44.1	.	.	25.3
LUXEMBOURG (Grand-Duché)	61.6	31.7	78.4	40.0	59.5	66.5	52.1	8.4
NEDERLAND	70.9	62.7	82.5	50.0	72.1	70.9	33.7	10.7
Groningen	66.4	56.1	79.0	44.5	66.8	.	.	10.9
Friesland	70.1	66.9	81.9	48.4	70.7	.	.	13.4
Drenthe	66.1	56.3	77.7	48.5	67.0	.	.	9.6
Overijssel	70.5	61.8	82.0	50.6	71.5	.	(33.4)	11.3
Gelderland	71.2	61.6	83.1	51.1	72.1	69.1	(30.9)	12.2
Flevoland	72.6	60.8	82.4	51.0	73.6	.	.	7.9
Utrecht	73.9	66.5	83.3	55.2	75.2	82.2	(35.2)	9.7
Noord-Holland	71.5	62.7	82.8	50.5	73.2	77.2	29.1	10.8
Zuid-Holland	70.9	60.8	81.9	52.1	72.6	65.4	36.1	10.1
Zeeland	68.7	62.8	81.3	46.3	69.7	.	.	10.3
Noord-Brabant	72.0	67.7	84.0	48.5	72.8	69.1	39.8	10.1
Limburg (NL)	69.6	61.4	83.4	45.3	70.1	77.3	(37.7)	11.0
ÖSTERREICH	68.2	54.9	82.6	44.5	68.2	75.9	66.6	10.9
Burgenland	67.4	56.9	82.5	40.8	67.7	.	61.4	9.2
Niederösterreich	68.4	56.3	84.1	43.6	68.4	86.6	66.0	13.7
Wien	69.3	51.6	82.8	49.4	69.6	82.1	66.3	8.3
Kärnten	64.8	49.3	79.9	41.1	64.5	.	74.8	11.1
Steiermark	66.7	54.1	81.9	40.8	66.4	86.4	69.2	11.5
Oberösterreich	68.6	57.9	82.4	43.3	69.2	76.2	55.9	10.7
Salzburg	70.7	55.8	85.2	46.8	70.0	77.2	75.4	11.0
Tirol	68.2	55.1	81.2	46.4	68.5	59.0	67.4	11.9
Vorarlberg	68.1	58.7	81.4	44.0	67.6	76.3	70.5	8.0
PORTUGAL	67.4	43.3	82.3	58.4	67.5	58.3	63.8	24.9
Norte	67.8	49.9	80.7	55.6	67.9	(50.5)	61.0	24.1
Centro (P)	72.4	40.1	87.7	71.1	72.5	58.1	69.5	38.0
Lisboa e Vale do Tejo	66.0	39.8	82.2	56.0	66.0	66.9	63.4	18.8
Alentejo	63.4	35.5	81.6	53.5	63.5	.	.	19.6
Algarve	67.5	33.5	85.9	59.7	67.4	.	.	27.9
Açores	59.1	40.3	73.7	46.7	59.0	.	.	25.9
Madeira	64.0	36.8	79.2	60.6	64.3	.	.	20.0
SUOMI/FINLAND	67.4	45.0	80.9	56.3	67.7	62.3	46.7	13.0
Uusimaa	59.3	32.3	75.2	47.1	59.5	.	.	16.6
Etelä-Suomi	64.3	40.5	79.2	53.7	64.5	.	.	17.0
Itä-Suomi	62.5	40.1	76.1	52.5	62.5	.	.	14.1
Väli-Suomi	74.4	53.8	85.2	64.9	74.8	.	52.5	8.5
Pohjois-Suomi	67.5	47.1	81.3	55.1	67.8	.	40.8	13.8
Ahvenanmaa/Åland	72.7	.	86.3	(79.5)	73.3	.	.	(21.1)
SVERIGE	70.6	35.4	81.4	72.6	71.7	71.6	38.4	10.9
Stockholm	77.6	43.6	85.9	78.7	78.9	72.9	53.8	10.5
Östra Mellansverige	71.5	38.0	81.9	72.5	72.6	76.0	33.5	10.0
Småland med Öarna	69.5	34.7	79.5	72.4	70.7	.	36.5	12.8
Sydsverige	68.4	34.8	77.6	70.4	69.2	.	.	10.1
Västsverige	69.3	33.4	79.9	69.7	69.3	.	.	12.7

Table 52

Main characteristics of employment by region, for the population aged 15 to 64 years

EMPLOYEE (% all in Emp.)	FAMILY WORKERS (% all in Emp.)	TEMP. EMPLOY- MENT (% Employee)	PART-TIME EMPLOY- MENT (% all in Emp.)	INVOLUN- TARY PART-TIME (% Part-time)	AV.USUAL WEEK HRS (Hours)	AV.USUAL WEEK HRS SELF-EMP (Hours)	AV.USUAL WEEK HRS EMPL. (Hours)	REGION
72.5	4.7	8.0	10.9	23.5	37.7	42.6	36.3	Friuli - Venezia Giulia
67.8	4.6	7.9	8.4	26.8	39.5	44.2	37.5	Emilia-Romagna
68.8	3.3	8.0	9.6	34.1	38.5	42.8	36.8	Toscana
69.7	2.8	8.7	6.8	(33.4)	39.5	45.6	36.9	Umbria
67.7	4.7	7.1	8.3	31.6	39.6	45.8	36.8	Marche
74.0	3.4	8.5	6.6	49.0	39.2	45.2	37.2	Lazio
70.3	5.3	7.8	6.0	49.1	39.7	46.0	37.5	Abruzzo
62.5	(5.3)	11.6	(6.9)	52.7	39.5	45.0	36.6	Molise
72.5	4.4	12.8	5.7	55.5	39.5	45.8	37.2	Campania
70.6	4.5	14.0	6.0	60.9	39.6	45.1	37.6	Puglia
69.1	4.7	11.4	5.4	(45.4)	40.2	47.3	37.5	Basilicata
72.5	3.6	18.2	8.9	74.3	38.1	44.5	35.8	Calabria
73.1	3.9	16.2	8.3	63.7	38.3	44.2	36.4	Sicilia
70.7	4.0	16.2	8.8	47.8	38.4	44.1	36.1	Sardegna
90.9	(0.7)	3.4	10.7	9.8	38.5	50.4	37.7	LUXEMBOURG (Grand-Duché)
88.5	0.8	12.0	39.4	4.3	32.2	42.8	31.0	NEDERLAND
88.3	.	17.7	43.7	(6.6)	31.1	38.3	30.1	Groningen
85.8	.	15.9	41.4	.	32.2	43.4	30.6	Friesland
89.7	.	13.3	41.1	(5.6)	31.6	40.8	30.6	Drenthe
87.2	(1.5)	12.9	38.9	(3.8)	32.2	46.9	30.4	Overijssel
87.0	(0.7)	12.4	40.7	3.4	32.0	43.4	30.5	Gelderland
91.2	.	12.1	36.4	.	33.0	38.5	32.5	Flevoland
89.6	.	11.9	40.2	(3.0)	31.7	38.5	31.0	Utrecht
88.7	(0.4)	11.5	41.3	5.3	32.2	41.1	31.1	Noord-Holland
89.3	0.6	10.2	37.6	4.5	32.8	43.7	31.6	Zuid-Holland
89.0	.	11.1	39.6	.	32.4	47.2	30.6	Zeeland
88.8	1.2	11.5	38.1	3.7	32.1	43.8	30.8	Noord-Brabant
87.8	(1.2)	12.6	37.7	(4.4)	32.3	43.4	30.9	Limburg (NL)
86.3	2.8	7.5	16.8	11.3	38.5	48.8	37.2	ÖSTERREICH
89.0	1.8	6.9	14.9	.	38.0	46.8	37.1	Burgenland
84.0	2.3	6.9	16.0	17.5	38.9	50.5	37.0	Niederösterreich
90.8	0.9	6.1	15.7	12.7	38.3	41.9	37.9	Wien
86.0	3.0	7.9	14.3	13.0	39.0	48.0	37.8	Kärnten
83.6	4.8	7.1	16.0	11.2	38.8	49.8	37.0	Steiermark
85.5	3.8	8.6	19.7	8.7	38.4	52.6	36.5	Oberösterreich
86.0	3.0	8.1	19.1	7.2	38.2	48.0	36.8	Salzburg
84.7	3.4	10.2	17.2	7.7	38.8	49.5	37.3	Tirol
89.6	2.4	8.6	17.0	.	38.0	49.6	37.0	Vorarlberg
73.1	2.0	18.6	11.0	23.7	40.0	42.0	39.5	PORTUGAL
73.3	2.7	14.7	9.2	25.5	41.0	44.4	39.9	Norte
59.5	2.4	18.4	19.9	12.8	38.3	37.1	39.4	Centro (P)
80.2	1.0	20.5	8.6	33.0	40.0	43.3	39.3	Lisboa e Vale do Tejo
77.8	2.5	33.6	6.2	47.1	40.2	46.5	38.6	Alentejo
70.9	.	25.0	7.4	(32.5)	41.1	43.6	40.2	Algarve
70.6	(3.5)	22.8	10.9	.	39.9	44.2	38.4	Açores
79.5	.	12.1	12.6	(29.9)	38.8	40.7	38.4	Madeira
86.2	0.8	18.2	12.2	37.9	38.6	49.1	37.2	SUOMI/FINLAND
81.7	(1.6)	21.9	12.9	52.2	39.3	51.9	36.9	Uusimaa
81.8	(1.2)	19.4	13.6	45.3	39.2	50.6	36.9	Etelä-Suomi
85.1	.	23.7	12.9	49.2	39.0	51.7	37.0	Itä-Suomi
91.3	.	16.1	11.3	23.3	37.9	45.6	37.2	Väli-Suomi
85.4	0.9	17.1	12.2	38.6	38.7	48.4	37.3	Pohjois-Suomi
78.9	44.7	(54.7)	42.0	Ahvenanmaa/Åland
88.5	0.5	13.9	23.8	29.6	36.6	44.4	35.8	SVERIGE
89.4	.	10.8	18.6	27.6	36.7	39.8	36.4	Stockholm
89.6	.	14.7	24.8	28.8	36.6	46.0	35.7	Östra Mellansverige
86.6	.	15.2	24.8	23.9	37.0	46.4	35.8	Småland med Öarna
89.3	.	15.6	28.1	33.7	35.9	43.0	35.2	Sydsverige
86.6	.	18.6	25.7	46.1	36.6	46.9	35.3	Västsverige

Table 52

Main characteristics of employment by region, for the population aged 15 to 64 years

REGION	EMPLOY- MENT AGE 15-64 (Rate)	EMPLOY- MENT AGE 15-24 (Rate)	EMPLOY- MENT AGE 25-49 (Rate)	EMPLOY- MENT AGE 50-64 (Rate)	EMPLOYM. NATI. (Rate)	EMPLOYM. EU-NATI. (Rate)	EMPLOYM. NON-EU - NON-NATI. (Rate)	SELF- EMPLOY- MENT (% all in Emp.)
Norra Mellansverige	64.7	35.6	73.3	65.6	64.8	.	.	8.1
Mellersta Norrland	73.0	44.4	83.9	69.9	73.9	.	.	9.9
Övre Norrland	71.9	41.9	80.9	72.5	73.9	65.2	26.3	12.2
UNITED KINGDOM	70.4	55.0	80.3	60.0	71.0	64.8	52.7	11.7
Tees Valley & Durham	61.7	44.2	74.3	48.3	61.8	.	.	8.5
Northumbria, Tyne and Wear	61.3	44.3	73.8	47.2	61.7	.	.	9.1
Cumbria	68.5	58.5	79.0	57.8	68.7	.	.	15.2
Cheshire	71.2	59.3	83.2	55.0	71.2	.	.	10.5
Greater Manchester	68.0	50.7	78.9	56.5	68.6	53.3	51.1	9.7
Lancashire	71.0	55.8	81.7	60.4	71.3	.	.	11.5
Merseyside	59.0	42.1	71.2	46.6	59.2	.	.	9.8
East Riding & North Lincolnshire	66.3	50.1	78.5	53.5	66.5	.	.	9.4
North Yorkshire	74.7	68.7	83.9	62.0	74.5	.	.	13.7
South Yorkshire	65.9	51.4	76.8	52.1	66.2	.	.	7.9
West Yorkshire	69.5	55.7	80.9	54.5	70.5	.	44.6	9.9
Derbyshire, Nottinghamshire	70.7	56.7	82.0	56.6	70.9	.	.	11.5
Leicestershire, Northamptonshire	75.6	56.3	85.2	66.7	75.7	.	65.0	10.8
Lincolnshire	71.4	54.1	82.4	62.5	71.5	.	.	12.6
Herefordsh, Worcestersh&Warks	75.7	59.5	84.2	69.1	75.8	.	.	12.3
Shropshire, Staffordshire	73.2	58.9	82.3	64.1	73.5	.	.	12.5
West Midlands	66.3	49.7	76.0	57.6	67.3	62.7	44.1	8.1
East Anglia	74.6	62.3	82.9	65.6	74.8	.	64.7	12.6
Bedfordshire, Hertfordshire	75.6	58.4	85.0	65.7	76.4	69.8	54.9	12.8
Essex	74.3	62.8	82.9	64.4	74.6	.	.	14.5
Inner London	64.5	45.8	72.3	54.6	67.5	65.7	48.8	15.4
Outer London	72.1	57.1	80.1	64.2	73.7	73.9	54.5	12.8
Berkshire, Bucks, Oxfordshire	79.0	66.4	86.6	71.2	79.8	76.0	60.0	11.4
Surrey, East-West Sussex	77.1	62.6	85.0	70.4	77.7	69.8	61.5	15.3
Hampshire, Isle of Wight	75.8	58.6	85.1	67.7	76.3	70.5	.	10.7
Kent	73.9	59.1	82.1	67.4	74.0	.	.	12.1
Avon, Gloucestersh., Wiltsh.&NS	77.7	64.2	85.8	69.4	77.8	74.5	75.4	12.4
Dorset, Somerset	74.9	60.0	85.0	64.0	75.6	.	.	14.8
Cornwall & Isles of Scilly	67.2	59.0	78.8	54.5	67.1	.	.	18.1
Devon	72.7	57.0	81.3	65.9	72.7	.	.	15.3
West Wales & the Valleys	62.6	50.4	75.4	47.3	62.8	.	.	10.9
East Wales	69.0	49.2	81.3	57.4	69.4	.	.	12.5
North Eastern Scotland	77.9	66.3	84.6	70.5	77.9	.	.	10.6
Eastern Scotland	70.6	51.7	82.4	58.5	70.7	.	.	8.3
South Western Scotland	62.0	46.4	73.7	47.7	63.4	.	29.8	9.2
Highlands, Islands	72.8	61.2	82.8	61.7	72.7	.	.	12.9
Northern Ireland	62.7	47.0	74.1	51.8	63.0	55.7	.	11.9

Table 52

Main characteristics of employment by region, for the population aged 15 to 64 years

EMPLOYEE (% all in Emp.)	FAMILY WORKERS (% all in Emp.)	TEMP. EMPLOY- MENT (% Employee)	PART-TIME EMPLOY- MENT (% all in Emp.)	INVOLUN- TARY PART-TIME (% Part-time)	AV.USUAL WEEK HRS (Hours)	AV.USUAL WEEK HRS SELF-EMP (Hours)	AV.USUAL WEEK HRS EMPL. (Hours)	REGION
91.2	.	20.5	25.0	36.9	36.5	42.2	35.8	Norra Mellansverige
89.3	.	11.6	26.3	30.4	36.5	46.6	35.4	Mellersta Norrland
87.1	.	13.2	23.6	27.5	36.8	45.5	35.7	Övre Norrland
87.9	0.4	6.8	24.8	10.3	37.8	42.5	37.3	UNITED KINGDOM
91.2	.	7.8	26.2	15.9	36.8	45.5	36.1	Tees Valley & Durham
90.9	.	8.2	27.4	13.8	36.4	40.5	36.0	Northumbria, Tyne and Wear
83.7	.	9.8	28.6	.	37.3	44.7	36.2	Cumbria
88.8	.	6.5	25.6	9.1	37.6	40.0	37.4	Cheshire
90.1	.	5.0	20.6	10.7	38.2	44.2	37.7	Greater Manchester
88.2	.	6.8	25.8	8.3	37.3	42.2	36.8	Lancashire
90.0	.	5.7	26.6	13.6	36.7	45.0	35.8	Merseyside
90.0	.	7.6	28.2	12.9	37.0	40.5	36.8	East Riding & North Lincolnshire
86.0	.	6.2	25.8	.	37.8	45.0	36.6	North Yorkshire
91.7	.	7.8	27.4	12.5	36.8	40.1	36.6	South Yorkshire
89.8	.	7.5	26.3	11.5	37.4	44.1	36.7	West Yorkshire
88.3	.	5.0	25.6	11.0	37.9	41.7	37.5	Derbyshire, Nottinghamshire
89.0	.	6.5	25.4	8.3	37.9	42.7	37.4	Leicestershire, Northamptonshire
87.1	.	5.6	27.7	.	38.3	42.9	37.8	Lincolnshire
87.1	.	5.7	27.1	9.3	37.6	41.4	37.3	Herefordsh.,Worcestersh.&Warks
87.2	.	5.6	25.0	9.8	37.7	41.9	37.1	Shropshire, Staffordshire
91.5	.	6.3	24.1	8.6	37.1	42.6	36.7	West Midlands
87.1	.	6.7	25.2	8.6	38.0	42.5	37.4	East Anglia
86.9	.	6.1	23.5	5.5	38.3	41.7	37.9	Bedfordshire, Hertfordshire
85.2	.	4.6	24.2	7.2	38.0	41.1	37.5	Essex
84.3	.	9.7	17.8	18.5	40.2	43.0	39.7	Inner London
86.9	.	7.0	22.8	10.3	38.2	41.2	37.9	Outer London
88.4	.	8.1	22.6	5.9	38.7	38.9	38.8	Berkshire,Bucks,Oxfordshire
84.1	.	7.3	27.4	5.6	37.7	39.6	37.5	Surrey, East-West Sussex
88.8	.	6.3	26.3	8.0	37.6	42.1	37.1	Hampshire, Isle of Wight
87.5	.	5.4	26.2	8.2	37.9	42.3	37.4	Kent
87.1	.	6.0	26.7	8.3	37.4	42.0	36.9	Avon,Gloucestersh.,Wiltsh.&NS
84.8	.	6.8	29.9	7.3	36.8	41.8	35.9	Dorset, Somerset
81.1	.	8.1	24.7	.	39.5	49.8	37.4	Cornwall & Isles of Scilly
84.3	.	7.8	30.3	11.6	36.2	40.5	35.5	Devon
88.6	.	6.8	23.6	14.8	37.5	43.3	36.9	West Wales & the Valleys
87.1	.	8.4	25.3	10.9	37.6	43.8	36.8	East Wales
89.1	.	7.9	23.8	.	36.8	44.3	38.2	North Eastern Scotland
91.6	.	7.2	25.0	10.9	37.4	42.8	36.9	Eastern Scotland
90.6	.	7.7	24.2	14.0	37.7	46.0	36.9	South Western Scotland
85.6	.	8.1	29.2	.	37.8	46.6	36.9	Highlands, Islands
87.5	.	6.3	19.9	16.0	38.6	51.9	37.0	Northern Ireland

UNEMPLOYMENT

GRAPH 13: Unemployment rates by age group
(EU-15*, 1999)

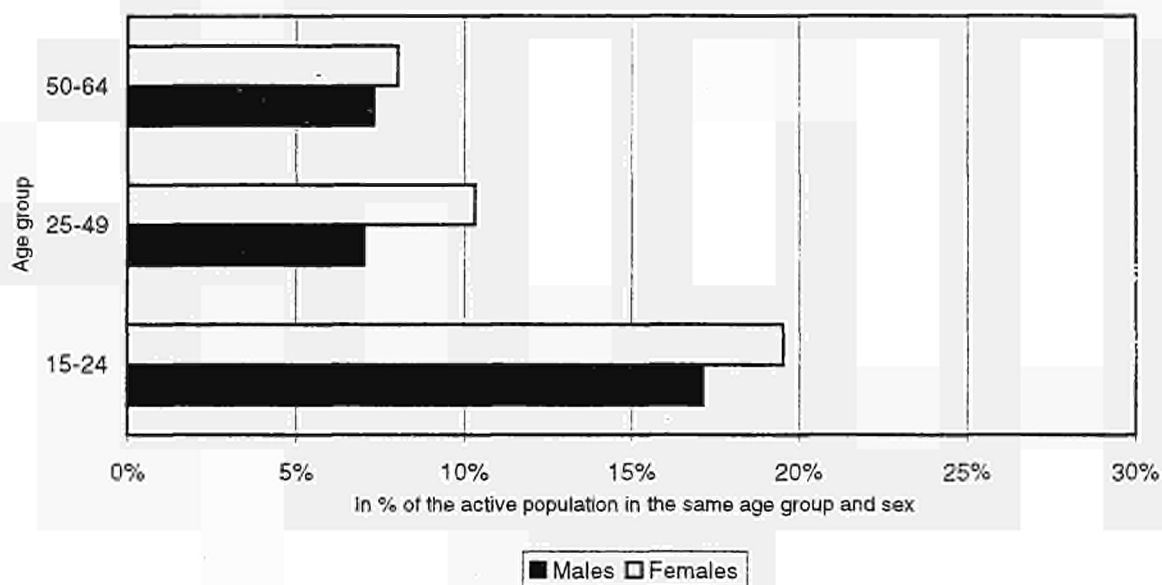

* Greece 1998

GRAPH 14: Unemployment rates by educational attainment level
(1999)

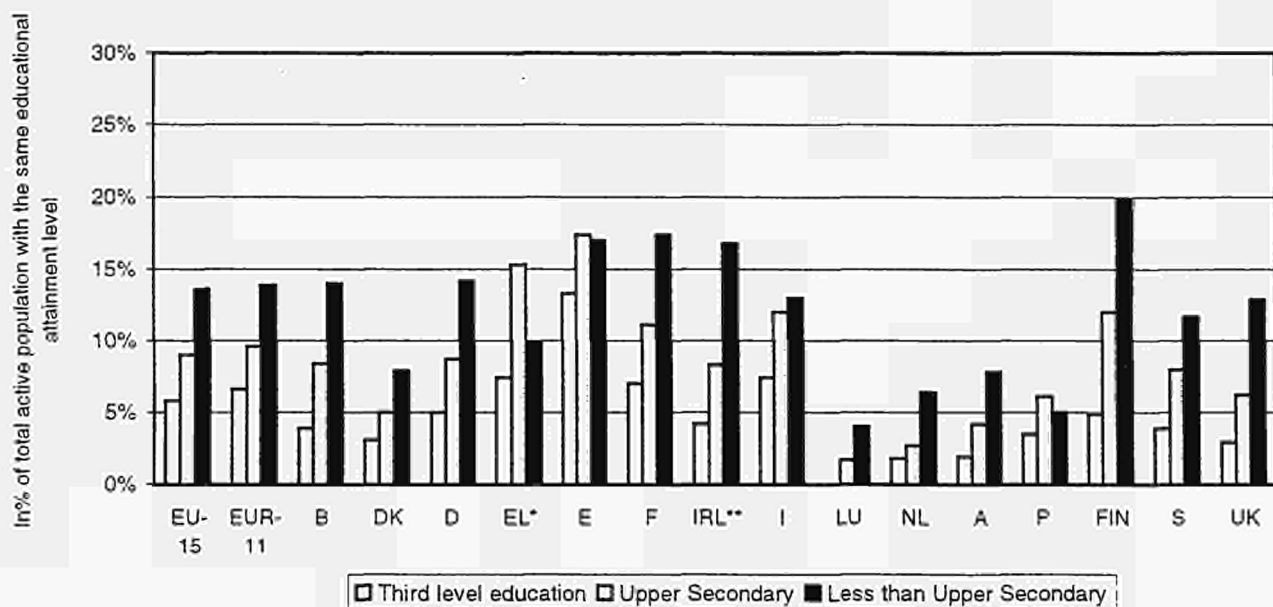

* 1998
** 1997

GRAPH 15: Previous work situation of the unemployed
(EU-15*, 1999)

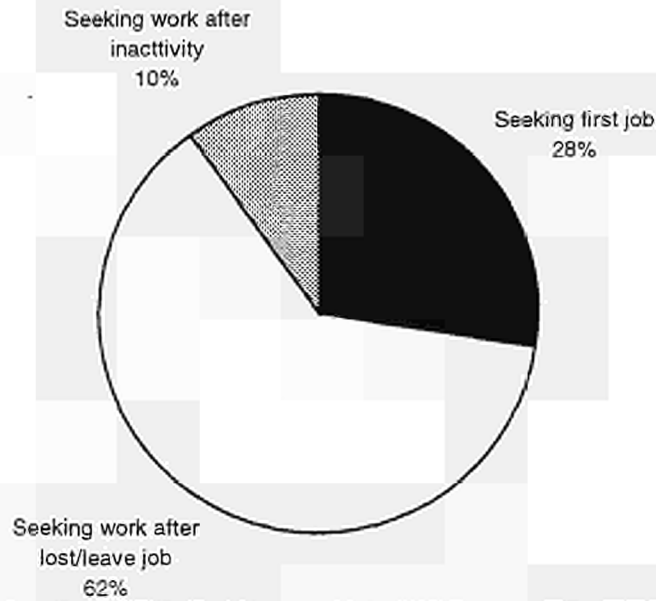

* Greece 1998

GRAPH 16: Methods used by the unemployed for seeking work
(EU-15*, 1999)

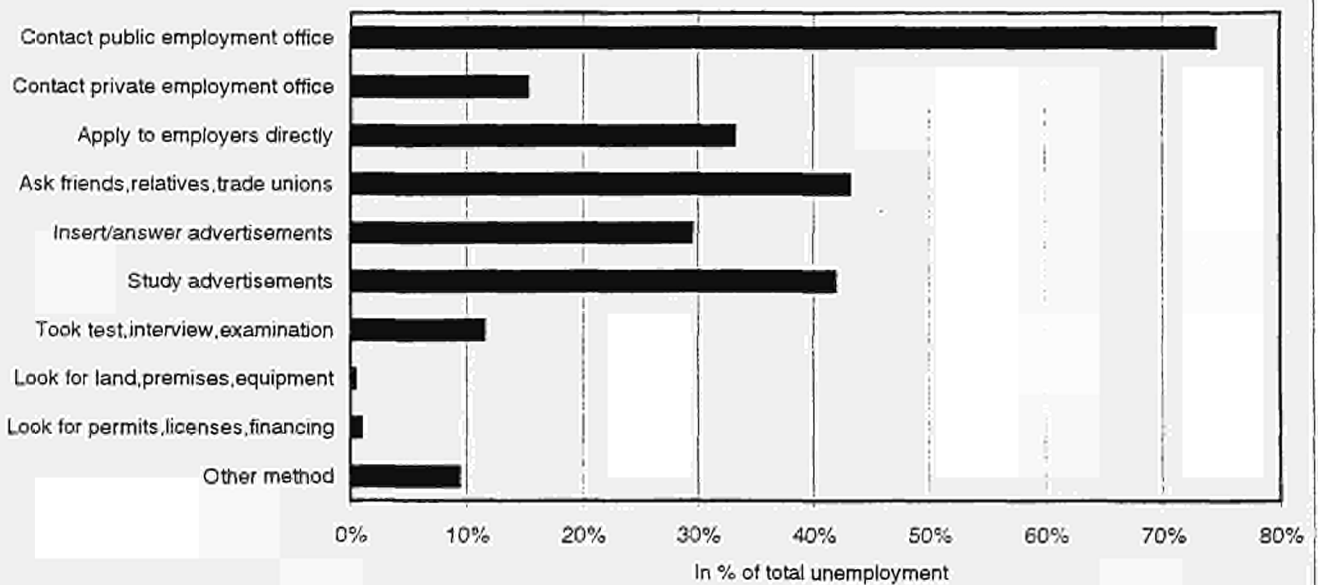

* Greece 1998

Table 53

Unemployment rates by age group and nationality

*Rates for the Male and/or Female active population in a given age group, Rates for the Male and/or Female active population in a given age group and with a given nationality

	EU-15 ⁽²⁾	EUR-11	B	DK	D	EL ⁽¹⁾	E	F
Males and Females								
15-24 years*	18.3	19.6	22.6	10.0	8.9	29.7	29.5	26.5
Nationals	18.2	19.6	21.5	9.9	7.8	30.2	29.5	26.0
Non-Nationals/EU-Nationals	.	16.1	28.8	.	15.2	.	.	(15.6)
Non-National/NonEU-Nationals	21.0	21.8	46.9	.	18.1	20.1	(22.3)	42.2
25-49 years*	8.4	9.2	7.6	4.2	7.9	9.5	14.4	11.0
Nationals	8.1	8.8	6.4	4.0	7.3	9.4	14.4	10.2
Non-Nationals/EU-Nationals	7.7	7.9	12.9	.	6.5	.	(11.4)	10.1
Non-National/NonEU-Nationals	18.7	19.8	35.3	17.7	17.7	11.7	13.1	30.4
50-64 years*	7.6	8.5	5.7	4.5	12.0	4.3	9.7	8.6
Nationals	7.2	8.1	5.2	4.3	11.4	4.2	9.6	7.8
Non-Nationals/EU-Nationals	9.8	10.6	(9.9)	.	12.4	.	.	10.5
Non-National/NonEU-Nationals	21.6	23.3	.	.	25.2	.	.	25.4
15-64 years*	9.5	10.3	8.7	5.2	8.9	11.0	15.8	12.1
Nationals	9.2	10.0	7.6	5.0	8.3	10.9	15.8	11.4
Non-Nationals/EU-Nationals	8.8	9.2	13.4	.	8.8	.	13.5	10.5
Non-National/NonEU-Nationals	19.4	20.6	35.8	16.5	18.9	13.2	14.7	30.5
Males								
15-24 years*	17.1	17.9	22.7	9.5	9.9	21.4	23.0	24.9
Nationals	17.0	17.7	21.4	9.5	8.4	21.6	23.0	24.5
Non-Nationals/EU-Nationals	.	.	(28.3)	.	18.3	.	.	.
Non-National/NonEU-Nationals	22.2	23.3	(48.7)	.	20.9	(17.5)	.	39.1
25-49 years*	7.0	7.4	6.3	3.7	7.4	5.9	9.3	9.0
Nationals	6.6	6.9	4.9	3.4	6.6	5.9	9.3	8.2
Non-Nationals/EU-Nationals	6.7	6.9	9.7	.	6.4	.	.	8.8
Non-National/NonEU-Nationals	17.9	18.7	33.2	.	17.7	7.2	10.4	27.0
50-64 years*	7.3	7.8	5.0	3.6	11.4	3.7	8.3	8.3
Nationals	6.8	7.3	4.3	3.3	10.6	3.6	8.3	7.0
Non-Nationals/EU-Nationals	.	10.5	(8.6)	.	11.7	.	.	12.5
Non-National/NonEU-Nationals	22.2	23.5	.	.	25.8	.	.	24.5
15-64 years*	8.3	8.7	7.5	4.5	8.6	7.2	11.0	10.5
Nationals	7.9	8.3	6.3	4.3	7.8	7.1	11.0	9.7
Non-Nationals/EU-Nationals	8.4	8.6	10.7	.	8.9	.	(8.5)	10.2
Non-National/NonEU-Nationals	19.1	20.1	34.3	(14.0)	19.5	9.7	13.4	27.4
Females								
15-24 years*	19.5	21.7	22.4	10.5	7.7	39.3	37.6	28.4
Nationals	19.6	21.8	21.5	10.3	7.0	39.9	37.7	27.9
Non-Nationals/EU-Nationals
Non-National/NonEU-Nationals	19.5	19.8	(44.2)	.	14.4	(24.6)	.	46.6
25-49 years*	10.3	11.5	9.2	4.8	8.5	14.6	21.7	13.3
Nationals	10.0	11.3	8.1	4.6	8.0	14.5	21.8	12.5
Non-Nationals/EU-Nationals	9.1	9.5	18.2	.	6.8	.	(17.1)	11.9
Non-National/NonEU-Nationals	20.1	21.7	40.6	(21.5)	17.7	18.3	16.4	35.9
50-64 years*	8.0	9.6	7.1	5.6	12.8	5.6	12.8	9.0
Nationals	7.8	9.4	6.8	5.5	12.4	5.6	12.8	8.7
Non-Nationals/EU-Nationals	14.1	.	.	(7.6)
Non-National/NonEU-Nationals	.	22.6	.	.	23.6	.	.	29.5
15-64 years*	11.1	12.5	10.3	5.9	9.3	16.8	23.1	14.0
Nationals	10.9	12.3	9.3	5.7	8.9	16.8	23.2	13.4
Non-Nationals/EU-Nationals	9.4	10.2	18.3	.	8.8	.	20.5	11.0
Non-National/NonEU-Nationals	20.0	21.4	39.4	(19.2)	17.8	18.6	16.3	36.5

(1) 1998.

(2) Greece 1998.

Table 53

Unemployment rates by age group and nationality

*Rates for the Male and/or Female active population in a given age group, Rates for the Male and/or Female active population in a given age group and with a given nationality

IRL	I	L	NL	A	P	FIN	S	UK	
Males and Females									
8.4	32.9	(6.7)	7.4	5.9	9.1	28.6	16.3	12.7	15-24 years*
8.4	33.1		7.1	5.5	8.9	28.6	16.0	12.7	Nationals
.	.	(6.6)	Non-Nationals/EU-Nationals
.	.	.	(21.3)	10.6	Non-National/NonEU-Nationals
5.3	10.2	2.1	3.0	4.4	4.2	8.8	7.1	5.2	25-49 years*
5.2	10.2	(1.3)	2.7	4.0	4.1	8.6	6.5	5.0	Nationals
.	.	(2.3)	6.9	Non-Nationals/EU-Nationals
.	6.0	.	19.4	9.7	12.9	26.5	28.0	12.0	Non-National/NonEU-Nationals
4.7	4.7	.	2.5	5.0	3.7	8.4	6.0	4.7	50-64 years*
4.6	4.7	.	2.5	4.9	3.7	8.2	5.8	4.6	Nationals
.	Non-Nationals/EU-Nationals
.	Non-National/NonEU-Nationals
5.8	11.8	2.4	3.6	4.7	4.9	11.8	7.7	6.2	15-64 years*
5.7	11.9	1.6	3.4	4.3	4.7	11.6	7.2	6.1	Nationals
(7.2)	.	2.9	(3.2)	7.4	Non-Nationals/EU-Nationals
.	6.7	(7.9)	18.5	9.5	14.3	27.6	28.4	11.5	Non-National/NonEU-Nationals
Males									
8.5	28.6	(6.1)	6.6	5.5	7.5	27.5	17.1	14.5	15-24 years*
8.4	28.8	.	6.4	5.2	7.2	27.5	16.9	14.6	Nationals
.	Non-Nationals/EU-Nationals
.	.	.	.	9.5	Non-National/NonEU-Nationals
5.6	7.4	(1.3)	2.2	4.4	3.6	7.9	7.7	5.7	25-49 years*
5.6	7.5	.	1.8	3.9	3.5	7.7	7.0	5.4	Nationals
.	Non-Nationals/EU-Nationals
.	(3.6)	.	20.2	9.2	.	(25.4)	29.7	13.1	Non-National/NonEU-Nationals
4.9	4.1	.	1.6	5.3	4.2	8.9	7.0	5.8	50-64 years*
4.9	4.2	.	1.5	5.3	4.2	8.7	6.9	5.7	Nationals
.	Non-Nationals/EU-Nationals
.	Non-National/NonEU-Nationals
6.0	9.0	1.7	2.7	4.7	4.4	11.1	8.4	7.0	15-64 years*
6.0	9.0	(1.1)	2.4	4.3	4.2	10.9	8.0	6.9	Nationals
.	.	(2.1)	7.4	Non-Nationals/EU-Nationals
.	(3.7)	.	18.4	8.9	(16.3)	(28.3)	29.3	12.3	Non-National/NonEU-Nationals
Females									
8.3	38.3	(7.3)	8.2	6.4	11.1	29.7	15.4	10.5	15-24 years*
8.3	38.5	.	7.8	5.8	10.9	29.9	15.0	10.5	Nationals
.	Non-Nationals/EU-Nationals
.	.	.	.	11.7	Non-National/NonEU-Nationals
4.8	14.4	3.1	4.1	4.5	4.8	9.8	6.5	4.6	25-49 years*
4.7	14.5	(2.0)	3.8	4.1	4.7	9.6	5.8	4.4	Nationals
.	.	(3.4)	8.2	Non-Nationals/EU-Nationals
.	(10.5)	.	(17.7)	10.5	.	(27.5)	26.1	10.3	Non-National/NonEU-Nationals
(4.1)	6.1	.	4.4	4.4	3.0	8.0	4.8	3.2	50-64 years*
(3.9)	6.0	.	4.4	4.3	3.0	7.8	4.6	3.2	Nationals
.	Non-Nationals/EU-Nationals
.	Non-National/NonEU-Nationals
5.5	16.4	3.3	4.9	4.8	5.4	12.5	6.9	5.3	15-64 years*
5.4	16.4	(2.1)	4.7	4.4	5.3	12.3	6.4	5.1	Nationals
.	.	(3.9)	7.3	Non-Nationals/EU-Nationals
.	12.4	.	(18.6)	10.4	(12.1)	(26.6)	27.4	10.5	Non-National/NonEU-Nationals

(1) 1998.

(2) Greece 1998.

Table 54

Unemployment rates by age group and educational attainment level

*Rates for the Male and/or Female active population in a given age group, Rates for the Male and/or Female active population in a given age group and with a given educational attainment level

	EU-15 ⁽³⁾	EUR-11 ⁽⁴⁾	B	DK	D	EL ⁽²⁾	E	F
Males and Females								
15-24 years*	18.4	19.8	22.6	10.0	8.9	29.7	29.5	26.5
Less than upper secondary (L)	21.6	21.3	30.4	9.1	9.9	24.6	27.7	35.7
Upper secondary level (M)	16.8	18.6	20.1	10.6	7.9	32.2	32.3	24.2
Third level (H)	15.3	19.6	14.4	.	7.3	34.0	31.0	16.9
25-49 years*	8.5	9.2	7.6	4.2	7.9	9.5	14.4	11.0
Less than upper secondary (L)	13.0	13.3	13.3	7.6	15.1	9.6	16.2	16.8
Upper secondary level (M)	7.5	8.1	6.8	3.8	7.7	11.0	13.8	9.6
Third level (H)	5.3	6.0	3.2	3.1	4.1	6.9	11.7	6.5
50-59 years*	7.9	9.0	6.2	4.8	12.6	4.8	10.2	8.9
Less than upper secondary (L)	9.5	10.2	8.4	6.3	17.6	4.8	11.5	11.4
Upper secondary level (M)	8.1	9.4	6.2	5.1	13.1	6.7	8.5	8.1
Third level (H)	4.6	5.3	2.9	3.0	7.9	.	5.3	4.3
15-59 years*	9.7	10.5	8.8	5.3	9.0	11.5	16.1	12.2
Less than upper secondary (L)	13.6	13.9	14.0	7.9	14.2	9.9	17.0	17.4
Upper secondary level (M)	9.0	9.6	8.4	5.0	8.7	15.3	17.4	11.1
Third level (H)	5.8	6.6	3.8	3.1	5.0	7.4	13.3	7.0
Males								
15-24 years*	17.3	18.1	22.7	9.5	9.9	21.4	23.0	24.9
Less than upper secondary (L)	19.7	19.4	30.3	6.8	10.2	18.7	22.1	32.8
Upper secondary level (M)	15.9	16.9	18.9	13.4	9.5	23.5	25.7	21.5
Third level (H)	13.2	17.0	(14.3)	.	.	.	22.7	16.1
25-49 years*	7.1	7.4	6.3	3.7	7.4	5.9	9.3	9.0
Less than upper secondary (L)	10.7	10.6	10.6	7.5	16.5	6.0	10.7	14.8
Upper secondary level (M)	6.2	6.4	5.2	3.2	7.1	6.6	7.9	7.1
Third level (H)	4.1	4.5	2.3	2.6	3.4	4.6	7.2	5.5
50-59 years*	7.5	8.2	5.4	3.9	11.9	3.9	8.7	8.5
Less than upper secondary (L)	8.9	9.2	7.4	.	18.9	3.9	9.7	11.6
Upper secondary level (M)	7.7	8.5	5.0	4.2	12.6	5.3	6.6	7.2
Third level (H)	4.8	5.2	(2.8)	.	7.5	.	5.3	4.5
15-59 years*	8.4	8.8	7.7	4.6	8.6	7.4	11.2	10.6
Less than upper secondary (L)	11.8	11.8	11.9	6.9	15.0	6.9	12.2	16.2
Upper secondary level (M)	7.8	8.0	6.9	4.5	8.4	9.6	11.2	8.8
Third level (H)	4.7	5.1	3.0	2.6	4.5	4.5	8.4	6.0
Females								
15-24 years*	19.7	21.8	22.4	10.5	7.7	39.3	37.6	28.4
Less than upper secondary (L)	24.3	24.2	30.7	12.0	9.5	37.8	37.1	40.6
Upper secondary level (M)	17.7	20.3	21.6	8.3	6.2	40.1	39.1	27.2
Third level (H)	16.9	21.2	14.3	.	.	36.5	36.8	17.4
25-49 years*	10.3	11.6	9.2	4.8	8.5	14.6	21.7	13.3
Less than upper secondary (L)	16.4	17.2	18.0	7.6	13.7	15.8	25.7	19.2
Upper secondary level (M)	9.1	10.1	8.7	4.7	8.4	17.1	21.5	12.8
Third level (H)	6.6	7.8	4.0	3.6	5.1	9.7	16.5	7.6
50-59 years*	8.5	10.2	7.5	5.8	13.6	6.7	13.6	9.4
Less than upper secondary (L)	10.4	11.7	10.0	7.1	16.6	6.6	15.7	11.3
Upper secondary level (M)	8.7	10.7	8.7	6.3	13.8	(10.4)	12.6	9.3
Third level (H)	4.4	5.4	.	.	8.9	.	5.3	4.2
15-59 years*	11.3	12.7	10.3	6.0	9.4	17.5	23.5	14.2
Less than upper secondary (L)	16.3	17.2	17.7	9.0	13.4	15.4	25.7	18.8
Upper secondary level (M)	10.4	11.7	10.4	5.6	9.1	23.0	25.3	14.2
Third level (H)	7.1	8.5	4.6	3.6	5.8	11.1	18.7	8.1

(1) 1998.

(2) 1997.

(3) Greece 1998, Ireland 1997.

(4) Ireland 1997.

Table 54

Unemployment rates by age group and educational attainment level

*Rates for the Male and/or Female active population in a given age group, Rates for the Male and/or Female active population in a given age group and with a given educational attainment level⁽¹⁾

IRL ⁽²⁾	I	L	NL	A	P	FIN	S	UK	
Males and Females									
15.9	32.9	(6.7)	7.4	5.9	9.1	28.6	16.3	12.7	15-24 years*
26.7	31.6	.	10.3	7.2	8.7	40.4	22.3	31.1	Less than upper secondary (L)
12.9	34.3	(6.9)	4.8	5.2	9.2	22.3	15.3	11.4	Upper secondary level (M)
7.4	29.9	.	.	.	14.4	.	.	5.4	Third level (H)
9.5	10.2	2.1	3.0	4.4	4.2	8.8	7.1	5.2	25-49 years*
16.4	11.7	4.0	5.7	8.3	4.2	14.6	12.6	12.3	Less than upper secondary (L)
6.7	8.9	(1.1)	2.3	3.8	4.9	9.7	7.3	4.9	Upper secondary level (M)
3.5	8.5	.	1.7	2.2	2.8	4.9	4.1	2.7	Third level (H)
7.9	4.9	.	2.5	5.2	3.8	8.5	5.3	4.6	50-59 years*
10.3	6.5	.	2.8	6.9	4.2	11.9	6.0	7.0	Less than upper secondary (L)
.	2.3	.	2.5	5.3	(7.9)	8.7	6.0	4.4	Upper secondary level (M)
.	.	.	(2.0)	.	.	4.1	3.5	2.9	Third level (H)
10.6	12.0	2.4	3.7	4.8	4.9	11.9	7.6	6.3	15-59 years*
16.8	13.0	4.0	6.4	7.8	5.0	19.9	11.7	12.9	Less than upper secondary (L)
8.3	12.0	(1.7)	2.7	4.2	6.1	12.0	8.0	6.2	Upper secondary level (M)
4.2	7.4	.	1.8	1.9	3.5	4.9	3.9	2.9	Third level (H)
Males									
16.7	28.6	(6.1)	6.6	5.5	7.5	27.5	17.1	14.5	15-24 years*
26.3	28.3	.	8.8	6.2	7.3	37.6	24.6	31.2	Less than upper secondary (L)
12.5	28.9	.	4.0	5.1	7.4	21.2	15.1	13.1	Upper secondary level (M)
.	(25.5)	6.8	Third level (H)
9.6	7.4	(1.3)	2.2	4.4	3.6	7.9	7.7	5.7	25-49 years*
16.0	8.2	(2.9)	4.3	10.1	3.7	12.1	11.4	15.6	Less than upper secondary (L)
5.5	6.4	.	1.4	3.6	3.3	9.3	7.9	5.2	Upper secondary level (M)
3.0	6.3	.	1.5	2.3	3.5	2.9	5.2	2.8	Third level (H)
8.2	4.2	.	1.5	5.6	4.3	9.1	6.5	5.6	50-59 years*
10.3	5.5	.	.	8.2	4.5	13.0	6.6	9.5	Less than upper secondary (L)
.	2.2	.	(1.4)	5.7	(10.4)	9.5	7.5	5.3	Upper secondary level (M)
.	(4.0)	.	3.5	Third level (H)
10.7	9.1	1.8	2.7	4.7	4.4	11.2	8.4	7.0	15-59 years*
16.3	9.9	(3.1)	4.9	8.6	4.4	18.2	11.4	16.3	Less than upper secondary (L)
7.4	8.8	(1.1)	1.8	4.1	4.9	11.5	8.7	6.9	Upper secondary level (M)
3.7	5.3	.	1.5	2.0	3.7	3.4	5.0	3.3	Third level (H)
Females									
14.9	38.3	(7.3)	8.2	6.4	11.1	29.7	15.4	10.5	15-24 years*
27.4	37.1	.	12.2	8.8	10.8	43.5	19.8	30.8	Less than upper secondary (L)
13.3	39.5	.	5.4	5.3	10.6	23.6	15.5	9.4	Upper secondary level (M)
(7.4)	32.5	.	.	.	(13.6)	.	.	3.9	Third level (H)
9.3	14.4	3.1	4.1	4.5	4.8	9.8	6.5	4.6	25-49 years*
17.4	18.9	(5.5)	7.6	6.9	4.8	18.2	14.3	9.1	Less than upper secondary (L)
8.1	12.1	.	3.3	4.2	6.5	10.2	6.7	4.6	Upper secondary level (M)
4.1	10.8	.	2.0	2.0	2.4	6.4	3.1	2.5	Third level (H)
(7.0)	6.4	.	4.2	4.6	3.1	7.9	4.1	3.4	50-59 years*
(10.3)	8.7	.	(4.4)	5.6	3.7	10.9	.	4.9	Less than upper secondary (L)
.	2.5	.	(4.5)	4.5	.	8.0	4.5	3.0	Upper secondary level (M)
.	(4.0)	.	.	Third level (H)
10.3	16.6	3.3	4.9	4.8	5.6	12.6	6.8	5.4	15-59 years*
18.1	19.4	(5.1)	8.3	7.0	5.7	21.9	12.1	9.6	Less than upper secondary (L)
9.4	16.0	(2.6)	3.9	4.4	7.4	12.6	7.2	5.4	Upper secondary level (M)
4.7	10.0	.	2.1	1.9	3.4	6.0	2.9	2.6	Third level (H)

⁽¹⁾ Non responses to the variable HIGHER LEVEL OF EDUCATION ATTAINED not considered.

⁽²⁾ 1998.

⁽³⁾ 1997.

⁽⁴⁾ Greece 1998, Ireland 1997.

⁽⁵⁾ Ireland 1997.

Table 55

Principal characteristics of unemployment

Thousands

	EU-15 ⁽²⁾	EUR-11	B	DK	D	EL ⁽¹⁾	E	F
Males and Females								
All in unemployment	16 157	13 417	378	147	3 506	478	2 566	3 127
Seeking work as Employee	15 438	12 964	367	138	3 368	466	2 557	3 029
Seeking self-employment	270	193	10	(4)	10	12	7	77
Job found to start later	954	842	19	22	219	10	90	354
Seeking work after lost/leave job	7 367	6 445	143	97	1 912	146	1 430	1 770
Seeking first job	3 266	2 765	73	5	194	229	593	333
Seeking work after inactivity	1 190	862	27	17	294	27	70	188
Registered as unemployed	10 216	9 043	317	97	3 219	79	2 068	2 758
Receiving benefits/assistance	6 217	5 120	252	93	2 614	41	428	1 348
All in unemployment aged 15-24	3 958	3 127	93	44	396	169	735	692
Seeking work as Employee	3 784	3 027	90	42	360	166	733	677
Seeking self-employment	(3)	.	(8)
Job found to start later	250	206	9	11	45	(3)	31	74
Seeking work after lost/leave job	1 210	1 006	26	23	158	21	312	301
Seeking first job	1 878	1 526	43	(4)	97	132	346	234
Seeking work after inactivity	201	140	5	5	29	5	14	34
Registered as unemployed	1 912	1 656	69	13	326	18	555	568
Receiving benefits/assistance	761	525	44	12	214	5	41	168
Males								
All in unemployment	8 024	6 463	186	69	1 907	188	1 078	1 471
Seeking work as Employee	7 589	6 203	181	63	1 835	181	1 073	1 406
Seeking self-employment	185	130	6	.	.	8	(4)	55
Job found to start later	454	402	10	7	111	5	42	157
Seeking work after lost/leave job	4 033	3 397	78	50	1 090	74	683	901
Seeking first job	1 390	1 157	34	(3)	101	74	191	144
Seeking work after inactivity	540	396	15	6	151	10	27	92
Registered as unemployed	5 335	4 511	161	47	1 779	33	886	1 329
Receiving benefits/assistance	3 622	2 832	130	46	1 497	20	251	682
All in unemployment aged 15-24	2 004	1 539	51	21	234	65	318	354
Seeking work as Employee	1 902	1 484	49	20	216	63	317	345
Seeking self-employment	(6)
Job found to start later	130	112	6	(3)	24	.	16	39
Seeking work after lost/leave job	674	530	15	13	99	9	149	163
Seeking first job	874	692	22	.	52	49	130	111
Seeking work after inactivity	91	68	(3)	(3)	14	(3)	9	18
Registered as unemployed	1 010	835	38	7	199	5	242	291
Receiving benefits/assistance	473	304	24	6	139	.	20	91
Females								
All in unemployment	8 133	6 954	191	78	1 599	290	1 488	1 657
Seeking work as Employee	7 849	6 761	187	75	1 533	285	1 483	1 623
Seeking self-employment	85	63	(4)	.	.	5	(3)	22
Job found to start later	500	441	10	15	108	5	48	197
Seeking work after lost/leave job	3 334	3 048	65	47	822	72	747	869
Seeking first job	1 876	1 608	38	.	93	155	402	189
Seeking work after inactivity	650	466	13	11	143	16	43	96
Registered as unemployed	4 880	4 532	156	50	1 439	46	1 182	1 429
Receiving benefits/assistance	2 595	2 289	122	47	1 117	21	176	666
All in unemployment aged 15-24	1 955	1 588	41	23	162	104	417	339
Seeking work as Employee	1 882	1 543	41	22	144	103	416	332
Seeking self-employment
Job found to start later	120	95	(3)	8	21	.	15	35
Seeking work after lost/leave job	536	476	11	10	58	13	163	139
Seeking first job	1 004	834	21	.	46	83	216	123
Seeking work after inactivity	110	71	.	.	15	.	6	17
Registered as unemployed	901	822	31	6	126	13	313	277
Receiving benefits/assistance	287	221	20	6	75	(3)	20	78

⁽¹⁾ 1998.⁽²⁾ Greece 1998.

Table 55

Principal characteristics of unemployment

Thousands

IRL	I	L	NL	A	P	FIN	S	UK	
Males and Females									
96	2 729	4	286	181	233	309	334	1 782	All in unemployment
93	2 582	4	274	176	210	304	299	1 570	Seeking work as Employee
(3)	53	.	12	5	12	5	.	59	Seeking self-employment
.	120	.	22	4	7	7	.	71	Job found to start later
.	717	2	61	90	117	202	18	662	Seeking work after lost/leave job
.	1 377	(1)	95	17	33	50	20	246	Seeking first job
.	192	(1)	19	32	14	25	.	280	Seeking work after inactivity
.	.	2	140	156	160	222	217	780	Registered as unemployed
.	.	(1)	97	137	64	179	184	780	Receiving benefits/assistance
28	873	(1)	93	32	69	115	70	548	All in unemployment aged 15-24
28	836	(1)	93	32	63	115	64	485	Seeking work as Employee
.	12	.	.	.	(3)	.	.	.	Seeking self-employment
.	30	.	(10)	.	.	(4)	.	27	Job found to start later
.	119	.	(6)	13	23	49	.	156	Seeking work after lost/leave job
.	654	(1)	71	10	25	45	.	207	Seeking first job
.	33	.	.	4	5	12	.	51	Seeking work after inactivity
.	.	(1)	27	27	38	46	24	202	Registered as unemployed
.	.	.	10	19	6	23	18	202	Receiving benefits/assistance
Males									
59	1 272	2	121	101	115	151	192	1 113	All in unemployment
57	1 186	2	114	97	103	149	171	971	Seeking work as Employee
.	36	.	(7)	4	7	.	.	44	Seeking self-employment
.	65	.	(8)	3	(3)	(3)	.	35	Job found to start later
.	385	(1)	35	60	63	101	10	502	Seeking work after lost/leave job
.	598	.	45	6	13	24	11	146	Seeking first job
.	74	.	(10)	12	6	11	.	125	Seeking work after inactivity
.	.	(1)	77	92	76	110	129	616	Registered as unemployed
.	.	(1)	59	85	35	91	109	616	Receiving benefits/assistance
15	421	(1)	42	16	31	57	38	340	All in unemployment aged 15-24
15	398	.	42	16	29	57	36	299	Seeking work as Employee
.	8	Seeking self-employment
.	18	.	(6)	12	Job found to start later
.	58	.	.	8	11	25	.	119	Seeking work after lost/leave job
.	311	.	30	4	10	22	.	126	Seeking first job
.	14	6	.	17	Seeking work after inactivity
.	.	.	11	13	16	25	14	151	Registered as unemployed
.	.	.	.	10	.	13	11	151	Receiving benefits/assistance
Females									
37	1 457	2	165	81	119	158	142	669	All in unemployment
36	1 395	2	160	79	107	155	128	599	Seeking work as Employee
.	17	.	(5)	.	5	.	.	15	Seeking self-employment
.	55	.	14	.	(4)	(4)	.	36	Job found to start later
.	332	(1)	26	30	54	101	.	160	Seeking work after lost/leave job
.	778	(1)	50	11	20	26	10	101	Seeking first job
.	119	.	(9)	20	8	15	.	154	Seeking work after inactivity
.	.	(1)	63	64	85	112	89	164	Registered as unemployed
.	.	(1)	38	52	29	88	75	164	Receiving benefits/assistance
13	453	(1)	51	16	38	58	32	208	All in unemployment aged 15-24
12	439	(1)	51	16	34	58	29	186	Seeking work as Employee
.	(4)	Seeking self-employment
.	12	15	Job found to start later
.	61	.	.	5	12	24	.	37	Seeking work after lost/leave job
.	343	.	41	7	14	23	.	82	Seeking first job
.	19	.	.	3	(4)	6	.	34	Seeking work after inactivity
.	.	.	15	13	23	22	10	51	Registered as unemployed
.	.	.	(6)	9	(4)	10	.	51	Receiving benefits/assistance

(1) 1998.

(2) Greece 1998.

Table 56

Unemployment by age group and nationality

Thousands

	EU-15 ⁽²⁾	EUR-11	B	DK	D	EL ⁽¹⁾	E	F
Males and Females								
15-24 years	3 958	3 127	93	44	396	169	735	692
Nationals	3 762	2 955	82	43	306	162	729	648
Non-Nationals/EU-Nationals	.	33	5	.	18	.	.	(5)
Non-National/NonEU-Nationals	158	139	6	.	73	6	(4)	39
Non responses	0	0	0	0	0	0	0	0
25-49 years	9 564	8 103	245	72	2 044	268	1 528	2 032
Nationals	8 704	7 368	187	67	1 715	254	1 508	1 774
Non-Nationals/EU-Nationals	155	130	27	.	46	.	(5)	42
Non-National/NonEU-Nationals	705	606	32	5	282	14	15	216
Non responses	0	0	0	0	0	0	0	0
50-64 years	2 604	2 170	39	30	1 063	40	302	402
Nationals	2 377	1 963	33	28	937	39	299	338
Non-Nationals/EU-Nationals	65	54	(4)	.	30	.	.	16
Non-National/NonEU-Nationals	162	153	.	.	96	.	.	49
Non responses	0	0	0	0	0	0	0	0
15-64 years	16 127	13 400	377	147	3 502	477	2 565	3 126
Nationals	14 843	12 286	301	138	2 957	454	2 536	2 760
Non-Nationals/EU-Nationals	259	217	36	.	94	.	9	62
Non-National/NonEU-Nationals	1 025	897	40	8	451	21	20	304
Non responses	0	0	0	0	0	0	0	0
Males								
15-24 years	2 004	1 539	51	21	234	65	318	354
Nationals	1 888	1 436	44	21	175	61	315	329
Non-Nationals/EU-Nationals	.	.	(3)	.	12	.	.	.
Non-National/NonEU-Nationals	92	83	(4)	.	48	(4)	.	22
Non responses	0	0	0	0	0	0	0	0
25-49 years	4 484	3 684	112	34	1 069	99	578	903
Nationals	3 983	3 251	78	31	856	94	570	764
Non-Nationals/EU-Nationals	78	67	13	.	28	.	.	21
Non-National/NonEU-Nationals	423	365	21	.	185	5	6	118
Non responses	0	0	0	0	0	0	0	0
50-64 years	1 517	1 231	22	13	601	23	181	213
Nationals	1 356	1 082	18	12	513	22	179	163
Non-Nationals/EU-Nationals	.	36	(3)	.	20	.	.	11
Non-National/NonEU-Nationals	119	113	.	.	69	.	.	39
Non responses	0	0	0	0	0	0	0	0
15-64 years	8 005	6 454	186	68	1 904	187	1 077	1 469
Nationals	7 227	5 768	140	64	1 544	178	1 064	1 256
Non-Nationals/EU-Nationals	144	124	19	.	59	.	(3)	35
Non-National/NonEU-Nationals	634	562	27	(4)	301	9	10	178
Non responses	0	0	0	0	0	0	0	0
Females								
15-24 years	1 955	1 588	41	23	162	104	417	339
Nationals	1 873	1 520	37	22	131	101	414	319
Non-Nationals/EU-Nationals
Non-National/NonEU-Nationals	66	55	(3)	.	25	(3)	.	18
Non responses	0	0	0	0	0	0	0	0
25-49 years	5 080	4 419	133	39	974	169	949	1 129
Nationals	4 721	4 117	108	36	859	160	938	1 011
Non-Nationals/EU-Nationals	76	62	14	.	18	.	(3)	20
Non-National/NonEU-Nationals	283	240	11	(3)	97	9	8	98
Non responses	0	0	0	0	0	0	0	0
50-64 years	1 087	939	17	16	462	17	121	189
Nationals	1 022	881	16	16	424	17	120	175
Non-Nationals/EU-Nationals	11	.	.	(5)
Non-National/NonEU-Nationals	.	39	.	.	27	.	.	10
Non responses	0	0	0	0	0	0	0	0
15-64 years	8 122	6 946	191	78	1 598	289	1 488	1 657
Nationals	7 616	6 518	161	74	1 414	277	1 472	1 505
Non-Nationals/EU-Nationals	114	93	17	.	35	.	5	27
Non-National/NonEU-Nationals	391	335	13	(4)	149	12	10	125
Non responses	0	0	0	0	0	0	0	0

(1) 1998.

(2) Greece 1998.

Table 56

Unemployment by age group and nationality

Thousands

IRL	I	L	NL	A	P	FIN	S	UK	
Males and Females									
28	873	(1)	93	32	69	115	70	548	15-24 years
27	870	.	87	26	66	114	67	534	Nationals
.	.	(1)	Non-Nationals/EU-Nationals
.	.	.	(6)	6	Non-National/NonEU-Nationals
0	0	0	0	0	0	0	0	0	Non responses
55	1 650	3	158	118	128	145	188	932	25-49 years
52	1 639	(1)	137	94	122	139	163	852	Nationals
.	.	(1)	21	Non-Nationals/EU-Nationals
.	10	.	18	22	5	5	22	59	Non-National/NonEU-Nationals
0	0	0	0	0	0	0	0	0	Non responses
13	197	.	35	32	37	49	74	290	50-64 years
13	196	.	33	30	37	48	70	277	Nationals
.	Non-Nationals/EU-Nationals
.	Non-National/NonEU-Nationals
0	0	0	0	0	0	0	0	0	Non responses
96	2 720	4	286	181	233	309	333	1 771	15-64 years
92	2 705	2	257	150	225	301	300	1 664	Nationals
(3)	.	2	(5)	35	Non-Nationals/EU-Nationals
.	13	(1)	24	30	7	7	28	72	Non-National/NonEU-Nationals
0	0	0	0	0	0	0	0	0	Non responses
Males									
15	421	(1)	42	16	31	57	38	340	15-24 years
15	419	.	40	13	29	56	37	334	Nationals
.	.	.	.	3	Non-Nationals/EU-Nationals
.	Non-National/NonEU-Nationals
0	0	0	0	0	0	0	0	0	Non responses
34	729	(1)	65	64	60	69	107	560	25-49 years
32	725	.	52	50	57	65	93	513	Nationals
.	Non-Nationals/EU-Nationals
.	(4)	.	12	12	.	(3)	12	38	Non-National/NonEU-Nationals
0	0	0	0	0	0	0	0	0	Non responses
10	119	.	14	21	24	26	46	204	50-64 years
9	119	.	13	20	24	25	44	196	Nationals
.	Non-Nationals/EU-Nationals
.	Non-National/NonEU-Nationals
0	0	0	0	0	0	0	0	0	Non responses
59	1 269	2	121	101	114	151	191	1 104	15-64 years
57	1 263	(1)	104	83	110	147	174	1 043	Nationals
.	.	(1)	18	Non-Nationals/EU-Nationals
.	(5)	.	15	16	(4)	(4)	16	44	Non-National/NonEU-Nationals
0	0	0	0	0	0	0	0	0	Non responses
Females									
13	453	(1)	51	16	38	58	32	208	15-24 years
12	451	.	47	13	37	58	30	201	Nationals
.	.	.	.	3	Non-Nationals/EU-Nationals
.	Non-National/NonEU-Nationals
0	0	0	0	0	0	0	0	0	Non responses
21	920	2	93	54	68	76	81	372	25-49 years
19	914	(1)	85	44	66	73	70	339	Nationals
.	.	(1)	12	Non-Nationals/EU-Nationals
.	(6)	.	(6)	10	.	(3)	10	21	Non-National/NonEU-Nationals
0	0	0	0	0	0	0	0	0	Non responses
(4)	78	.	21	11	13	23	29	86	50-64 years
(4)	77	.	21	10	13	23	27	81	Nationals
.	Non-Nationals/EU-Nationals
.	Non-National/NonEU-Nationals
0	0	0	0	0	0	0	0	0	Non responses
37	1 451	2	165	81	119	158	142	666	15-64 years
35	1 442	(1)	153	67	115	154	126	621	Nationals
.	.	(1)	17	Non-Nationals/EU-Nationals
.	8	.	(9)	13	(3)	(3)	13	28	Non-National/NonEU-Nationals
0	0	0	0	0	0	0	0	0	Non responses

(1) 1998.

(2) Greece 1998.

Table 57⁽¹⁾

Unemployment by duration

Percentages of the Male and/or Female population in unemployment

	EU-15 ⁽⁴⁾	EUR-11 ⁽⁵⁾	B	DK	D	EL ⁽²⁾	E	F
Males and Females								
From 1 to 2 months	13.2	12.3	9.3	16.8	10.9	7.3	13.1	15.8
From 3 to 5 months	15.4	14.7	10.0	17.5	15.1	13.4	15.0	17.1
From 6 to 11 months	16.5	16.4	13.0	17.3	15.4	19.9	19.3	14.3
From 12 to 17 months	9.3	9.4	9.3	7.2	10.2	11.1	8.8	10.9
From 18 to 23 months	7.6	7.8	7.3	4.0	8.7	8.2	6.6	5.7
From 24 to 47 months	14.7	15.3	17.6	6.3	14.6	35.5	13.6	16.6
Less than 1 month	8.8	8.1	7.3	28.0	6.8	4.4	6.6	14.3
Less than 6 months	37.5	35.0	26.5	62.2	32.8	25.2	34.7	47.2
Less than 12 months	54.0	51.4	39.6	79.5	48.3	45.1	54.0	61.4
12 months and more	46.0	48.6	60.4	20.5	51.7	54.9	46.0	38.6
24 months and more	29.2	31.4	43.8	9.3	32.9	35.6	30.7	22.0
48 months and more	14.5	16.1	26.2	(2.9)	18.3	.	17.1	5.3
Males								
From 1 to 2 months	14.1	13.4	9.8	15.8	11.7	9.3	15.5	17.5
From 3 to 5 months	16.3	15.5	10.2	15.9	16.0	16.0	17.2	17.1
From 6 to 11 months	15.9	15.7	13.3	17.5	15.4	24.2	19.0	14.0
From 12 to 17 months	9.2	9.4	9.7	8.2	10.4	10.3	8.2	10.6
From 18 to 23 months	7.4	7.4	9.3	(4.5)	8.4	7.4	6.2	5.7
From 24 to 47 months	14.0	15.1	15.0	(5.0)	14.7	27.0	12.1	16.0
Less than 1 month	8.9	8.3	7.0	29.9	7.1	5.7	8.4	13.8
Less than 6 months	39.3	37.1	27.0	61.6	34.7	31.1	41.1	48.4
Less than 12 months	55.2	52.9	40.4	79.1	50.1	55.3	60.1	62.4
12 months and more	44.8	47.1	59.6	20.9	49.9	44.7	39.9	37.6
24 months and more	28.2	30.3	40.7	8.0	31.1	27.0	25.4	21.3
48 months and more	14.2	15.2	25.7	.	16.4	.	13.4	5.3
Females								
From 1 to 2 months	12.4	11.2	8.8	17.7	10.1	6.0	11.3	14.2
From 3 to 5 months	14.5	13.9	9.7	18.9	14.0	11.7	13.4	17.1
From 6 to 11 months	17.0	17.0	12.8	17.1	15.4	17.1	19.5	14.5
From 12 to 17 months	9.3	9.5	9.0	6.2	9.9	11.7	9.2	11.1
From 18 to 23 months	7.8	8.1	5.4	(3.3)	9.0	8.7	6.8	5.7
From 24 to 47 months	15.4	15.6	20.1	7.5	14.4	41.1	14.6	17.2
Less than 1 month	8.8	7.9	7.6	26.2	6.5	3.6	5.3	14.8
Less than 6 months	35.7	33.0	26.1	62.8	30.6	21.4	30.0	46.1
Less than 12 months	52.7	50.0	38.8	79.9	46.0	38.5	49.5	60.6
12 months and more	47.3	50.0	61.2	20.1	54.0	61.5	50.5	39.4
24 months and more	30.2	32.4	46.8	10.5	35.0	41.1	34.5	22.6
48 months and more	14.9	16.8	26.7	.	20.7	.	19.9	5.4

⁽¹⁾ These percentages were calculated using data from the NEWCRONOS table *u_ga_d*. Non responses to the variable DURATION OF SEARCH FOR EMPLOYMENT not considered.

⁽²⁾ 1998.

⁽³⁾ 1997.

⁽⁴⁾ Greece 1998, Ireland 1997.

⁽⁵⁾ Ireland 1997.

(a) Table 57

Unemployment by duration

Percentages of the Male and/or Female population in unemployment

IRL ⁽³⁾	I	L	NL	A	P	FIN	S	UK	
Males and Females									
8.0	7.3	(14.1)	8.3	27.4	13.6	27.3	12.9	21.9	From 1 to 2 months
11.2	10.8	(21.6)	7.2	24.9	16.7	21.7	29.2	18.8	From 3 to 5 months
13.1	15.8	(21.4)	37.3	15.1	22.7	14.4	17.6	15.7	From 6 to 11 months
9.3	7.7	.	5.4	10.8	14.4	5.5	8.8	7.6	From 12 to 17 months
6.4	10.4	.	13.2	5.9	6.4	3.9	20.3	4.1	From 18 to 23 months
14.3	18.3	.	11.2	8.6	12.4	7.2	.	7.4	From 24 to 47 months
.	4.7	.	(3.7)	1.4	5.9	13.9	10.8	13.9	Less than 1 month
19.6	22.8	46.2	19.3	53.6	36.2	62.9	52.9	54.6	Less than 6 months
32.8	38.6	67.7	56.6	68.7	58.9	77.3	70.5	70.3	Less than 12 months
67.2	61.4	(32.2)	43.4	31.3	41.1	22.7	29.5	29.7	12 months and more
51.5	43.2	(19.3)	24.7	14.6	20.3	13.3	.	18.0	24 months and more
37.2	24.9	.	13.6	6.0	7.9	6.2	.	10.6	48 months and more
Males									
7.8	7.5	.	12.4	32.9	13.4	23.4	10.7	19.2	From 1 to 2 months
10.5	11.2	.	(9.3)	25.7	17.5	22.9	30.0	18.7	From 3 to 5 months
13.0	14.5	.	27.3	11.4	24.0	15.8	15.8	15.6	From 6 to 11 months
9.0	7.8	.	(6.3)	8.3	15.0	5.1	9.4	8.1	From 12 to 17 months
6.4	9.2	.	11.1	4.5	7.1	4.0	23.2	4.5	From 18 to 23 months
16.0	18.9	.	13.9	7.9	11.9	7.0	.	8.4	From 24 to 47 months
.	4.6	.	.	2.1	5.6	13.7	10.1	11.9	Less than 1 month
18.7	23.4	(38.3)	25.0	60.7	36.5	60.0	50.9	49.8	Less than 6 months
31.7	37.9	(61.3)	52.4	72.1	60.5	75.8	66.7	65.4	Less than 12 months
68.3	62.1	(38.5)	47.6	27.9	39.5	24.2	33.3	34.6	12 months and more
52.9	45.1	.	30.2	15.1	17.3	15.1	.	21.9	24 months and more
36.9	26.2	.	16.3	7.2	5.4	8.1	.	13.6	48 months and more
Females									
(8.1)	7.1	.	(5.2)	20.5	13.7	31.1	15.9	26.3	From 1 to 2 months
12.3	10.4	(23.2)	(5.6)	23.8	15.9	20.5	28.0	19.1	From 3 to 5 months
13.3	17.0	.	44.6	19.7	21.5	13.0	20.1	16.0	From 6 to 11 months
9.8	7.7	.	(4.7)	13.9	13.7	6.0	7.9	6.8	From 12 to 17 months
(6.3)	11.5	.	14.7	7.6	5.7	3.7	16.4	3.3	From 18 to 23 months
11.5	17.8	.	9.2	9.4	12.9	7.4	.	5.7	From 24 to 47 months
.	4.8	.	(4.0)	.	6.3	14.1	11.7	17.1	Less than 1 month
21.2	22.3	(52.4)	15.1	44.8	35.9	65.7	55.6	62.5	Less than 6 months
34.5	39.3	72.8	59.7	64.5	57.4	78.7	75.7	78.5	Less than 12 months
65.5	60.7	(27.1)	40.3	35.5	42.6	21.3	24.3	21.5	12 months and more
49.3	41.5	.	20.8	13.9	23.2	11.6	.	11.4	24 months and more
37.8	23.7	.	11.6	4.5	10.3	4.3	.	5.7	48 months and more

(1) These percentages were calculated using data from the NEWCRONOS table *u_ga_d*. Non responses to the variable DURATION OF SEARCH FOR EMPLOYMENT not considered.

(2) 1998.

(3) 1997.

(4) Greece 1998, Ireland 1997.

(5) Ireland 1997.

Table 58⁽¹⁾

Unemployment by age group and duration, as percent of the total unemployment

⁽¹⁾ Percentages of the Male and/or Female population unemployed. Percentages of the Male and/or Female population unemployed in a given age group⁽²⁾

	EU-15 ⁽⁵⁾	EUR-11 ⁽⁶⁾	B	DK	D	EL ⁽³⁾	E	F
Males and Females								
15-24 years*	24.5	23.3	24.5	30.2	11.3	35.3	28.6	22.1
Less than 6 months	47.0	43.2	41.3	83.8	47.5	25.8	41.2	63.8
6 to 11 months	21.2	21.8	22.1	10.4	25.6	22.7	26.1	16.0
12 months or more	31.9	34.9	36.6	(5.8)	26.9	51.5	32.6	20.2
25-49 years*	59.2	60.4	65.0	49.4	58.3	56.0	59.5	65.0
Less than 6 months	36.3	34.5	23.2	56.4	35.1	24.9	32.3	45.4
6 to 11 months	15.5	15.3	10.1	22.8	15.0	18.2	17.5	14.0
12 months or more	48.2	50.2	66.7	20.8	49.9	56.9	50.2	40.6
50-64 years*	16.1	16.1	10.5	20.3	30.3	8.4	11.8	12.9
Less than 6 months	27.5	25.0	13.9	42.7	23.3	24.4	28.4	27.3
6 to 11 months	13.0	12.9	(9.1)	16.1	12.7	19.6	13.0	12.6
12 months or more	59.5	62.1	77.0	41.1	64.0	55.9	58.6	60.0
15-64 years*	99.8	99.9	99.9	99.9	99.9	99.6	100.0	100.0
Less than 6 months	37.4	35.0	26.7	61.9	32.8	25.2	34.4	47.2
6 to 11 months	16.5	16.4	12.9	17.7	15.4	19.9	19.4	14.3
12 months or more	46.1	48.6	60.4	20.5	51.7	54.9	46.1	38.6
Males								
15-24 years*	25.0	23.9	27.5	31.3	12.3	34.5	29.5	24.1
Less than 6 months	49.5	45.8	39.4	88.3	49.5	30.8	47.1	65.7
6 to 11 months	20.9	21.0	23.5	.	24.5	29.2	24.9	15.3
12 months or more	29.6	33.1	37.1	.	26.0	40.0	28.0	19.0
25-49 years*	55.9	57.0	60.4	49.1	56.1	52.4	53.6	61.4
Less than 6 months	38.6	37.3	24.0	56.5	37.2	32.0	40.7	46.7
6 to 11 months	15.0	14.7	9.1	22.1	15.1	21.8	18.1	14.0
12 months or more	46.5	48.0	66.9	21.5	47.7	46.2	41.1	39.2
50-64 years*	18.9	19.0	12.0	19.4	31.5	12.4	16.8	14.5
Less than 6 months	28.1	25.8	(14.2)	(31.0)	24.9	28.5	30.0	26.8
6 to 11 months	12.5	12.6	.	(25.5)	12.6	21.1	12.7	12.1
12 months or more	59.4	61.6	76.7	43.5	62.4	50.4	57.3	61.2
15-64 years*	99.8	99.9	99.9	99.9	99.9	99.4	99.9	99.9
Less than 6 months	39.3	37.1	27.1	61.5	34.7	31.1	40.8	48.4
6 to 11 months	16.0	15.8	13.1	17.5	15.4	24.3	19.2	14.0
12 months or more	44.8	47.1	59.9	20.9	49.8	44.6	40.0	37.6
Females								
15-24 years*	24.0	22.9	21.7	29.2	10.1	35.7	28.1	20.4
Less than 6 months	44.3	40.7	43.7	79.5	44.6	22.6	36.8	61.7
6 to 11 months	21.5	22.6	20.3	(15.0)	27.2	18.7	27.0	16.8
12 months or more	34.2	36.7	36.0	.	28.2	58.7	36.2	21.4
25-49 years*	62.5	63.6	69.4	49.6	60.9	58.3	63.8	68.1
Less than 6 months	34.3	32.2	22.5	56.3	32.9	20.8	27.2	44.4
6 to 11 months	16.1	15.9	10.9	23.4	14.8	16.1	17.1	14.0
12 months or more	49.6	52.0	66.6	20.3	52.3	63.1	55.7	41.6
50-64 years*	13.3	13.5	8.9	21.1	28.9	5.7	8.1	11.4
Less than 6 months	26.6	23.9	.	52.1	21.2	(18.7)	26.1	28.0
6 to 11 months	13.7	13.4	.	.	12.8	(17.6)	13.4	13.3
12 months or more	59.7	62.6	77.4	39.2	66.0	63.7	60.5	58.7
15-64 years*	99.9	99.9	100.0	99.9	99.9	99.8	100.0	100.0
Less than 6 months	35.6	32.9	26.3	62.2	30.6	21.3	29.8	46.1
6 to 11 months	17.0	17.0	12.8	17.8	15.4	17.1	19.6	14.5
12 months or more	47.3	50.0	60.9	20.0	54.0	61.6	50.6	39.4

⁽¹⁾ These percentages were calculated using data from the NEWCRONOS table *u_ga_d*.

⁽²⁾ Non responses to the variable DURATION OF SEARCH FOR EMPLOYMENT not considered.

⁽³⁾ 1998.

⁽⁴⁾ 1997.

⁽⁵⁾ Greece 1998, Ireland 1997.

⁽⁶⁾ Ireland 1997.

(1) Table 58

Unemployment by age group and duration, as percent of the total unemployment

 *Percentages of the Male and/or Female population unemployed. Percentages of the Male and/or Female population unemployed in a given age group⁽²⁾

IRL ⁽⁴⁾	I	L	NL	A	P	FIN	S	UK	
Males and Females									
29.6	32.0	(25.8)	32.7	17.5	29.4	37.2	21.1	30.8	15-24 years*
37.1	21.7	.	17.4	69.7	46.3	87.8	72.7	68.0	Less than 6 months
20.2	19.8	.	62.7	15.2	29.5	8.2	17.6	18.3	6 to 11 months
42.7	58.6	.	19.9	15.1	24.3	(3.9)	.	13.7	12 months or more
58.5	60.4	65.5	55.2	65.0	54.7	46.8	56.4	52.3	25-49 years*
15.8	23.0	(44.2)	21.4	53.7	34.7	52.9	50.7	50.6	Less than 6 months
11.7	14.2	(21.0)	31.1	15.0	20.5	19.0	19.7	15.3	6 to 11 months
72.5	62.8	(34.8)	47.6	31.3	44.8	28.2	29.6	34.1	12 months or more
11.5	7.2	.	12.1	17.6	15.7	15.9	22.3	16.3	50-64 years*
.	25.1	.	(13.5)	37.3	23.4	34.9	39.7	41.6	Less than 6 months
.	12.8	.	(19.8)	15.4	18.1	14.9	12.5	12.4	6 to 11 months
76.2	62.1	.	66.7	47.3	58.5	50.2	47.8	46.0	12 months or more
99.6	99.7	98.5	100.0	100.0	99.8	100.0	99.8	99.4	15-64 years*
19.7	22.8	46.9	19.3	53.6	36.3	62.9	52.9	54.5	Less than 6 months
13.2	15.9	(21.8)	37.3	15.1	22.7	14.4	17.7	15.7	6 to 11 months
67.1	61.4	(31.3)	43.4	31.3	41.0	22.7	29.4	29.8	12 months or more
Males									
28.0	33.1	(28.3)	35.0	15.6	27.0	37.6	20.1	30.5	15-24 years*
36.5	22.1	.	(26.3)	78.8	41.3	85.3	68.1	64.9	Less than 6 months
(20.3)	18.9	.	56.7	.	39.7	9.5	.	19.6	6 to 11 months
43.2	59.0	.	(17.1)	.	19.1	(5.2)	.	15.5	12 months or more
57.8	57.3	(58.8)	53.5	63.2	52.0	45.3	55.8	50.3	25-49 years*
15.2	24.1	.	27.1	62.4	39.0	49.3	49.1	44.6	Less than 6 months
11.6	12.4	.	(15.9)	11.5	20.0	20.3	16.0	14.9	6 to 11 months
73.2	63.5	.	57.0	26.1	41.1	30.4	34.9	40.5	12 months or more
13.9	9.4	.	11.5	21.1	20.7	17.0	23.8	18.3	50-64 years*
.	23.1	.	.	42.0	25.0	32.6	41.1	38.6	Less than 6 months
.	12.2	.	.	12.2	(13.9)	(17.5)	.	11.0	6 to 11 months
76.5	64.7	.	(70.5)	45.8	61.2	49.9	48.0	50.4	12 months or more
99.7	99.7	96.7	100.0	100.0	99.7	100.0	99.7	99.2	15-64 years*
18.8	23.4	(39.8)	25.0	60.7	36.7	60.0	51.0	49.7	Less than 6 months
13.0	14.5	.	27.3	11.4	24.0	15.8	15.9	15.6	6 to 11 months
68.2	62.1	(36.5)	47.7	27.9	39.3	24.2	33.1	34.7	12 months or more
Females									
32.0	31.1	(23.8)	31.0	19.8	31.7	36.8	22.4	31.2	15-24 years*
(37.9)	21.2	.	.	60.7	50.5	90.3	78.4	72.9	Less than 6 months
.	20.6	.	68.2	20.4	20.9	(7.0)	.	16.2	6 to 11 months
(42.0)	58.2	.	(22.4)	18.8	28.6	.	.	10.9	12 months or more
59.7	63.2	71.0	56.4	67.1	57.4	48.3	57.2	55.6	25-49 years*
16.8	22.2	(47.1)	17.5	43.5	31.0	56.0	52.8	59.7	Less than 6 months
(11.8)	15.6	.	41.3	19.1	21.0	17.8	24.6	15.8	6 to 11 months
71.5	62.2	(32.3)	41.2	37.4	48.0	26.2	22.6	24.4	12 months or more
7.7	5.4	.	12.6	13.1	10.8	14.9	20.1	12.9	50-64 years*
.	28.1	.	.	27.8	(20.4)	37.4	37.4	48.7	Less than 6 months
.	13.7	.	(22.2)	21.8	(26.1)	(12.1)	.	15.8	6 to 11 months
.	58.2	.	64.1	50.4	53.6	50.5	47.4	35.5	12 months or more
99.4	99.6	100.0	100.0	100.0	99.9	100.0	99.8	99.7	15-64 years*
21.2	22.2	(52.5)	15.1	44.8	35.9	65.7	55.5	62.4	Less than 6 months
13.4	17.0	.	44.6	19.7	21.5	13.0	20.2	15.9	6 to 11 months
65.4	60.7	(27.2)	40.3	35.5	42.6	21.3	24.3	21.6	12 months or more

 (1) These percentages were calculated using data from the NEWCRONOS table *u_ga_d*.

(2) Non responses to the variable DURATION OF SEARCH FOR EMPLOYMENT not considered.

(3) 1998.

(4) 1997.

(5) Greece 1998, Ireland 1997.

(6) Ireland 1997.

Table 59⁽¹⁾

Unemployed by age group and type of employment sought

⁽²⁾ Percentages of the Male and/or Female population unemployed, Percentages of the Male and/or Female population unemployed in a given age group⁽²⁾

	EU-15 ⁽⁴⁾	EUR-11	B	DK	D	EL ⁽³⁾	E	F
Males and Females								
15-24 years	24.5	23.3	24.5	30.2	11.3	35.3	28.6	22.1
Self-employment	(1.8)	.	(1.2)
Only full-time paid Job	27.4	28.8	15.0	28.9	78.7	36.3	10.8	32.1
Only part-time paid Job	9.0	6.5	5.2	33.0	5.7	2.7	4.6	4.3
Full-time or part-time paid Job	44.8	44.0	61.8	32.7	15.1	54.7	32.7	62.4
25-49 years	59.2	60.4	65.0	49.4	58.3	56.0	59.5	65.0
Self-employment	2.0	1.7	2.2	.	.	2.4	0.3	2.9
Only full-time paid Job	34.6	35.2	19.4	40.5	67.7	43.5	11.7	34.1
Only part-time paid Job	8.9	8.6	6.0	10.0	10.0	2.0	3.7	9.0
Full-time or part-time paid Job	39.8	39.5	56.0	45.7	21.7	48.9	33.4	54.0
50-64 years	16.1	16.2	10.5	20.3	30.3	8.4	11.8	12.9
Self-employment	.	.	(6.4)	.	.	(6.3)	.	2.4
Only full-time paid Job	40.6	43.4	24.7	40.6	64.4	31.6	9.8	33.6
Only part-time paid Job	9.4	8.8	.	(9.3)	9.7	.	2.9	8.5
Full-time or part-time paid Job	36.2	35.1	45.3	48.6	25.0	53.3	31.0	55.5
15-64 years	99.8	99.9	99.9	99.9	99.9	99.6	100.0	100.0
Self-employment	1.7	1.5	2.7	(2.7)	0.3	2.5	0.3	2.5
Only full-time paid Job	33.8	35.0	18.9	36.9	67.9	40.0	11.2	33.6
Only part-time paid Job	9.0	8.1	5.7	16.9	9.4	2.5	3.9	7.9
Full-time or part-time paid Job	40.5	39.9	56.3	42.3	22.0	51.3	32.9	56.0
Males								
15-24 years	25.0	23.8	27.5	31.3	12.3	34.5	29.5	24.1
Self-employment	(1.8)
Only full-time paid Job	31.9	34.6	18.7	33.8	85.4	33.2	13.0	38.6
Only part-time paid Job	6.9	4.6	.	31.8	.	.	3.8	3.5
Full-time or part-time paid Job	42.4	40.4	55.7	28.5	11.7	55.6	31.5	56.2
25-49 years	55.9	57.0	60.4	49.1	56.1	52.4	53.6	61.4
Self-employment	2.9	2.6	(2.4)	.	.	(4.0)	(0.6)	4.5
Only full-time paid Job	46.4	48.3	27.7	49.3	83.1	47.7	16.3	47.5
Only part-time paid Job	1.9	1.8	.	.	1.3	.	(0.7)	2.5
Full-time or part-time paid Job	34.2	32.4	50.4	40.8	14.7	45.1	30.6	45.4
50-64 years	18.9	19.0	12.0	19.4	31.5	12.4	16.8	14.5
Self-employment	(3.5)
Only full-time paid Job	47.7	51.8	34.7	50.3	75.8	35.0	13.6	41.5
Only part-time paid Job	.	3.0	.	.	3.4	.	.	(3.0)
Full-time or part-time paid Job	32.7	30.5	41.6	47.8	19.7	53.7	27.8	52.0
15-64 years	99.8	99.9	99.9	99.9	99.9	99.4	99.9	99.9
Self-employment	2.3	2.0	3.0	.	.	4.0	(0.4)	3.7
Only full-time paid Job	43.1	45.7	26.1	44.4	81.1	41.1	14.9	44.5
Only part-time paid Job	3.4	2.7	(1.4)	13.5	2.1	(1.6)	1.5	2.8
Full-time or part-time paid Job	36.0	33.9	50.8	38.1	16.0	49.8	30.4	48.9
Females								
15-24 years	24.0	22.8	21.7	29.2	10.1	35.7	28.1	20.4
Self-employment
Only full-time paid Job	22.7	23.1	(10.3)	24.1	68.7	38.2	9.1	25.2
Only part-time paid Job	11.0	8.3	(7.6)	34.2	10.4	.	5.3	5.2
Full-time or part-time paid Job	47.2	47.5	69.3	36.8	20.0	54.2	33.7	69.0
25-49 years	62.5	63.5	69.4	49.6	60.9	58.3	63.8	68.1
Self-employment	1.2	1.1	(2.1)	.	.	(1.5)	.	1.6
Only full-time paid Job	24.3	24.3	12.4	33.3	50.7	41.1	8.9	23.4
Only part-time paid Job	15.0	14.2	10.7	13.2	19.5	2.9	5.5	14.2
Full-time or part-time paid Job	44.8	45.4	60.7	49.6	29.3	51.1	35.1	60.8
50-64 years	13.4	13.5	8.9	21.1	28.9	5.7	8.1	11.4
Self-employment
Only full-time paid Job	30.5	32.3	.	33.1	49.4	(26.7)	(4.1)	24.7
Only part-time paid Job	17.6	16.4	.	(16.0)	17.9	.	6.7	14.6
Full-time or part-time paid Job	41.0	41.2	50.2	49.2	31.8	52.6	35.7	59.5
15-64 years	99.9	99.9	100.0	99.9	99.9	99.8	100.0	100.0
Self-employment	1.1	0.9	(2.3)	.	.	1.6	(0.2)	1.3
Only full-time paid Job	24.8	25.1	11.9	30.6	52.0	39.2	8.6	23.9
Only part-time paid Job	14.4	13.2	9.8	19.9	18.2	3.1	5.5	12.4
Full-time or part-time paid Job	44.9	45.3	61.6	45.8	29.2	52.3	34.7	62.3

⁽¹⁾ These percentages were calculated using data from the NEWCRONOS table u_ga_tes.

⁽²⁾ Non responses to the variable TYPE OF EMPLOYMENT SOUGHT not considered.

⁽³⁾ 1998.

⁽⁴⁾ Greece 1998.

(1) Table 59

Unemployed by age group and type of employment sought

 *Percentages of the Male and/or Female population unemployed. Percentages of the Male and/or Female population unemployed in a given age group⁽²⁾

IRL	I	L	NL	A	P	FIN	S	UK	
Males and Females									
29.1	32.0	(25.8)	32.7	17.5	29.4	37.2	21.1	30.8	15-24 years
	1.4				(3.9)				Self-employment
(13.5)	24.6		34.1	67.8	8.4	8.9	52.6	12.1	Only full-time paid Job
	3.2		65.3	12.2		12.6	15.0	23.6	Only part-time paid Job
78.0	46.2			19.9	87.7	77.2	31.8	48.9	Full-time or part-time paid Job
56.9	60.4	65.5	55.2	65.0	54.7	46.8	56.4	52.3	25-49 years
(4.9)	2.2		7.0	3.4	5.8	(1.8)		4.5	Self-employment
11.6	23.2	(30.1)	40.7	52.7	10.5	20.9	73.2	19.0	Only full-time paid Job
11.2	7.7	(20.0)	52.3	18.2			6.6	14.0	Only part-time paid Job
72.3	43.8	(41.4)		25.7	83.6	75.8	19.6	43.6	Full-time or part-time paid Job
13.8	7.2		12.1	17.6	15.7	15.9	22.3	16.3	50-64 years
	(2.6)							4.4	Self-employment
	19.1		30.6	59.4	(8.5)	25.6	64.3	14.1	Only full-time paid Job
	6.8		68.4	9.6			13.2	13.2	Only part-time paid Job
71.1	39.5			26.8	85.6	68.2	20.6	44.4	Full-time or part-time paid Job
99.8	99.7	98.5	100.0	100.0	99.8	100.0	99.8	99.4	15-64 years
(3.6)	2.0		4.1	3.0	5.3	1.5		3.5	Self-employment
12.0	23.4	(33.8)	37.3	56.6	9.6	17.2	66.7	16.0	Only full-time paid Job
10.6	6.2	(16.0)	58.5	15.6		5.6	9.9	16.8	Only part-time paid Job
73.8	44.3	40.0		24.9	85.1	75.1	22.5	45.3	Full-time or part-time paid Job
Males									
26.2	33.1	(28.3)	35.0	15.6	27.0	37.6	20.1	30.5	15-24 years
	1.9								Self-employment
	25.9		44.1	80.0	(8.9)	12.4	53.5	15.8	Only full-time paid Job
	(1.7)		55.9			9.5		16.9	Only part-time paid Job
79.2	42.4			15.4	88.1	77.0	32.2	51.5	Full-time or part-time paid Job
57.5	57.3	(58.8)	53.5	63.2	52.0	45.3	55.8	50.3	25-49 years
	3.4		(9.7)	4.4	7.9			5.4	Self-employment
15.1	29.7		70.1	74.5	10.3	28.3	80.0	26.8	Only full-time paid Job
	1.5		20.1					2.0	Only part-time paid Job
78.8	34.8			18.7	81.8	69.1	16.6	47.8	Full-time or part-time paid Job
16.1	9.4		11.5	21.1	20.7	17.0	23.8	18.3	50-64 years
	(3.2)							5.4	Self-employment
	23.4		(64.6)	69.2		28.8	75.3	17.5	Only full-time paid Job
			(32.8)					6.0	Only part-time paid Job
79.9	30.7			21.8	85.0	65.4		46.6	Full-time or part-time paid Job
99.8	99.7	96.7	100.0	100.0	99.7	100.0	99.7	99.2	15-64 years
	2.9		(5.5)	3.5	6.2			4.2	Self-employment
14.7	27.9	(46.3)	60.4	74.2	9.7	22.4	73.4	21.7	Only full-time paid Job
	1.6		34.1	3.4		4.1	6.0	7.3	Only part-time paid Job
79.1	36.9	(36.4)		18.9	84.1	71.5	19.6	48.7	Full-time or part-time paid Job
Females									
33.8	31.1	(23.8)	31.0	19.8	31.7	36.8	22.4	31.2	15-24 years
	(0.8)								Self-employment
	23.5		25.8	55.9	(8.0)	(5.4)	51.4	6.2	Only full-time paid Job
	4.6		73.2	19.7		15.6		34.3	Only part-time paid Job
76.5	49.7			24.4	87.3	77.4	31.4	44.9	Full-time or part-time paid Job
55.9	63.2	71.0	56.4	67.1	57.4	48.3	57.2	55.6	25-49 years
	1.3		(5.0)		(4.0)			3.2	Self-employment
	18.0		20.1	27.1	10.7	14.2	64.4	7.2	Only full-time paid Job
28.0	12.5	(32.5)	74.8	36.7				31.9	Only part-time paid Job
61.8	50.8	(44.7)		33.8	85.3	81.8	23.5	37.2	Full-time or part-time paid Job
(10.0)	5.4		12.6	13.1	10.8	14.9	20.1	12.9	50-64 years
									Self-employment
	12.5			39.9		22.2	46.5		Only full-time paid Job
	14.2		92.0					30.0	Only part-time paid Job
	53.2			36.9	86.9	71.2		39.1	Full-time or part-time paid Job
99.7	99.6	100.0	100.0	100.0	99.9	100.0	99.8	99.7	15-64 years
	1.2		(3.1)		4.4			2.4	Self-employment
(7.7)	19.5	(23.9)	20.4	34.5	9.5	12.1	57.8	6.7	Only full-time paid Job
23.4	10.1	(27.9)	76.5	30.9		7.1	15.2	32.4	Only part-time paid Job
65.5	50.6	(42.8)		32.4	86.1	78.6	26.4	39.8	Full-time or part-time paid Job

 (1) These percentages were calculated using data from the NEWCRONOS table *u_gc_tes*.

(2) Non responses to the variable TYPE OF EMPLOYMENT SOUGHT not considered.

(3) 1998.

(4) Greece 1998.

Table 60⁽¹⁾

Previous occupation of the unemployed

Percentages of the Male and/or Female population in unemployment having already had a job

	EU-15	EUR-11	B	DK	D	EL ⁽²⁾	E	F
Males and Females								
Legislators and managers (1)	-	-	5.0	3.5	3.2	4.9	2.4	-
Professionals (2)	-	-	6.6	(3.2)	5.9	4.7	4.7	-
Technicians (3)	-	-	7.7	9.2	13.7	7.3	5.9	-
Clerks (4)	-	-	13.1	12.1	11.0	11.6	10.0	-
Services and sales workers (5)	-	-	16.8	21.2	12.7	20.9	20.2	-
Agriculture/ fishery workers (6)	-	-	2.6	.	3.0	2.1	2.2	-
Craft/related trades workers (7)	-	-	17.8	9.5	24.7	23.0	14.1	-
Plant and machine operators (8)	-	-	11.9	9.7	10.7	13.2	7.3	-
Elementary occupations (9)	-	-	17.6	29.5	14.8	11.5	33.2	-
Armed forces (0)	-	-	-
Males								
Legislators and managers (1)	-	-	6.6	(4.1)	4.1	7.0	2.6	-
Professionals (2)	-	-	4.0	.	6.3	(2.3)	3.1	-
Technicians (3)	-	-	6.8	(6.9)	9.0	7.9	5.9	-
Clerks (4)	-	-	7.5	(5.9)	5.5	5.6	5.1	-
Services and sales workers (5)	-	-	6.8	12.9	4.8	14.3	12.3	-
Agriculture/ fishery workers (6)	-	-	3.6	.	3.1	(3.1)	3.3	-
Craft/related trades workers (7)	-	-	29.0	17.2	37.5	30.6	24.2	-
Plant and machine operators (8)	-	-	17.1	11.8	14.3	18.2	9.9	-
Elementary occupations (9)	-	-	17.4	35.5	15.1	9.8	33.5	-
Armed forces (0)	-	-	-
Females								
Legislators and managers (1)	-	-	(3.2)	.	2.1	(2.9)	2.1	-
Professionals (2)	-	-	9.5	.	5.4	7.0	6.2	-
Technicians (3)	-	-	8.7	11.2	19.8	6.8	5.9	-
Clerks (4)	-	-	19.4	17.5	18.1	17.5	14.3	-
Services and sales workers (5)	-	-	27.8	28.5	22.8	27.2	27.4	-
Agriculture/ fishery workers (6)	-	-	.	.	3.0	.	1.2	-
Craft/related trades workers (7)	-	-	5.6	.	8.2	15.8	5.0	-
Plant and machine operators (8)	-	-	6.3	7.8	6.0	8.4	5.0	-
Elementary occupations (9)	-	-	17.9	24.2	14.6	13.2	33.0	-
Armed forces (0)	-	-	-

⁽¹⁾ These percentages were calculated using data from the NEWCRONOS table *u_p_1s*. Non responses to the variable OCCUPATION OF LAST JOB not considered.

⁽²⁾ 1998.

⁽³⁾ 1997.

Table 60

Previous occupation of the unemployed

Percentages of the Male and/or Female population in unemployment having already had a job

IRL ⁽³⁾	I	L	NL	A	P	FIN	S	UK	
Males and Females									
(3.6)	(0.7)	.	—	2.6	2.7	(1.8)	—	7.9	Legislators and managers (1)
5.6	3.4	.	—	3.6	3.9	8.0	—	7.0	Professionals (2)
(3.0)	8.1	.	—	9.5	4.7	11.8	—	6.0	Technicians (3)
9.8	8.3	.	—	14.3	13.9	9.7	—	13.0	Clerks (4)
23.7	21.5	(25.6)	—	17.4	18.8	17.0	—	17.6	Services and sales workers (5)
.	2.4	.	—	.	.	6.9	—	1.3	Agriculture/ fishery workers (6)
20.9	20.9	.	—	23.5	23.6	16.5	—	14.9	Craft/related trades workers (7)
10.2	9.6	.	—	12.0	10.4	8.0	—	12.4	Plant and machine operators (8)
22.3	24.9	.	—	16.1	20.6	20.3	—	19.6	Elementary occupations (9)
.	.	.	—	.	.	.	—	.	Armed forces (0)
Males									
(4.1)	(0.9)	.	—	.	(4.3)	(2.4)	—	8.2	Legislators and managers (1)
(4.4)	1.9	.	—	.	(3.9)	5.5	—	6.8	Professionals (2)
.	7.6	.	—	9.5	5.4	8.4	—	5.7	Technicians (3)
(4.5)	5.0	.	—	7.2	11.4	4.5	—	8.9	Clerks (4)
13.9	14.0	.	—	6.9	10.1	7.2	—	10.4	Services and sales workers (5)
.	2.7	.	—	.	.	9.4	—	1.9	Agriculture/ fishery workers (6)
25.5	31.5	.	—	38.3	33.6	29.7	—	20.7	Craft/related trades workers (7)
13.7	12.3	.	—	16.2	13.0	13.1	—	16.5	Plant and machine operators (8)
30.0	23.5	.	—	15.4	16.4	19.8	—	20.5	Elementary occupations (9)
.	.	.	—	.	.	.	—	.	Armed forces (0)
Females									
.	.	.	—	.	.	.	—	7.3	Legislators and managers (1)
(7.7)	5.0	.	—	.	(3.9)	10.3	—	7.4	Professionals (2)
.	8.6	.	—	9.5	(3.9)	15.0	—	6.5	Technicians (3)
18.8	11.7	.	—	22.4	16.6	14.6	—	20.5	Clerks (4)
40.8	29.5	.	—	29.3	28.3	26.3	—	31.0	Services and sales workers (5)
.	2.0	.	—	.	.	4.6	—	.	Agriculture/ fishery workers (6)
13.1	9.7	.	—	6.5	12.7	4.1	—	4.3	Craft/related trades workers (7)
.	6.6	.	—	7.2	7.5	(3.2)	—	4.9	Plant and machine operators (8)
(9.0)	26.4	.	—	16.9	25.2	20.7	—	17.9	Elementary occupations (9)
.	.	.	—	.	.	.	—	.	Armed forces (0)

⁽¹⁾ These percentages were calculated using data from the NEWCRONOS table *u_p_is*. Non responses to the variable OCCUPATION OF LAST JOB not considered.

⁽²⁾ 1998.

⁽³⁾ 1997.

Table 61⁽¹⁾

Methods used for seeking work

Percentages of the Male and/or Female population in unemployment

	EU-15 ⁽²⁾	EUR-11	B	DK	D	EL ⁽²⁾	E	F
Males and Females								
Contact publ. employment office	74.5	76.9	64.7	53.0	96.2	11.2	84.8	94.5
Contact priv. employment office	15.2	15.1	27.4	5.3	17.9	.	8.1	29.5
Apply to employers directly	33.2	30.3	29.8	43.3	10.2	39.0	36.9	53.3
Ask friends, relatives, trade union	43.2	42.2	29.9	13.3	25.0	25.5	53.0	65.4
Insert/answer advertisements	29.5	26.5	20.5	36.5	44.9	3.1	9.8	36.9
Study advertisements	41.9	37.8	46.2	27.4	35.0	17.3	16.4	68.3
Took test, interview, examination	11.5	13.8	8.9	.	6.9	.	2.5	20.8
Look for land, premises, equipm.	0.4	0.4	.
Look for permits, licenses, financ.	0.9	0.8	.	.	.	(0.6)	0.6	2.2
Other method	9.4	9.7	3.4	16.2	0.4	2.8	5.5	9.5
Males								
Contact publ. employment office	77.0	78.2	67.5	57.6	97.4	9.9	86.2	95.4
Contact priv. employment office	17.7	17.1	30.0	(5.6)	18.2	.	7.7	36.7
Apply to employers directly	35.1	31.2	30.7	50.7	10.3	45.2	43.0	55.5
Ask friends, relatives, trade union	44.6	42.8	28.7	15.3	24.8	25.1	53.3	67.4
Insert/answer advertisements	31.4	27.3	21.0	31.5	44.2	2.6	8.7	37.1
Study advertisements	42.7	37.0	42.4	27.7	34.1	12.5	14.2	68.0
Took test, interview, examination	11.6	14.5	10.5	.	6.9	.	2.6	21.2
Look for land, premises, equipm.	0.6	.
Look for permits, licenses, financ.	1.3	1.2	0.8	3.3
Other method	8.6	8.7	4.5	11.7	.	2.9	4.4	9.2
Females								
Contact publ. employment office	71.9	75.6	61.9	49.1	94.7	12.0	83.7	93.8
Contact priv. employment office	12.8	13.2	24.8	(5.0)	17.6	.	8.3	22.9
Apply to employers directly	31.3	29.5	29.0	36.9	10.2	34.9	32.5	51.3
Ask friends, relatives, trade union	41.7	41.7	31.2	11.6	25.2	25.8	52.7	63.7
Insert/answer advertisements	27.6	25.9	20.0	40.8	45.7	3.4	10.7	36.8
Study advertisements	41.2	38.6	50.0	27.1	36.1	20.4	18.0	68.6
Took test, interview, examination	11.3	13.2	7.2	.	7.0	.	2.5	20.4
Look for land, premises, equipm.	(0.2)	.
Look for permits, licenses, financ.	.	0.5	0.4	1.3
Other method	10.1	10.6	(2.4)	20.2	.	2.8	6.4	9.8

⁽¹⁾ These percentages were calculated using data from the NEWCRONOS table *u_m_sw*.⁽²⁾ 1998.⁽³⁾ Greece 1998.

(1) Table 61

Methods used for seeking work

Percentages of the Male and/or Female population in unemployment

IRL	I	L	NL	A	P	FIN	S	UK	
Males and Females									
49.8	35.3	63.8	37.6	74.5	49.8	65.9	88.0	73.3	Contact publ. employment office
19.9	4.0	(12.6)	8.7	.	2.8	4.8	.	24.1	Contact priv. employment office
70.5	21.1	51.2	8.9	11.8	35.1	59.4	13.0	56.5	Apply to employers directly
73.7	33.8	51.0	.	12.8	42.1	41.6	5.8	64.9	Ask friends, relatives, trade union
28.8	13.4	(26.0)	8.7	4.6	20.7	19.9	11.4	62.2	Insert/answer advertisements
89.8	28.9	74.9	.	8.5	8.4	71.5	2.9	88.7	Study advertisements
28.8	28.4	.	.	.	5.9	17.1	.	.	Took test, interview, examination
.	0.4	1.8	Look for land, premises, equipm.
.	0.7	1.7	Look for permits, licenses, financ.
.	15.0	(25.2)	35.1	.	100.0	28.9	2.8	9.1	Other method
Males									
52.0	33.4	(68.7)	44.1	77.6	46.3	64.0	88.2	81.4	Contact publ. employment office
19.6	4.0	.	(8.5)	.	(2.8)	4.2	.	28.0	Contact priv. employment office
71.3	20.3	(61.9)	(8.7)	9.2	39.1	64.1	13.7	59.0	Apply to employers directly
74.9	37.8	(51.3)	.	12.2	44.9	44.0	7.3	67.2	Ask friends, relatives, trade union
28.6	13.4	(28.7)	9.4	4.2	20.6	18.3	10.6	64.1	Insert/answer advertisements
89.4	26.6	79.1	.	5.4	9.0	69.2	.	88.5	Study advertisements
27.7	31.4	.	.	.	4.1	16.3	.	.	Took test, interview, examination
.	0.7	2.3	Look for land, premises, equipm.
.	1.1	2.2	Look for permits, licenses, financ.
.	13.4	(26.6)	28.2	.	100.0	28.5	.	9.6	Other method
Females									
46.4	37.0	(59.8)	32.8	70.6	53.2	67.8	87.6	59.6	Contact publ. employment office
20.3	3.9	.	8.9	.	(2.8)	5.4	.	17.3	Contact priv. employment office
69.3	21.8	(42.4)	9.0	15.0	31.3	54.9	12.2	52.3	Apply to employers directly
71.7	30.3	(50.8)	.	13.5	39.4	39.3	.	60.9	Ask friends, relatives, trade union
29.1	13.4	(23.7)	8.2	5.0	20.8	21.3	12.4	59.0	Insert/answer advertisements
90.5	30.8	71.4	.	12.4	7.7	73.6	.	89.0	Study advertisements
30.6	25.7	.	.	.	7.8	17.8	.	.	Took test, interview, examination
.	Look for land, premises, equipm.
.	(0.4)	Look for permits, licenses, financ.
.	16.4	(24.1)	40.3	.	100.0	29.4	.	8.3	Other method

 (1) These percentages were calculated using data from the NEWCRONOS table *u_m_sw*.

(2) 1998.

(3) Greece 1998.

Table 62

Main characteristics of unemployment by region

REGION	ALL UNEMPLOY- MENT (Thousands)	UNEMPLOY- MENT AGE 15-24 (Rate)	UNEMPLOY- MENT AGE 25-64 (Rate)	UNEMPLOY- MENT AGE 15-64 (Rate)	UNEMPLOY- MENT NATIONALS (Rate)	UNEMPLOY- MENT EU- NATIONALS (Rate)
BELGIQUE-BELGIE	378	22.6	7.3	8.7	7.6	13.3
Bruxelles-Cap-BrusselsHf.gewest	64	37.0	14.1	16.0	13.8	13.2
Antwerpen	45	18.2	5.4	6.5	5.3	.
Limburg (B)	22	15.9	5.5	6.6	6.0	.
Oost-Vlaanderen	40	16.7	5.4	6.6	5.8	.
Vlaams Brabant	17	14.7	2.8	3.7	3.8	.
West-Vlaanderen	20	11.4	3.3	4.1	3.9	.
Brabant Wallon	12	(23.9)	6.4	8.0	7.7	.
Hainaut	80	37.0	14.1	16.2	14.5	22.4
Liège	51	31.7	9.9	12.1	11.0	14.7
Luxemburg (B)	7	.	5.0	6.9	6.3	.
Namur	18	34.5	7.8	10.1	9.8	.
DANMARK	147	10.0	4.3	5.2	5.0	.
DEUTSCHLAND	3 506	8.9	8.9	8.9	8.2	8.8
Stuttgart	102	4.2	5.5	5.3	4.1	9.0
Karlsruhe	79	.	6.4	6.3	4.8	.
Freiburg	54	.	5.3	5.4	4.8	.
Tübingen	40	.	4.7	4.8	3.9	.
Oberbayern	85	4.9	4.0	4.1	3.4	.
Niederbayern	29	.	5.2	5.0	4.4	.
Oberplatz	24	.	4.5	4.6	4.2	.
Oberfranken	35	.	6.2	6.4	5.6	.
Mittelfranken	55	.	6.5	6.7	5.3	.
Unterfranken	41	.	5.8	6.2	5.5	.
Schwaben	40	.	4.6	4.7	3.6	.
Berlin-West, Stadt	161	21.8	15.3	15.9	13.4	.
Berlin-Ost, Stadt	101	11.0	15.0	14.5	13.8	.
Brandenburg	215	13.9	16.1	15.8	15.7	.
Bremen	36	.	11.6	11.6	9.9	.
Hamburg	74	10.0	8.5	8.6	7.5	.
Darmstadt	127	8.6	6.8	7.0	5.3	9.5
Gießen	36	.	7.2	7.6	6.3	.
Kassel	49	.	8.5	8.5	7.3	.
Mecklenburg-Vorpommern	168	11.0	19.4	18.2	18.1	.
Braunschweig	68	12.0	8.5	8.9	7.9	.
Hannover	80	.	8.2	8.1	7.1	.
Lüneburg	50	.	6.3	6.5	6.0	.
Weser-Ems	70	7.8	6.2	6.4	5.8	.
Düsseldorf	183	11.0	7.4	7.8	6.5	9.1
Köln	134	7.7	6.8	6.9	5.7	.
Münster	87	11.3	7.1	7.6	6.4	.
Detmold	60	.	6.4	6.4	5.6	.
Amsberg	141	10.5	8.1	8.4	7.0	.
Koblenz	41	10.4	5.4	6.0	5.7	.
Trier	13	.	5.9	5.7	4.9	.
Rheinhessen-Pfalz	59	.	6.3	6.2	5.9	.
Saarland	34	.	7.3	7.3	6.7	.
Sachsen	368	10.9	16.9	16.1	15.8	.
Dessau	60	.	22.5	21.0	20.8	.
Halle	98	.	23.4	22.2	22.0	.
Magdeburg	124	12.9	20.8	19.8	19.6	.
Schleswig-Holstein	102	10.1	7.5	7.8	7.1	.
Thüringen	185	8.3	15.4	14.6	14.4	.
ELLADA ⁽¹⁾	478	29.7	8.2	11.0	10.7	.
Anatoliki Makedonia, Thraki	22	16.0	8.0	9.1	8.8	.
Kentriki Makedonia	77	29.6	7.6	10.5	10.2	.
Dytiki Makedonia	13	37.2	7.9	11.5	11.2	.
Thessalia	34	34.7	7.9	11.1	10.8	.
Ipeiros	16	48.3	9.3	14.1	13.3	.
Ionia Nisia	(3)	.	.	(4.1)	(3.8)	.
Dytiki Ellada	29	34.7	7.6	11.3	10.8	.
Stereia Ellada	27	40.4	8.7	13.4	12.8	.

⁽¹⁾ 1998.

Table 62

Main characteristics of unemployment by region

UNEMPLOY- MENT NON-EU- NATIONALS (Rate)	UNEMPLOY- MENT < 6 MONTHS (% all Unemp.)	UNEMPLOY- MENT 6 - 11 MONTHS (% all Unemp.)	UNEMPLOY- MENT 12+ MONTHS (% all Unemp.)	UNEMPLOYM. (AGED 15-24) 6+ MONTHS (% young Unemp.)	SEEK FIRST JOB (% all Unemp.)	REGION
35.7	26.4	13.0	60.4	59.2	20.9	BELGIQUE-BELGIE
31.7	17.7	12.4	69.1	74.1	25.3	Bruxelles-Cap-BrusselsHf.gewest
39.5	27.3	14.4	57.1	67.0	15.7	Antwerpen
.	35.4	(13.4)	48.9	.	(15.2)	Limburg (B)
46.2	38.0	12.0	48.7	52.6	15.8	Oost-Vlaanderen
.	37.6	.	52.1	.	.	Vlaams Brabant
.	43.2	(17.2)	37.0	.	.	West-Vlaanderen
.	39.0	(24.7)	(32.0)	.	(26.3)	Brabant Wallon
(58.5)	15.2	9.2	74.9	68.3	18.8	Hainaut
(57.1)	24.6	12.7	61.7	62.6	24.5	Liège
.	.	.	(54.0)	.	.	Luxemburg (B)
.	25.6	(21.2)	50.4	(62.8)	45.1	Namur
16.4	61.6	17.8	20.2	16.0	4.9	DANMARK
16.4	61.6	17.8	20.2	16.0	4.9	.
18.9	34.0	15.1	50.8	48.7	6.7	DEUTSCHLAND
12.7	37.2	17.5	44.9	.	9.4	Stuttgart
16.6	36.9	12.2	50.3	.	.	Karlsruhe
.	40.8	15.2	43.1	.	.	Freiburg
.	34.9	.	54.2	.	.	Tübingen
9.7	39.4	15.7	44.3	.	.	Oberbayern
.	45.2	.	37.8	.	.	Niederbayern
.	35.6	.	47.9	.	.	Oberplatz
.	38.0	.	43.9	.	.	Oberfranken
19.6	38.4	.	47.9	.	.	Mittelfranken
.	36.1	.	44.9	.	.	Unterfranken
15.4	41.6	.	43.6	.	.	Schwaben
30.7	25.8	16.1	57.8	57.1	9.4	Berlin-West, Stadt
27.8	36.8	14.4	48.3	.	.	Berlin-Ost, Stadt
.	31.5	12.3	56.0	45.5	.	Brandenburg
24.1	35.6	.	48.6	.	.	Bremen
18.1	38.3	17.9	43.1	.	.	Hamburg
19.3	33.8	16.5	49.3	.	12.9	Darmstadt
.	30.7	.	49.9	.	.	Gießen
.	31.6	16.2	51.2	.	.	Kassel
.	31.6	17.5	50.6	.	.	Mecklenburg-Vorpommern
26.7	36.1	14.6	48.6	.	.	Braunschweig
22.8	31.6	13.0	54.8	.	.	Hannover
.	40.5	.	44.4	.	.	Lüneburg
.	33.9	21.3	44.1	.	.	Weser-Ems
19.9	38.4	15.8	45.5	48.0	8.3	Düsseldorf
17.5	33.2	17.1	49.3	.	8.6	Köln
24.7	33.8	15.4	50.3	50.0	10.1	Münster
16.8	37.6	13.7	47.9	.	.	Detmold
23.5	33.6	15.2	50.9	49.5	7.6	Arnsberg
.	39.7	.	41.3	.	.	Koblenz
.	Trier
.	28.2	.	59.1	.	.	Rheinessen-Pfalz
.	27.1	.	59.2	.	.	Saarland
40.1	29.2	14.5	56.1	58.7	.	Sachsen
.	31.0	14.0	54.1	.	.	Dessau
.	27.5	12.4	59.5	.	.	Halle
.	34.9	14.0	50.7	.	.	Magdeburg
20.7	37.1	18.7	43.7	.	10.2	Schleswig-Holstein
.	34.5	12.3	52.9	.	.	Thüringen
13.2	24.9	19.8	55.2	74.5	48.4	ELLADA ⁽¹⁾
.	29.4	22.6	45.7	(72.5)	34.2	Anatoliki Makedonia, Thraki
(17.7)	26.3	21.8	51.2	76.4	49.0	Kentriki Makedonia
.	(26.3)	.	53.4	(66.7)	57.0	Dytiki Makedonia
.	17.5	20.1	61.0	82.6	53.8	Thessalia
.	.	.	69.1	85.1	71.5	Ipeiros
.	Ionias Nisia
.	16.4	17.1	64.8	80.4	62.1	Dytiki Ellada
.	18.6	16.9	62.6	79.0	58.4	Sterea Ellada

(1) 1998.

Table 62

Main characteristics of unemployment by region

REGION	ALL UNEMPLOYMENT	UNEMPLOYMENT AGE 15-24	UNEMPLOYMENT AGE 25-64	UNEMPLOYMENT AGE 15-64	UNEMPLOYMENT NATIONALS	UNEMPLOYMENT EU-NATIONALS
	(Thousands)	(Rate)	(Rate)	(Rate)	(Rate)	(Rate)
Peloponnisos	18	28.3	5.9	8.6	8.2	.
Attiki	207	30.2	9.6	12.3	12.1	.
Voreio Aigaio	7	(31.4)	7.9	10.9	10.7	.
Notio Aigaio	7	.	5.2	6.5	6.3	.
Kriti	19	22.2	5.3	7.6	7.1	.
ESPAÑA	2 566	29.5	13.3	15.8	15.7	13.4
Galicia	182	32.2	14.3	16.5	16.3	.
Principado de Asturias	69	43.7	14.1	17.8	17.4	.
Cantabria	31	32.4	12.5	15.4	15.2	.
Pais Vasco	129	30.3	12.3	14.4	14.3	.
Comunidad Foral de Navarra	19	(15.1)	7.4	8.4	8.3	.
La Rioja	7	.	5.7	6.9	6.6	.
Aragón	45	16.5	8.4	9.5	9.2	.
Comunidad de Madrid	289	24.7	11.1	13.1	13.1	(27.3)
Castilla y León	152	35.2	12.7	15.4	15.3	.
Castilla-la Mancha	101	26.2	12.9	15.3	15.2	.
Extremadura	102	39.9	22.0	25.0	24.7	.
Cataluna	281	19.8	8.9	10.6	10.5	.
Comunidad Valenciana	232	26.1	11.6	14.0	13.9	.
Islas Baleares	23	14.4	6.0	7.1	7.2	.
Andalucia	735	41.9	22.9	26.4	26.2	.
Región de Murcia	62	26.5	11.3	14.0	14.2	.
Ceuta e Melilla	13	50.3	18.4	24.8	23.7	.
Canarias	95	28.9	11.3	14.1	14.1	.
FRANCE	3 127	26.5	10.5	12.1	11.4	10.5
Île de France	578	21.5	9.6	10.6	9.1	7.8
Champagne-Ardenne	73	30.4	11.2	13.3	12.5	.
Picardie	105	31.2	11.3	13.6	13.0	.
Haute-Normandie	118	36.2	11.4	14.2	13.6	.
Centre	114	21.1	9.8	11.0	10.5	.
Basse-Normandie	56	24.2	8.5	10.1	10.0	.
Bourgogne	74	23.4	9.1	10.5	9.9	.
Nord - Pas-de-Calais	300	42.5	15.0	18.3	17.8	.
Lorraine	111	24.0	9.8	11.2	10.9	.
Alsace	62	16.6	6.3	7.6	6.9	.
Franche-Comté	49	20.7	8.5	9.8	9.2	.
Pays de la Loire	184	24.0	10.9	12.4	12.0	.
Bretagne	126	25.3	8.2	9.7	9.4	.
Poitou-Charentes	77	29.0	8.9	11.0	10.7	.
Aquitaine	157	28.6	10.2	12.0	11.5	.
Midi-Pyrénées	120	27.2	9.5	11.3	10.3	.
Limousin	27	(26.0)	8.0	9.7	9.2	.
Rhône-Alpes	252	21.7	8.8	10.1	9.6	(13.0)
Auvergne	57	30.6	8.7	10.8	10.4	.
Languedoc-Roussillon	148	31.7	15.7	17.6	16.0	.
Provence-Alpes-Côte d'Azur	313	29.3	15.6	17.1	15.9	(17.5)
Corse	26	(49.6)	23.9	26.4	23.1	.
Guadeloupe	-	-	-	-	-	-
Martinique	-	-	-	-	-	-
Guyane	-	-	-	-	-	-
Réunion	-	-	-	-	-	-
IRELAND	96	8.4	5.2	5.8	5.6	(7.3)
Border, Midlands and Western	29	9.9	6.4	7.1	6.7	.
Southern and Eastern	68	7.9	4.8	5.4	5.3	.
ITALIA	2 729	32.9	9.1	11.8	11.7	.
Piemonte	144	22.4	6.0	7.8	7.7	.
Valle d'Aosta
Liguria	70	31.2	8.5	10.7	10.7	.
Lombardia	195	13.7	3.7	4.9	4.9	.
Trentino - Alto Adige	16	(7.4)	3.3	3.8	3.7	.
Veneto	95	11.5	3.9	4.9	4.8	.

(2) 1997.

Table 62

Main characteristics of unemployment by region

UNEMPLOYMENT NON-EU-NATIONALS (Rate)	UNEMPLOYMENT < 6 MONTHS (% all Unemp.)	UNEMPLOYMENT 6 -11 MONTHS (% all Unemp.)	UNEMPLOYMENT 12+ MONTHS (% all Unemp.)	UNEMPLOYMENT (AGED 15-24) 6+ MONTHS (% young Unemp.)	SEEK FIRST JOB (% all Unemp.)	REGION
12.7	(17.6) 27.3	19.5	68.0 52.9	79.7 70.5	65.8 40.6	Peloponnisos Attiki
.	.	.	60.2	.	(46.7)	Voreio Aigaio
.	(40.8) 28.6	(22.7)	46.1	68.5	57.2	Notio Aigaio Kriti
14.7	34.0	19.6	46.3	59.2	23.9	ESPAÑA
.	26.4	19.5	53.8	59.6	29.7	Galicia
.	22.9	20.7	55.7	73.6	34.4	Principado de Asturias
.	21.7	18.2	58.4	63.4	36.7	Cantabria
.	31.3	17.3	51.0	55.6	26.3	Pais Vasco
.	29.9	(23.1)	44.3	.	(19.2)	Comunidad Foral de Navarra
.	.	.	(52.1)	.	.	La Rioja
.	37.4	19.5	42.0	53.8	17.6	Aragón
(7.6)	28.0	22.0	49.9	64.8	24.6	Comunidad de Madrid
.	30.3	21.0	48.3	60.6	26.2	Castilla y León
.	35.5	24.7	39.2	61.8	21.6	Castilla-la Mancha
.	43.7	21.6	34.3	53.8	22.9	Extremadura
15.5	28.2	18.9	52.8	59.2	20.4	Cataluna
.	39.1	19.6	41.1	52.5	19.6	Comunidad Valenciana
.	34.8	23.9	39.1	(65.5)	(18.3)	Islas Baleares
.	38.1	18.1	43.6	60.5	23.3	Andalucia
.	40.3	18.3	40.6	50.6	25.2	Región de Murcia
.	(25.0)	.	54.2	(63.5)	41.7	Ceuta e Melilla
.	43.6	18.3	37.5	49.6	21.6	Canarias
30.5	47.0	14.3	38.6	36.3	11.6	FRANCE
26.1	41.2	16.1	42.6	41.4	11.6	Île de France
(40.7)	46.8	15.3	37.3	(37.4)	16.1	Champagne-Ardenne
36.5	48.5	17.1	33.9	40.7	11.5	Picardie
(45.1)	48.6	14.3	36.6	39.3	12.2	Haute-Normandie
(30.3)	52.3	14.8	32.5	(20.7)	9.5	Centre
.	48.4	(14.2)	36.4	(28.9)	(9.6)	Basse-Normandie
(39.4)	47.0	(11.3)	40.9	(25.3)	(11.1)	Bourgogne
41.6	38.8	15.7	45.3	43.5	15.8	Nord - Pas-de-Calais
(29.6)	47.0	14.7	37.9	36.6	11.9	Lorraine
(23.4)	54.2	(13.5)	31.4	(31.0)	(8.6)	Alsace
(22.5)	57.8	(14.6)	26.4	.	(9.0)	Franche-Comté
(44.4)	50.3	15.8	33.6	32.6	10.7	Pays de la Loire
.	59.3	12.3	28.1	(25.8)	8.8	Bretagne
.	54.8	11.5	33.0	(27.1)	12.5	Poitou-Charentes
(40.9)	51.1	12.6	36.0	32.3	10.4	Aquitaine
45.2	41.9	14.9	42.7	41.3	11.2	Midi-Pyrénées
.	47.7	(15.4)	35.0	.	.	Limousin
20.8	56.7	12.3	30.8	30.0	10.2	Rhône-Alpes
.	49.5	(10.2)	39.3	(34.6)	(14.4)	Auvergne
52.5	42.8	12.7	44.1	48.1	12.3	Languedoc-Roussillon
38.2	42.5	13.3	44.0	39.1	11.0	Provence-Alpes-Côte d'Azur
(48.4)	50.1	.	43.6	.	.	Corse
-	-	-	-	-	-	Guadeloupe
-	-	-	-	-	-	Martinique
-	-	-	-	-	-	Guyane
-	-	-	-	-	-	Réunion
.	19.6 ⁽²⁾	13.1 ⁽²⁾	67.2 ⁽²⁾	42.7 ⁽²⁾	.	IRELAND
.	-	-	-	-	.	Border, Midlands and Western
.	-	-	-	-	.	Southern and Eastern
6.7	23.8	15.6	60.6	76.9	52.0	ITALIA
.	25.6	16.5	57.6	69.2	33.7	Piemonte
.	Valle d'Aosta
.	23.9	13.7	61.7	80.0	41.6	Liguria
.	36.0	19.3	44.4	60.0	36.1	Lombardia
.	68.2	Trentino - Alto Adige
.	42.6	26.3	30.6	56.9	27.9	Veneto

(2) 1997.

Table 62

Main characteristics of unemployment by region

REGION	ALL UNEMPLOY- MENT (Thousands)	UNEMPLOY- MENT AGE 15-24 (Rate)	UNEMPLOY- MENT AGE 25-64 (Rate)	UNEMPLOY- MENT AGE 15-64 (Rate)	UNEMPLOY- MENT NATIONALS (Rate)	UNEMPLOY- MENT EU- NATIONALS (Rate)
Friuli - Venezia Giulia	27	(12.1)	4.8	5.5	5.4	.
Emilia-Romagna	86	12.7	4.0	4.8	4.8	.
Toscana	119	20.8	6.7	8.1	8.1	.
Umbria	24	(19.9)	5.7	7.1	6.9	.
Marche	39	18.0	5.1	6.4	6.4	.
Lazio	277	46.9	9.9	13.0	13.0	.
Abruzzo	51	31.6	8.4	10.5	10.4	.
Molise	21	(50.4)	12.3	16.5	16.3	.
Campania	472	60.9	17.5	23.4	23.2	.
Puglia	285	49.0	14.6	19.7	19.4	.
Basilicata	36	52.8	12.8	17.1	16.9	.
Calabria	207	65.2	23.3	28.3	28.1	.
Sicilia	423	60.2	18.7	24.5	24.3	.
Sardegna	141	56.7	16.9	21.7	21.5	.
LUXEMBOURG (Grand-Duché)	4	(6.8)	1.9	2.4	1.6	3.0
NEDERLAND	286	7.4	2.9	3.6	3.4	(3.3)
Groningen	18	(13.2)	5.1	6.6	6.4	.
Friesland	12	(9.5)	(2.9)	4.1	3.8	.
Drenthe	19	(15.8)	7.1	8.4	7.8	.
Overijssel	16	(7.1)	(2.3)	3.1	2.9	.
Gelderland	32	7.4	2.6	3.4	3.2	.
Flevoland	(6)	.	(3.5)	(4.0)	(3.6)	.
Utrecht	15	.	2.6	2.6	2.4	.
Noord-Holland	47	7.2	3.1	3.7	3.3	.
Zuid-Holland	58	7.9	2.6	3.5	3.2	.
Zeeland	11	.	(5.3)	6.0	(5.3)	.
Noord-Brabant	33	5.8	2.2	2.8	2.7	.
Limburg (NL)	18	(6.8)	2.7	3.3	3.1	.
ÖSTERREICH	181	5.9	4.5	4.7	4.3	.
Burgenland	6	.	4.7	5.0	4.7	.
Niederösterreich	31	4.4	4.4	4.4	4.2	.
Wien	54	7.9	6.5	6.7	6.4	.
Kärnten	10	.	3.9	4.1	3.9	.
Steiermark	24	5.4	4.1	4.3	4.1	.
Oberösterreich	30	7.2	4.3	4.7	3.8	.
Salzburg	8	.	3.0	3.1	2.5	.
Tirol	10	5.1	3.0	3.3	2.8	.
Vorarlberg	8	7.3	4.0	4.6	4.1	.
PORTUGAL	233	9.1	4.1	4.9	4.5	.
Norte	83	7.6	4.1	4.8	4.5	.
Centro (P)	22	6.9	2.0	2.7	2.4	.
Lisboa e Vale do Tejo	99	11.7	5.2	6.1	5.7	.
Alentejo	14	16.5	5.1	6.7	6.4	.
Algarve	6	.	(2.9)	3.8	3.7	.
Açores	(4)	.	.	(3.6)	(3.6)	.
Madeira	(4)	.	(2.8)	(3.4)	(3.3)	.
SUOMI/FINLAND	309	28.6	8.7	11.8	11.5	.
Uusimaa	51	41.9	11.6	16.0	15.9	.
Etelä-Suomi	48	33.7	10.3	14.1	13.8	.
Itä-Suomi	46	36.3	12.6	16.8	16.7	.
Väli-Suomi	54	18.3	5.2	7.1	6.9	.
Pohjois-Suomi	110	27.7	9.1	11.9	11.6	.
Ahvenanmaa/Åland
SVERIGE	334	16.3	6.7	7.7	7.2	.
Stockholm	34	.	3.5	3.9	3.7	.
Östra Mellansverige	63	20.9	7.0	8.5	7.8	.
Småland med Öarna	54	20.5	7.5	8.9	8.5	.
Sydsverige	47	23.5	9.9	11.2	10.5	.
Västsverige	16	.	7.9	8.5	8.4	.

Table 62

Main characteristics of unemployment by region

UNEMPLOY- MENT NON-EU- NATIONALS (Rate)	UNEMPLOY- MENT < 6 MONTHS (% all Unemp.)	UNEMPLOY- MENT 6 -11 MONTHS (% all Unemp.)	UNEMPLOY- MENT 12+ MONTHS (% all Unemp.)	UNEMPLOYM. (AGED 15-24) 6+ MONTHS (% young Unemp.)	SEEK FIRST JOB (% all Unemp.)	REGION
.	43.2	(22.1)	32.7	.	(25.3)	Friuli - Venezia Giulia
.	44.9	27.1	27.4	40.6	20.7	Emilia-Romagna
.	34.0	22.2	43.4	68.6	35.1	Toscana
.	31.1	.	54.0	.	43.3	Umbria
.	28.2	22.7	47.8	64.5	30.7	Marche
.	16.4	13.9	69.5	82.4	54.1	Lazio
.	16.4	18.9	63.6	75.4	51.8	Abruzzo
.	(18.2)	.	65.5	.	63.5	Molise
.	13.9	11.7	74.3	86.0	74.1	Campania
.	24.2	12.7	62.9	78.2	58.1	Puglia
.	22.6	(19.4)	56.5	85.2	52.6	Basilicata
.	22.2	14.3	63.3	85.3	55.3	Calabria
.	19.9	12.4	67.6	84.1	58.8	Sicilia
.	21.8	19.0	58.9	77.0	44.6	Sardegna
(7.9)	41.4	(19.2)	(28.9)	.	(21.4)	LUXEMBOURG (Grand-Duché)
18.5	30.0	32.2	37.6	54.0	37.1	NEDERLAND
.	.	(33.5)	(42.0)	.	(43.3)	Groningen
.	.	.	(42.7)	.	(41.0)	Friesland
.	(32.8)	(33.4)	(30.8)	.	(36.2)	Drenthe
.	(34.4)	(32.2)	(30.1)	.	(38.9)	Overijssel
.	34.5	(28.3)	35.5	(41.3)	43.6	Gelderland
.	Flevoland
.	.	(34.8)	(43.8)	.	.	Utrecht
(22.3)	27.9	31.6	39.5	(56.4)	36.5	Noord-Holland
(17.9)	29.1	34.4	35.7	54.8	38.2	Zuid-Holland
.	.	(46.2)	.	.	.	Zeeland
.	35.5	(26.9)	36.0	(42.5)	35.6	Noord-Brabant
.	(29.2)	(24.6)	(43.3)	.	(34.0)	Limburg (NL)
9.5	52.2	15.9	31.6	31.4	9.9	ÖSTERREICH
.	55.6	Burgenland
7.2	53.7	16.7	28.1	.	.	Niederösterreich
8.5	38.4	14.6	46.1	37.7	10.9	Wien
.	45.4	23.0	26.9	.	.	Kärnten
.	59.9	8.9	29.1	.	9.6	Steiermark
20.9	58.7	18.9	20.8	.	9.3	Oberösterreich
7.6	54.7	Salzburg
9.9	62.7	.	24.6	.	.	Tirol
.	55.4	Vorarlberg
14.2	36.6	22.4	40.8	52.6	15.0	PORTUGAL
.	37.5	20.5	41.5	52.9	15.2	Norte
.	48.5	(13.6)	35.6	(39.5)	(11.9)	Centro (P)
20.4	32.7	26.0	40.7	52.6	13.8	Lisboa e Vale do Tejo
.	36.4	(20.2)	40.0	(71.8)	(22.8)	Alentejo
.	.	.	(39.5)	.	.	Algarve
.	Açores
.	Madeira
27.6	63.6	14.1	22.2	11.8	16.5	SUOMI/FINLAND
.	65.0	16.0	18.1	(15.4)	16.8	Uusimaa
.	63.4	13.8	21.8	.	19.8	Etelä-Suomi
.	65.0	14.8	19.2	.	16.6	Itä-Suomi
(22.6)	64.5	11.7	22.9	.	18.3	Väli-Suomi
(37.6)	60.9	13.8	24.8	13.2	13.8	Pohjois-Suomi
.	Ahvenanmaa/Åland
28.4	53.5	17.4	29.0	27.0	10.2	SVERIGE
.	65.0	Stockholm
.	52.1	19.5	27.7	.	.	Östra Mellansverige
.	52.9	.	33.8	.	.	Småland med Öarna
.	53.0	.	29.7	.	.	Sydsverige
.	56.9	Västsverige

Table 62

Main characteristics of unemployment by region

REGION	ALL UNEMPLOY- MENT (Thousands)	UNEMPLOY- MENT AGE 15-24 (Rate)	UNEMPLOY- MENT AGE 25-64 (Rate)	UNEMPLOY- MENT AGE 15-64 (Rate)	UNEMPLOY- MENT NATIONALS (Rate)	UNEMPLOY- MENT EU- NATIONALS (Rate)
Norra Mellansverige	28	.	11.4	11.6	11.6	.
Mellersta Norrland	30	.	6.7	7.5	6.8	.
Övre Norrland	61	14.7	6.2	7.1	6.0	.
UNITED KINGDOM	1 782	12.7	5.1	6.2	6.0	7.3
Tees Valley & Durham	56	20.6	9.1	10.9	10.8	.
Northumbria, Tyne and Wear	63	18.0	8.7	10.0	10.0	.
Cumbria	16	.	5.9	6.7	6.4	.
Cheshire	23	.	3.5	4.7	4.5	.
Greater Manchester	79	15.9	4.7	6.5	6.2	.
Lancashire	29	.	3.4	4.3	4.4	.
Merseyside	58	18.5	8.4	9.9	9.6	.
East Riding & North Lincolnshire	37	19.0	6.8	8.9	8.8	.
North Yorkshire	15	.	3.4	4.0	3.9	.
South Yorkshire	49	14.5	7.0	8.1	7.8	.
West Yorkshire	62	10.1	5.4	6.1	5.9	.
Derbyshire, Nottinghamshire	56	14.6	4.2	5.8	5.7	.
Leicestershire, Northamptonshire	40	13.3	3.4	4.9	4.8	.
Lincolnshire	15	.	.	4.8	4.7	.
Herefordsh., Worcestersh. & Warks	31	.	4.0	5.0	4.8	.
Shropshire, Staffordshire	49	13.2	5.1	6.4	6.1	.
West Midlands	103	15.4	7.3	8.6	8.3	.
East Anglia	45	8.4	3.4	4.2	4.1	.
Bedfordshire, Hertfordshire	34	11.2	3.0	4.2	4.2	.
Essex	36	.	4.1	4.5	4.3	.
Inner London	128	17.6	8.4	9.6	8.7	.
Outer London	147	12.3	5.6	6.7	6.2	.
Berkshire, Bucks, Oxfordshire	29	.	2.6	2.6	2.6	.
Surrey, East-West Sussex	46	6.1	3.2	3.6	3.6	.
Hampshire, Isle of Wight	43	11.6	3.6	4.8	4.7	.
Kent	36	10.0	3.8	4.7	4.5	.
Avon, Gloucestersh., Wiltsh. & NS	37	8.3	2.5	3.4	3.3	.
Dorset, Somerset	31	13.3	4.0	5.3	5.0	.
Cornwall & Isles of Scilly	18	.	7.4	8.1	8.1	.
Devon	35	16.1	5.1	6.8	6.7	.
West Wales & the Valleys	62	17.3	6.0	7.9	7.8	.
East Wales	34	17.6	4.6	6.6	6.6	.
North Eastern Scotland	13	.	.	5.2	5.0	.
Eastern Scotland	63	17.0	4.9	6.7	6.7	.
South Western Scotland	96	19.5	7.3	9.2	9.2	.
Highlands, Islands	14	.	5.9	6.6	6.3	.
Northern Ireland	53	10.7	6.7	7.4	7.2	.

Table 62

Main characteristics of unemployment by region

UNEMPLOY- MENT NON-EU- NATIONALS (Rate)	UNEMPLOY- MENT < 6 MONTHS (% all Unemp.)	UNEMPLOY- MENT 6 -11 MONTHS (% all Unemp.)	UNEMPLOY- MENT 12+ MONTHS (% all Unemp.)	UNEMPLOYM. (AGED 15-24) 6+ MONTHS (% young Unemp.)	SEEK FIRST JOB (% all Unemp.)	REGION
.	43.3	.	36.5	.	.	Norra Mellansverige
.	56.7	Mellersta Norrland
46.0	48.4	22.2	28.6	.	.	Övre Norrland
11.5	54.3	15.9	29.8	32.2	14.6	UNITED KINGDOM
.	42.6	21.2	35.4	.	.	Tees Valley & Durham
.	46.4	20.5	32.3	.	.	Northumbria, Tyne and Wear
.	Cumbria
.	47.2	Cheshire
.	55.5	14.7	29.2	33.3	17.8	Greater Manchester
.	44.8	Lancashire
.	40.2	.	41.9	.	.	Merseyside
.	38.7	.	41.4	.	.	East Riding & North Lincolnshire
.	North Yorkshire
.	60.3	.	29.2	.	.	South Yorkshire
.	59.3	16.7	23.2	.	.	West Yorkshire
.	49.2	.	33.0	.	.	Derbyshire, Nottinghamshire
.	65.3	Leicestershire, Northamptonshire
.	Lincolnshire
.	61.3	Herefordsh.,Worcestersh.&Warks
.	64.4	Shropshire, Staffordshire
.	49.7	18.0	31.8	.	16.6	West Midlands
.	58.7	.	28.3	.	.	East Anglia
.	68.2	Bedfordshire, Hertfordshire
.	59.8	Essex
16.9	48.3	10.9	40.4	.	18.0	Inner London
10.6	55.8	14.5	29.4	28.2	14.6	Outer London
.	63.9	Berkshire,Bucks,Oxfordshire
.	60.3	.	26.5	.	.	Surrey, East-West Sussex
.	64.8	Hampshire, Isle of Wight
.	59.1	Kent
.	66.8	Avon,Gloucestersh.,Wiltsh.&NS
.	65.8	Dorset, Somerset
.	57.1	Cornwall & Isles of Scilly
.	54.0	Devon
.	58.5	17.1	23.7	.	.	West Wales & the Valleys
.	50.1	East Wales
.	North Eastern Scotland
.	50.0	21.1	28.2	.	17.2	Eastern Scotland
.	52.4	12.2	34.9	.	14.8	South Western Scotland
.	Highlands, Islands
.	37.3	.	53.1	.	19.0	Northern Ireland

INACTIVITY

GRAPH 17: Inactive population as percentage of the population in each age group
(EU-15*, 1999)

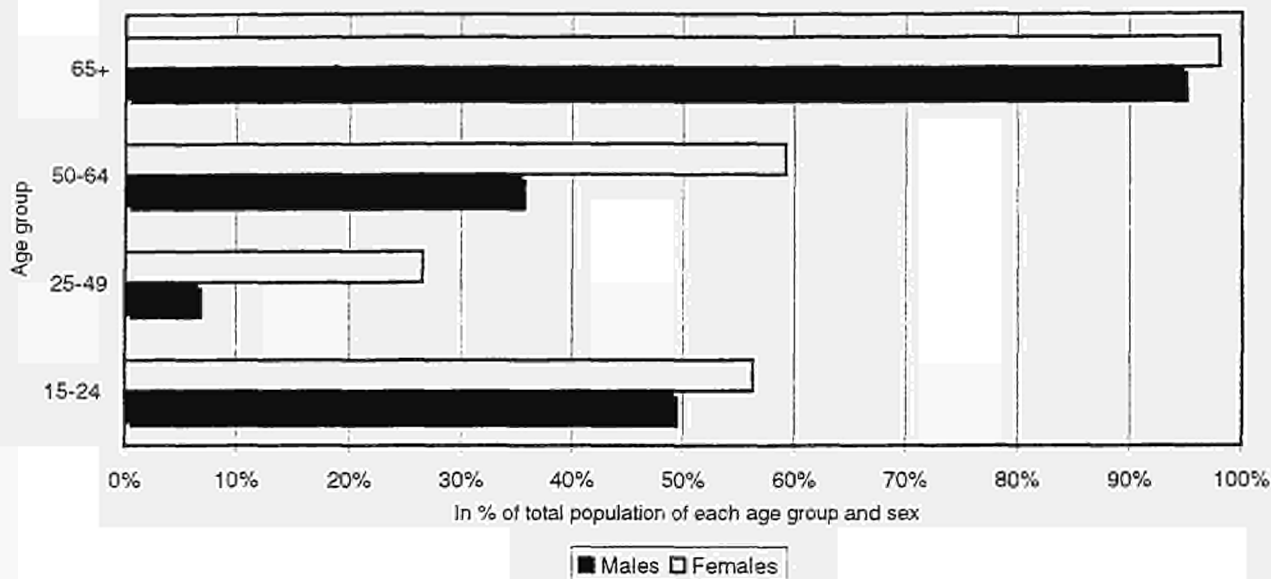

* Greece 1998

GRAPH 18: Proportion of inactive population who would like to work but think no job is available
(EU-15, 1999)

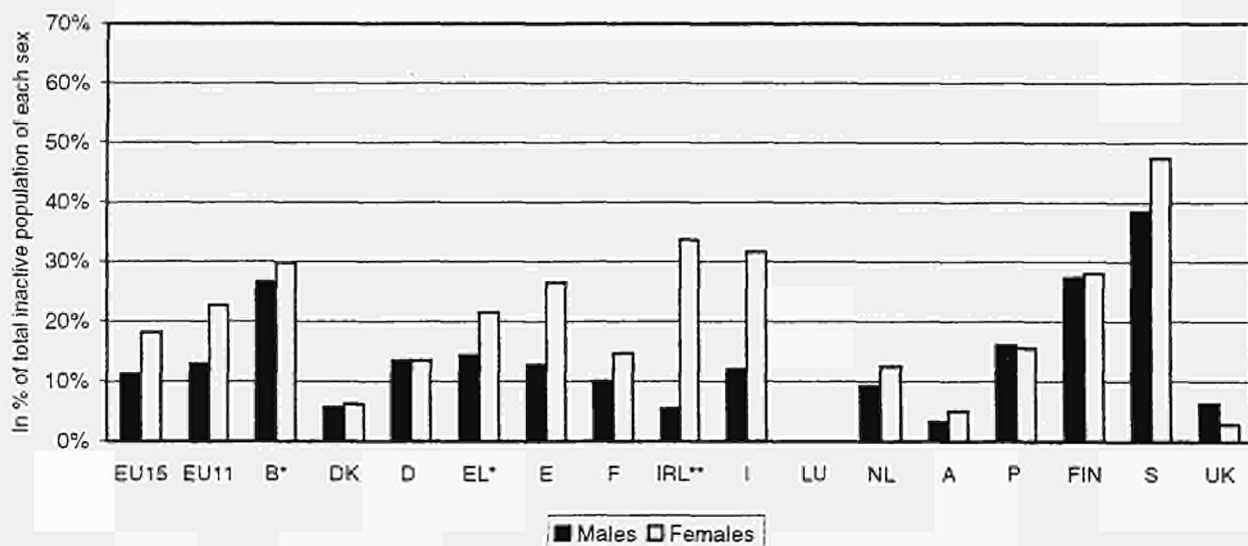

* 1998

** 1997

Table 63⁽¹⁾

Inactive population as percentage of the total population, by age group

Percentages of the total Male and/or Female population

	EU-15	EUR-11	B	DK	D	EL	E	F
Males and Females								
0-14 years	17.1	16.5	17.7	17.9	15.4	15.3	15.2	19.2
15-24 years	6.5	7.0	8.2	3.1	5.3	8.3	9.0	8.1
25-49 years	6.0	6.2	5.3	4.0	5.3	7.2	7.5	4.6
50-64 years	8.4	9.0	9.8	5.8	9.1	9.8	8.8	7.7
65 & + years	15.6	15.8	16.3	15.2	16.0	16.3	17.6	15.3
15-64 years	21.0	22.1	23.3	12.9	19.7	25.3	25.3	20.4
All ages	53.7	54.4	57.3	46.0	51.1	56.8	58.1	54.9
Males								
0-14 years	18.0	17.5	18.5	18.8	16.2	16.1	16.2	20.3
15-24 years	6.2	6.7	8.2	2.6	5.1	7.9	8.7	7.7
25-49 years	2.4	2.4	2.3	2.5	2.3	1.5	2.3	1.8
50-64 years	6.3	6.8	7.7	5.1	7.2	6.1	5.2	6.8
65 & + years	12.9	13.0	13.3	12.7	12.7	14.8	15.4	12.9
15-64 years	15.0	15.9	18.3	10.2	14.6	15.4	16.2	16.3
All ages	45.9	46.3	50.1	41.7	43.6	46.3	47.8	49.6
Females								
0-14 years	16.2	15.7	16.9	17.0	14.6	14.5	14.3	18.2
15-24 years	6.8	7.2	8.2	3.5	5.6	8.7	9.4	8.4
25-49 years	9.5	9.8	8.1	5.5	8.1	12.6	12.3	7.3
50-64 years	10.4	11.0	11.8	6.6	10.8	13.4	12.2	8.5
65 & + years	18.1	18.4	19.1	17.6	19.1	17.7	19.6	17.5
15-64 years	26.7	28.1	28.1	15.6	24.5	34.6	33.9	24.2
All ages	61.0	62.1	64.1	50.2	58.2	66.8	67.8	60.0

⁽¹⁾ These percentages were calculated in the way as the percentages of the NEWCRONOS table *ip_ga*.⁽²⁾ 1998.⁽³⁾ Greece 1998.

(1) Table 63

Inactive population as percentage of the total population, by age group

Percentages of the total Male and/or Female population

IRL	I	L	NL	A	P	FIN	S	UK	
Males and Females									
22.1	14.6	18.7	18.8	17.4	17.1	18.4	18.5	19.8	0-14 years
8.7	7.6	7.6	3.9	4.8	8.3	4.6	6.7	4.4	15-24 years
7.2	8.8	8.0	5.9	5.3	5.0	4.1	4.2	5.6	25-49 years
6.5	11.1	9.2	8.3	9.1	6.5	7.1	4.2	6.3	50-64 years
10.4	16.9	13.9	12.4	14.7	12.3	14.4	16.8	14.4	65 & + years
22.4	27.5	24.8	18.1	19.2	19.8	15.8	15.1	16.2	15-64 years
54.9	59.0	57.5	49.2	51.3	49.2	48.6	50.4	50.4	All ages
Males									
22.9	15.5	19.2	19.3	18.5	18.2	19.3	19.2	20.7	0-14 years
8.2	7.2	7.5	4.0	4.4	8.0	4.4	6.8	4.1	15-24 years
2.6	3.0	2.0	2.3	2.2	2.2	3.1	3.5	2.7	25-49 years
3.9	8.0	7.1	5.9	7.0	4.2	7.0	3.7	4.7	50-64 years
8.3	14.0	12.3	10.3	11.4	9.7	11.1	13.9	11.9	65 & + years
14.6	18.3	16.6	12.2	13.6	14.4	14.6	14.0	11.5	15-64 years
45.8	47.8	48.0	41.8	43.4	42.3	45.0	47.1	44.1	All ages
Females									
21.4	13.8	18.3	18.2	16.4	16.1	17.5	17.8	19.0	0-14 years
9.1	7.9	7.6	3.8	5.2	8.6	4.7	6.6	4.7	15-24 years
11.8	14.2	13.9	9.4	8.1	7.6	5.0	5.0	8.3	25-49 years
9.1	13.9	11.4	10.7	11.1	8.6	7.2	4.6	7.9	50-64 years
12.4	19.6	15.5	14.5	17.8	14.7	17.6	19.6	16.7	65 & + years
30.1	36.1	32.9	23.9	24.4	24.8	16.9	16.2	20.8	15-64 years
63.8	69.5	66.7	56.6	58.6	55.6	52.1	53.6	56.6	All ages

 (1) These percentages were calculated in the same way as the percentages of the NEWCRONOS table *ip_ga*.

Table 64

Inactive population by age group and nationality

Thousands

	EU-15 ⁽²⁾	EUR-11	B	DK	D	EL ⁽¹⁾	E	F
Males and Females								
0-14 years	63 177	47 471	1 805	945	12 481	1 570	5 948	11 047
Nationals	60 106	44 859	1 668	888	10 954	1 508	5 900	10 559
Non-Nationals/EU-Nationals	584	522	52	5	278	.	12	94
Non-National/NonEU-Nationals	2 486	2 090	85	51	1 248	61	36	393
15-24 years	24 173	20 029	838	162	4 321	851	3 528	4 632
Nationals	22 886	18 961	753	153	3 746	832	3 504	4 397
Non-Nationals/EU-Nationals	280	220	36	.	103	.	5	39
Non-National/NonEU-Nationals	1 008	848	48	9	472	18	19	196
25-49 years	22 302	17 735	540	213	4 260	737	2 917	2 661
Nationals	20 182	16 050	420	183	3 422	712	2 878	2 264
Non-Nationals/EU-Nationals	427	339	50	.	145	(3)	17	68
Non-National/NonEU-Nationals	1 693	1 346	70	27	693	22	22	328
50-64 years	31 143	25 796	1 001	307	7 322	1 013	3 436	4 427
Nationals	29 960	24 792	913	301	6 873	1 005	3 409	4 107
Non-Nationals/EU-Nationals	480	387	58	.	133	.	22	128
Non-National/NonEU-Nationals	703	616	31	(4)	316	7	(5)	192
65 & + years	57 670	45 346	1 665	802	12 928	1 672	6 864	8 769
Nationals	56 701	44 643	1 584	791	12 719	1 664	6 833	8 485
Non-Nationals/EU-Nationals	561	412	72	.	90	.	25	172
Non-National/NonEU-Nationals	408	291	9	8	118	7	7	111
Males								
0-14 years	32 455	24 373	924	493	6 414	806	3 068	5 662
Nationals	30 852	23 009	850	464	5 600	773	3 041	5 416
Non-Nationals/EU-Nationals	306	273	29	.	151	.	7	48
Non-National/NonEU-Nationals	1 297	1 091	45	27	663	32	21	199
15-24 years	11 271	9 345	409	69	2 017	394	1 636	2 149
Nationals	10 717	8 886	375	65	1 760	389	1 628	2 050
Non-Nationals/EU-Nationals	125	99	16	.	46	.	(4)	15
Non-National/NonEU-Nationals	430	360	18	(3)	211	5	(5)	83
25-49 years	4 371	3 288	117	66	907	73	441	495
Nationals	3 913	2 951	88	57	736	72	438	432
Non-Nationals/EU-Nationals	87	62	10	.	25	.	.	14
Non-National/NonEU-Nationals	371	275	19	9	146	.	.	49
50-64 years	11 443	9 507	386	133	2 841	307	973	1 905
Nationals	10 934	9 061	349	130	2 645	304	963	1 752
Non-Nationals/EU-Nationals	203	167	23	.	58	.	9	59
Non-National/NonEU-Nationals	306	278	15	.	138	.	.	94
65 & + years	23 287	18 179	666	333	5 020	741	2 907	3 586
Nationals	22 792	17 801	627	329	4 904	738	2 892	3 425
Non-Nationals/EU-Nationals	277	212	34	.	51	.	13	88
Non-National/NonEU-Nationals	219	166	(4)	(4)	65	(3)	.	73
Females								
0-14 years	30 722	23 097	881	452	6 067	764	2 880	5 384
Nationals	29 254	21 850	818	425	5 354	735	2 859	5 144
Non-Nationals/EU-Nationals	278	249	24	(3)	127	.	5	47
Non-National/NonEU-Nationals	1 189	998	40	24	585	29	15	194
15-24 years	12 902	10 685	429	93	2 304	457	1 892	2 483
Nationals	12 169	10 075	378	88	1 986	444	1 877	2 347
Non-Nationals/EU-Nationals	155	122	20	.	57	.	.	24
Non-National/NonEU-Nationals	578	488	30	5	261	13	14	112
25-49 years	17 931	14 447	423	146	3 353	664	2 476	2 166
Nationals	16 268	13 099	332	126	2 686	640	2 441	1 833
Non-Nationals/EU-Nationals	340	277	39	.	120	(3)	15	54
Non-National/NonEU-Nationals	1 323	1 071	51	18	547	20	21	279
50-64 years	19 700	16 288	615	174	4 482	707	2 463	2 522
Nationals	19 025	15 731	564	171	4 228	701	2 446	2 355
Non-Nationals/EU-Nationals	277	220	35	.	76	.	13	69
Non-National/NonEU-Nationals	397	338	16	.	178	5	(4)	98
65 & + years	34 383	27 167	999	469	7 908	931	3 957	5 183
Nationals	33 909	26 842	957	463	7 816	926	3 941	5 060
Non-Nationals/EU-Nationals	284	200	37	.	39	.	12	84
Non-National/NonEU-Nationals	189	126	5	5	53	(4)	(4)	39

⁽¹⁾ 1998.⁽²⁾ Greece 1998.

Table 64

Inactive population by age group and nationality

Thousands

IRL	I	L	NL	A	P	FIN	S	UK	
Males and Females									
829	8 332	79	2 913	1 379	1 709	947	1 636	11 555	0-14 years
810	8 296	49	2 786	1 204	1 692	939	1 539	11 313	Nationals
13	.	26	30	11	(3)	.	.	56	Non-Nationals/EU-Nationals
6	34	4	98	164	14	8	98	187	Non-National/NonEU-Nationals
324	4 307	32	604	381	826	236	590	2 541	15-24 years
315	4 287	19	548	349	811	233	559	2 381	Nationals
5	.	11	(9)	4	5	.	.	51	Non-Nationals/EU-Nationals
(4)	19	2	48	29	9	(3)	24	108	Non-National/NonEU-Nationals
271	5 014	34	914	417	499	209	376	3 241	25-49 years
255	4 963	21	789	346	491	200	324	2 913	Nationals
10	(7)	10	22	6	(3)	.	.	74	Non-Nationals/EU-Nationals
6	44	3	103	64	5	9	44	254	Non-National/NonEU-Nationals
244	6 301	39	1 290	721	648	366	368	3 659	50-64 years
237	6 283	29	1 237	696	644	364	340	3 521	Nationals
7	(4)	10	19	5	.	.	10	80	Non-Nationals/EU-Nationals
.	14	(1)	34	20	.	.	18	58	Non-National/NonEU-Nationals
388	9 610	59	1 930	1 165	1 228	742	1 485	8 365	65 & + years
379	9 589	46	1 907	1 142	1 221	739	1 457	8 145	Nationals
7	(4)	12	14	11	(3)	.	9	136	Non-Nationals/EU-Nationals
.	17	(1)	(8)	12	(4)	.	19	83	Non-National/NonEU-Nationals
Males									
426	4 286	40	1 488	706	875	483	840	5 943	0-14 years
417	4 271	25	1 427	618	865	480	790	5 817	Nationals
6	.	13	13	5	.	.	.	30	Non-Nationals/EU-Nationals
(3)	16	2	49	82	8	(3)	50	96	Non-National/NonEU-Nationals
152	1 994	16	310	169	382	111	297	1 166	15-24 years
149	1 987	9	287	157	375	110	284	1 094	Nationals
.	.	5	(5)	.	(3)	.	.	22	Non-Nationals/EU-Nationals
.	(6)	(1)	18	11	(4)	.	11	50	Non-National/NonEU-Nationals
43	833	4	175	83	107	78	153	790	25-49 years
43	829	3	132	71	106	76	134	699	Nationals
.	.	(1)	20	Non-Nationals/EU-Nationals
(3)	.	.	40	11	.	.	15	70	Non-National/NonEU-Nationals
72	2 219	15	453	266	202	175	161	1 336	50-64 years
69	2 211	11	429	256	201	174	147	1 291	Nationals
(3)	.	4	(8)	2	.	.	.	29	Non-Nationals/EU-Nationals
.	(6)	.	16	8	.	.	.	16	Non-National/NonEU-Nationals
155	3 848	26	794	436	465	276	607	3 427	65 & + years
151	3 841	18	780	426	463	275	595	3 329	Nationals
(3)	.	7	(8)	5	.	.	.	60	Non-Nationals/EU-Nationals
.	(6)	(1)	(6)	5	.	.	.	39	Non-National/NonEU-Nationals
Females									
404	4 046	39	1 425	673	834	464	796	5 612	0-14 years
394	4 026	24	1 359	586	827	459	749	5 496	Nationals
7	.	13	17	5	.	.	.	26	Non-Nationals/EU-Nationals
(3)	18	2	49	82	5	(4)	47	91	Non-National/NonEU-Nationals
171	2 314	16	294	212	444	125	293	1 375	15-24 years
166	2 300	10	261	192	436	123	275	1 288	Nationals
(3)	.	6	.	(3)	.	.	.	29	Non-Nationals/EU-Nationals
.	13	(1)	29	18	5	.	14	58	Non-National/NonEU-Nationals
223	4 181	30	739	333	392	131	223	2 452	25-49 years
212	4 134	18	657	276	385	124	189	2 214	Nationals
8	(6)	9	19	5	(3)	.	.	53	Non-Nationals/EU-Nationals
(3)	41	3	63	53	(4)	7	28	184	Non-National/NonEU-Nationals
172	4 083	24	837	455	446	191	208	2 323	50-64 years
168	4 072	18	809	440	443	189	193	2 229	Nationals
(4)	.	6	11	3	.	.	.	51	Non-Nationals/EU-Nationals
.	8	.	18	12	.	.	10	42	Non-National/NonEU-Nationals
233	5 762	33	1 135	729	763	465	878	4 938	65 & + years
228	5 748	27	1 127	716	758	464	862	4 817	Nationals
(4)	.	5	(7)	6	.	.	.	76	Non-Nationals/EU-Nationals
.	11	(1)	.	7	(3)	.	10	44	Non-National/NonEU-Nationals

(1) 1998.

(2) Greece 1998.

Table 65
Inactive population, aged 15 years or more, by willingness to work and by reasons for not seeking employment

	EU-15 ⁽²⁾	EUR-11 ³	B ⁽¹⁾	DK	D	EL ⁽¹⁾	E	F
	<i>Thousands</i>							
	Males and Females							
Not seeking employment but:	132 034	106 001	4 035	1 452	28 135	4 204	16 601	20 160
Would like to have a job	8 629	6 076	247	115	1 221	108	928	286
Do not want to have a job	120 396	98 962	3 788	1 338	26 788	4 096	15 140	19 615
Non responses	3 009	963	0	0	127	0	533	260
Not seeking a job because:	132 034	106 001	4 035	1 452	28 135	4 204	16 601	20 160
Awaiting recall to work (lay-off)	.	47	7	.	18	.	(4)	.
Own illness or disability	8 648	5 609	259	132	1 143	153	1 182	122
Personal/family responsibilities	18 957	15 619	645	48	3 749	754	2 762	150
Education or training	22 155	19 120	822	215	4 376	759	3 457	4 496
Retirement	52 249	38 665	1 976	993	16 630	1 718	4 689	36
Belief that no work is available	1 361	1 189	70	7	165	22	208	37
Other reasons	10 622	8 951	256	53	2 045	779	4 299	408
No reason	17 993	16 800	.	(3)	9	19	.	14 911
All in Inactivity	135 359	108 974	4 111	1 484	28 831	4 274	16 745	20 488
	Males							
Not seeking employment but:	49 021	39 113	1 567	590	10 434	1 495	5 899	8 013
Would like to have a job	2 971	1 946	113	35	410	21	280	100
Do not want to have a job	44 663	36 701	1 454	555	9 977	1 474	5 353	7 785
Non responses	1 387	466	0	0	47	0	266	128
Not seeking a job because:	49 021	39 113	1 567	590	10 434	1 495	5 899	8 013
Awaiting recall to work (lay-off)	(3)	.
Own illness or disability	4 178	2 576	144	51	598	74	589	60
Personal/family responsibilities	522	337	15	5	116	(4)	27	19
Education or training	10 762	9 286	409	81	2 180	378	1 634	2 132
Retirement	25 061	19 435	913	433	7 088	1 006	3 381	20
Belief that no work is available	334	251	30	.	55	(3)	36	10
Other reasons	1 493	1 137	55	15	387	25	229	177
No reason	6 646	6 068	.	.	.	(4)	.	5 597
All in Inactivity	50 390	40 336	1 594	601	10 784	1 515	5 957	8 135
	Females							
Not seeking employment but:	83 013	66 887	2 469	862	17 701	2 710	10 702	12 147
Would like to have a job	5 658	4 130	134	80	811	88	648	185
Do not want to have a job	75 733	62 261	2 334	783	16 811	2 622	9 787	11 830
Non responses	1 623	496	0	0	79	0	267	132
Not seeking a job because:	83 013	66 887	2 469	862	17 701	2 710	10 702	12 147
Awaiting recall to work (lay-off)	.	.	5	.	13	.	.	.
Own illness or disability	4 469	3 033	115	81	545	79	593	62
Personal/family responsibilities	18 435	15 282	630	43	3 633	750	2 734	131
Education or training	11 393	9 834	414	134	2 196	381	1 823	2 364
Retirement	27 188	19 230	1 064	559	9 542	713	1 309	16
Belief that no work is available	1 027	938	40	5	109	19	172	27
Other reasons	9 129	7 814	201	39	1 657	754	4 070	231
No reason	11 347	10 732	.	.	.	14	.	9 314
All in Inactivity	84 969	68 639	2 517	883	18 047	2 759	10 788	12 353

(1) 1998.

(2) Greece 1998, Belgium 1998.

(3) Belgium 1998.

Table 65

Inactive population aged 15 years or more, by willingness to work and by reasons for not seeking employment

Thousands

IRL	I	L	NL	A	P	FIN	S	UK	
Males and Females									
1 216	23 837	163	4 519	2 649	3 194	1 491	2 816	17 561	Not seeking employment but:
111	2 196	4	537	289	83	174	109	2 220	Would like to have a job
1 101	21 631	159	3 969	2 353	3 105	1 313	1 446	14 554	Do not want to have a job
3	9	0	13	8	6	5	1 260	787	Non responses
1 216	23 837	163	4 519	2 649	3 194	1 491	2 816	17 561	Not seeking a job because:
.	.	.	.	15	Awaiting recall to work (lay-off)
17	1 672	8	484	66	439	216	85	2 668	Own illness or disability
34	6 014	64	1 253	398	457	95	66	2 470	Personal/family responsibilities
43	4 078	32	469	408	754	184	652	1 409	Education or training
.	9 371	48	2 250	1 619	1 181	863	1 453	9 421	Retirement
.	575	.	61	13	13	48	47	95	Belief that no work is available
17	1 405	(1)	.	121	325	75	129	709	Other reasons
1 104	722	10	.	8	24	8	384	788	No reason
1 226	25 233	164	4 738	2 683	3 200	1 553	2 820	17 808	All in Inactivity
Males									
421	8 362	60	1 650	941	1 153	613	1 215	6 608	Not seeking employment but:
44	613	(1)	184	91	25	84	52	917	Would like to have a job
375	7 741	59	1 461	844	1 125	526	634	5 300	Do not want to have a job
1	8	0	5	5	4	2	530	391	Non responses
421	8 362	60	1 650	941	1 153	613	1 215	6 608	Not seeking a job because:
.	.	.	.	11	Awaiting recall to work (lay-off)
10	607	5	255	31	156	121	30	1 448	Own illness or disability
.	58	.	86	7	.	6	.	173	Personal/family responsibilities
21	2 007	17	249	193	356	88	313	704	Education or training
.	5 406	36	1 041	680	538	333	606	3 581	Retirement
.	73	.	17	3	(4)	23	20	58	Belief that no work is available
10	142	.	.	12	88	37	63	253	Other reasons
377	69	(1)	.	5	9	5	180	392	No reason
426	8 893	61	1 733	955	1 156	641	1 218	6 720	All in Inactivity
Females									
795	15 475	103	2 869	1 709	2 041	878	1 600	10 953	Not seeking employment but:
67	1 584	3	353	197	58	89	57	1 303	Would like to have a job
726	13 890	100	2 508	1 508	1 981	787	812	9 254	Do not want to have a job
1	1	0	8	3	2	3	730	396	Non responses
795	15 475	103	2 869	1 709	2 041	878	1 600	10 953	Not seeking a job because:
.	.	.	.	4	Awaiting recall to work (lay-off)
7	1 065	3	229	35	283	95	55	1 220	Own illness or disability
31	5 956	64	1 167	391	455	89	63	2 297	Personal/family responsibilities
22	2 071	15	220	215	398	96	338	705	Education or training
.	3 965	12	1 209	940	643	530	846	5 840	Retirement
.	501	.	44	10	9	25	27	38	Belief that no work is available
7	1 263	(1)	.	110	237	38	66	457	Other reasons
727	653	9	.	3	16	(4)	204	396	No reason
800	16 340	103	3 005	1 728	2 045	913	1 601	11 088	All in Inactivity

(1) 1998.

(2) Greece 1998, Belgium 1998.

(3) Belgium 1998.

Table 66

Main characteristics of inactivity by region

REGION	ALL INACTIVE	INACTIVE AGE 15-24	INACTIVE AGE 25-54	INACTIVE AGE 15-64	INACTIVE AGED 65+	INACTIVE NATI.	INACTIVE EU - NON- NATI.	INACTIVE NON-EU - NON-NATI.
	(Thousands)	(% all Pop.)	(% all Pop.)	(% all Pop.)	(% all Pop.)	(% all Inactive)	(% all Inactive)	(% all Inactive)
BELGIQUE-BELGIE	5 848	67.1	28.2	35.4	98.1	91.3	4.6	4.2
Bruxelles-Cap-BrusselsHf.gewest	552	70.9	28.1	36.1	97.4	73.1	10.3	16.6
Antwerpen	945	68.6	28.7	35.9	99.5	91.4	2.5	6.1
Limburg (B)	449	66.1	31.3	38.1	98.7	93.0	4.7	2.3
Oost-Vlaanderen	750	58.9	27.5	33.2	97.4	96.3	(0.3)	3.3
Vlaams Brabant	550	69.8	23.4	31.6	98.6	95.1	3.4	1.5
West-Vlaanderen	635	64.0	26.5	33.5	98.2	98.7	0.8	(0.4)
Brabant Wallon	197	70.0	26.3	34.7	98.6	94.5	4.0	(1.5)
Hainaut	775	71.3	32.3	39.8	97.2	86.6	9.4	4.0
Liège	590	65.7	28.7	35.6	97.7	90.9	7.9	1.2
Luxemburg (B)	143	66.0	27.5	35.2	96.8	95.5	3.5	
Namur	257	72.1	27.5	36.2	97.8	95.9	2.5	(1.4)
DANMARK	2 428	26.7	17.8	19.4	98.1	95.4	0.5	4.1
DEUTSCHLAND	41 312	49.2	25.0	28.8	97.4	91.3	1.8	6.9
Stuttgart	1 907	46.3	22.5	26.3	96.0	85.8	4.3	10.0
Karlsruhe	1 353	53.4	23.4	28.2	97.1	88.7	2.7	8.5
Freiburg	1 064	53.5	23.8	28.6	95.6	90.7	2.9	6.4
Tübingen	867	48.7	23.1	27.3	95.8	90.4	2.3	7.3
Oberbayern	1 657	43.5	21.9	25.1	94.6	88.9	3.9	7.2
Niederbayern	560	36.9	24.1	26.1	95.8	94.7	.	4.7
Oberpfalz	533	42.3	24.1	27.1	95.3	96.3	.	3.0
Oberfranken	552	43.4	22.9	26.3	97.1	94.4	.	4.8
Mittelfranken	824	45.1	23.3	26.7	96.2	90.7	2.4	6.9
Unterfranken	665	46.0	24.4	28.0	97.1	93.8	.	5.0
Schwaben	841	42.9	22.3	25.6	94.4	91.3	1.2	7.5
Berlin-West, Stadt	1 061	57.6	27.1	31.5	97.0	82.1	1.4	16.5
Berlin-Ost, Stadt	558	46.9	20.1	24.7	98.7	93.7	.	5.4
Brandenburg	1 200	47.8	20.3	25.4	98.7	99.4	.	.
Bremen	352	53.7	28.5	32.3	97.8	86.0	.	12.4
Hamburg	830	51.0	23.8	27.9	97.2	83.9	3.0	13.1
Darmstadt	1 843	50.3	24.2	27.9	97.8	84.6	3.5	11.8
Gießen	549	52.4	26.8	31.1	95.9	90.9	.	7.9
Kassel	677	50.3	26.5	30.2	98.2	93.1	.	6.0
Mecklenburg-Vorpommern	840	43.5	21.2	25.4	98.4	99.6	.	.
Braunschweig	891	50.2	28.4	31.8	97.9	92.3	1.3	6.4
Hannover	1 120	53.8	26.1	30.0	97.6	91.5	1.3	7.2
Lüneburg	858	53.1	26.2	30.3	96.3	94.7	.	4.6
Weser-Ems	1 274	50.7	28.0	31.6	97.3	94.1	0.9	5.0
Düsseldorf	2 813	53.8	30.2	33.5	97.8	86.4	2.5	11.0
Köln	2 248	53.1	29.2	32.9	97.9	87.2	2.9	9.8
Münster	1 411	49.2	30.7	33.8	98.6	90.8	1.0	8.2
Detmold	1 079	52.8	25.8	30.4	97.9	92.1	2.0	5.8
Arnsberg	2 083	54.9	29.5	33.5	98.3	88.3	2.3	9.4
Koblenz	802	49.2	28.8	32.0	98.0	94.4	.	4.9
Trier	276	49.9	28.9	32.5	97.5	94.9	.	4.2
Rheinhausen-Pfalz	1 021	52.3	25.3	29.3	97.9	90.4	2.7	6.9
Saarland	574	54.1	30.8	34.3	98.3	91.8	2.7	5.5
Sachsen	2 128	44.5	19.7	24.1	98.7	99.6	.	0.4
Dessau	266	46.9	21.3	25.7	99.4	99.1	.	.
Halle	425	49.4	21.2	26.0	99.7	99.3	.	.
Magdeburg	575	42.5	19.6	23.6	99.1	99.2	.	.
Schleswig-Holstein	1 390	47.9	25.6	28.8	95.6	94.7	1.0	4.3
Thüringen	1 124	47.8	19.2	24.2	98.5	99.4	.	.
ELLADA⁽¹⁾	5 843	60.0	31.7	37.5	93.6	97.9	0.1	2.0
Anatoliki Makedonia, Thraki	294	49.8	30.4	34.0	93.8	99.2	.	.
Kentriki Makedonia	1 002	62.0	33.5	39.5	95.7	98.5	.	1.5
Dytiki Makedonia	162	56.7	33.7	37.8	96.7	99.0	.	.
Thessalia	411	59.9	29.9	35.7	91.8	99.0	.	(0.8)
Ipeiros	174	66.2	33.5	40.6	93.1	99.1	.	.
Ionia Nisia	96	62.8	28.0	34.4	85.2	97.4	.	.
Dytiki Ellada	375	61.9	30.3	37.4	91.6	98.8	.	(1.1)
Sτέρα Ellada	288	53.6	35.1	38.7	91.3	99.4	.	.

⁽¹⁾ 1998.

Table 66

Main characteristics of inactivity by region

INACTIVE NOT WILL. TO WORK (% all Inactive)	INACTIVE WILLING TO WORK (% all Inactive)	INACTIVE IN EDU-CATION (% all Inactive)	INACTIVE IN RETIRE-MENT (% all Inactive)	INACTIVE DUE TO FAM.RESP (% all Inactive)	INACTIVE THINKING NO WORK (% all Inactive)	INACTIVE DUE TO ILLNESS (% all Inactive)	INACTIVE OTHER REASONS (% all Inactive)	REGION
94.1 ⁽¹⁾	5.9 ⁽¹⁾	17.6 ⁽¹⁾	49.6 ⁽¹⁾	16.2 ⁽¹⁾	1.7 ⁽¹⁾	6.5 ⁽¹⁾	8.5 ⁽¹⁾	BELGIQUE-BELGIE
92.1 ⁽¹⁾	7.9 ⁽¹⁾	20.4 ⁽¹⁾	49.1 ⁽¹⁾	11.8 ⁽¹⁾	2.4 ⁽¹⁾	7.9 ⁽¹⁾	8.4 ⁽¹⁾	Bruxelles-CapBrusselsHfgewest
97.8 ⁽¹⁾	2.2 ⁽¹⁾	16.6 ⁽¹⁾	47.1 ⁽¹⁾	23.9 ⁽¹⁾	1.7 ⁽¹⁾	4.6 ⁽¹⁾	6.1 ⁽¹⁾	Antwerpen
97.8 ⁽¹⁾	2.2 ⁽¹⁾	17.1 ⁽¹⁾	40.6 ⁽¹⁾	25.2 ⁽¹⁾	(1.0) ⁽¹⁾	7.8 ⁽¹⁾	8.1 ⁽¹⁾	Limburg (B)
91.8 ⁽¹⁾	8.2 ⁽¹⁾	16.7 ⁽¹⁾	52.8 ⁽¹⁾	12.1 ⁽¹⁾	1.1 ⁽¹⁾	6.0 ⁽¹⁾	11.2 ⁽¹⁾	Oost-Vlaanderen
91.7 ⁽¹⁾	8.3 ⁽¹⁾	18.5 ⁽¹⁾	53.9 ⁽¹⁾	12.8 ⁽¹⁾	1.5 ⁽¹⁾	6.1 ⁽¹⁾	7.1 ⁽¹⁾	Vlaams Brabant
90.5 ⁽¹⁾	9.5 ⁽¹⁾	16.2 ⁽¹⁾	53.0 ⁽¹⁾	14.0 ⁽¹⁾	1.6 ⁽¹⁾	7.0 ⁽¹⁾	8.1 ⁽¹⁾	West-Vlaanderen
94.7 ⁽¹⁾	5.3 ⁽¹⁾	24.2 ⁽¹⁾	46.9 ⁽¹⁾	11.1 ⁽¹⁾	(1)	6.1 ⁽¹⁾	10.6 ⁽¹⁾	Brabant Wallon
95.8 ⁽¹⁾	4.2 ⁽¹⁾	17.3 ⁽¹⁾	48.0 ⁽¹⁾	16.6 ⁽¹⁾	2.0 ⁽¹⁾	8.0 ⁽¹⁾	8.1 ⁽¹⁾	Hainaut
93.2 ⁽¹⁾	6.8 ⁽¹⁾	16.1 ⁽¹⁾	53.1 ⁽¹⁾	11.8 ⁽¹⁾	2.6 ⁽¹⁾	6.2 ⁽¹⁾	10.1 ⁽¹⁾	Liège
95.1 ⁽¹⁾	(4.8) ⁽¹⁾	18.1 ⁽¹⁾	49.3 ⁽¹⁾	16.3 ⁽¹⁾	(1)	6.0 ⁽¹⁾	9.0 ⁽¹⁾	Luxemburg (B)
94.0 ⁽¹⁾	6.0 ⁽¹⁾	19.3 ⁽¹⁾	46.7 ⁽¹⁾	16.8 ⁽¹⁾	(2.0) ⁽¹⁾	6.0 ⁽¹⁾	9.1 ⁽¹⁾	Namur
92.2	7.8	12.7	68.3	3.3	0.5	9.1	6.1	DANMARK
95.6	4.4	12.6	59.5	13.4	0.6	4.1	9.8	DEUTSCHLAND
94.6	5.4	13.2	59.0	14.8	.	3.0	9.5	Stuttgart
95.1	4.9	13.7	59.8	13.6	.	3.9	8.3	Karlsruhe
95.1	4.9	15.2	57.8	13.9	.	3.6	9.1	Freiburg
95.6	4.4	14.3	57.9	13.5	.	3.6	10.3	Tübingen
95.7	4.3	12.7	59.1	15.0	.	3.7	9.1	Oberbayern
96.0	4.0	9.9	60.9	16.5	.	3.9	8.3	Niederbayern
95.1	4.9	12.1	57.9	16.8	.	3.7	9.1	Oberplatz
95.0	5.0	10.5	63.4	12.1	.	3.5	10.2	Oberfranken
95.1	4.9	10.5	63.8	11.4	.	2.8	11.1	Mittelfranken
96.1	3.9	13.3	57.8	16.1	.	4.0	8.7	Unterfranken
96.2	3.8	11.1	61.2	15.7	.	4.2	7.6	Schwaben
90.9	9.1	15.3	56.3	8.4	.	6.4	12.9	Berlin-West, Stadt
89.2	10.8	18.3	61.9	3.3	.	6.5	8.6	Berlin-Ost, Stadt
94.1	5.9	15.0	67.1	1.8	.	8.3	6.9	Brandenburg
95.5	4.5	12.8	58.6	11.3	.	4.6	12.2	Bremen
94.9	5.1	13.8	55.8	11.6	.	4.0	14.3	Hamburg
95.0	5.0	12.4	57.1	15.5	.	3.6	11.1	Darmstadt
94.1	5.9	15.8	56.2	13.7	.	3.9	10.3	Gießen
95.7	4.3	11.6	59.2	15.3	.	3.1	10.5	Kassel
96.0	4.0	13.0	69.5	2.2	.	8.5	5.8	Mecklenburg-Vorpommern
95.2	4.8	13.2	62.6	13.0	.	3.4	7.5	Braunschweig
96.9	3.1	12.4	61.1	13.0	.	4.5	8.7	Hannover
95.8	4.2	11.7	59.9	16.2	.	4.0	7.9	Lüneburg
95.4	4.6	12.0	57.3	14.7	.	2.8	12.6	Weser-Ems
96.7	3.3	10.3	54.4	19.9	0.5	3.1	11.8	Düsseldorf
96.7	3.3	13.2	51.3	20.4	0.6	3.3	11.1	Köln
96.1	3.9	12.3	51.8	21.0	.	3.0	11.6	Münster
96.7	3.3	14.5	57.0	15.4	.	2.6	10.0	Detmold
97.2	2.8	11.9	55.8	18.7	0.9	3.0	9.8	Arnsberg
97.3	2.7	11.9	49.8	14.3	.	2.5	21.0	Koblenz
96.8	.	12.6	48.8	20.2	.	.	15.9	Trier
96.8	3.2	12.1	58.0	14.0	.	3.9	11.2	Rheinhausen-Pfalz
96.4	3.6	11.3	53.5	16.0	.	3.0	15.8	Saarland
95.1	4.9	12.0	73.1	2.9	0.6	7.0	4.4	Sachsen
95.5	.	12.2	74.1	.	.	5.5	5.7	Dessau
96.4	3.6	13.3	72.0	.	.	6.3	5.4	Halle
96.3	3.7	11.9	76.3	.	.	5.4	4.0	Magdeburg
94.9	5.1	10.3	59.4	14.0	1.5	4.1	10.8	Schleswig-Holstein
96.1	3.9	14.3	72.5	2.7	.	5.2	4.5	Thüringen
97.4	2.6	15.0	41.6	18.2	0.5	3.7	21.0	ELLADA ⁽¹⁾
95.5	4.5	10.6	49.9	15.1	.	6.7	16.9	Anatoliki Makedonia, Thraki
97.6	2.4	17.0	39.7	19.4	(0.3)	3.9	19.6	Kentriki Makedonia
96.3	(3.6)	10.0	48.6	27.9	.	4.6	7.6	Dytiiki Makedonia
97.4	2.6	12.6	44.0	20.3	.	5.1	17.3	Thessalia
96.3	3.7	14.1	51.6	16.0	.	(2.6)	14.9	Ipeiros
99.4	.	11.4	49.4	23.8	.	(4.4)	10.6	Ionía Nisia
97.8	2.2	15.3	46.1	10.8	.	3.9	23.0	Dytiki Ellada
96.2	3.8	9.6	46.9	22.5	.	4.3	15.6	Sτέρα Ellada

(1) 1998.

Table 66

Main characteristics of inactivity by region

REGION	ALL INACTIVE	INACTIVE AGE 15-24	INACTIVE AGE 25-54	INACTIVE AGE 15-64	INACTIVE AGED 65+	INACTIVE NATI.	INACTIVE EU - NON- NATI.	INACTIVE NON-EU - NON-NATI.
	(Thousands)	(% all Pop.)	(% all Pop.)	(% all Pop.)	(% all Pop.)	(% all Inactive)	(% all Inactive)	(% all Inactive)
Peloponnisos	300	54.5	28.6	33.1	89.1	98.7	.	(1.0)
Attiki	2 202	62.0	32.1	38.4	96.7	96.4	0.2	3.4
Voreio Aigaio	112	58.3	38.7	42.2	94.7	99.4	.	.
Notio Aigaio	144	51.8	34.5	38.0	94.4	99.4	.	.
Kriti	277	55.7	23.7	30.5	83.1	98.4	.	(1.4)
ESPAÑA	22 693	58.6	31.6	37.9	98.3	99.3	0.4	0.4
Galicia	1 574	65.2	29.4	37.3	98.0	99.7	(0.1)	.
Principado de Asturias	658	68.1	38.9	45.3	98.5	99.8	.	.
Cantabria	319	66.0	36.1	43.3	97.9	100.0	.	.
Pais Vasco	1 132	64.0	29.3	36.6	99.0	99.5	(0.2)	.
Comunidad Foral de Navarra	298	61.9	28.7	36.0	97.6	99.8	.	.
La Rioja	153	65.8	31.9	39.1	99.7	99.1	.	.
Aragón	676	57.2	31.7	36.9	98.6	99.5	.	.
Comunidad de Madrid	2 761	61.5	29.2	37.0	98.1	99.0	0.2	0.8
Castilla y León	1 460	66.5	31.1	38.9	98.5	99.7	(0.1)	.
Castilla-la Mancha	1 027	53.8	33.8	38.5	98.0	99.7	.	(0.2)
Extremadura	659	56.8	33.6	39.1	98.5	99.6	.	.
Cataluna	3 330	50.8	28.2	32.9	98.4	99.1	0.2	0.7
Comunidad Valenciana	2 242	53.1	31.6	36.5	98.5	98.7	1.0	0.2
Islas Baleares	408	57.2	27.0	33.1	98.3	97.4	1.8	(0.6)
Andalucia	4 350	58.5	35.9	41.7	98.4	99.5	0.3	0.1
Región de Murcia	650	56.2	34.4	39.8	99.0	99.4	.	(0.4)
Ceuta e Melilla	80	58.1	35.3	41.7	96.6	96.8	.	(3.1)
Canarias	907	59.2	33.1	39.3	96.6	98.1	1.2	0.7
FRANCE	31 534	63.9	23.4	31.2	98.9	94.5	1.6	3.9
île de France	5 683	66.8	19.0	27.8	98.5	88.7	2.8	8.5
Champagne-Ardenne	702	65.1	24.9	33.1	99.1	97.2	(0.9)	1.7
Picardie	970	61.1	24.4	31.9	99.1	94.3	1.1	4.5
Haute-Normandie	1 026	60.5	22.6	30.0	99.4	97.3	.	2.4
Centre	1 234	58.3	21.7	28.4	99.0	95.4	1.3	3.3
Basse-Normandie	729	63.1	24.3	31.8	98.5	99.1	(0.5)	.
Bourgogne	866	62.6	23.0	30.2	99.4	97.3	1.2	1.5
Nord - Pas-de-Calais	2 438	67.8	28.8	37.8	99.1	96.3	0.8	2.8
Lorraine	1 269	65.0	26.8	34.1	99.1	95.5	1.9	2.6
Alsace	872	53.1	23.3	29.0	99.5	93.0	1.9	5.1
Franche-Comté	594	61.2	23.7	30.8	99.2	94.5	(1.0)	4.3
Pays de la Loire	1 749	59.0	22.0	29.3	99.1	98.8	(0.2)	1.0
Bretagne	1 690	70.0	22.3	31.7	99.0	99.1	(0.2)	0.6
Poitou-Charentes	876	60.7	22.3	29.6	98.9	99.2	.	(0.4)
Aquitaine	1 686	65.0	24.1	31.8	98.9	97.0	2.1	1.0
Midi-Pyrénées	1 346	64.8	23.5	31.4	98.8	96.3	1.7	2.0
Limousin	384	66.3	25.3	32.8	98.4	97.7	.	(1.3)
Rhône-Alpes	2 892	62.8	22.6	30.5	99.0	92.6	2.3	5.1
Auvergne	699	65.6	26.8	33.8	98.5	97.5	1.4	(1.1)
Languedoc-Roussillon	1 217	65.0	29.2	36.7	98.7	93.1	2.2	4.7
Provence-Alpes-Côte d'Azur	2 430	61.9	27.1	33.5	98.9	93.9	1.8	4.4
Corse	172	64.1	37.8	41.9	100.0	81.2	(2.5)	16.3
Guadeloupe	-	-	-	-	-	-	-	-
Martinique	-	-	-	-	-	-	-	-
Guyane	-	-	-	-	-	-	-	-
Réunion	-	-	-	-	-	-	-	-
IRELAND	2 055	49.2	28.0	33.6	92.0	97.1	2.1	0.9
Border, Midlands and Western	567	53.6	29.4	36.1	89.5	97.2	2.2	(0.5)
Southern and Eastern	1 487	47.7	27.6	32.8	93.1	97.0	2.0	1.0
ITALIA	33 564	61.9	35.7	40.4	96.6	99.6	0.1	0.4
Piemonte	2 359	54.7	33.0	36.3	97.0	99.2	.	0.7
Valle d'Aosta	63	(53.5)	30.4	33.9	95.5	98.8	.	.
Liguria	949	56.8	35.2	38.1	97.5	99.6	.	.
Lombardia	4 889	54.1	33.1	36.5	96.2	99.0	(0.0)	0.9
Trentino - Alto Adige	498	52.8	30.5	34.3	94.8	99.5	.	.
Veneto	2 447	52.1	33.6	36.7	96.0	99.4	.	0.6

Table 66

Main characteristics of inactivity by region

INACTIVE NOT WILL. TO WORK (% all Inactive)	INACTIVE WILLING TO WORK (% all Inactive)	INACTIVE IN EDUCATION (% all Inactive)	INACTIVE IN RETIREMENT (% all Inactive)	INACTIVE DUE TO FAM.RESP (% all Inactive)	INACTIVE THINKING NO WORK (% all Inactive)	INACTIVE DUE TO ILLNESS (% all Inactive)	INACTIVE OTHER REASONS (% all Inactive)	REGION
97.9	(2.0)	8.3	57.3	17.0	.	3.2	13.7	Peloponnisos
97.4	2.6	18.1	35.2	18.0	0.4	2.6	25.7	Attiki
99.2	.	7.7	45.3	21.3	.	.	23.1	Voreio Aigaio
99.0	.	8.6	34.9	21.9	.	(3.7)	30.5	Notio Aigaio
97.5	(2.4)	15.1	47.6	12.3	.	7.0	17.7	Kriti
94.2	5.8	18.0	28.9	17.0	1.3	7.3	27.4	ESPAÑA
92.6	7.4	17.9	40.3	14.7	0.9	6.6	19.7	Galicia
95.8	4.2	18.0	35.8	8.7	1.5	3.9	32.2	Principado de Asturias
94.0	6.0	20.4	31.3	20.4	(1.1)	3.3	23.5	Cantabria
96.3	3.7	19.5	27.0	16.5	(0.4)	5.9	30.6	Pais Vasco
94.4	5.6	17.9	32.1	31.3	.	4.3	13.7	Comunidad Foral de Navarra
98.4	.	16.7	32.8	10.0	.	(2.4)	37.3	La Rioja
98.1	1.9	14.9	32.0	31.5	(0.5)	5.1	15.9	Aragón
99.2	0.8	23.4	25.1	10.5	.	2.4	38.6	Comunidad de Madrid
95.9	4.1	18.3	31.0	15.2	0.8	5.3	29.4	Castilla y León
92.8	7.2	14.6	26.0	19.4	0.8	5.2	34.0	Castilla-la Mancha
96.1	3.9	15.5	24.6	18.0	1.2	8.8	31.9	Extremadura
97.8	2.2	14.5	33.6	5.2	0.5	8.0	38.2	Cataluna
87.2	12.8	15.7	31.2	18.8	2.2	8.8	23.4	Comunidad Valenciana
98.7	(1.2)	15.3	35.3	12.7	.	7.9	28.2	Islas Baleares
90.4	9.6	19.3	23.9	24.7	3.4	10.5	18.2	Andalucia
95.4	4.6	19.4	17.3	35.6	.	17.1	10.3	Región de Murcia
80.7	19.3	21.6	16.9	28.4	.	(7.6)	23.9	Ceuta e Melilla
90.3	9.7	20.5	19.3	26.8	1.0	10.5	21.8	Canarias
98.5	1.5	19.1	0.2	0.8	0.2	0.6	79.1	FRANCE
98.5	1.5	24.7	0.3	0.6	(0.1)	0.5	73.7	île de France
98.0	2.0	19.0	.	(0.9)	.	.	79.3	Champagne-Ardenne
97.9	2.1	18.0	.	.	.	(0.6)	80.5	Picardie
98.5	1.5	18.8	.	(0.9)	.	.	79.3	Haute-Normandie
98.9	(1.0)	14.8	.	(0.4)	.	(0.6)	83.5	Centre
98.7	(1.2)	16.7	.	.	.	(0.6)	81.5	Basse-Normandie
98.5	1.5	16.5	.	(0.7)	.	.	82.0	Bourgogne
98.3	1.7	22.0	.	0.8	.	0.7	76.0	Nord - Pas-de-Calais
98.3	1.7	18.0	.	1.2	.	(0.6)	79.7	Lorraine
98.3	1.7	17.7	80.8	Alsace
98.2	(1.7)	17.8	80.4	Franche-Comté
99.1	0.9	18.9	.	0.8	.	(0.4)	79.4	Pays de la Loire
98.4	1.6	20.5	.	(0.5)	.	(0.5)	78.0	Bretagne
99.0	(0.9)	15.5	.	(0.6)	.	.	83.0	Poitou-Charentes
99.1	0.9	17.2	.	0.9	.	(0.3)	81.3	Aquitaine
98.7	1.3	18.9	.	(0.5)	.	(0.5)	79.7	Midi-Pyrénées
98.9	.	15.0	84.0	Limousin
98.4	1.6	20.0	(0.1)	0.6	.	(0.4)	78.6	Rhône-Alpes
98.5	(1.4)	15.3	.	.	.	(0.6)	83.1	Auvergne
98.5	1.5	17.7	.	1.3	.	1.1	79.6	Languedoc-Roussillon
98.2	1.8	15.5	.	1.0	.	1.0	82.2	Provence-Alpes-Côte d'Azur
98.6	.	9.4	89.3	Corse
-	-	-	-	-	-	-	-	Guadeloupe
-	-	-	-	-	-	-	-	Martinique
-	-	-	-	-	-	-	-	Guyane
-	-	-	-	-	-	-	-	Réunion
90.8	9.2	3.3	.	2.9	.	1.5	92.3	IRELAND
91.4	8.6	3.6	.	2.3	.	(1.2)	92.6	Border, Midlands and Western
90.6	9.4	3.1	.	3.1	.	1.5	92.2	Southern and Eastern
90.8	9.2	14.4	38.0	24.3	2.3	6.8	14.2	ITALIA
92.1	7.9	11.7	52.6	15.5	1.9	5.5	12.8	Piemonte
92.8	.	(11.3)	49.1	(15.2)	.	.	16.0	Valle d'Aosta
95.7	4.3	10.0	44.5	23.3	2.0	7.2	12.9	Liguria
90.9	9.1	13.1	45.6	23.3	1.5	5.5	11.0	Lombardia
88.9	11.1	15.7	45.5	26.0	(1.0)	4.7	7.0	Trentino - Alto Adige
90.8	9.2	12.8	40.4	28.2	1.4	5.1	12.2	Veneto

Table 66

Main characteristics of inactivity by region

REGION	ALL INACTIVE	INACTIVE AGE 15-24	INACTIVE AGE 25-54	INACTIVE AGE 15-64	INACTIVE AGED 65+	INACTIVE NATI.	INACTIVE EU - NON- NATI.	INACTIVE NON-EU - NON-NATI.
	(Thousands)	(% all Pop.)	(% all Pop.)	(% all Pop.)	(% all Pop.)	(% all Inactive)	(% all Inactive)	(% all Inactive)
Friuli - Venezia Giulia	664	58.6	34.4	37.9	96.5	99.6	.	.
Emilia-Romagna	2 102	53.9	28.9	32.6	95.7	99.4	.	0.6
Toscana	1 997	57.8	33.8	37.5	96.0	99.3	(0.1)	0.5
Umbria	483	64.0	33.4	38.4	96.8	99.5	.	.
Marche	821	60.3	31.0	36.0	97.2	99.7	.	.
Lazio	3 033	70.8	35.0	41.2	96.8	99.7	.	(0.1)
Abruzzo	777	71.0	35.7	42.3	97.4	99.8	.	.
Molise	199	66.0	35.3	41.2	97.5	99.8	.	.
Campania	3 706	68.6	41.3	47.6	97.2	99.9	.	.
Puglia	2 584	65.1	42.1	47.2	96.6	99.8	.	(0.1)
Basilicata	389	72.7	40.4	47.2	97.3	99.9	.	.
Calabria	1 308	70.8	39.5	46.4	96.9	99.9	.	.
Sicilia	3 308	66.5	43.0	48.1	97.8	99.9	.	.
Sardegna	978	66.4	37.7	43.5	96.5	99.9	.	.
LUXEMBOURG (Grand-Duché)	243	66.0	31.0	36.9	98.8	67.2	28.1	4.7
NEDERLAND	7 653	32.3	25.1	26.4	97.3	95.0	1.2	3.8
Groningen	277	35.3	27.3	28.9	96.9	97.7	.	(2.0)
Friesland	310	26.0	27.1	26.9	98.6	98.1	.	(1.6)
Drenthe	236	33.2	26.8	27.8	98.5	97.6	.	(2.3)
Overijssel	532	33.5	25.8	27.3	96.1	96.7	.	2.7
Gelderland	925	33.5	24.8	26.3	96.8	96.5	(0.6)	2.9
Flevoland	150	35.0	22.0	24.4	98.3	95.7	.	.
Utrecht	507	31.7	22.4	24.1	95.0	94.6	.	5.1
Noord-Holland	1 188	32.4	24.4	25.7	96.9	92.6	1.6	5.8
Zuid-Holland	1 660	34.0	24.9	26.6	98.1	93.0	2.1	4.9
Zeeland	187	30.5	26.2	26.9	97.5	96.6	.	.
Noord-Brabant	1 115	28.1	25.4	25.9	97.8	96.0	(0.7)	3.1
Limburg (NL)	559	34.1	26.9	28.1	97.8	94.9	2.2	2.9
ÖSTERREICH	4 062	41.6	25.7	28.4	97.2	92.0	0.9	7.1
Burgenland	143	39.1	26.8	29.0	98.4	95.8	.	3.8
Niederösterreich	782	41.1	25.8	28.5	97.1	94.7	.	5.0
Wien	762	44.0	22.6	25.7	98.7	84.1	1.1	14.7
Kärnten	302	48.2	29.0	32.4	96.0	94.8	1.3	4.0
Steiermark	624	42.8	27.7	30.4	96.3	95.7	0.4	3.9
Oberösterreich	689	37.6	26.0	28.0	97.0	93.7	0.8	5.6
Salzburg	249	42.0	23.8	27.0	97.2	90.2	1.4	8.5
Tirol	334	42.0	26.8	29.5	95.6	92.2	2.1	5.7
Vorarlberg	173	36.7	26.7	28.6	98.0	88.8	1.5	9.6
PORTUGAL	4 909	52.4	22.1	29.1	82.3	99.0	0.3	0.7
Norte	1 742	45.9	23.2	28.8	80.6	99.3	(0.1)	0.5
Centro (P)	756	56.9	16.2	25.6	63.6	98.7	0.6	0.7
Lisboa e Vale do Tejo	1 667	54.9	22.8	29.7	90.9	98.8	(0.1)	1.0
Alentejo	273	57.4	24.8	32.1	94.0	99.3	.	.
Algarve	187	62.5	20.8	29.9	89.5	98.8	.	.
Açores	144	56.5	31.8	38.7	89.9	99.4	.	.
Madeira	137	60.6	23.7	33.8	85.9	98.4	.	.
SUOMI/FINLAND ⁽²⁾	2 500	37.0	20.6	23.6	98.1	98.9	(0.0)	0.9
Uusimaa	-	-	-	-	-	-	-	-
Etelä-Suomi	-	-	-	-	-	-	-	-
Itä-Suomi	-	-	-	-	-	-	-	-
Väli-Suomi	-	-	-	-	-	-	-	-
Pohjois-Suomi	-	-	-	-	-	-	-	-
Ahvenanmaa/Åland	-	-	-	-	-	-	-	-
SVERIGE	4 456	57.7	16.0	23.6	96.3	94.7	0.8	4.5
Stockholm	-	-	-	-	-	-	-	-
Östra Mellansverige	-	-	-	-	-	-	-	-
Småland med Öarna	-	-	-	-	-	-	-	-
Sydsverige	-	-	-	-	-	-	-	-
Västsverige	-	-	-	-	-	-	-	-

⁽²⁾ Regional distribution of the population aged less than 15 years (and, for Sweden, more than 75 years), not provided.

Table 66

Main characteristics of inactivity by region

INACTIVE NOT WILL. TO WORK (% all Inactive)	INACTIVE WILLING TO WORK (% all Inactive)	INACTIVE IN EDUCATION (% all Inactive)	INACTIVE IN RETIREMENT (% all Inactive)	INACTIVE DUE TO FAM.RESP (% all Inactive)	INACTIVE THINKING NO WORK (% all Inactive)	INACTIVE DUE TO ILLNESS (% all Inactive)	INACTIVE OTHER REASONS (% all Inactive)	REGION
91.4	8.6	13.1	44.8	20.0	1.7	8.6	11.9	Friuli – Venezia Giulia
95.4	4.6	12.2	54.6	17.1	1.2	7.4	7.5	Emilia-Romagna
92.3	7.7	12.0	43.8	19.7	1.9	6.5	16.1	Toscana
90.4	9.6	13.6	40.6	22.0	(1.1)	8.0	14.5	Umbria
93.1	6.9	15.0	44.1	18.6	(1.0)	9.9	11.3	Marche
91.4	8.6	17.5	32.1	27.3	2.3	6.2	14.6	Lazio
91.7	8.3	16.2	37.6	22.9	2.8	7.2	13.2	Abruzzo
92.7	7.3	15.4	40.2	17.6	(3.2)	6.2	17.2	Molise
88.2	11.8	17.1	24.6	30.8	2.8	7.3	17.5	Campania
87.8	12.2	16.4	27.9	29.4	3.9	6.8	15.6	Puglia
86.4	13.6	18.3	35.6	17.7	5.5	8.4	14.5	Basilicata
89.0	11.0	17.2	30.1	17.4	3.3	8.3	23.7	Calabria
89.4	10.6	14.1	24.0	30.3	4.0	8.1	19.4	Sicilia
87.5	12.5	19.0	28.8	28.3	1.9	8.2	13.8	Sardegna
97.3	2.7	17.2	30.2	40.0	.	5.1	7.3	LUXEMBOURG (Grand-Duché)
88.3	11.7	8.2	48.4	27.1	1.3	10.5	4.5	NEDERLAND
86.7	13.3	9.5	45.6	25.9	.	12.0	5.9	Groningen
87.2	12.8	8.2	49.1	26.5	.	10.2	(4.0)	Friesland
90.6	9.4	(6.5)	50.9	27.6	.	8.8	(4.5)	Drenthe
86.9	13.1	8.4	47.9	27.1	.	10.4	5.2	Overijssel
88.5	11.5	8.5	48.8	27.3	(0.9)	9.0	5.4	Gelderland
85.6	14.4	(12.1)	39.8	31.2	.	(7.8)	(6.3)	Flevoland
89.4	10.6	7.2	49.9	27.2	.	10.9	4.2	Utrecht
87.6	12.4	7.4	48.5	24.0	2.0	13.2	4.8	Noord-Holland
88.6	11.4	9.7	49.1	27.1	1.2	8.6	4.3	Zuid-Holland
92.5	(7.4)	(5.9)	55.3	26.1	.	(8.4)	.	Zeeland
88.0	12.0	7.1	46.9	30.4	(1.1)	10.5	3.7	Noord-Brabant
89.5	10.5	7.3	47.5	26.4	.	13.4	4.2	Limburg (NL)
89.2	10.8	12.9	62.0	15.3	0.5	2.5	6.8	ÖSTERREICH
91.4	8.6	10.9	64.5	14.8	.	2.3	6.5	Burgenland
87.5	12.5	11.2	66.4	12.3	.	2.1	7.7	Niederösterreich
93.9	6.1	13.5	67.1	10.8	0.5	2.3	5.7	Wien
85.5	14.5	13.9	55.5	19.4	.	2.6	8.3	Kärnten
86.4	13.6	14.1	60.3	15.8	0.6	2.3	7.0	Steiermark
90.5	9.5	12.2	63.4	14.2	.	2.9	6.8	Oberösterreich
87.9	12.1	14.7	58.8	15.5	.	2.9	7.2	Salzburg
89.9	10.1	13.4	50.6	26.3	.	3.1	6.1	Tirol
86.3	13.7	13.5	54.6	24.3	.	3.2	3.9	Vorarlberg
97.3	2.7	20.7	38.5	14.9	0.4	14.3	11.2	PORTUGAL
96.8	3.2	20.0	31.3	18.4	0.7	18.0	11.5	Norte
98.1	1.9	25.6	34.9	9.7	.	21.1	8.4	Centro (P)
97.3	2.7	19.9	46.0	13.7	.	8.8	11.5	Lisboa e Vale do Tejo
97.6	2.4	16.6	49.7	10.3	.	14.6	8.3	Alentejo
98.4	.	20.6	47.1	12.1	.	7.4	12.5	Algarve
94.5	5.5	17.3	15.4	23.8	.	15.9	26.4	Açores
99.0	.	25.6	31.3	23.0	.	12.8	7.1	Madeira
89.2	10.8	10.0	57.3	6.3	2.9	14.3	9.1	SUOMI/FINLAND ⁽²⁾
-	-	-	-	-	-	-	-	Uusimaa
-	-	-	-	-	-	-	-	Etelä-Suomi
-	-	-	-	-	-	-	-	Itä-Suomi
-	-	-	-	-	-	-	-	Väli-Suomi
-	-	-	-	-	-	-	-	Pohjois-Suomi
-	-	-	-	-	-	-	-	Ahvenanmaa/Åland
93.0	7.0	20.3	53.4	2.4	1.7	3.1	19.0	SVERIGE
-	-	-	-	-	-	-	-	Stockholm
-	-	-	-	-	-	-	-	Östra Mellansverige
-	-	-	-	-	-	-	-	Småland med Öarna
-	-	-	-	-	-	-	-	Sydsverige
-	-	-	-	-	-	-	-	Västsverige

⁽²⁾ Regional distribution of the population aged less than 15 years (and, for Sweden, more than 75 years), not provided.

Table 66

Main characteristics of inactivity by region

REGION	ALL INACTIVE	INACTIVE AGE 15-24	INACTIVE AGE 25-54	INACTIVE AGE 15-64	INACTIVE AGED 65+	INACTIVE NATI.	INACTIVE EU - NON- NATI.	INACTIVE NON-EU - NON-NATI.
	(Thousands)	(% all Pop.)	(% all Pop.)	(% all Pop.)	(% all Pop.)	(% all Inactive)	(% all Inactive)	(% all Inactive)
Norra Mellansverige	-	-	-	-	-	-	-	-
Mellersta Norrland	-	-	-	-	-	-	-	-
Övre Norrland	-	-	-	-	-	-	-	-
UNITED KINGDOM	29 366	37.1	22.3	24.9	94.7	96.3	1.4	2.4
Tees Valley & Durham	628	44.4	27.5	30.8	96.8	99.2	.	.
Northumbria, Tyne and Wear	791	46.0	28.7	31.9	96.3	98.6	.	.
Cumbria	242	34.1	24.9	26.5	94.4	99.7	.	.
Cheshire	482	33.1	23.5	25.2	95.4	99.1	.	.
Greater Manchester	1 334	39.8	24.3	27.3	96.8	96.7	1.6	1.7
Lancashire	740	38.5	23.0	25.8	96.7	98.0	.	.
Merseyside	814	48.4	31.3	34.5	96.5	98.2	.	.
East Riding & North Lincolnshire	463	38.1	24.4	27.2	96.5	98.9	.	.
North Yorkshire	358	25.7	21.5	22.2	96.5	99.7	.	.
South Yorkshire	677	40.0	25.8	28.2	97.0	98.6	.	.
West Yorkshire	1 082	38.0	23.1	25.9	95.8	96.1	1.2	2.7
Derbyshire, Nottinghamshire	1 016	33.6	23.1	24.9	97.0	98.7	.	.
Leicestershire, Northamptonshire	727	35.1	17.2	20.5	94.7	98.1	.	1.4
Lincolnshire	302	37.2	22.6	25.0	92.3	99.3	.	.
Herefordsh.,Worcestersh.&Warks	559	33.3	17.6	20.3	92.8	98.8	.	.
Shropshire, Staffordshire	710	32.2	19.7	21.8	96.2	98.6	.	.
West Midlands	1 377	41.3	24.1	27.5	96.5	94.8	1.9	3.2
East Anglia	1 059	31.9	20.1	22.2	94.7	96.8	1.1	2.1
Bedfordshire, Hertfordshire	732	34.2	18.2	21.0	92.7	95.7	1.5	2.9
Essex	752	32.8	20.1	22.2	92.7	97.8	.	1.4
Inner London	1 356	44.4	25.5	28.7	93.3	81.4	4.6	14.0
Outer London	2 060	34.9	20.0	22.7	93.0	89.9	2.9	7.2
Berkshire,Bucks,Oxfordshire	917	32.0	16.0	18.9	91.8	95.8	1.6	2.6
Surrey, East-West Sussex	1 184	33.3	17.2	20.0	93.2	96.2	1.5	2.3
Hampshire, Isle of Wight	810	33.7	17.7	20.4	93.2	97.2	1.3	1.5
Kent	756	34.4	20.0	22.5	93.6	98.0	.	.
Avon,Gloucestersh.,Wiltsh.&NS	996	30.0	17.3	19.6	92.2	97.9	1.3	.
Dorset, Somerset	567	30.9	19.0	20.9	91.6	98.1	.	.
Cornwall & Isles of Scilly	254	32.7	25.7	26.8	94.8	99.1	.	.
Devon	523	32.0	19.8	22.0	94.7	98.8	.	.
West Wales & the Valleys	1 032	39.0	30.5	32.1	97.7	99.0	.	.
East Wales	553	40.3	22.8	26.2	91.6	97.8	.	.
North Eastern Scotland	189	28.0	15.5	17.9	91.7	99.2	.	.
Eastern Scotland	933	37.6	21.3	24.3	95.3	98.7	.	.
South Western Scotland	1 257	42.3	29.3	31.7	96.8	95.4	1.9	2.7
Highlands, Islands	212	31.3	20.3	22.1	93.6	99.8	.	.
Northern Ireland	905	47.4	27.8	32.2	93.6	97.1	2.4	.

Table 66

Main characteristics of inactivity by region

INACTIVE NOT WILL. TO WORK <i>(% all Inactive)</i>	INACTIVE WILLING TO WORK <i>(% all Inactive)</i>	INACTIVE IN EDU- CATION <i>(% all Inactive)</i>	INACTIVE IN RETIRE- MENT <i>(% all Inactive)</i>	INACTIVE DUE TO FAM.RESP <i>(% all Inactive)</i>	INACTIVE THINKING NO WORK <i>(% all Inactive)</i>	INACTIVE DUE TO ILLNESS <i>(% all Inactive)</i>	INACTIVE OTHER REASONS <i>(% all Inactive)</i>	REGION
-	-	-	-	-	-	-	-	Norra Mellansverige
-	-	-	-	-	-	-	-	Mellersta Norrland
-	-	-	-	-	-	-	-	Övre Norrland
86.8	13.2	8.3	55.2	14.5	0.6	15.6	5.8	UNITED KINGDOM
83.3	16.7	8.1	49.5	12.4	.	24.1	5.4	Tees Valley & Durham
85.9	14.1	7.7	52.8	13.0	.	19.6	6.4	Northumbriand, Tyne and Wear
83.3	16.7	.	58.7	11.5	.	21.2	.	Cumbria
89.6	10.4	7.7	55.0	14.2	.	15.9	6.5	Cheshire
85.2	14.8	9.1	49.7	14.3	.	21.1	5.2	Greater Manchester
88.5	11.5	8.1	57.6	12.2	.	16.7	4.7	Lancashire
85.8	14.2	9.4	51.2	14.3	.	19.9	4.3	Merseyside
85.8	14.2	9.5	54.2	17.0	.	13.2	5.4	East Riding & North Lincolnshire
91.0	9.0	.	67.1	14.8	.	8.6	5.1	North Yorkshire
83.1	16.9	7.3	51.5	14.0	.	20.4	6.2	South Yorkshire
85.5	14.5	8.8	53.7	14.8	.	17.0	5.4	West Yorkshire
88.2	11.8	7.0	59.3	13.1	.	16.4	4.0	Derbyshire, Nottinghamshire
89.0	11.0	8.6	57.2	15.3	.	11.7	6.6	Leicestershire, Northamptonshire
84.4	15.6	.	54.9	16.2	.	17.1	6.5	Lincolnshire
89.7	10.3	6.2	62.6	13.2	.	11.9	5.3	Herefordsh.,Worcestersh&Warks
88.0	12.0	6.2	58.6	13.0	.	15.6	6.4	Shropshire, Staffordshire
87.4	12.6	9.2	51.9	15.8	.	16.6	6.2	West Midlands
91.0	9.0	6.5	62.1	14.5	.	10.6	6.0	East Anglia
87.3	12.7	7.9	58.6	15.2	.	11.4	6.7	Bedfordshire, Hertfordshire
89.1	10.9	7.0	60.5	15.5	.	11.3	5.6	Essex
78.6	21.4	13.1	38.2	20.8	.	17.3	9.5	Inner London
85.5	14.5	9.8	54.0	17.0	.	12.1	6.4	Outer London
91.1	8.9	9.3	57.4	14.2	.	10.7	8.3	Berkshire,Bucks,Oxfordshire
89.6	10.4	5.9	65.6	12.8	.	8.4	6.8	Surrey, East-West Sussex
89.5	10.5	9.2	62.0	13.4	.	10.1	4.6	Hampshire, Isle of Wight
85.2	14.8	5.6	59.3	15.4	.	11.9	7.2	Kent
89.0	11.0	6.1	62.5	12.9	.	11.8	6.2	Avon,Gloucestersh.,Wiltsh.&NS
90.0	10.0	4.5	68.1	10.8	.	9.9	6.1	Dorset, Somerset
88.1	11.9	.	58.9	15.4	.	14.8	.	Cornwall & Isles of Scilly
86.4	13.6	7.0	62.4	12.8	.	11.1	5.9	Devon
84.3	15.7	5.6	51.9	13.7	.	23.2	5.0	West Wales & the Valleys
87.8	12.2	8.3	55.1	14.7	.	15.8	5.5	East Wales
84.2	15.8	.	53.0	14.7	.	16.6	.	North Eastern Scotland
86.5	13.5	9.0	57.1	11.3	.	16.8	5.0	Eastern Scotland
83.9	16.1	12.4	46.4	12.9	.	23.7	4.0	South Western Scotland
90.4	9.6	.	63.8	9.7	.	16.1	.	Highlands, Islands
88.3	11.7	13.4	42.3	18.7	.	20.5	4.4	Northern Ireland

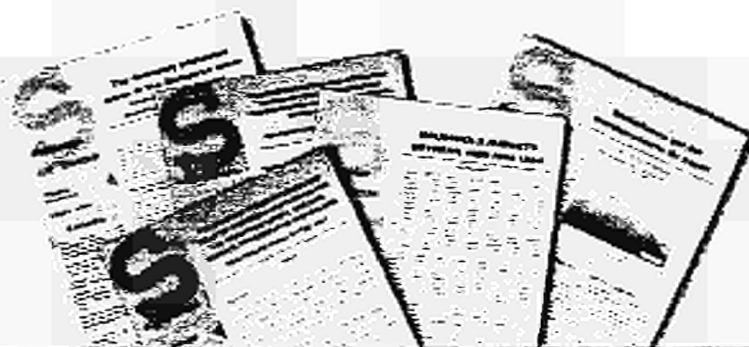

Statistics in focus

To get straight to the heart of the matter and obtain an effective insight into the reality of the EU Member States, the series of documents entitled *Statistics in focus* offers you rapid and easy access to information on all current trends in Europe.

Statistics in focus: find out, understand and decide in confidence with:

- ★ harmonized, reliable and comparable data on each Member State of the European Union;
- ★ clear and concise comments and analyses;
- ★ charts and maps easy to understand;
- ★ the latest available data.

Statistics in focus is available as single copy or by subscription. Subscriptions are available for one single theme (except themes 7 and 9) or for the whole collection. *Statistics in focus* is available as printed version or as PDF-file sent by e-mail.

Prices on request from the Data Shop network (see end of the publication).

Eurostat essentials.....

Understand today's Europe to anticipate the future better

- ★ **Eurostat Yearbook:** a comprehensive statistical presentation supplemented by comparative data for the EU's main trading partners (CD-ROM version available).
- ★ **Money, finance and the euro: Statistics:** This monthly statistical document provides short-term series for a wide range of financial indicators such as interest rates, exchange rates, money supply and official reserves (quarterly CD-ROM version available).
- ★ **Europroms CD-ROM:** the only source of information in Europe to propose detailed and comparable data on output, external trade and the markets of several thousand industrial products.
- ★ **Services in Europe:** an overview of the companies active in the service sector including detailed sectoral, thematic and country analysis.
- ★ **Agriculture and fisheries: Statistical yearbook 1998:** the most important elements of Eurostat's publications on agriculture, forestry and fisheries in abbreviated form.
- ★ **Comext CD-ROM:** provides data on external trade on all goods imported into or exported from the statistical territory of the European Union or traded between the statistical territories of the Member States.
- ★ **Transport development in the central European countries (analysis of the trends for the years 1994 and 1995):** a statistical overview of transport in 11 central European countries, together with a review of data availability.
- ★ **Energy — monthly statistics:** With the help of graphs, these statistics cover updates of the principal statistical series characterising short-term trends in the energy sectors (coal, oil, gas, electrical energy).



New Cronos:

More than 160 million items of data in this macroeconomic and social database are available to all those who need high-quality statistical information for decision-making.

Regio:

Eurostat's database for regional statistics. Covers the main aspects of economic and social life in the Community; demography, economic accounts, employment, etc.

Comext:

The database for statistics on the European Union's external trade and trade between Member States. 11 000 products by year are covered with all partner countries (more or less 250).









Europroms:

The only source of information in Europe that supplies detailed and comparable data on output, external trade and markets of several thousand industrial products. It makes it possible to calculate in precise terms the domestic market for some 5 000 products for most EU countries.

For further information, contact the Eurostat Data Shop network or visit us on the Internet at: www.europa.eu.int/comm/eurostat/

Order Form

In each column, tick the appropriate box.

Title	Catalogue No	Languages	Support	Price in EUR (except VAT and carriage)
 Eurostat Yearbook 1998-99	CA-17-98-192-**-C CA-17-98-192-1A-Z	<input type="checkbox"/> DA <input type="checkbox"/> DE <input type="checkbox"/> EN <input type="checkbox"/> FR ES/DA/DE/GR/EN/FR/ IT/NL/PT/FI/SV	Paper CD-ROM	<input type="checkbox"/> 34.00 <input type="checkbox"/> 45.00
 Money, finance and the euro: Statistics (quarterly CD-ROM version available)	CA-DQ-99-000-3A-C	Multilingual: DE/EN/FR	Paper	<input type="checkbox"/> 15.00 per copy <input type="checkbox"/> Annual subscription: 150.00
 Services in Europe	CA-17-98-742-**-C	<input type="checkbox"/> DE <input type="checkbox"/> EN <input type="checkbox"/> FR	Paper	<input type="checkbox"/> 20.00
 Europroms CD-ROM	CA-16-98-796-5J-Z	Multilingual: ES/DE/EN/FR	CD-ROM	<input type="checkbox"/> 2 000.00
 Agriculture and fisheries: Statistical yearbook 1998	CA-13-98-483-3A-C	Multilingual: DE/EN/FR	Paper	<input type="checkbox"/> 15.00
 Comext CD-ROM	CA-CK-99-0**-3A-Z	Multilingual: DE/EN/FR	CD-ROM	<input type="checkbox"/> 700.00 unit price. For details on the annual subscription, please contact the Data Shop network
 Transport development in the central European countries	CA-12-98-102-EN-C	EN	Paper	<input type="checkbox"/> 22.00
 Energy — monthly statistics	CA-BX-99-000-3A-C	Multilingual: DE/EN/FR	Paper	<input type="checkbox"/> 11.00 <input type="checkbox"/> Annual subscription: 102.00

Free information sources

★ *Statistical references* — the information letter on Eurostat products and services (yearly subscription/4 issues).

I would like to receive this free product in:
 DE EN FR

★ *Eurostat mini-guide* — Eurostat's reference catalogue.

I would like to receive this free product in:
 DE EN FR

★ *Facts through figures* — A summary of the Eurostat Yearbook.

I would like to receive this free product in:
 ES DA DE GR FI EN FR
 IT NL PT FI SV IS NO
(As long as stock lasts)

MR MRS MS (Please use block capitals)

Name: _____ Forename: _____

Firm: _____ Department: _____

Position: _____

Address: _____

Postcode: _____ Town: _____

Country: _____

Tel.: _____ Fax: _____

E-mail: _____

Please indicate your market sector:

- Education/Training
 European institution
 Politics (embassy, ministry, administration)
 Non-European statistics service
 Private user Enterprise
 Information brokerage (information service, media, consultancy, bookshop, library, etc.)
 European statistics service
 Other (please specify): _____

Payment on receipt of invoice, preferably by:

- Bank transfer Visa Euro Card
 Card No: _____ Expiry date:
 Other

Please confirm your intra-Community VAT number:

If no number is entered, VAT will be automatically applied. Credit notes will not be drawn up subsequently.

PLACE: _____ DATE: _____

SIGNATURE: _____

To be returned to the Data Shop or sales office of your choice.
Please do not hesitate to visit our Internet site at:
www.europa.eu.int/comm/eurostat/
should you require further information.

European Commission

European social statistics – Labour force survey results 1999

Luxembourg: Office for Official Publications of the European Communities

2000 — 219 pp. — 21 x 29.7 cm

Theme 3: Population and social conditions

Collection: Detailed tables

ISBN 92-828-9037-6

Price (excluding VAT) in Luxembourg: EUR 29.50

..... Eurostat Data Shops

BELGIQUE/BELGIË

Eurostat Data Shop
Bruxelles / Brussel
Planistat Belgique
124 Rue du Commerce
Handelsstraat 124
B-1000 Bruxelles/Brussel
Tel. (32-2)-234 67 50
Fax (32-2)-234 67 51
E-mail: datashop@planistat.be

DANMARK

Danmarks Statistik
Bibliotek og Information
Eurostat Data Shop
Sejrøgade 11
DK - 2100 KØBENHAVN Ø
Tel. (45-39) 17 30 30
Fax (45-39) 17 30 03
E-mail: bib@dst.dk

DEUTSCHLAND

Statistisches Bundesamt
Eurostat Data Shop Berlin
Otto-Braun-Straße 70-72
D - 10178 BERLIN
Tel. (49-30)-2324 6427/28
Fax (49-30)-2324 6430
E-mail:
datashop@statistik-bund.de

ESPAÑA

INE
Eurostat Data Shop
Paseo de la Castellana 183
Oficina 009
Entrada por Estébanez
Calderón
E - 28046 MADRID
Tel. (34-91)-583 91 67
Fax (34-91)-579 71 20
E-mail:
datashop.eurostat@ine.es

FRANCE

INSEE Info Service
Eurostat Data Shop
195, rue de Bercy
Tour Gamma A
F - 75582 PARIS CEDEX 12
Tel. (33-1)-53 17 88 44
Fax (33-1)-53 17 88 22
E-mail: datashop@insee.fr

ITALIA — ROMA

ISTAT — Centro di Informazione
Statistica — Sede di Roma
Eurostat Data Shop
Via Cesare Balbo 11a
I - 00184 ROMA
Tel. (39-06)-46 73 31 02/06
Fax (39-06)-46 73 31 01/07
E-mail: dipdiff@istat.it

ITALIA — MILANO

ISTAT — Ufficio Regionale per la
Lombardia
Eurostat Data Shop
Via Fieno 3
I - 20123 MILANO
Tel. (39-02)-8061 32 460
Fax (39-02)-8061 32 304
E-mail: Mileuro@tin.it

LUXEMBOURG

Eurostat Data Shop Luxembourg
BP 453
L - 2014 LUXEMBOURG
4, rue A. Weicker
L - 2721 LUXEMBOURG
Tel. (352) 43 35 22-51
Fax (352)-43 35 22 221
E-mail:
dslux@eurostat.datashop.lu

NEDERLAND

Statistics Netherlands
Eurostat Data Shop - Voorburg
po box 4000
NL - 2270 JM VOORBURG
Tel. (31-70)-337 49 00
Fax (31-70)-337 59 84
E-mail: datashop@cbs.nl

PORTUGAL

Eurostat Data Shop Lisboa
INE / Serviço de Difusão
Av. António José de Almeida, 2
P - 1000-043 LISBOA
Tel. (351 21) 842 61 00
Fax (351 21) 842 63 64
E-mail: data.shop@ine.pt

SUOMI/FINLAND

Statistics Finland
Eurostat Data Shop Helsinki
Tilastokirjasto
PL 2B
00022 Tilastokeskus
Työpajakatu 13 B, 2 krs,
Helsinki
Tel. (358 9)-1734 22 21
Fax (358 9)-1734 22 79
E-mail: datashop.tilastokeskus@
tilastokeskus.fi
Internet:
<http://www.tilastokeskus.fi/tk/kk/datashop.html>

SVERIGE

Statistics Sweden
Information service
Eurostat Data Shop
Karlavägen 100
Box 24 300
S - 104 51 STOCKHOLM
Tel. (46-8)-5069 48 01
Fax (46-8)-5069 48 99
E-mail: info@scb.se
URL: <http://www.scb.se/info/datashop/eudatashop.asp>

UNITED KINGDOM

Eurostat Data Shop
Enquiries & advice and publica-
tions
Office for National Statistics
Customers and Electronic
Services
Unit B1/05
1 Drummond Gate
UK - LONDON SW1V 2QQ
Tel. (44-171)-533 56 76
Fax (44-1633)-81 27 62
E-mail:
eurostat.datashop@ons.gov.uk
Electronic Data Extractions,
enquiries & advice
r.cade
1L Mountjoy Research Centre
University of Durham
UK-Durham DH1 3SW
Tel. (44-191) 374 7350
Fax (44-191) 384 4971
E-mail: r-cade@dur.ac.uk
Internet: <http://www-rcade.dur.ac.uk>

NORGE

Statistics Norway
Library and Information Centre
Eurostat Data Shop
Kongens gate 6
P.O.Box 8131 Dep.
N-0033 OSLO
Tel: (47-22) 86 46 43
Fax: (47-22) 86 45 04
E-mail: Datashop@ssb.no

SCHWEIZ/SUISSE/SVIZZERA

Statistisches Amt des Kantons
Zürich
Eurostat Data Shop
Bleicherweg 5
CH-8090 Zürich
Tel. (41 1) 225 12 12
Fax (41 1) 225 12 99
E-mail: datashop@zh.ch
Internet:
<http://www.zh.ch/statistik>

UNITED STATES OF AMERICA

Haver Analytics
Eurostat Data Shop
60 East 42nd Street
Suite 3310
NEW YORK, NY 10165
Tel. (1-212)-986 9300
Fax (1-212)-986 5857
E-mail: eurodata@haver.com

EUROSTAT HOMEPAGE

www.europa.eu.int/comm/eurostat/

MEDIA SUPPORT

EUROSTAT

(only for professional journalists)
Postal address:
Jean Monnet building
L-2920 LUXEMBOURG
Office: Bech Building — A3/48
5, rue Alphonse Weicker
L-2721 Luxembourg
Tel. (352) 43 01-33408
Fax (352) 43 01-32649
E-Mail: media.support@cec.eu.int

BELGIOUE/BELGIE

Jean De Lannoy
Avenue du Roi 202/Koningslaan 202
B-1190 Bruxelles/Brussel
Tel. (32-2) 538 43 08
Fax (32-2) 538 08 41
E-mail: jean.de.lannoy@infoboard.be
URL: <http://www.jean-de-lannoy.be>

**La librairie européenne/
De Europese Boekhandel**

Rue de la Loi 244/Welstraat 244
B-1040 Bruxelles/Brussel
Tel. (32-2) 295 25 39
Fax (32-2) 735 03 60
E-mail: mail@libeurop.be
URL: <http://www.libeurop.be>

Moniteur belge/Belgisch Staatsblad

Rue de Louvain 40-42/Leuvenseweg 40-42
B-1000 Bruxelles/Brussel
Tel. (32-2) 552 22 11
Fax (32-2) 511 01 84

DANMARK

J. H. Schultz Information A/S

Herstedvang 12
DK-2620 Albertslund
Tlf. (45) 43 63 23 00
Fax (45) 43 63 19 69
E-mail: schultz@schultz.dk
URL: <http://www.schultz.dk>

DEUTSCHLAND

Bundesanzeiger Verlag GmbH

Vertriebsabteilung
Amsterdamer Straße 192
D-50735 Köln
Tel. (49-221) 97 66 80
Fax (49-221) 97 66 82 78
E-Mail: vertrieb@bundesanzeiger.de
URL: <http://www.bundesanzeiger.de>

ΕΛΛΑΔΑ/GREECE

G. C. Eleftheroudakis SA

International Bookstore
Panepistimiou 17
GR-10564 Athina
Tel. (30-1) 331 41 80/1/2/3/4/5
Fax (30-1) 323 98 21
E-mail: elebooks@netor.gr

ESPAÑA

Boletín Oficial del Estado

Trafalgar, 27
E-28071 Madrid
Tel. (34) 915 38 21 11 (Libros),
913 84 17 15 (Suscrip.)
Fax (34) 915 38 21 21 (Libros),
913 84 17 14 (Suscrip.)
E-mail: clientes@com.boe.es
URL: <http://www.boe.es>

Mundi Prensa Libros, SA

Castelló, 37
E-28001 Madrid
Tel. (34) 914 36 37 00
Fax (34) 915 75 39 98
E-mail: libreria@mundiprensa.es
URL: <http://www.mundiprensa.com>

FRANCE

Journal officiel

Service des publications des CE
26, rue Desaix
F-75727 Paris Cedex 15
Tel. (33) 140 58 77 31
Fax (33) 140 58 77 00
E-mail: europublications@journal-officiel.gouv.fr
URL: <http://www.journal-officiel.gouv.fr>

IRELAND

Government Supplies Agency

Publications Section
4-5 Harcourt Road
Dublin 2
Tel. (353-1) 661 31 11
Fax (353-1) 475 27 60
E-mail: opw@iol.ie

ITALIA

Licosa Spa

Via Duca di Calabria, 1/1
Casella postale 552
I-50125 Firenze
Tel. (39) 055 64 83 1
Fax (39) 055 64 12 57
E-mail: licosa@licosa.com
URL: <http://www.licosa.com>

LUXEMBOURG

Messageries du livre SARRL

5, rue Raiffeisen
L-2411 Luxembourg
Tel. (352) 40 10 20
Fax (352) 49 06 61
E-mail: mail@mdl.lu
URL: <http://www.mdl.lu>

NETERLAND

SDU Servicecentrum Uitgevers

Christoffel Plantijnstraat 2
Postbus 20014
2500 EA Den Haag
Tel. (31-70) 378 98 80
Fax (31-70) 378 97 83
E-mail: sdu@sdu.nl
URL: <http://www.sdu.nl>

ÖSTERREICH

**Manz'sche Verlags- und
Universitätsbuchhandlung GmbH**

Kohlmarkt 16
A-1014 Wien
Tel. (43-1) 53 16 11 00
Fax (43-1) 53 16 11 67
E-Mail: bestellen@manz.co.at
URL: <http://www.manz.at>

PORTUGAL

Distribuidora de Livros Bertrand Ld.ª

Grupo Bertrand, SA
Rua das Terras dos Vales, 4-A
Apartado 60037
P-2700 Amadora
Tel. (351) 214 95 87 87
Fax (351) 214 96 02 55
E-mail: dlb@ip.pt

Imprensa Nacional-Casa da Moeda, SA

Rua da Escola Politécnica n.º 135
P-1250-100 Lisboa Codex
Tel. (351) 213 94 57 00
Fax (351) 213 94 57 50
E-mail: spoce@incm.pt
URL: <http://www.incml.pt>

SUOMI/FINLAND

**Akateeminen Kirjakauppa/
Akademiska Bokhandeln**

Keskuskatu 1/Centralgatan 1
PL/PB 128
FIN-00101 Helsinki/Helsingfors
P./tfn (358-9) 121 44 18
F./fax (358-9) 121 44 35
Sähköposti: sps@akateeminen.com
URL: <http://www.akateeminen.com>

SVERIGE

BTJ AB

Traktörvägen 11
S-221 82 Lund
Tlf. (46-46) 18 00 00
Fax (46-46) 30 79 47
E-post: btjeu-pub@btj.se
URL: <http://www.btj.se>

UNITED KINGDOM

The Stationery Office Ltd

Orders Department
PO Box 276
London SW8 5DT
Tel. (44-171) 870 60 05-522
Fax (44-171) 870 60 05-533
E-mail: book.orders@theso.co.uk
URL: <http://www.tsonline.co.uk>

ISLAND

Bokabud Larusar Blöndal

Skólavörðustíg, 2
IS-101 Reykjavík
Tel. (354) 552 55 40
Fax (354) 552 55 60
E-mail: bokabud@simnet.is

NORGE

Swets Norge AS

Ostenjoveien 18
Boks 6512 Eterstad
N-0606 Oslo
Tel. (47-22) 97 45 00
Fax (47-22) 97 45 45
E-mail: kyrtelid@swets.nl

SCHWEIZ/SUISSE/SVIZZERA

Euro Info Center Schweiz

c/o OSEC
Stampfenbachstraße 85
PF 492
CH-8035 Zürich
Tel. (41-1) 365 53 15
Fax (41-1) 365 54 11
E-mail: eics@osec.ch
URL: <http://www.osec.ch/eics>

BÄLGARIJA

Europress Euromedia Ltd

59, Blvd Vitosha
BG-1000 Sofia
Tel. (359-2) 980 37 66
Fax (359-2) 980 42 30
E-mail: Milena@mbx.cit.bg

ČESKÁ REPUBLIKA

ÚSIS

NIS-prodejna
Havelkova 22
CZ-130 00 Praha 3
Tel. (420-2) 24 23 14 86
Fax (420-2) 24 23 11 14
E-mail: voldanovaj@usiscr.cz
URL: <http://usiscr.cz>

CYPRUS

**Cyprus Chamber of Commerce
and Industry**

PQ Box 1455
CY-1509 Nicosia
Tel. (357-2) 66 95 00
Fax (357-2) 66 10 44
E-mail: demetrap@cccir.org.cy

EESTI

Eesti Kaubandus-Tööstuskoda

(Estonian Chamber of Commerce and Industry)
Toom-Kooli 17
EE-0001 Tallinn
Tel. (372) 646 02 44
Fax (372) 646 02 45
E-mail: einfo@koda.ee
URL: <http://www.koda.ee>

HRVATSKA

Mediatrade Ltd

Pavla Hatza 1
HR-10000 Zagreb
Tel. (385-1) 481 94 11
Fax (385-1) 481 94 11

MAGYARORSZAG

Euro Info Service

Hungexpo Europa Ház
PO Box 44
H-1441 Budapest
Tel. (36-1) 264 82 70
Fax (36-1) 264 82 75
E-mail: euroinfo@euroinfo.hu
URL: <http://www.euroinfo.hu>

MALTA

Miller Distributors Ltd

Malta International Airport
PO Box 25
Luqa LOA 05
Tel. (356) 66 44 88
Fax (356) 67 67 99
E-mail: gwirth@usa.net

POLSKA

Ars Polonia

Krakowskie Przedmiescie 7
Skr. pocztowa 1001
PL-00-950 Warszawa
Tel. (48-22) 826 12 01
Fax (48-22) 826 62 40
E-mail: books119@arspolona.com.pl

ROMÂNIA

Euromedia

Strada Franceza Nr 44 sector 3
RO-70749 Bucuresti
Tel. (40-1) 315 44 03
Fax (40-1) 315 44 03
E-mail: mnedelcu@pcnet.pcnet.ro

ROSSIYA

CECE

60-letiya Oktyabrya Av. 9
117312 Moscow
Tel. (7-095) 135 52 27
Fax (7-095) 135 52 27

SLOVAKIA

Centrum VTI SR

NM Slobody, 19
SK-81223 Bratislava
Tel. (421-7) 54 41 83 64
Fax (421-7) 54 41 83 64
E-mail: europ@tbb1.sltk.stuba.sk
URL: <http://www.sltk.stuba.sk>

SLOVENIJA

Gospodarski Vestnik

Dunajska cesta 5
SLO-1000 Ljubljana
Tel. (386) 613 09 16 40
Fax (386) 613 09 16 45
E-mail: europ@gvestnik.si
URL: <http://www.gvestnik.si>

TURKIYE

Dünya Infotel AS

100, Yil Mahallesi 34440
TR-80050 Bagciilar-Istanbul
Tel. (90-212) 629 46 89
Fax (90-212) 629 46 27
E-mail: infotel@dunya-gazete.com.tr

AUSTRALIA

Hunter Publications

PO Box 404
3067 Abbotsford, Victoria
Tel. (61-3) 94 17 53 61
Fax (61-3) 94 19 71 54
E-mail: jpdavies@ozemail.com.au

CANADA

Les éditions La Liberté Inc.

302C, chemin Sainte-Foy
G1X 3V6 Sainte-Foy, Québec
Tel. (1-418) 658 37 63
Fax (1-800) 567 54 49
E-mail: liberte@mediom.qc.ca

Renouf Publishing Co. Ltd

5365 Chemin Canotek Road Unit 1
K1J 9J3 Ottawa, Ontario
Tel. (1-613) 745 26 65
Fax (1-613) 745 76 60
E-mail: order.dept@renoufbooks.com
URL: <http://www.renoufbooks.com>

EGYPT

The Middle East Observer

41 Shenf Street
Cairo
Tel. (20-2) 392 69 19
Fax (20-2) 393 97 32
E-mail: inquiry@meobserver.com
URL: <http://www.meobserver.com>

INDIA

EBIC India

3rd Floor, Y. B. Chavan Centre
Gen. J. Bhosale Marg.
400 021 Mumbai
Tel. (91-22) 282 60 64
Fax (91-22) 285 45 64
E-mail: ebic@giabm01.vsnl.net.in
URL: <http://www.ebicindia.com>

JAPAN

PSI-Japan

Asahi Sanbancho Plaza #206
7-1 Sanbancho, Chiyoda-ku
Tokyo 102
Tel. (81-3) 32 34 69 21
Fax (81-3) 32 34 69 15
E-mail: books@psi-japan.co.jp
URL: <http://www.psi-japan.co.jp>

MALAYSIA

EBIC Malaysia

Level 7, Wisma Hong Leong
18 Jalan Perak
50450 Kuala Lumpur
Tel. (60-3) 21 62 62 98
Fax (60-3) 21 62 61 98
E-mail: ebic-kl@mnl.net.my

MEXICO

Mundi Prensa Mexico, SA de CV

Rio Panuco No 141
Colonia Cuauhtemoc
MX-06500 Mexico, DF
Tel. (52-5) 533 56 58
Fax (52-5) 514 67 99
E-mail: 101545.2361@compuserve.com

PHILIPPINES

EBIC Philippines

19th Floor, PS Bank Tower
Sen. Gil J. Puyat Ave. cor. Tindaio St.
Makati City
Metro Manila
Tel. (63-2) 759 66 80
Fax (63-2) 759 66 90
E-mail: eccpcom@globe.com.ph
URL: <http://www.eccp.com>

SOUTH AFRICA

Eurochamber of Commerce in South Africa

PO Box 781738
2146 Sandton
Tel. (27-11) 884 39 52
Fax (27-11) 883 55 73
E-mail: info@eurochamber.co.za

SOUTH KOREA

**The European Union Chamber
of Commerce in Korea**

5th Fl, The Shilla Hotel
202, Jangchung-dong 2 Ga, Chung-ku
100-392 Seoul
Tel. (82-2) 22 53-5631/4
Fax (82-2) 22 53-5635/6
E-mail: eucck@euccok.org
URL: <http://www.euccok.org>

SRI LANKA

EBIC Sri Lanka

Trans Asia Hotel
115 Sir chittampalam
A. Gardiner Mawatha
Colombo 2
Tel. (94-1) 074 71 50 78
Fax (94-1) 44 87 79
E-mail: ebicsl@itrim.com

THAILAND

EBIC Thailand

29 Vanissa Building, 8th Floor
Soi Chidlom
Ploenchit
10330 Bangkok
Tel. (66-2) 655 06 27
Fax (66-2) 655 06 28
E-mail: ebicbkk@ksc15.th.com
URL: <http://www.ebicbkk.org>

UNITED STATES OF AMERICA

Bernan Associates

4611-F Assembly Drive
Lanham MD20706
Tel. (1-800) 274 44 47 (toll free telephone)
Fax (1-800) 865 34 50 (toll free fax)
E-mail: query@bernan.com
URL: <http://www.bernan.com>

**ANDERE LÄNDER/OTHER COUNTRIES/
AUTRES PAYS**

**Bitte wenden Sie sich an ein Büro Ihrer
Wahl! Please contact the sales office
of your choice! Veuillez vous adresser
au bureau de vente de votre choix**
**Office for Official Publications
of the European Communities**
2, rue Mercier
L-2985 Luxembourg
Tel. (352) 29 29-42455
Fax (352) 29 29-42758
E-mail: info.info@cec.eu.int
URL: <http://eur-op.eu.int>

Price (excluding VAT) in Luxembourg: EUR 29.50



OFFICE FOR OFFICIAL PUBLICATIONS
OF THE EUROPEAN COMMUNITIES

L-2985 Luxembourg

ISBN 92-828-9037-6



9 789282 890370